



Read this "User's Guide", and keep it handy for future reference.

User's Guide HITACHI SJ Series Inverter



P1

Mandatory

Necessary

Check

Referenc

Introduction
Contents
Chapter 1 Safety Instructions/Risks
Chapter 2 Handling of This User's Guide
Chapter 3 You Can Run the Inverter after Reading This Chapter
Chapter 4 Main Body of the Product
Chapter 5 Included Items
Chapter 6 Installation
Chapter 7 Wire Connection and Optional Devices
Chapter 8 Operation Check/Residual Risks
Chapter 9 Operating
Chapter 10 Test Run
Chapter 11 Frequency References and RUN Commands Examples
Chapter 12 Inverter Functions
Chapter 13 Information Monitor Functions
Chapter 14 RS485 Communication
Chapter 15 Optional Cassettes
Chapter 16 ProDriveNext / EzSQ
Chapter 17 Connection with PLC
Chapter 18 Tips/FAQ/Troubleshooting
Chapter 19 Maintenance and Inspection
Chapter 20 Specifications
Chapter 21 Technical Notes
Appendix List of Parameters / Index

S.1 Introduction

Thank you for purchasing Hitachi SJ Series P1 Inverter. This is a User's Guide that describes the handling and maintenance of the SJ Series P1 inverter. (Afterward "Hitachi SJ Series P1 Inverter" referred as SJ-P1.)

For the purpose of reduction paper consumption and provision of the latest information, we enclose the P1 Basic Guide only, while providing the P1 User's Guide (this Guided) for more detailed description through electronic means instead of CD or a printed document.

■ About the Basic Guide (Bundled with product)

The P1 Basic Guide provides the minimum information necessary for handling the product. Be sure to read this document as well as the P1 User's Guide for more detailed information.

■ About the User's Guide (This document)

The P1 User's Guide provides detailed information necessary for handling the product. Be sure to read the User's Guide for proper use.

If there are any differences between the P1 Basic Guide and the P1 User's Guide due to updates, etc., the contents on the Guide with the latest version will have higher priority. The version of the Guide is shown in underlined alphabet like the following example, and the alphabet changes to A, B, C... by the revision. For example, comparing the Basic Guide NT2511FX and the user's Guide NT2511EX-2, the Basic Guide contains the latest contents. Always use the SJ-P1 inverter strictly within the range described in the latest contents on the Guide and perform proper inspection and maintenance to prevent failures or accidents.

Please note that the P1 User's Guide basically provided as electronic data (such as PDF).

The latest version of the P1 User's Guide, please contact the supplier where this device was purchased.

■ Handling an Optional Products

When using optional products, refer to the instruction manual, Basic Guide, User's Guide, and other related technical documents attached to the product.

Please note that, like the SJ-P1 User's Guide, some optional products may also provide the User Guide and other documents as electronic data (such as PDF).

For more details, please contact the supplier where this device was purchased.

S.2 Cautions

■ For a Proper Use

Before using the inverter, carefully read the Basic Guide, User's Guide of inverter and the instruction manuals for optional products.

In addition, any personnel handling or performing maintenance of the product must read carefully the inverter's Basic Guide, User's Guide and each optional products instruction manuals.

Before any attempt to install, operate, maintain or inspect this equipment, a complete understanding of the equipment specifications, safety instructions, precautions, handling and operation instructions is required. Follow all the specifications and instructions for a proper use. Additionally, review the inverter's Basic Guide, User's Guide and each optional product instruction manuals periodically.

■ Precautions

It is prohibited to reproduce or reform this document partially or totally in any form without the publisher's permission.

The contents of the document are subject to change without prior notice.

Any handling, maintenance or operation method NOT described on the inverter's Basic Guide, User's Guide and each optional product instruction manuals is not covered by the product warranty. DO NOT perform any procedure NOT described on the SJ-P1 and optional product guides since it can be the cause of unexpected failures or accidents.

We are not responsible for any impact from operations regardless of unexpected failure or accident due to operation or handling of the product in a manner not specified on the inverter's Basic Guide, User's Guide and each optional product instruction manuals. We appreciate your understanding.

If you find any unclear or incorrect description, missing description, or misplaced or missing pages, please inform the Hitachi inverter technical service office or the supplier where this device was purchased.

Note that, in case the inverter's Basic Guide, User's Guide and each optional product instruction manuals are enclosed, they should be delivered to the end user of the inverter. For details information, please contact the supplier where this device was purchased.

S.3 Product Warranty and Inquiry

■ About Product Inquiry

- For an inquiry about product damage or faults or a question about the product, notify your supplier or Hitachi inverter technical service office.
- When contacting the technical service, please provide the following information.

- Model: P1 followed by model code on the specification label.
- Manufacturing Number (MFG No.): It shows on the specification label.
- Date of purchase: Purchase date by customer.
- Inquiry contents:
 - Inform us the defective point and its condition.
 - Inform us the suspicious content and its detail.

■ Product Warranty

- The product SJ-P1 will be warranted by Hitachi Industrial Equipment Systems Co., Ltd. (afterwards referred as "Hitachi") during the warranty period from your date of purchase only under proper usage of product.
- However, the warranty expressed here is covered only for products delivered from Hitachi, and will not be responsible for others damage or loss of products like a motor or any equipment or systems damage caused by improper usage of the product. We recommend applying safety design which is able to provide a hazard notice to the user in case of malfunction or damage of the delivered product to minimize the consequences on other equipment or system. We advise that the selection of the delivered product is done with sufficient margin for performance, as well as using redundant design for other equipment or systems. Also, the compatibility of the product with the customer's intended use is not warranted, hence the customer has the responsibility to perform validation tests before any operation.
- In case a defective product is delivered, or quality failure during the manufacturing process are detected, Hitachi will repair or exchange the product free of charge, only during the product warranty period (afterward, we call "warranty service").
- The product will be warranted for one year from the date of purchase. However, depending on the case, actual expenses for sending technical assistance will be charged to the customer. Also, Hitachi will not be responsible of any readjustment or testing on site.
- Warranty period for repaired or replaced part based on a warranty service is 6 months after the repair is completed for the relevant part. Hitachi will be responsible for repairing or exchanging the previously exchanged or repaired part only during this warranty period.

- In order to receive warranty service, you should present the receipt issued by the product supplier or any other document that allow us to check the purchase date. However, any defects, damage, malfunction or any other failure caused by one of the following facts will not be covered by warranty service.
 - (1) Cannot confirm the purchase date.
 - (2) The damage or fault resulted from improper usage or inadequate handling of the product or usage that does not comply with the instructions described in the User's Guide or Basic Guide.
 - (3) Incorrect usage of the product and/or the inverter, inadequate setting of the product and/or the inverter, remodeling or inadequate repair or repair carried out by an unqualified repair center.
 - (4) Deterioration and wear as result of normal operation.
 - (5) Fault resulted from natural disaster, such as earthquake, fire disaster, lightning strike, pollution, salt pollution, or abnormal voltage or any others external factors.
 - (6) Shock, falling, or Vibration resulted during transportation or displacement after purchase.
 - (7) Damage or fault resulted from remodeling firmware by unqualified personal not belonging to Hitachi.
 - (8) Damage or fault resulted from using a function program (EzSQ).
- By warranty service, It is very likely that parameters and customer created EzSQ program data will be lost. Be sure to back up by own responsibility. However, in case of malfunction resulting from the circuit board of the storage devices, the backup will not be possible. It is recommended to keep a backup during the testing phase by using keypad VOP or PC software ProDriveNext.

■ Liability Limitation

- In this product warranty, all warranties offered to the customer are stipulated, and neither Hitachi, affiliated companies nor related dealers are liable to any express warranties or implied warranties including, but not limited to, product merchantability or specific application fitness.
- Also, Hitachi, affiliated companies or related dealers are not responsible of any incidental damage, special damage, direct loss, or indirect loss (even predictable or not) sustained by the customer as a result of a faulty product.

■ Using the Warranty Service

- The customer is able to receive a warranty service during the warranty period from the product supplier or local Hitachi inverter sales office, if the product does not meet the specifications described in the latest User's or Basic Guide.
- A fare-paying service can also be obtained by contacting your supplier, local Hitachi distributor, or local Hitachi inverter sales office.

■ Precautions for Product Operation

- The product should be operated following the working conditions, handling methods and precautions described in Basic Guide, User's Guide or other technical Document.
- Be sure to confirm that the Hitachi inverter is correctly configured and installed for the intended purpose in the customer designed system.
- When using the Hitachi inverter implement the take following actions.
 - (1) Select an inverter with sufficient capacity for the rated current and performance of customer facilities.
 - (2) Implement safety design such as redundant system design.
 - (3) Implement safety design which minimizes risks in case of an inverter failure.
 - (4) Design the system in a way it can warn the operator about any danger.
 - (5) Carry out periodic maintenance to the customer's equipment as well as the inverter.
- Hitachi inverter is designed and manufactured intentionally to be applied for general industrial equipment application. It is not intended to be used for the applications listed below therefore. In case inverter is used for these applications, it is out of warranty unless there is a special written agreement.
 - (1) For special application such as aircraft, spacecraft, nuclear, electric power, passenger transportation, medical, submarine repeater, etc.
 - (2) For application such as elevator, amusement equipment, medical equipment which might have a big effect on human life and property.
- Even for above application, in case there is an agreement for the limitation of the purpose and quality, please contact to our sales office. Further study will be carried out to check whether inverter is applicable for that specific application or not.
- For applications that involve human life, or have risk of important loss, be sure to avoid a critical accident by installing a fail-safe device, protecting device, detecting device, alarm device, or spare device, etc.
- This inverter is only for three phase induction motor [IM] or three phase synchronous motor (permanent-magnet motor) [SM(PMM)].
- For any other application make inquiries.

■ Change on Product Specifications

- Please be aware that the information described in Brochure, Basic Guide, User's Guide or Technical Document might be modified without notice.

■ Supplement

- Refer to "Chapter 19 Maintenance and Inspection" for short lifespan component.
- This warranty term will not restrict a legal right of customer who has purchased the product.
- Please contact your sales agent for warranty of products.

■ Contact Information

Hitachi America, Ltd. (Charlotte Office)

Industrial Components and Equipment Division
6901 Northpark Blvd., Suite A, Charlotte, NC 28216,
U.S.A

TEL : +1(704) 494-3008
FAX : +1(704) 599-4108

Hitachi Europe GmbH

Industrial Components & Equipment Group
Niederkaßeler Lohweg191, 40547 Dusseldorf,
Germany

TEL : +49-211-5283-0
FAX : +49-211-204-9049

Hitachi Asia Ltd.

Industrial Components & Equipment Division
No.30 Pioneer Crescent, #10-15 West Park Bizcentral,
Singapore 628560,
Singapore

TEL : +65-6305-7400
FAX : +65-6305-7401

Hitachi Australia Pty Ltd.

Suite 801, Level 8, 123 Epping Road, North Ryde, NSW, 2113,
Australia

TEL : +61-2-9888-4100
FAX : +61-2-9888-4188

Hitachi Industrial Equipment Systems Co., Ltd.

AKS Building, 3, Kanda
Neribeicho, Chiyoda-ku,
Tokyo, 101-0022
Japan

TEL : +81-3-4345-6529
FAX : +81-3-4345-6913

S.4 Related Basic / User's Guide

Document name	Document Number	Product bundle
SJ series P1 User's Guide (This document)	NT251*X	(*1)
SJ series P1 Basic Guide	NT2511*X	✓
SJ series P1 Safety function Guide	NT2512*X	(*1)
SJ series P1 Easy-Sequence Function(EzSQ) Programming Guide	NT252*X	(*1)
P1-FB Encoder Feedback option User's Guide	NT253*X	✓
P1-EN Ethernet Communication Option User's Guide	NT254*X	(*1)
P1-ECT EtherCAT Communication Option User's Guide	NT255*X	(*1)
P1-PB PROFIBUS Communication Option User's Guide	NT256*X	(*1)
P1-PN PROFINET Communication Option User's Guide	NT257*X	(*1)
P1-TM2 Screw type terminal Option User's Guide	NT259*X	✓
P1-TM2R Screw type terminal Option (Expanded relay) User's Guide	NT263*X	✓
P1-AG Analog Input/Output Option User's Guide	NT260*X	✓
P1-CCL CC-Link Communication Option User's Guide	NT261*X	(*1)
P1-DN DeviceNet Communication Option User's Guide	NT262*X	(*1)
P1-FS Functional Safety Option Safety Function Guide	NT2582*X	✓
ProDriveNext instruction manual(HITACHI Inverter setting software) (In preparing, please contact our sales)	NT8001*X	(*1)

(The document version ("*" is alphabet A, B,) is added to the end of document code.)

(*1) These are usually not bundled with the product but a simple Basic guide is included.

For each User's Guides, please contact the supplier where this device was purchased or local Hitachi inverter sales office.

S.5 Trademark

- CRIMPFOX® is a registered trademark of Phoenix Contact GmbH & Co. KG.
- Modbus® is a registered trademark of Schneider Automation Inc.
- EtherCAT® is registered trademark and patented technology, licensed by Beckhoff Automation GmbH, Germany.
- PROFIBUS® and PROFINET® is registered trademark of PROFIBUS Nutzerorganisation e.V. (PNO).
- CC-Link® is trade names of Mitsubishi Electric Co.
- DeviceNet® is the trademark of Open DeviceNet Vendor Association, Inc.

C.1 Contents

S.1 Introduction.....	S-1	S.4 Related Basic / User's Guide.....	S-4
S.2 Cautions	S-1	S.5 Trademark	S-4
S.3 Product Warranty and Inquiry	S-2	C.1 Contents.....	S-5

Chapter 1 Safety Instructions/Risks

1.1 What This Chapter Explains	1-1	1.5 Examples of Caution Labels	1-7
1.2 Types of Warnings	1-1	1.6 Compliance with European Directive (CE).....	1-8
1.3 Description of Safety Symbols.....	1-2	1.7 Compliance with UL Standards.....	1-10
1.4 Cautions	1-3		

Chapter 2 Handling of This User's Guide

2.1 What This Chapter Explain	2-1	2.5 Overview of the Guide	2-2
2.2 Applicable Products	2-1	2.6 Glossary.....	2-3
2.3 Before Reading the Guide	2-1	2.7 Operating Principles	2-5
2.4 Purpose of the Guide.....	2-1	2.8 Meanings of the Explanatory Symbols.....	2-6

Chapter 3 You Can Run the Inverter after Reading This Chapter

3.1 What This Chapter Explains	3-1	3.2 Flow for Preparation of Operation.....	3-2
--------------------------------------	-----	--	-----

Chapter 4 Main Body of the Product

4.1 What This Chapter Explains	4-1	4.3 Model of the Product and Specification Label.....	4-3
4.2 External Appearance of the Product.....	4-2		

Chapter 5 Included Items

5.1 What This Chapter Explains	5-1	5.3 Inspection upon Purchase	5-3
5.2 Included Items	5-2		

Chapter 6 Installation

6.1 What This Chapter Explains	6-1	6.3 External Dimensions.....	6-7
6.2 Installation Environment	6-2		

Chapter 7 Wire Connection and Optional Devices

7.1 What This Chapter Explains	7-1	7.4 Check a Terminal Connection Example	7-4
7.2 Remove the Terminal Block Cover	7-2	7.5 Connect Wire to the Main Circuit Terminal Block	7-6
7.3 Use the Backing Plate	7-3	7.6 Operation and Optional Areas.....	7-24
		7.7 Control Circuit Terminal Area	7-26

Chapter 8 Operation Check/Residual Risks

8.1 What This Chapter Explains	8-1	8.3 Sections with Residual Risks	8-2
8.2 Content of the Checklist	8-1	8.4 Residual Risk Checklist	8-3

Chapter 9 Operating

9.1 What This Chapter Explains	9-1	9.8 Change Assist Bar Information!	9-22
9.2 Start Operating the Inverter!.....	9-2	9.9 Supplementary Information.....	9-23
9.3 Let's Set Up the Parameters!	9-7	9.10 Parameter Functions	9-24
9.4 Monitor Inverter Information!	9-13	9.11 Display Fixation Function	9-39
9.5 Check Error History!	9-16	9.12 Error Operation on the Operator Keypad	9-40
9.6 Copy Data!	9-18	9.13 Prevention of Unnecessary Read/Write	9-42
9.7 System Settings!	9-20		

Chapter 10 Test Run

10.1 What This Chapter Explains	10-1	10.4 Let's Configure Settings for Test Runs!	10-4
10.2 Let's Check the Procedures Before Test Runs !..	10-2	10.5 Checking in the Simulation Mode	10-8
10.3 Settings and Commands Required for Running the Inverter	10-3		

Chapter 11 Frequency References and RUN Commands Examples

11.1 What This Chapter Explains	11-1	11.2 How to Input Each Frequency References and RUN Commands	11-1
---------------------------------------	------	---	------

Chapter 12 Inverter Functions

12.1 What This Chapter Explains	12-1-1	12.13 Functions to Prevent Trips or Restart on Trips	12-13-1
12.2 Basic Settings of Inverter.....	12-2-1	12.14 Each Start Mode Settings.....	12-14-1
12.3 Basic Settings of Motor.....	12-3-1	12.15 Each Stop Mode Settings.....	12-15-1
12.4 Selection of Frequency Reference	12-4-1	12.16 Using System Protection Functions.....	12-16-1
12.5 Selection of RUN Command	12-5-1	12.17 How to Use the Functions Interlock to the System.....	12-17-1
12.6 Limits to Frequency Reference and RUN Command.....	12-6-1	12.18 Controlling the Cooling Fan of the Inverter....	12-18-1
12.7 Temperature Protection of Motor	12-7-1	12.19 How to Output Warning Signals	12-19-1
12.8 Using Functions of Accelerating or Decelerating Motor Speed	12-8-1	12.20 How to Output Running Status Related Signals.....	12-20-1
12.9 Select the Appropriate Control Mode for the Motor and Load.....	12-9-1	12.21 How to Output the Output Frequency Specific Condition Signals.....	12-21-1
12.10 Perform Process Control Suitable for the System Using PID Control.....	12-10-1	12.22 How to detect Analog Inputs Disconnection or Out-of-Range.....	12-22-1
12.11 Perform Torque Control Suitable for the Load	12-11-1	12.23 How to Output the Logical Operation of Two Output Signals.....	12-23-1
12.12 Adjustments for Motor Electromagnetic Sound Noise, Electrical Noise, Heat Generation of Inverter.....	12-12-1	12.24 Functions with Input Terminal Signal.....	12-24-1
		12.25 Functions with Output Terminal Signal	12-25-1

Chapter 13 Information Monitor Functions

13.1 What This Chapter Explains	13-1	13.12 Checking the Result of Life Diagnosis	13-16
13.2 Checking the Frequency Data	13-2	13.13 Checking Electric Thermal Load Factor	13-18
13.3 Checking the Acceleration Time or Deceleration Time	13-6	13.14 Checking Load Factor of Braking Resistor.....	13-19
13.4 Checking the Rotational Direction	13-7	13.15 Checking the State of Mounted Option Slot.....	13-20
13.5 Checking the Input or Output of Terminals	13-8	13.16 Checking the State of Analog Switch.....	13-21
13.6 Monitoring Output Current.....	13-9	13.17 Checking the Load Type of Inverter	13-22
13.7 Monitoring Output Voltage	13-10	13.18 Checking the Rated Current of Inverter	13-22
13.8 Checking P-N Voltage (Internal DC Voltage).....	13-10	13.19 Checking the Run Command Source and Frequency Reference Source	13-23
13.9 Checking the Inverter's Operating Time and Operation Count.....	13-11	13.20 Checking the State of Inverter	13-24
13.10 Checking the Inverter Temperature	13-13	13.21 Monitoring Analog Input Information	13-26
13.11 Checking the Inverter Power Consumption.....	13-14	13.22 Monitoring Terminal Block Mounting Status.....	13-27
		13.23 Monitoring Functions Described in Other Chapters.....	13-28

Chapter 14 RS485 Communication

14.1 What This Chapter Explains	14-1	14.4 Description of Each Function Code	14-11
14.2 Modbus-RTU	14-2	14.5 EzCOM Function	14-21
14.3 Message Structure	14-7	14.6 Lists of Coils and Communication Registers.....	14-26

Chapter 15 Optional Cassettes

15.1 What This Chapter Explains	15-1	15.5 Communication Option Overview	15-4
15.2 Installation of Optional Cassettes	15-1	15.6 Terminal Extension Option Overview	15-6
15.3 Parameters Related to Optional Devices.....	15-2	15.7 Functional Safety Expansion Option Overview	15-7
15.4 Feedback Option Overview	15-3		

Chapter 16 ProDriveNext / EzSQ

16.1 What This Chapter Explains	16-1	16.3 Program Operation Function EzSQ	16-3
16.2 "ProDriveNext"	16-2	16.4 Trace Functions	16-7

Chapter 17 Connection with PLC

17.1 What This Chapter Explains	17-1	17.2 Connection with PLC	17-2
---------------------------------------	------	--------------------------------	------

Chapter 18 Tips/FAQ/Troubleshooting

18.1 What This Chapter Explains	18-1	18.5 Troubleshooting for Warning Functions Related Error	18-33
18.2 Self Diagnosis of Problems	18-2	18.6 How to Check When Something Is Wrong	18-42
18.3 Checking Error Information	18-3		
18.4 Troubleshooting for Protection Functions Related Error	18-6		

Chapter 19 Maintenance and Inspection

19.1 What This Chapter Explains	19-1	19.6 Checking Method of Inverter and Converter	19-5
19.2 Notes on Maintenance and Inspection	19-2	19.7 Smoothing Capacitor Life Curve	19-6
19.3 Daily Inspection and Periodic Inspection	19-3	19.8 Life Alarming Output	19-6
19.4 Megger Test	19-4	19.9 Measurement Method of I/O Voltage, Current, and Power	19-7
19.5 Withstand Voltage Test	19-4		

Chapter 20 Specifications

20.1 What This Chapter Explains	20-1	20.3 External Dimensions	20-7
20.2 Inverter Specifications	20-2	20.4 Current Derating	20-19

Chapter 21 Technical Notes

21.1 What This Chapter Explains	21-1	21.3 Summary of Changes in Each Version	21-28
21.2 Replacement from SJ700-2/L700	21-2	21.4 STO Terminal Functions	21-37

Appendix

List of Parameter	Appendix 1-1	Index	Appendix 2-1
		Revision History	Appendix 2-6

(Memo)

1

Chapter 1 Safety Instructions/Risks

Contents

1.1 What This Chapter Explains 1-1
 1.2 Types of Warnings 1-1
 1.3 Description of Safety Symbols 1-2
 1.4 Cautions 1-3
 1.4.1 Caution! 1-3
 1.4.2 Precautions for installation 1-3
 1.4.3 Precautions for Wiring 1-4
 1.4.4 Precautions for Running and
 Test Running 1-5
 1.4.5 Precautions for Maintenance/Daily
 Inspection 1-6
 1.4.6 Precautions for disposal 1-6
 1.4.7 Other Cautions 1-6
 1.5 Examples of Caution Labels 1-7
 1.6 Compliance with European Directive (CE) 1-8
 1.7 Compliance with UL Standards 1-10

1.1 What This Chapter Explains



This chapter includes instructions for installation, wiring, operation, maintenance, inspection and use of the inverter.

Be sure to read this User’s Guide and appended documents thoroughly before installing, wiring, operating, maintaining, inspecting or using the inverter.

1.2 Types of Warnings

In the User’s Guide, the severity levels of safety precautions and residual risks are classified as follows: “DANGER”, “WARNING” and “CAUTION”.

Display meaning

 DANGER
Indicates that incorrect handling may cause hazardous situations, which have a high chance of resulting in serious personal injury or death, and may result in major physical loss or damage.
 WARNING
Indicates that incorrect handling may cause hazardous situations, which may result in serious personal injury or death, and may result in major physical loss or damage.
 CAUTION
Indicates that incorrect handling may cause hazardous situations, which may result in moderate or slight personal injury or damage, and may result in only physical loss or damage.







Furthermore, “ CAUTION” level description may lead to a serious risk depend on the circumstances. Be sure to follow the instruction because whichever contains important safety description.

There are the text includes notes using a only safety symbol “”. These also contains important safety instructions, so be sure to follow the instructions.

1.3 Description of Safety Symbols

This document contains annotations with graphic symbols. Be sure to pay close attention to the contents and be sure to follow them.

Symbol meaning

	<p>Indicates a danger, warning or caution notice for fire, electric shock and high temperature in the operation of the product. Details are indicated in or near  by pictures or words.</p>
	<p>The drawing on the left indicates “a non-specific and general danger or caution”.</p>
	<p>The drawing on the left indicates “a possible damage due to electric shock”.</p>
	<p>Indicates “what you must not do” to prohibit the described acts in the operation of the product.</p>
	<p>Indicates “what you must do” according to the instructions in the operation of the product.</p>

1.4 Cautions

1.4.1 Caution!



 **CAUTION**

- Incorrect handling may result in personal death or severe injury, or may result in damage to the inverter, motor or the whole system.

 **Do**

- Be sure to read the Guide and appended documents thoroughly before installing, wiring, operating, maintaining, inspecting or using the inverter.

 **Caution**

- Notes for possible causes of danger or damage are also provided for each explanation in other sections.

 **Do**

- Be sure to read the corresponding explanation thoroughly before installing, wiring, operating, maintaining, inspecting or using the inverter.

 **Caution**

- Many of the drawings in the Guide show the inverter with covers and/or parts blocking your view removed to illustrate the details of the product.

 **Do**

- Do not operate the inverter in the status shown in those drawings. If you have removed the covers and/or parts, be sure to reinstall them in their original positions before starting operation, and follow all instructions in this guide when operating the inverter.

1.4.2 Precautions for installation



 **Fire Hazard**

 **Prohibited**

- Do not place flammable materials near the installed inverter.
- Prevent foreign matter (e.g., cut pieces of wire, sputtering welding materials, iron chips, wire, and dust) from entering the inverter.

 **Do**

- Install the inverter on a non-flammable surface, e.g., metal.
- Install the inverter in a well-ventilated indoor site not exposed to direct sunlight. Avoid places where the inverter is exposed to high temperature, high humidity, condensation, dust, explosive gases, corrosive gases, flammable gases, grinding fluid mist, hydrogen sulfide or salt water.

 **Injury**

 **Prohibited**

- Do not install and operate the inverter if it is damaged or parts are missing.

 **Fall Injury**

 **Prohibited**

 **Do**

- Risk of injury due to the inverter falling!
- When carrying the inverter, do not hold its cover parts.
- Install the inverter on a structure able to bear the weight specified in the User's Guide.
- Install the inverter on a vertical wall that is free of vibrations.

 **Failure**

 **Prohibited**

 **Do**

- Risk of failure of the inverter!
- The inverter is precision equipment. Do not allow it to fall or be subject to high impacts.
- Also do not step on it, or place a heavy load on it.
- Avoid places where static electricity discharges often occur (for example, on a rug) for the operation of the product.
- In order to discharge static electricity from your body, touch a safe metal surface first before starting the operation.

1.4.3 Precautions for Wiring

DANGER

- **Risk of an electric shock and/or fire!**



- Be sure to ground the inverter.
- Entrust wiring work to a qualified electrician.
- Before the wiring work make sure to turn off the power supply and wait for more than 10 or 15 minutes depending on the inverter model(*1) (Confirm that the charge lamp is OFF and the voltage between terminals P and N is 45 VDC or less.)



- **Risk of an electric shock and/or injury!**



- Perform the wiring only after installing the inverter.



- **Risk of failure of the inverter!**



- Do not pull the wire after wiring.



- **Risk of short circuit and ground fault!**



- Do not remove rubber bushings from the wiring section. Otherwise, the edges of the wiring cover may damage the wire.

Warning

- **Risk of injury or fire!**



- Do not connect AC power supply to any of the output terminals (U, V, and W).



- Make sure that the voltage and frequency of AC power supply match the rated voltage (AC input voltage) and frequency of your inverter.



- **Risk of fire!**



- Do not use a single-phase input.
- Do not connect a resistor directly to any of the DC terminals (PD, P, and N).
- Do not use the magnetic contactor installed on the primary and secondary sides of the inverter to stop its operation.



- Tighten the screws and bolts with the specified torque.
- No screws and bolts must be left loose.
- Connect an earth-leakage breaker to the power input circuit.
- Use only the power cables, earth-leakage breaker, and magnetic contactors that have the specified capacity (ratings).



- **Risk of electric shock and injury!**



- Before operating the slide switch (SW*) in the inverter, be sure to turn off the power supply.
- Since the inverter supports two modes of cooling-fan operation, the inverter power is not always off, even when the cooling fan is stopped. Before operating the switch, be sure to turn off the power supply and wait for more than 10 or 15 minutes depending on the inverter model(*1) (Confirm that the Charge lamp on the inverter is off and the DC voltage between terminals P and N is 45 V or less.)
- Prevent the distribution cable from being compressed or getting caught to avoid damage to the cable.



- **Risk of damage to the inverter and burnout of the motor!**





- Do not operate the inverter when an output phase is lost (output phase loss).

*1) For P1-00044-L to P1-01240-L (P1-004L to P1-220L), P1-00041-H to P1-00620-H (P1-007H to P1-220H) models the wait time is 10 minutes. For P1-01530-L to P1-02950-L (P1-300L to P1-550L), P1-00770-H to P1-06600-H (P1-300H to P1-3150H) models the wait time is 15 minutes.

1.4.4 Precautions for Running and Test Running



DANGER

**Electric shock
Fire**



Prohibited

- **Risk of electric shock or fire!**
 - While power is supplied to the inverter, do not touch any internal part or the terminal of the inverter. Also do not check signals, or connect or disconnect any wire or connector.
 - While power is supplied to the inverter, do not touch any internal part of the inverter. Also do not insert a bar in it.

Electric shock



Prohibited

- **Risk of electric shock!**
 - Be sure to close the terminal block cover before turning on the inverter power. Do not open the terminal block cover while power is being supplied to the inverter or voltage remains inside. Do not touch the internal PCB, terminal block or connector while power is being supplied to the inverter or voltage remains inside.
 - Do not operate switches in the inverter or on the board with wet hands.

**Injury
Fire**



Prohibited

- **Risk of injury or fire!**
 - While power is supplied to the inverter, do not touch the terminal of the inverter, even if it has stopped.



**Injury
Damage**

Prohibited

- **Risk of injury and damage to machine!**
 - Do not select the retry mode for controlling an elevating or traveling device because free-running status occurs in retry mode.
 - If you use the EzSQ program, before operating the inverter, verify that secure operation of the program is ensured.



Injury



Prohibited

Do

- **Risk of injury!**
 - If the retry mode has been selected, the inverter will restart suddenly after a break upon detection of an error. Stay away from the machine controlled by the inverter when the inverter is under such circumstances. (Design the machine so that human safety can be ensured, even when the inverter restarts suddenly.)
 - The [STOP] key on the operator keypad VOP can be enabled/disabled using the STOP-key enable [AA-13] and It is effective only when there is no connection abnormality between the keypad and the main unit. Prepare an emergency stop switch separately.
 - If an operation command has been input to the inverter before a short-term power failure, the inverter may restart operation after the power recovery. If such a restart may put persons in danger, design a system configuration that disables the inverter from restarting after power recovery.
 - If an operation command has been input to the inverter before the inverter enters alarm status, the inverter will restart suddenly when the alarm status is reset (by terminal, key operation or communication). Before resetting the alarm status, make sure that no operation command has been input.
 - When an unexpected event occurs, do not touch the inverter or cable.
 - Make sure to understand and check the functions the inverter provides to confirm safety. Be careful that operation commands or resetting operation do not cause an unexpected restart.
 - When an error (alarm) occurs, before moving to the next operation (resetting the alarm status or reapplying the power), make sure that no operation command has been input. If the inverter has received an operation command, it restarts automatically.



Warning

**Injury
Damage**



Do

- **Risk of injury and damage to machine!**
 - The inverter allows you to easily control the speed of the motor or machine operations. Before operating the inverter, confirm the capacity and ratings of the motor or machine controlled by the inverter.
 - When using the inverter to operate a motor at a high frequency, check the allowable motor speeds with the manufacturers of the motor and the machine to be driven and obtain their consent before starting inverter operation.
 - During inverter operation, check the motor for the direction of rotation, abnormal sound, and vibrations.

**Burn
injury**

Prohibited

- **Risk of burn injury!**
 - Do not touch the heat sink, which heats up during the inverter operation.

Injury

Do

- **Risk of injury!**
 - Install an external brake system if needed.

1.4.5 Precautions for Maintenance/Daily Inspection



Electric shock

Do

- **Risk of electric shock!**
- Before inspecting the inverter, be sure to turn off the power supply and more than 10 or 15 minutes depending on the inverter model(*1). (Confirm that the Charge lamp on the inverter is off and the DC voltage between terminals P and N is 45 V or less.)

Prohibited

- Entrust only a designated person for maintenance, inspection, and the replacement of parts. (Be sure to remove wristwatches and metal accessories, e.g., bracelets, before maintenance and inspection work and to use insulated tools for the work.)

*1) For P1-00044-L to P1-01240-L (P1-004L to P1-220L), P1-00041-H to P1-00620-H (P1-007H to P1-220H) models the wait time is 10 minutes. For P1-01530-L to P1-02950-L (P1-300L to P1-550L), P1-00770-H to P1-06600-H (P1-300H to P1-3150H) models the wait time is 15 minutes.

1.4.6 Precautions for disposal



Injury Explosion

Do

- **Risk of injury and explosion!**
- For disposal of the inverter, outsource to a qualified industrial waste disposal contractor. Disposing of the inverter on your own may result in an explosion of the capacitor or produce poisonous gas.
- Contact your supplier or local Hitachi salse office for fixing the inverter.

Do

- A qualified industrial waste disposal contractor includes industrial waste collector/ transporter and industrial waste disposal operator.
- Follow the laws and regulations of each country for disposing of the inverter.

1.4.7 Other Cautions



Electric shock Fire Injury

Prohibited

- **Risk of electric shock, fire and injury!**
- Never modify the inverter.

Life cycle

Do

- **Risk of significantly shortening the life cycle of a product!**
- If wood materials for packaging are needed to be sterilized and disinfected, make sure to use a means other than the wood fumigation method. If the product is included in the fumigation treatment, electronic parts could receive critical damage from the emitted gases or vapors. Especially, halogen disinfectants (including fluorine, chlorine, bromine and iodine) can cause corrosion in the capacitor.

* For risks other than the above, also refer to "Chapter 8 Operation Check/Residual Risks".

1.5 Examples of Caution Labels

- The following describes label formats to prevent errors from occurring in the motor, inverter and system.
- If external operation, program operation or retry function has been set, the operation may start automatically after the power is off. Use these labels referring to the examples on the right as a reminder for caution.

(Examples of labels)

- Write instructions on these labels as a reminder.

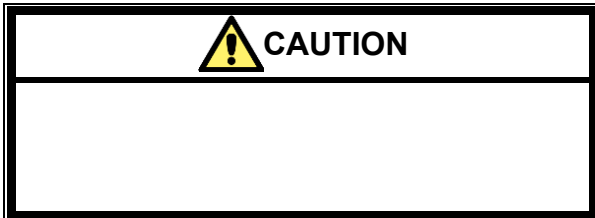

(Examples of labels)

- Reminder for caution for retry operation after an error

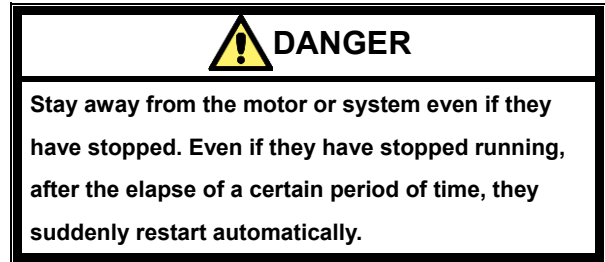

(Examples of labels)

- Reminder for caution for remote operation in communication and terminal contact operation after the power is on.

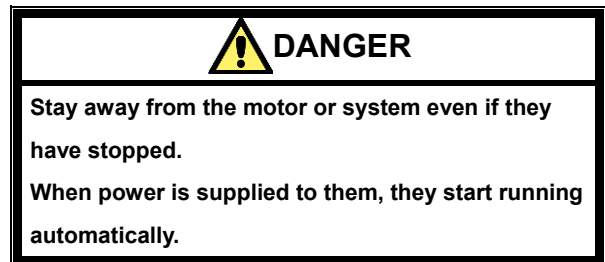

1.6 Compliance with European Directive (CE)

1.6.1 CAUTION for EMC (Electromagnetic Compatibility)

The SJ series P1 inverter conforms to requirements of the Electromagnetic Compatibility (EMC) Directive (2014/30/EU). However, when using the inverter in Europe, you must comply with the following specifications and requirements to meet the EMC Directive and other standards in Europe:



WARNING: This equipment must be installed, adjusted, and maintained by qualified engineers who have expert knowledge of electric work, inverter operation, and the hazardous circumstances that can occur. Otherwise, personal injury may result.

1. Power supply requirements
 - a. Voltage fluctuation must be -15% to +10% or less.
 - b. Voltage imbalance must be $\pm 3\%$ or less.
 - c. Frequency variation must be $\pm 4\%$ or less.
 - d. Total harmonic distortion (THD) of voltage must be $\pm 10\%$ or less.
2. Installation requirement
 - a. SJ series P1 includes a built-in EMC filter. The built-in EMC filter must be activated.
 - b. According to EN61800-3 it is mandatory to mention that any inverter with only C3 filter inside may NOT be connected to a low voltage public power supply in residential areas since for these installations C1 is required.
 - c. In case of external filter for C2, an additional note is required according to EN61800-3 that "this product may emit high frequency interference in residential areas which may require additional EMC measures".
 - d. According to the EN6100-3-12, an additional AC reactor or DC choke should be installed for reducing harmonics in power line.
3. Wiring requirements
 - a. A shielded wire (screened cable) must be used for motor wiring, and the length of the cable must be according to the following table (Table 1 on page 1-9).
 - b. The carrier frequency must be set according to the following table to meet an EMC requirement (Table 1 on page 1-9).
 - c. The main circuit wiring must be separated from the control circuit wiring.
4. Environmental requirements
(to be met when a filter is used)
 - a. SJ series P1 inverter that is an activated built-in EMC filter must be according to SJ series P1 specifications.

Table 1

Model	Cat.	Cable Length (m)	Carrier Frequency (kHz)	Model	Cat.	Cable Length (m)	Carrier Frequency (kHz)
P1-00044-L (P1-004L)	C3	3m	2kHz	-	-	-	-
P1-00080-L (P1-007L)	C3	3m	2kHz	P1-00041-H (P1-007H)	C3	3m	2kHz
P1-00104-L (P1-015L)	C3	3m	2kHz	P1-00054-H (P1-015H)	C3	3m	2kHz
P1-00156-L (P1-022L)	C3	3m	2kHz	P1-00083-H (P1-022H)	C3	3m	2kHz
P1-00228-L (P1-037L)	C3	3m	2kHz	P1-00126-H (P1-037H)	C3	3m	2kHz
P1-00330-L (P1-055L)	C3	5m	2kHz	P1-00175-H (P1-055H)	C3	5m	2kHz
P1-00460-L (P1-075L)	C3	5m	2kHz	P1-00250-H (P1-075H)	C3	5m	2kHz
P1-00600-L (P1-110L)	C3	5m	2kHz	P1-00310-H (P1-110H)	C3	5m	2kHz
P1-00800-L (P1-150L)	C3	10m	1kHz	P1-00400-H (P1-150H)	C3	10m	2kHz
P1-00930-L (P1-185L)	C3	10m	1kHz	P1-00470-H (P1-185H)	C3	10m	2kHz
P1-01240-L (P1-220L)	C3	10m	1kHz	P1-00620-H (P1-220H)	C3	10m	2kHz
P1-01530-L (P1-300L)	C3	5m	2kHz	P1-00770-H (P1-300H)	C3	5m	2kHz
P1-01850-L (P1-370L)	C3	5m	2kHz	P1-00930-H (P1-370H)	C3	5m	2kHz
P1-02290-L (P1-450L)	C3	5m	2kHz	P1-01160-H (P1-450H)	C3	5m	2kHz
P1-02950-L (P1-550L)	C3	5m	2kHz	P1-01470-H (P1-550H)	C3	5m	2kHz
-	-	-	-	P1-01760-H (P1-750H)	C3	3m	2kHz
-	-	-	-	P1-02130-H (P1-900H)	C3	3m	2kHz
-	-	-	-	P1-02520-H (P1-1100H)	C3	3m	2kHz
-	-	-	-	P1-03160-H (P1-1320H)	C3	3m	2kHz
-	-	-	-	P1-03720-H (P1-1600H)	C3	3m	2kHz
-	-	-	-	P1-04320-H (P1-1850H)	C3	3m	2kHz
-	-	-	-	P1-04860-H (P1-2000H)	C3	3m	2kHz
-	-	-	-	P1-05200-H (P1-2200H)	C3	3m	2kHz
-	-	-	-	P1-05500-H (P1-2500H)	C3	3m	2kHz
-	-	-	-	P1-06600-H (P1-3150H)	C3	3m	2kHz

1.6.2 Caution for Machinery Directive (Functional Safety)

SJ Series P1 conforms to STO (Safe Torque Off) defined in Functional Safety IEC 61800-5-2. When using the STO function refer to "SJ-P1 Safety Function Guide Supplement"(NTZ2512*X) on the separate sheet. And further download "Safety function Guide (NT2512*X)" from our website below and carefully read it.

<https://www.hitachi-ies.co.jp/english/products/inv/sjp1/>



When using STO (Safe Torque Off) function please be sure to read the "Safety functional Guide" of separate!

Applicable models for functional safety are P1-00044-L (P1-004L) to P1-02950-H (P1-550L) / P1-00041-H (P1-007H) to P1-03160-H (P1-1320H). For details, refer to "Appendix EC Declaration of Conformity (Copy)" on page A-1 of "Safety function Guide (NT2512*X)".

1.7 Compliance with UL Standards

UL CAUTION

GENERAL:

The SJ series Type P1 inverter is an open type AC Inverter with three phase input and three phase output. It is intended to be used in an enclosure. It is used to provide both an adjustable voltage and adjustable frequency to the AC motor. The inverter automatically maintains the required Volts-Hz ratio allowing the capability through the motor speed range. It is a multi-rated device and the ratings are selectable according to load types by operator with key pad operation.

Markings:

Maximum Surrounding Temperature:

- ND (Normal Duty) : 50degC
- LD (Low Duty) : 45degC
- VLD (Very Low Duty): 40degC

Storage Environment rating:

- 65degC (for transportation)

Instruction for installation:

- pollution degree 2 environment and Overvoltage category III

Electrical Connections:

- See section [7.5 Connect Wire to the Main Circuit Terminal Block].

Interconnection and wiring diagrams:

- See section [7.7 Control Circuit Terminal Area].

Short circuit rating and overcurrent protection device rating:

P1-L series, P1-00044-L to P1-01240-L models

- Suitable for use on a circuit capable of delivering not more than 5,000 rms symmetrical amperes, 240 V maximum".

P1-L series, P1-01530-L to P1-02950-L models

- Suitable for use on a circuit capable of delivering not more than 10,000 rms symmetrical amperes, 240 V maximum".

P1-H series, P1-00041-H to P1-00620-H models

- Suitable for use on a circuit capable of delivering not more than 5,000 rms symmetrical amperes, 500 V maximum".

P1-H series, P1-00770-H to P1-02130-H models

- Suitable for use on a circuit capable of delivering not more than 10,000 rms symmetrical amperes, 500 V maximum".

P1-H series, P1-02520-H to P1-04320-H models

- Suitable for use on a circuit capable of delivering not more than 18,000 rms symmetrical amperes, 500 V maximum".

P1-H series, P1-04860-H to P1-05500-H models

- Suitable for use on a circuit capable of delivering not more than 30,000 rms symmetrical amperes, 500 V maximum".

P1-H series, P1-06600-H model

- Suitable for use on a circuit capable of delivering not more than 42,000 rms symmetrical amperes, 500 V maximum".

Integral:

- Integral solid state short circuit protection does not provide branch circuit protection. Branch circuit protection must be provided in accordance with the National Electrical Code and any additional local codes.

Field wiring terminal conductor size and Torque Values making for field wiring terminal:

• 200V Class

Model	Load Type	Required Torque (N·m)	Conductor size (AWG)
P1-00044-L (P1-004L)	VLD	1.4	14
	LD		
	ND		
P1-00080-L (P1-007L)	VLD	1.4	14
	LD		
	ND		
P1-00104-L (P1-015L)	VLD	1.4	14
	LD		
	ND		
P1-00156-L (P1-022L)	VLD	1.4	10
	LD		14
	ND		
P1-00228-L (P1-037L)	VLD	1.4	10
	LD		
	ND		
P1-00330-L (P1-055L)	VLD	3	8
	LD		
	ND		
P1-00460-L (P1-075L)	VLD	3	6
	LD		8
	ND		
P1-00600-L (P1-110L)	VLD	4	4
	LD		6
	ND		
P1-00800-L (P1-150L)	VLD	2.5 to 3.0	3
	LD		4
	ND		
P1-00930-L (P1-185L)	VLD	2.5 to 3.0	1
	LD		2
	ND		
P1-01240-L (P1-220L)	VLD	5.5 to 6.6	2/0
	LD		1/0
	ND		
P1-01530-L (P1-300L)	VLD	6.0	Parallel of 1/0
	LD		Parallel of 1/0
	ND		
P1-01850-L (P1-370L)	VLD	6.0 to 10.0	Parallel of 1/0
	LD	15.0	Parallel of 1/0
	ND		4/0
P1-02290-L (P1-450L)	VLD	6.0 to 10.0	Parallel of 2/0
	LD		Parallel of 1/0
	ND		
P1-02950-L (P1-550L)	VLD	10.0 to 12.0	Parallel of 3/0
	LD		Parallel of 3/0
	ND		

- The temperature rating of field wiring installed conductors is only 75degC.
- Use Copper conductors only.

• 400V Class

Model	Load Type	Required Torque (N·m)	Conductor size (AWG)
P1-00041-H (P1-007H)	VLD/LD/ND	1.4	14
P1-00054-H (P1-015H)	VLD/LD/ND	1.4	14
P1-00083-H (P1-022H)	VLD/LD/ND	1.4	14
P1-00126-H (P1-037H)	VLD	1.4	12
	LD		14
	ND		
P1-00175-H (P1-055H)	VLD	3	10
	LD		12
	ND		
P1-00250-H (P1-075H)	VLD	3	8
	LD		10
	ND		
P1-00310-H (P1-110H)	VLD/LD/ND	4	8
P1-00400-H (P1-150H)	VLD/LD/ND	4	8
P1-00470-H (P1-185H)	VLD	4	6
	LD		8
	ND		
P1-00620-H (P1-220H)	VLD	4	4
	LD		6
	ND		
P1-00770-H (P1-300H)	VLD	2.5 to 3.0	1
	LD		2
	ND		
P1-00930-H (P1-370H)	VLD/LD/ND	15.0	1
P1-01160-H (P1-450H)	VLD	15.0	1/0
	LD		1
	ND		
P1-01470-H (P1-550H)	VLD	6.0 to 10.0	Parallel of 1/0
	LD	15.0	2/0
	ND		1/0
P1-01760-H (P1-750H)	VLD/LD/ND	10.0 to 12.0	Parallel of 1/0
P1-02130-H (P1-900H)	VLD	10.0 to 12.0	Parallel of 2/0
	LD		Parallel of 1/0
	ND		
P1-02520-H (P1-1100H)	VLD	10.0 to 12.0	Parallel of 3/0
	LD		Parallel of 2/0
	ND		
P1-03160-H (P1-1320H)	VLD	10.0 to 12.0	P. of 250kcmil
	LD		Parallel of 4/0
	ND		
P1-03720-H (P1-1600H)	VLD	15.5 to 18.5	P. of 250kcmil
	LD		Parallel of 4/0
	ND		
P1-04320-H (P1-1850H)	VLD	15.5 to 18.5	P. of 300kcmil
	LD		P. of 250kcmil
	ND		
P1-04860-H (P1-2000H)	VLD	37.0	P. of 350kcmil
	LD		P. of 300kcmil
	ND		
P1-05200-H (P1-2200H)	VLD	37.0	P. of 400kcmil
	LD		P. of 350kcmil
	ND		
P1-05500-H (P1-2500H)	LD	37.0	P. of 500kcmil
	ND		P. of 400kcmil
P1-06600-H (P1-3150H)	LD/ND	37.0	P. of 600kcmil

Required protection by Fuse and circuit-breakers:
P1-L series models

Model	Fuse			Circuit Breaker	
	Type	Maximum Rating		Maximum Rating	
		Voltage (V)	Current (A)	Voltage (V)	Current (A)
P1-00044-L (P1-004L)	Class J or T	600	15	-	-
P1-00080-L (P1-007L)	Class J or T	600	30	-	-
P1-00104-L (P1-015L)	Class J or T	600	40	-	-
P1-00156-L (P1-022L)	Class J or T	600	40	-	-
P1-00228-L (P1-037L)	Class J or T	600	50	-	-
P1-00330-L (P1-055L)	Class J or T	600	100	-	-
P1-00460-L (P1-075L)	Class J or T	600	150	-	-
P1-00600-L (P1-110L)	Class J or T	600	150	-	-
P1-00800-L (P1-150L)	Class J or T	600	150	-	-
P1-00930-L (P1-185L)	Class J or T	600	200	-	-
P1-01240-L (P1-220L)	Class J or T	600	200	-	-
P1-01530-L (P1-300L)	Class J or T	600	300	-	-
P1-01850-L (P1-370L)	Class J or T	600	300	-	-
P1-02290-L (P1-450L)	Class J or T	600	400	-	-
P1-02950-L (P1-550L)	Class J or T	600	500	-	-

P1-H series models

Model	Fuse			Circuit Breaker	
	Type	Maximum Rating		Maximum Rating	
		Voltage (V)	Current (A)	Voltage (V)	Current (A)
P1-00041-H (P1-007H)	Class J or T	600	15	-	-
P1-00054-H (P1-015H)	Class J or T	600	20	-	-
P1-00083-H (P1-022H)	Class J or T	600	30	-	-
P1-00126-H (P1-037H)	Class J or T	600	30	-	-
P1-00175-H (P1-055H)	Class J or T	600	75	-	-
P1-00250-H (P1-075H)	Class J or T	600	75	-	-
P1-00310-H (P1-110H)	Class J or T	600	75	-	-
P1-00400-H (P1-150H)	Class J or T	600	100	-	-
P1-00470-H (P1-185H)	Class J or T	600	100	-	-
P1-00620-H (P1-220H)	Class J or T	600	100	-	-
P1-00770-H (P1-300H)	Class J or T	600	200	-	-
P1-00930-H (P1-370H)	Class J or T	600	200	-	-
P1-01160-H (P1-450H)	Class J or T	600	200	-	-
P1-01470-H (P1-550H)	Class J or T	600	250	-	-
P1-01760-H (P1-750H)	Class J or T	600	300	-	-
P1-02130-H (P1-900H)	Class J or T	600	400	-	-
P1-02520-H (P1-1100H)	Class J or T	600	500	-	-
P1-03160-H (P1-1320H)	Class J or T	600	500	-	-
P1-03720-H (P1-1600H)	Class L	600	1000	-	-
P1-04320-H (P1-1850H)	Class L	600	1000	-	-
P1-04860-H (P1-2000H)	Class L	600	1000	-	-
P1-05200-H (P1-2200H)	Class L	600	1000	-	-
P1-05500-H (P1-2500H)	Class L	600	1000	-	-
P1-06600-H (P1-3150H)	Class L	600	1600	-	-

(memo)

2

Chapter 2 Handling of This User's Guide

Contents

2.1 What This Chapter Explains	2-1
2.2 Applicable Products	2-1
2.3 Before Reading the Guide	2-1
2.4 Purpose of the Guide	2-1
2.5 Overview of the Guide	2-2
2.6 Glossary	2-3
2.7. Operating Principles	2-5
2.7.1 Purpose of Industrial Motor Control	2-5
2.7.2 What Is an Inverter?	2-5
2.8 Meanings of the Explanatory Symbols	2-6

2.1 What This Chapter Explains

This chapter includes explanations of applicable products, knowledge required for reading the Guide, those who should read the Guide, and the purpose, overview and glossary of the Guide.

2.2 Applicable Products

The contents of this guide are applicable to the SJ series inverter type P1. Refer to the corresponding instruction manuals for other products and optional parts.

2.3 Before Reading the Guide

The Guide is meant to be read by those who have knowledge of electricity (certified electrician or equivalent) and those who are in charge of introduction, installation or connection of control equipment, system design and workplace management.

The Guide is written in SI units.

2.4 Purpose of the Guide

The Guide is meant to provide necessary information for the following:

- Installation and wiring of the product;
- Parameter settings;
- Running and test running; and
- Maintenance and inspection

2.5 Overview of the Guide

The Guide consists of the following chapters:

- **Safety Instructions/Risks (Chapter 1)** includes safety instructions for installation, wiring, operation, maintenance and inspection the inverter.
- **Handling of This User's Guide (Chapter 2)** includes explanations of those who should read the Guide and purpose of the Guide.
- **You Can Run the Inverter after Reading This Chapter (Chapter 3)** explains the overall process flow from installation to operation and provides a flow chart for driving motors.
- **Main Body of the Product (Chapter 4)** explains description on specification label on the main body and product's model and overview.
- **Included Items (Chapter 5)** explains items included in a product package.
- **Installation (Chapter 6)** provides notes for installation and installation environment of the inverter.
- **Wire Connection and Optional Devices (Chapter 7)** explains how to wire the inverter and connect separately-placed optional devices. See Chapter 15 for the optional cassette for installing inside the inverter.
- **Operation Check/Residual risks (Chapter 8)** provides an operation checklist for installation of the inverter.
- **Operating (Chapter 9)** explains how to operate the operator keypad equipped on the main body.
- **Test Run (Chapter 10)** provides a flowchart to check for rotating the motor and operations required for test runs.
- **Frequency References and RUN Commands Examples (Chapter 11)** explains how to connect I/O by input of operation commands and frequency commands.
- **Inverter Functions (Chapter 12)** explains functions available with the inverter.
- **Information Monitor Functions (Chapter 13)** explains functions monitorable with the operator keypad.
- **RS485 Communication (Chapter 14)** explains communication functions using RS485 communication.
- **Optional Cassettes (Chapter 15)** includes explanations of optional cassettes installable in the SJ series inverter type P1.
- **ProDriveNext / EzSQ (Chapter 16)** explains the availability of the SJ series inverter type P1 with PC connected.
- **Connection with PLC (Chapter 17)** explains how to connect to PLC.
- **Tips/FAQ/Troubleshooting (Chapter 18)** includes explanations of the error (trip) status of the inverter and provides troubleshooting information.
- **Maintenance and Inspection (Chapter 19)** explains how to maintain and inspect the inverter.
- **Specifications (Chapter 20)** provides the specifications of the product.
- **Technical Notes (Chapter 21)** provides supplemental technical information.
- **List of Parameters and Index (Appendix)** provides explanations of the parameters for the SJ series inverter type P1. An index is provided at the end of the Guide.

2.6 Glossary

B

Name	Description
Basic Guide	Basic instruction manual including only information required for handling the inverter.
Braking resistor	A resistor for consuming regenerative power by connecting to the regenerative brake unit or built-in brake circuit model.

C

Name	Description
CE marking	A mark used on the product that meets the requirements of the applicable EC directives. This is required for products sold within the European Economic Area.
Charge lamp	Indicates the status of power input to the main circuit of the inverter. Power remains when the lamp is lit even after the power is off.

E

Name	Description
EMC	Electromagnetic compatibility. Properties that neither cause errors in other equipment nor cause errors due to noise.

H

Name	Description
Harmonics (noise)	A sinusoidal distorted wave current with a frequency that is an integral multiple of the commercial power supply sine wave generated from the inverter.
high frequency noise	Noise generated by voltage switching during power conversion by an inverter. There are conductive noise that travels in electric wires, radiation noise that travels in the air, and induction noise that is induced in adjacent electric wires.

I

Name	Description
I/O	Input / Output.
IGBT	Insulated Gate Bipolar Transistor. One of switching devices of the inverter.
IM	Induction motor.
Intelligent output terminal	Multi-functional contact output terminal. Multiple functions are available according to settings.
Intelligent input terminal	Multi-functional contact input terminal. Multiple functions are available according to settings.
Inverter model	The model indicated on the specification label of the inverter.

L

Name	Description
LAD	Lead to acceleration and deceleration. Accelerate or decelerate the motor.
LD rated	Low duty: A type of load rating that indicates overload capacity. This can drive a higher current motor than ND but has a relatively lower overload capacity. This can be used for low load capacity.

*Note concerning trademarks

Proper names such as the product name and function names mentioned in the Guide may be used by each company as its trademark or registered trademark. In this guide, no ® and ™ symbols are used.

M

Name	Description
Main circuit power supply	Power supply required for running the inverter. Normally, power supply for control circuit is also required for running the inverter.
MFG No.	Manufacturing No.

N

Name	Description
ND rated	Normal Duty: A type of load rating that indicates rated current and overload capacity. Generally this is used in severe load conditions.

O

Name	Description
Open phase	A part of the power line is down, leading to unstable input/output.
Operator keypad	A control panel on the front side to operate the inverter.
Optional cassette	A cassette-type optional part to be loaded in the slot on the front side of the product.

P

Name	Description
PLC	Programmable logic controller.
Potentiometer	A regulating device with a variable resistor. Connect to the analog input terminal.
Power supply for control circuit	Power supply required for control circuits such as the parameter R/W by the operator keypad VOP, PWM control circuit and etc., which supplies power to R0/T0 terminals.
PMM	Abbreviation for Permanent Magnet synchronous Motor.
PWM	Pulse Width Modulation. Pulse output method of the inverter.

R

Name	Description
Regenerating	Returning of power generated in the motor to the inverter when fans are rotated by wind or the motor speed is decreased.
Regenerative converter	An optional equipment to return regenerated power to the power supply. This significantly reduce harmonic current of power supply.
Regenerative braking unit	A separate unit that allows regenerative power to be consumed by the braking resistor. (There are models that braking circuit is built-in or non-built-in. Select an appropriate braking resistor and connect it.)
RTU	Remote terminal unit. The Modbus protocol name here.

S

Name	Description
Sink logic	This means a difference in common. With the sink type logic, when using an input unit such as a PLC, when the input terminal is ON, current flows from the inverter input terminal side to the input unit side.
SM	Synchronous motor. PMM is a type of SM.
Source logic	This means a difference in common. With the source type logic, when using an input unit such as a PLC, for example, when the input terminal is ON, current flows from the input unit side to the inverter input terminal side.
Specification label	A label on the side the product, on which the specifications of the inverter are indicated.

U

Name	Description
UL standards	Standards issued by Underwriters Laboratories (Board of Fire Underwriters).
User's Guide	Instruction manual including detailed information required for handling the inverter.

V

Name	Description
VLD rated	Very low duty: A type of load rating that indicates rated current and overload capacity. This can drive a higher current motor than LD but has a relatively lower overload capacity. This can be used for lower load capacity than LD.
VOP	The standard operator keypad of SJ-P1 has a color LCD panel, and VOP is an abbreviation for V iewable O perator P anel. In the text, it is written as "operator keypad VOP".

2.7. Operating Principles

A

- This section describes operating principles briefly.

2.7.1 Purpose of Industrial Motor Control

- A Hitachi inverter can vary three phase motor speed. Varying speed can provide advantages in many applications. For example, it is useful for the purposes on the right.

- Energy savings
Ex.) HVAC (air-conditioner); fans; pumps

- Adjacent processes requiring speed adjustment
Ex.) textile machines; printing machines

- Load requiring torque
Ex.) machine tools; processing machines; transportation equipment

- Load requiring fine control
Ex.) elevators; food processing;

2.7.2 What Is an Inverter?



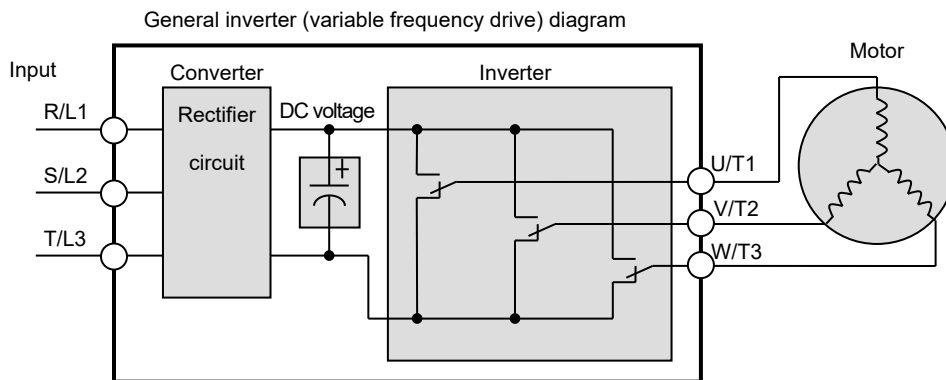

- An inverter can control the rotation speed and power consumption of motors by changing the frequency and voltage input to motors.
- Motors waste energy running fans and pumps using a commercial power supply and controlling the flow rate using valves and dampers. An inverter can lower the commercial power supply frequency and voltage, which contributes to energy savings by powering down without valves and dampers.
- An inverter is a device that converts direct current into alternating current. The diagram below illustrates the basic configuration of a general inverter.
- First the converter part converts alternating current supplied from the power supply into direct current through the rectifier circuit.
- The inverter part outputs frequency and voltage flexibly by outputting the direct current "chopped" by switching devices to the motor (PWM output).
- The volume of the sound and noise generated by the motor varies depending on the rate of chopping DC voltage of switching devices (carrier frequency) in the inverter part.



2.8 Meanings of the Explanatory Symbols

The following symbols are used for description in each section.

The meanings of the symbols are as follows.

Symbol and meanings	Description
General and troubleshooting questions 	Provides troubleshooting tips. When a similar problem occurs, using the inverter functions may solve the problem.
Key points for a solution 	Provides tips for settings for using functions and describe the details of functions.
Notes 	Provides notes for operating functions. The notes for operating functions include: Data is overwritten, No operation with no settings etc.
Confirmation of procedures 	Provides procedures for setting and adjusting the functions.

3

Chapter 3 You Can Run the Inverter after Reading This Chapter

Contents

3.1 What This Chapter Explains 3-1
3.2 Flow for Preparation of Operation 3-2
 3.2.1 Check the Inverter..... 3-2
 3.2.2 Install the Inverter..... 3-2
 3.2.3 Wire to the Inverter, and Turn on
 the Power Supply and Check 3-3
 3.2.4 Operations the Keypad VOP..... 3-3
 3.2.4 Preparing to Rotate the Motor..... 3-4
 3.2.5 Troubleshooting..... 3-4

3.1 What This Chapter Explains

This chapter provides an operational process (flow) to do a test run. For installation, wiring and settings for operation and detailed information of inverter functions, see the corresponding sections. Make sure to carefully read “Chapter 1 Safety Instructions/Risks” and corresponding sections for safety work.

3.2 Flow for Preparation of Operation

3.2.1 Check the Inverter

Check the contents in the package, and also check the model of your inverter on the specification label.

See “Chapter 4 Main Body of the Product” and “Chapter 5 Included Items” for details.



Inverter body



Basic Guide

Included items that vary depending on models.
(included in the package)

<p>Enclosed in the P1-01240-L(P1-220L)</p> <p>M3x8 screws : 4 pcs Spacer : 4 pcs</p>	<p>Enclosed in the P1-01850-L(P1-370L)/ P1-00930-H(P1-370H) or above.</p> <p>Eye bolts for hanging the inverter</p>	<p>Enclosed in the P1-03720-H(P1-1600H) to P1-05500-H(P1-2500H). (For P1-06600-H(P1-3150H), included only the bolts for the ground terminal. See chapter 6.2 for details.)</p> <ul style="list-style-type: none"> Supplemental terminal for braking unit connection (the shape differs depending on the model) and bolts for it. 1 pcs , M8x18 bolt : 2 pcs Bolts for the ground terminal M12x20 bolt : 2 pcs
---	---	---

3.2.2 Install the Inverter

Install the inverter. Leave sufficient space around the inverter for enough ventilation.

See “Chapter 6 Installation” for details.

For P1-00044-L to P1-02950-L (P1-004L to P1-550L);
P1-00041-H to P1-01470-H (P1-007H to P1-550H)

For P1-01760-H to P1-06600-H (P1-750H to P1-3150H)

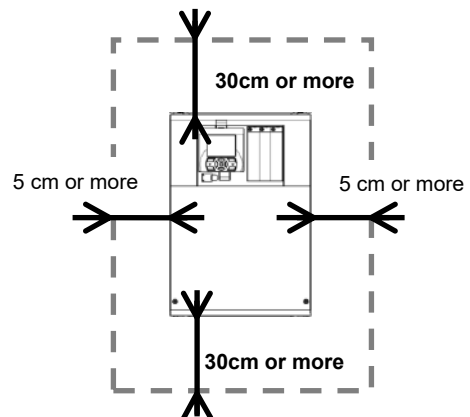
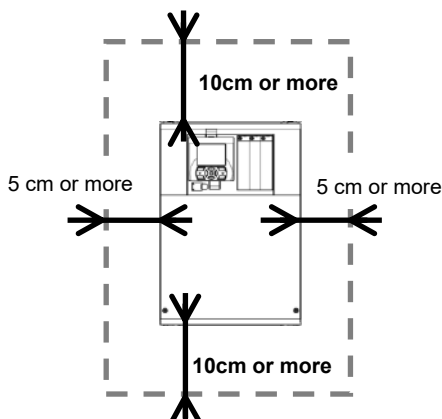

* A clearance of 22 cm or more is required below the inverter to replace aged parts for the following models:

- P1-00800-L(P1-150L) to P1-01240-L(P1-220L)
- P1-00400-H(P1-150H) to P1-00620-H(P1-220H)

* The inverter needs to be removed to replace aged parts for the following models:

- P1-00044-L(P1-004L) to P1-00600-L(P1-110L)
- P1-00041-H(P1-007H) to P1-00310-H(P1-110H)

3.2.3 Wire to the Inverter, and Turn on the Power Supply and Check

- Wire the main circuit of the inverter.
- Before supplying the power, make sure to carefully read the safety instructions and be aware of your safety. The following illustration shows the power supply and wiring connections to a motor only.
- Follow the following steps to prevent miswiring.

- (1) Check the position of the charge lamp and make sure that the lamp is turned off.
- (2) Connect the inverter to the ground (G) and power supply line (R,S,T), and close the terminal block cover.
- (3) Turn on the power and confirm that the POWER LED on the operator keypad VOP is lit.

See “Chapter 1 Safety Instructions”, “Chapter 7 Wire Connection and Optional Devices” and “Chapter 11 Examples of Settings by Operation Command Destination” for details.

*Allocation of terminals varies depending on models.
*This example shows a state with a J51 connector connected.

- (4) Turn off the power.
- (5) Make sure that the charge lamp is off and that the voltage between P and N is 45 VDC or less.
- (6) Connect the inverter to the motor line (U,V,W), and close the terminal block cover.
- (3) Turn on the power to operate the operator keypad.

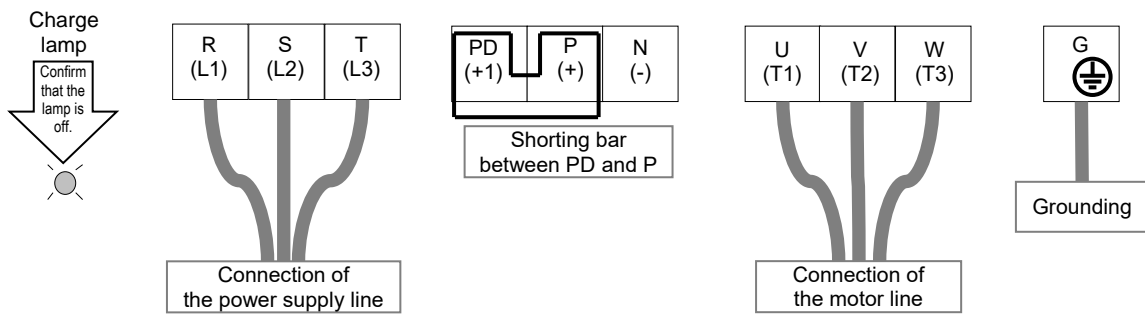

3.2.4 Operations the Keypad VOP

Confirm how to operate the operator keypad.

See “Chapter 9 Operating” for details.

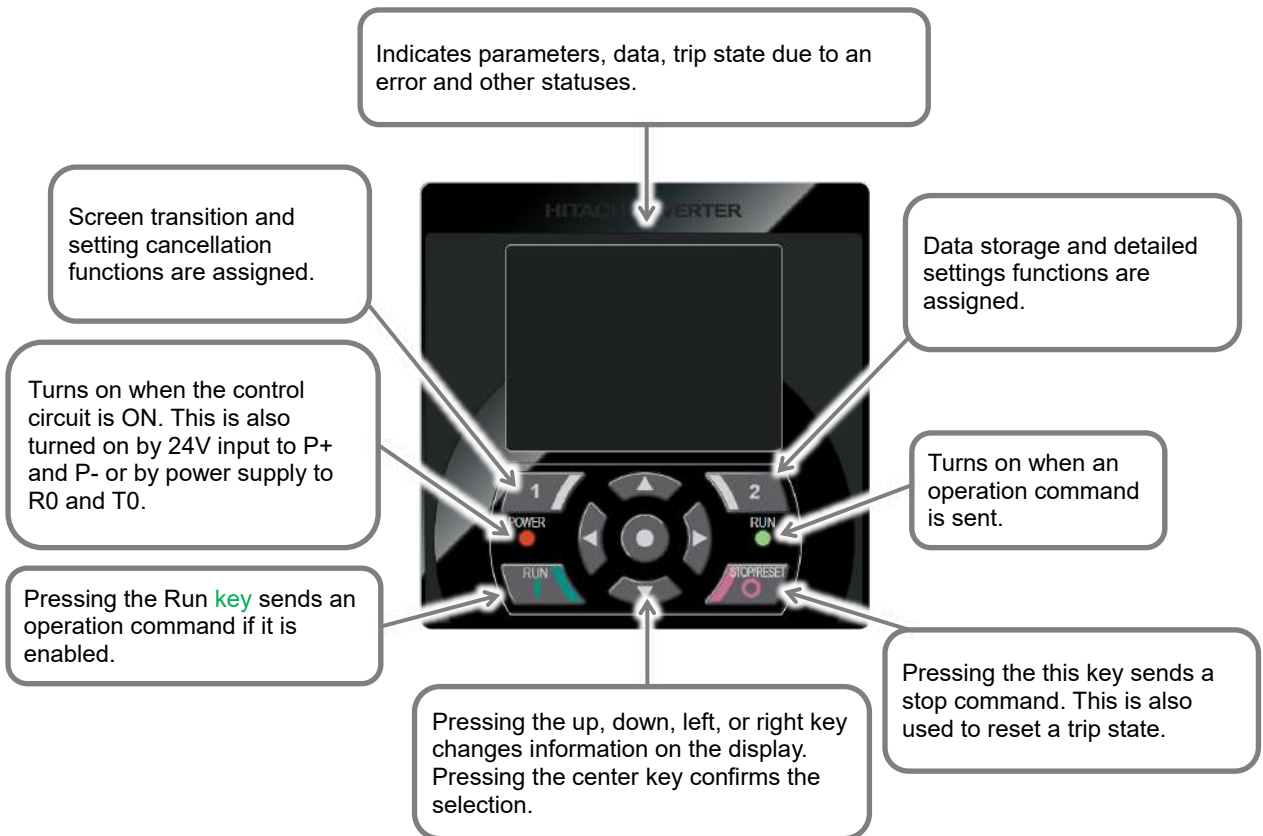

3.2.4 Preparing to Rotate the Motor

Only operating procedures using the operator keypad are shown here.

Refer to “Chapter 10 Test Run” for details.

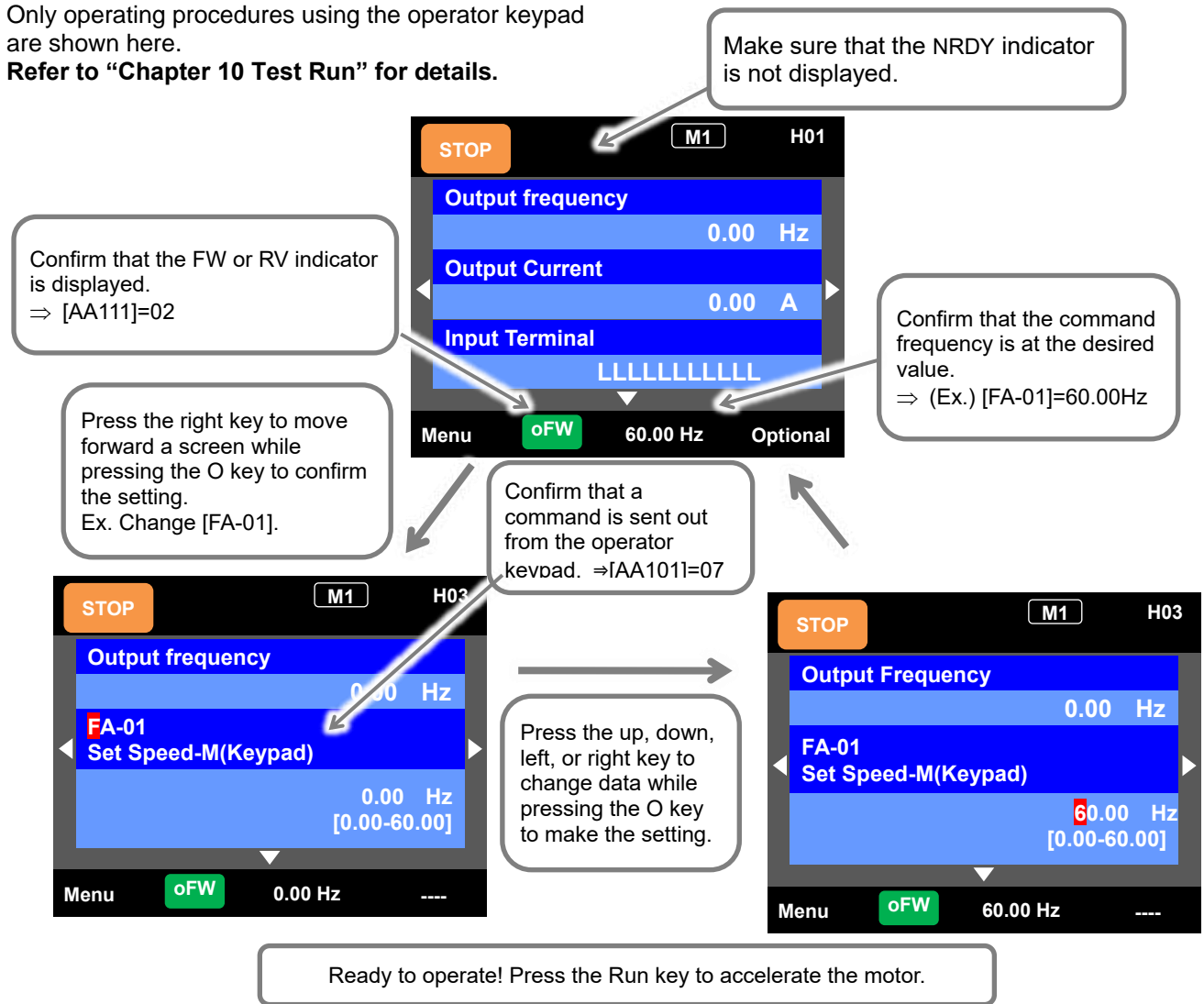

3.2.5 Troubleshooting

The motor does not rotate!
An error indication appears on the inverter.
 See “Chapter 18 Tips/FAQ/Troubleshooting”.

How to operate the operator keypad.
 See “Chapter 9 Operating”.

How to reduce noise, suppress harmonics and increase regenerative potential.
 See “Chapter 7 Wire Connection and Optional Devices”.

How to run the inverter using external signals.
 See “Chapter 10 Test Run” and “Chapter 11 Frequency References and RUN Commands Examples”.

How to run our inverter with communications.
 See “Chapter 14 RS485 Communication”.

How to use the inverter functions.
How to monitor the operating status.
 See “Chapter 12 Inverter Functions” and “Chapter 13 Information Monitor Functions”.

4





Chapter 4 Main Body of the Product

Contents

4.1 What This Chapter Explains	4-1
4.2 External Appearance of the Product.....	4-2
4.3 Model of the Product and Specification Label	4-3
4.3.1 Model of the Product.....	4-3
4.3.2 Specification Label.....	4-3
4.3.3 Indication for Japan.....	4-4

4.1 What This Chapter Explains

The chapter provides explanations of the main body of the product. The explanations include: the external appearance and model of the product, what's written on the specification label and inspection instruction upon purchase.

Symbol	Meanings
	General and troubleshooting questions
	Key points for a solution
	Notes
	Confirmation of procedures

4.2 External Appearance of the Product



- How to check the external appearance.

Operator Keypad
 A removable Visual LCD Operation Panel (VOP).
 The POWER and RUN LEDs are on it.
 (In this Guide, the operator keypad may be written simply as the abbreviation "VOP".)



- This chapter describes the product specification label etc. In this chapter, there are some figures with the terminal block cover removed for illustration.

* An example of P1-00330-LFF (P1-055LFF)

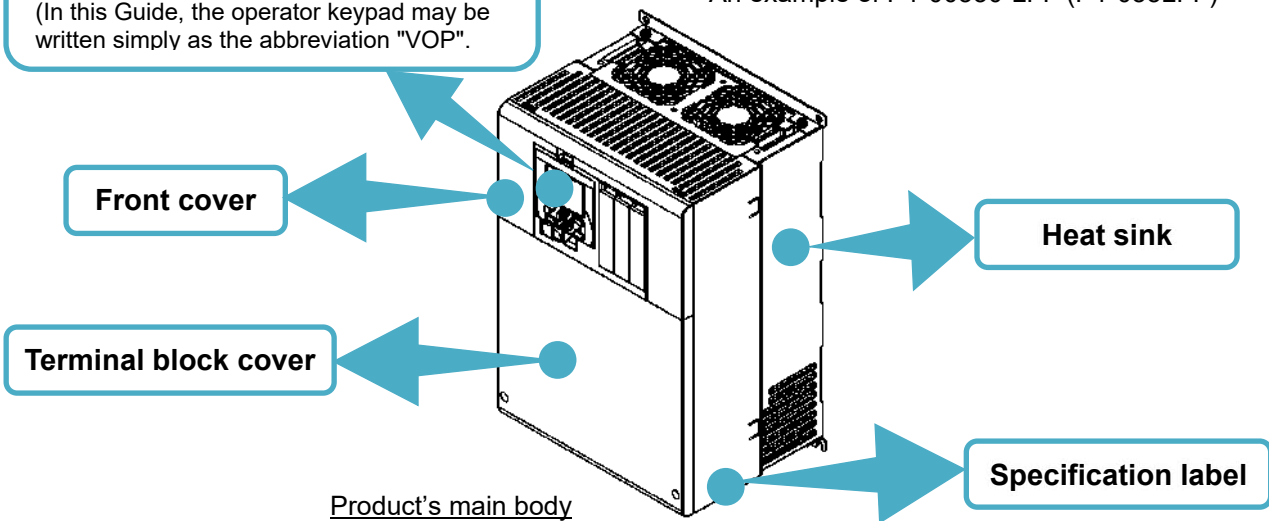

Optional cassette slots
 A maximum of three optional cassettes can be installed. (In preparation)

Control circuit terminal block
 Sends a command to the inverter and issues an alarm. Internal data can be imported into the external device through [Ao] or [FM] output terminal.

Main circuit terminal block
 Connects the power supply and motor. This is also used for connecting optional equipment such as reactor.

Backing plate

Product's main body
 (with a terminal block cover opened)

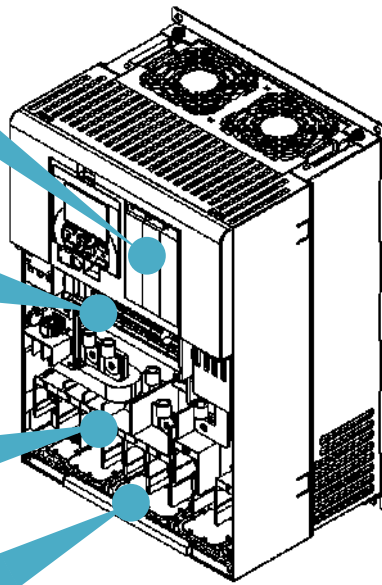

4.3 Model of the Product and Specification Label

4.3.1 Model of the Product



• How to read a model number.



• The model of the product is as follows:

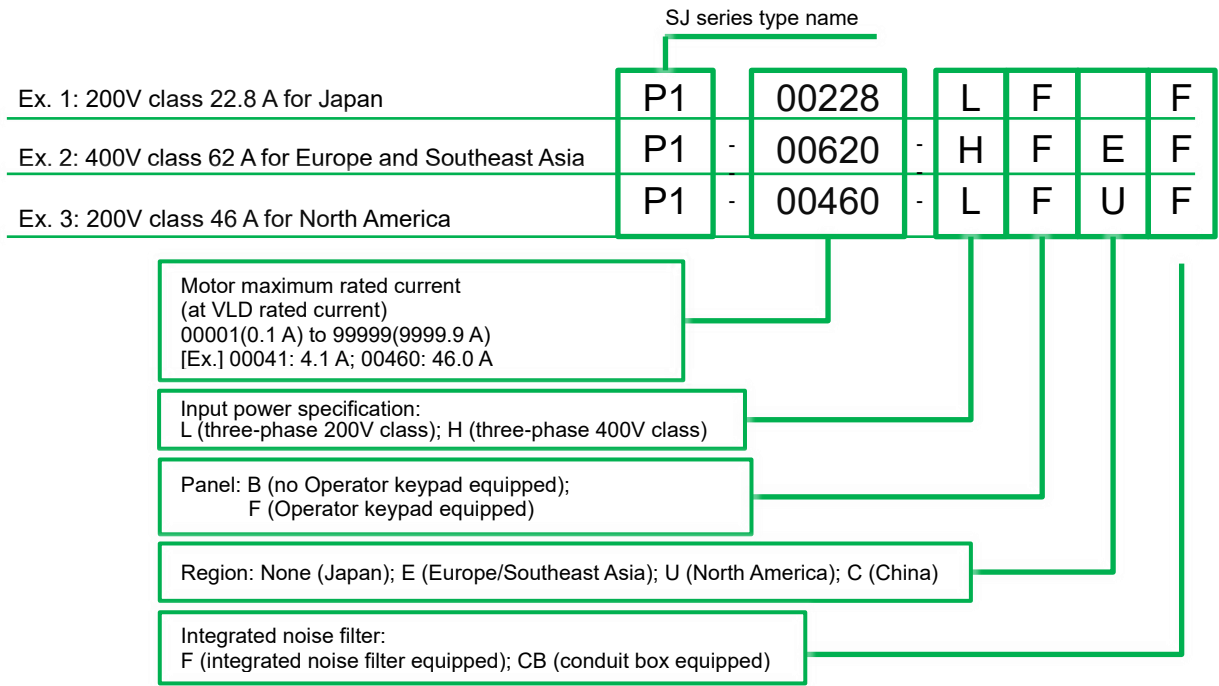

4.3.2 Specification Label



• What's written on the specifications label?

Example of a specification label:
P1-00330-LFF (P1-055LFF);



• The model of the product is indicated on the specification label on the side of the product. The details on the specification label are as follows:

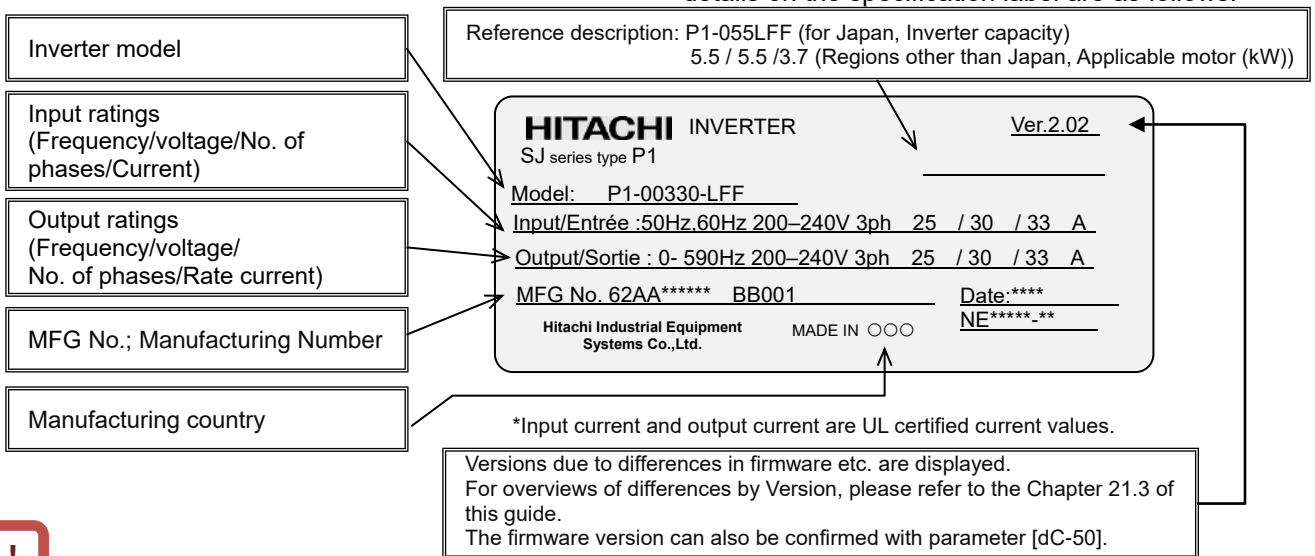

• In this Guide, some indications after input power specification may be omitted in the model name, in this case, however, the specifications provided are not concerned with the omitted indications.

• The input current value on the specification label is the value that complies with UL Standards.
• (*) shows the product-specific values.

4.3.3 Indication for Japan

Indication example:

P1-00330-LFF(P1-055LFF) for Japan

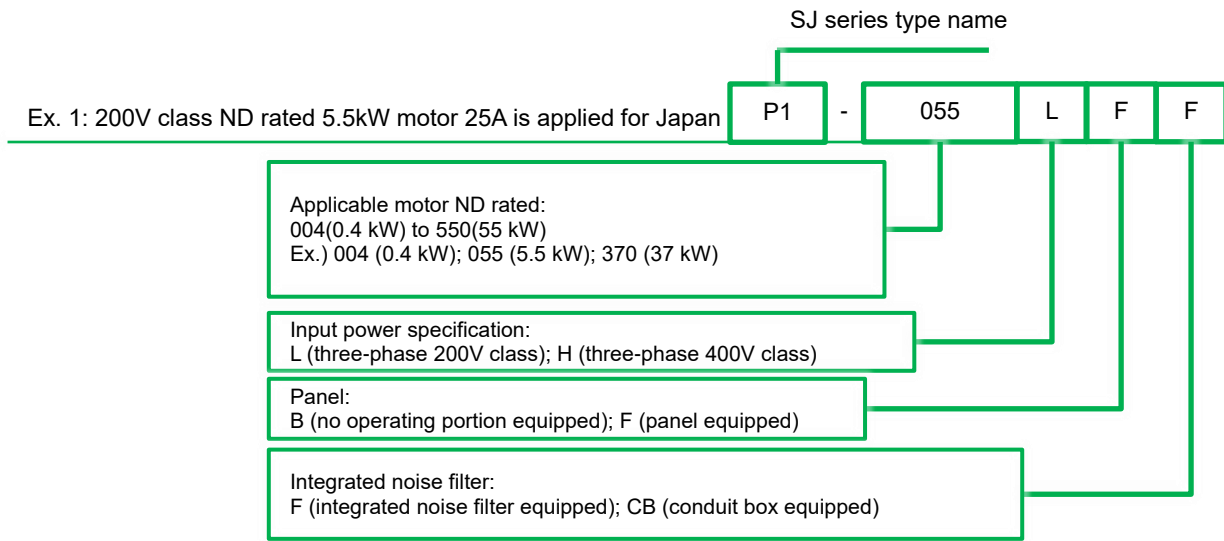

See “Chapter 20 Specifications” for the corresponding models.

5





Chapter 5 Included Items

Contents

5.1 What This Chapter Explains 5-1
5.2 Included Items 5-2
5.3 Inspection upon Purchase 5-3
 5.3.1 Checking When Opening the Package..... 5-3
 5.3.2 User’s Guide (this Guide) 5-3

5.1 What This Chapter Explains

This chapter describes included items that need to be checked upon purchase.

Symbol	Meanings
	General and troubleshooting questions
	Key points for a solution
	Notes
	Confirmation of procedures

5.2 Included Items



- What's included with the product



- Check included items.

The following is included in the package:

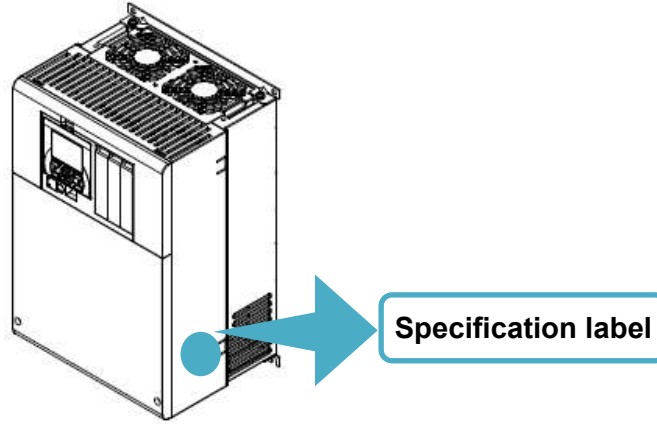

- Included Items

<p>Inverter body: 1</p>	<p>Basic Guide: 1 (Supplementary instructions and/or etc. may be bundled in some cases.)</p>

- Included items that vary depending on models (enclosed in the package)

<p>Enclosed in the P1-01240-L (P1-220L)</p>	<p>Enclosed in the P1-01850-L(P1-370L) to P1-02950-L(P1-550L) / P1-00930-H(P1-370H) to P1-06600-H(P1-3150H)</p>	<p>Enclosed in the P1-03720-H(P1-1600H) to P1-05500-H(P1-31500H) (For P1-06600-H(P1-3150H), included only the M12 bolts for the ground terminal. See chapter 6.2 for details.)</p>
<p>M3x8 screws : 4 pcs Spacer : 4 pcs</p>	<p>Eye bolts for lifting the inverter</p>	<p>• Supplemental terminal for braking unit connection (the shape differs depending on the model) and bolts for it. 1 pcs , M8x18 bolt : 2 pcs</p> <p>• Bolts for the grund terminal M12x20 bolt : 2 pcs</p>

Inverter body
Confirm that the model you ordered and the model name on the specification label are the same. Find an inverter in the package.

Basic Guide
Enclosed as a booklet. This guide is provided simple setup, test run and etc. basic contents.

Caution • Applying a different inverter voltage class or motor rated voltage from the specified input power voltage may lead to damage to your inverter or motor burnout.

Do • Check with the specification label to be sure that the inverter voltage class is correct.

* See “4.3.2 Specification Label”.

5.3 Inspection upon Purchase





- What's needed to be checked upon purchase

5.3.1 Checking When Opening the Package



- Check the items on the right when you open the package.
- If you find any faults or defects in the product or have any question about the product, please contact your supplier or local Hitachi inverter sales office.

 Check the product for damage (including falling of parts and dents in the inverter body) caused during transportation.

 Upon opening the product package, check that the package contains an inverter set and the Basic Guide.

 Check the specification label again to confirm that the product is the one you have ordered.

5.3.2 User's Guide (this Guide)



- The Guide describes how to handle and maintain the Hitachi SJ series inverter type P1. Read the Guide carefully before using the inverter. Keep the "User's Guide" at hand.
- If you use the inverter with optional products, you should also read the instruction manuals enclosed with those products.
- Note that the Basic Guide and the instruction manuals for each optional product to be used should be delivered to the end user of the inverter. For the User's Guide and instruction manual, please contact your supplier or local Hitachi inverter sales office.

(Memo)



Chapter 6 Installation

Contents

6.1 What This Chapter Explains	6-1
6.2 Installation Environment	6-2
6.3 External Dimensions	6-7

6.1 What This Chapter Explains

This chapter describes the installation of the inverter. Before installing the inverter, make sure to carefully read “Chapter 1 Safety Instructions/Risks” for safety work.

6.2 Installation Environment

◆ Transportation



The inverter uses plastic parts. When carrying the inverter, handle it carefully to prevent damage to the parts.



Do not install and operate the inverter if it is damaged or parts are missing.



Do not carry the inverter by holding the front or terminal block cover. Doing so may cause the inverter to fall.



Fall

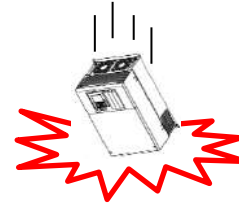

◆ Ambient temperature



Avoid installing the inverter in a place where the ambient temperature goes above or below the allowable range, as defined by the standard inverter specification.



Leave sufficient space around the inverter. Measure the temperature in a position about 5 cm from the bottom-center point of the inverter, and check that the measured temperature is within the allowable range. Operating the inverter at a temperature outside this range will shorten the inverter life (especially the capacitor life).



Temperature requirements

* Temperature requirements vary depending on the “Load type selection [Ub-03]”. See “Chapter 20 Specifications”. Carrier derating may be required.

◆ Humidity



Avoid installing the inverter in a place where the relative humidity goes above or below the allowable range (20% to 90% RH), as defined by the standard inverter specification. Avoid a place where the inverter is subject to condensation.



Condensation inside the inverter will result in short circuits and malfunctioning of electronic parts. Also avoid places where the inverter is exposed to direct sunlight.



20 to 90%RH



Water drops



Direct sunlight

◆ Ambient air



Avoid installing the inverter in a place where the inverter will be subject to dust, water drops, corrosive gases, combustible gases, flammable gases, grinding fluid mist, or salt water.



Foreign particles entering the inverter will cause it to fail. If you use the inverter in a considerably dusty environment, install the inverter inside a totally enclosed panel.

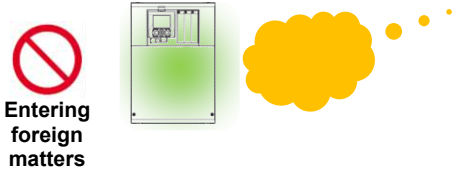

◆ Installation method and position



Install the inverter vertically and securely with screws or bolts on a surface that can bear the inverter weight and is free from vibrations.



If the inverter is not installed vertically, its cooling performance may be degraded and tripping or inverter damage may result.

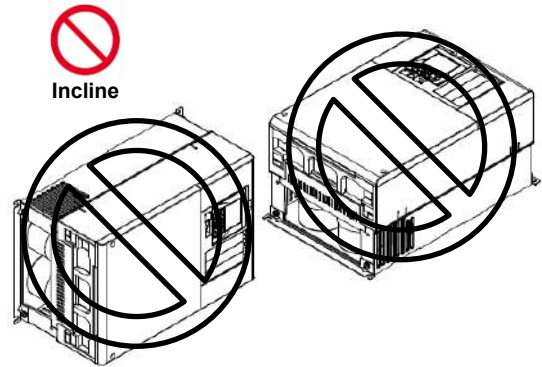
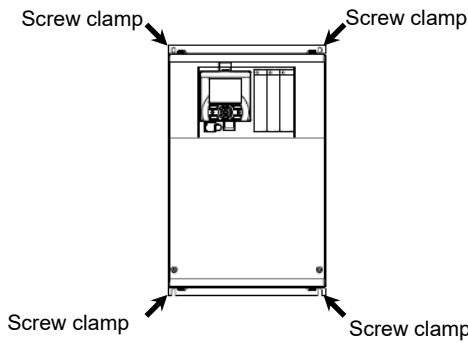

◆ Mounting in an enclosure



When mounting multiple inverters in an enclosure with a ventilation fan, carefully design the layout of the ventilation fan, air intake port, and inverters. An inappropriate layout will reduce the inverter-cooling effect and raise the ambient temperature. Plan the layout so that the inverter ambient temperature will remain within the allowable range. A ventilation fan located directly above the inverter could drop dust on it. To prevent this, move the inverter horizontally to a suitable position.

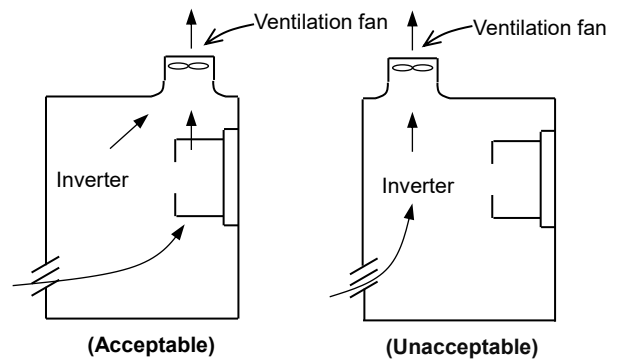

Position of ventilation fan

◆ Surface on which to install the inverter



The inverter will reach a high temperature (up to about 150°C) during operation. Install the inverter on a vertical wall surface made of nonflammable material (e.g., metal) to avoid the risk of fire.



Leave sufficient space around the inverter. Keep sufficient distance between the inverter and other heat sources (e.g., braking resistors and reactors) so that the heat discharged from the heat sources does not affect the inverter.

For P1-00044-L to P1-02950-L (P1-004L to P1-550L),
P1-00041-H to P1-01470-H (P1-007H to P1-550H).

For P1-01760-H to P1-06600-H (P1-750H to P1-3150H).

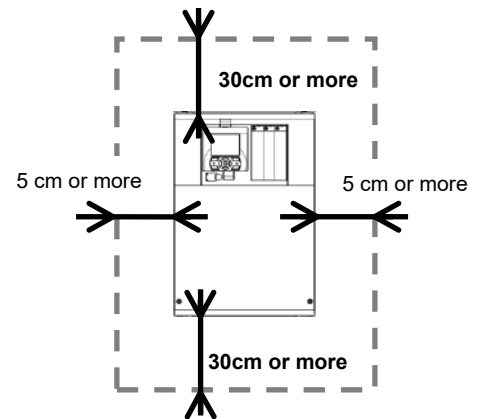
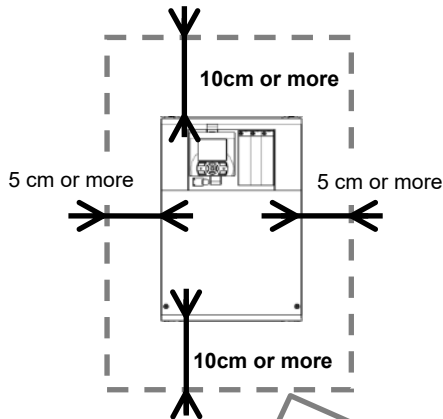

* A clearance of 22 cm or more is required below the inverter to replace aged parts for the following models:
 • P1-00800-LFF (P1-150LFF) to P1-01240-LFF (P1-220LFF)
 • P1-00400-HFF (P1-150HFF) to P1-00620-HFF (P1-220HFF)
 * The inverter needs to be removed to replace aged parts for the following models:
 • P1-00044-LFF (P1-004LFF) to P1-00600-LFF (P1-110LFF)
 • P1-00041-HFF (P1-007HFF) to P1-00310-HFF (P1-110HFF)

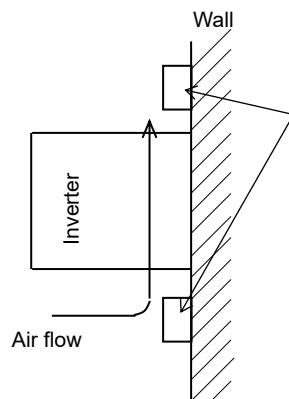

Keep enough clearance between the inverter and the wiring ducts located above and below the inverter to prevent the latter from obstructing the ventilation of the inverter.

* See “Chapter 20 Specifications” or this chapter for the dimension drawing of the inverter.

◆ Reduction of enclosure size



- An inverter installation that heat sink is outside enclosure can reduce heat emission within the enclosure and reduce the size of enclosure.
 - The models P1-00044-L to P1-00228-L (P1-004L to P1-037L) and P1-00041-H to P1-00126-H (P1-007H to P1-037H) requires mounting metal brackets prepared by the customer. (*)
 - Models other than the above can be supported by removing the mounting brackets already attached on the inverter and reattaching them to the mounting location for the outside heat sink installation. Cut the mounting surface of the enclosure depending on the panel cut dimensions. (*)
- (*) Please contact us for details such as dimensional drawings.



- The cooling section (including the heat sink) positioned outside the enclosure has a cooling fan. Therefore, do not place the enclosure in any environment where it will be subject to dust, water drops, corrosive gases, combustible gases, flammable gases, grinding fluid mist, or salt water.
- The heat sink part reaches a high temperature. Install a protection cover as needed.

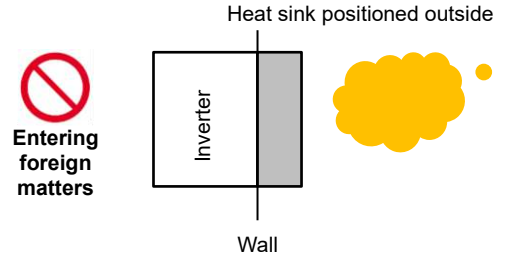

- Even if the enclosure designed by external heat sink installation, please considering that 30% of the loss by the inverter is radiated into the enclosure.

■ Watt loss (W) (at 100% load, approximate)

Model name P1-****-L	00044	00080	00104	00156	00228	00330	00460	00600	00800	00930	01240	01530	01850	02290	02950	
ND Rating Code P1-***L	004	007	015	022	037	055	075	110	150	185	220	300	370	450	550	
calorific value (W)	ND	50	65	93	142	225	348	376	498	742	964	1163	1317	1534	1625	1878
	LD	53	80	118	162	253	365	400	625	922	1167	1263	1536	1801	1940	2669
	VLD	65	105	135	197	314	420	520	754	1059	1332	1377	1698	2092	2300	3046

Model name P1-****-H	00041	00054	00083	00126	00175	00250	00310	00400	00470	00620	00770	00930	01160	01470	01760	
ND Rating Code P1-***H	007	015	022	037	055	075	110	150	185	220	300	370	450	550	750	
calorific value (W)	ND	62	94	96	145	235	240	260	361	495	687	783	812	1047	1130	1570
	LD	67	98	107	163	260	280	306	444	601	805	854	880	1218	1488	1811
	VLD	76	104	134	189	290	306	380	482	633	860	920	971	1300	1592	2020

Model name P1-****-H	02130	02520	03160	03720	04320	04860	05200	05500	06600	
ND Rating Code P1-***H	900	1100	1320	1600	1850	2000	2200	2500	3150	
calorific value (W)	ND	2034	2219	3872	3896	4091	4514	4710	5750	7545
	LD	2150	2397	4352	4379	4598	4622	5251	6250	7875
	VLD	2359	2557	4598	4627	4858	5533	5689	-	-

✧ These data are reference values of our site and vary depending on the power supply environment and the motor power factor.

◆ Be careful when lifting the inverter !



Procedure to hang an inverter.

When lifting the inverter, Please lift according to the figure below!

(1) Vertical Slinging.

When lifting vertically, fasten the supplied lifting bolts on the top left and right. Use an appropriate sling tool to achieve an appropriate swing angle in order to maintain sufficient load capacity considering the weight of the inverter.

(P1-01850-L(P1-370L) to P1-02950-L(P1-550L)
/P1-00930-H(P1-370H) to P1-06600-H(P1-3150H))

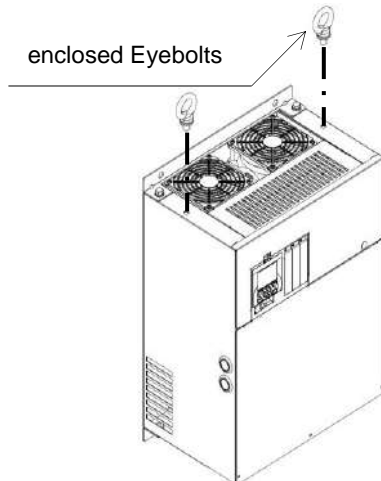

(2) Horizontal Slinging.

(P1-03720-H(1600H) to P1-06600-H(3150H))
Shift the pre-fixed eyebolts ① and ② to front cover side and screw tightly.

Fix the bundled eyebolts ③ and ④ to the front cover side at 2 points on the lower side and screw tightly.

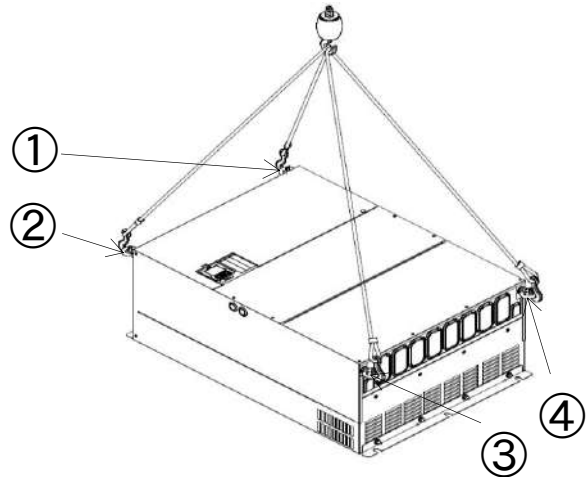

◆ For models of 400V160kW or more, refer to the following when using both the DC link choke for power factor correction and braking unit.

- When using both the DC link choke for power factor correction and the braking unit, remove short bar between PD-P. Then connect to the P terminal the supplemental terminal for the braking unit connection(*1), and over it connect the DC link choke wire as shown in the picture. After, connect the braking unit P terminal wire (*2) to the M8 terminals of supplemental terminal. Be sure to use the bundled M8 bolts for the braking unit connection.
- With P1-06600-H(P1-3150H) model, the supplemental terminal for the braking unit connection is not bundled. For any inquiries about wiring, please contact your supplier or local Hitachi sales office.
- In case the ground terminals does not have any bolt connected to them, use the bundled M12 bolts for the ground connection and make sure to fix them tightly.

(*1) The shapes of "supplemental terminal for braking unit connection" varies depending on the model.

(*2) In this case, consider the wire size depending on the customer system referring to chapter 7.5.4.

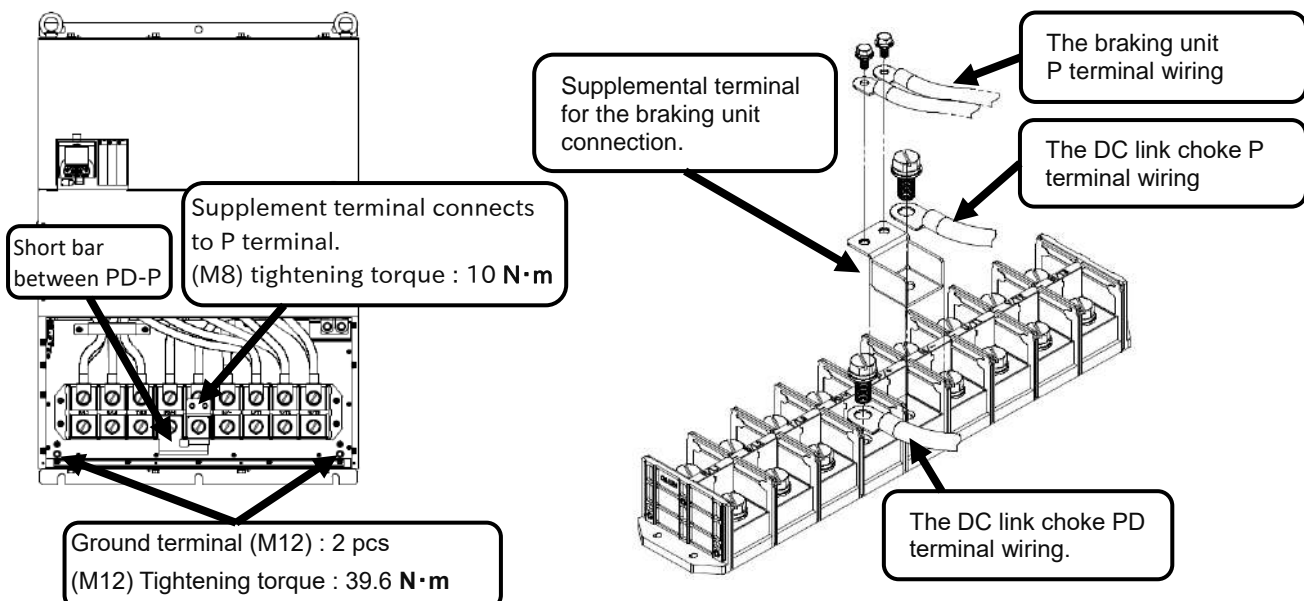

6.3 External Dimensions

Model P1-****-(P1-****)			
200 V class: 00044-L (004L), 00080-L (007L), 00104-L (015L), 00156-L (022L) , 00228-L (037L)			
400V class: 00041-H (007H), 00054-H (015H), 00083-H (022H), 00126-H(037H)			
Dimension	W(mm)	H(mm)	D(mm)
	150	255	140

(Example of description)

See “Chapter 20 Specifications” for corresponding details.

For example, 00330-L(055L) indicates that VLD rated current is 33.0A (ND rated motor capacity is 5.5kW), and L indicates 200V class while H indicates 400V class.

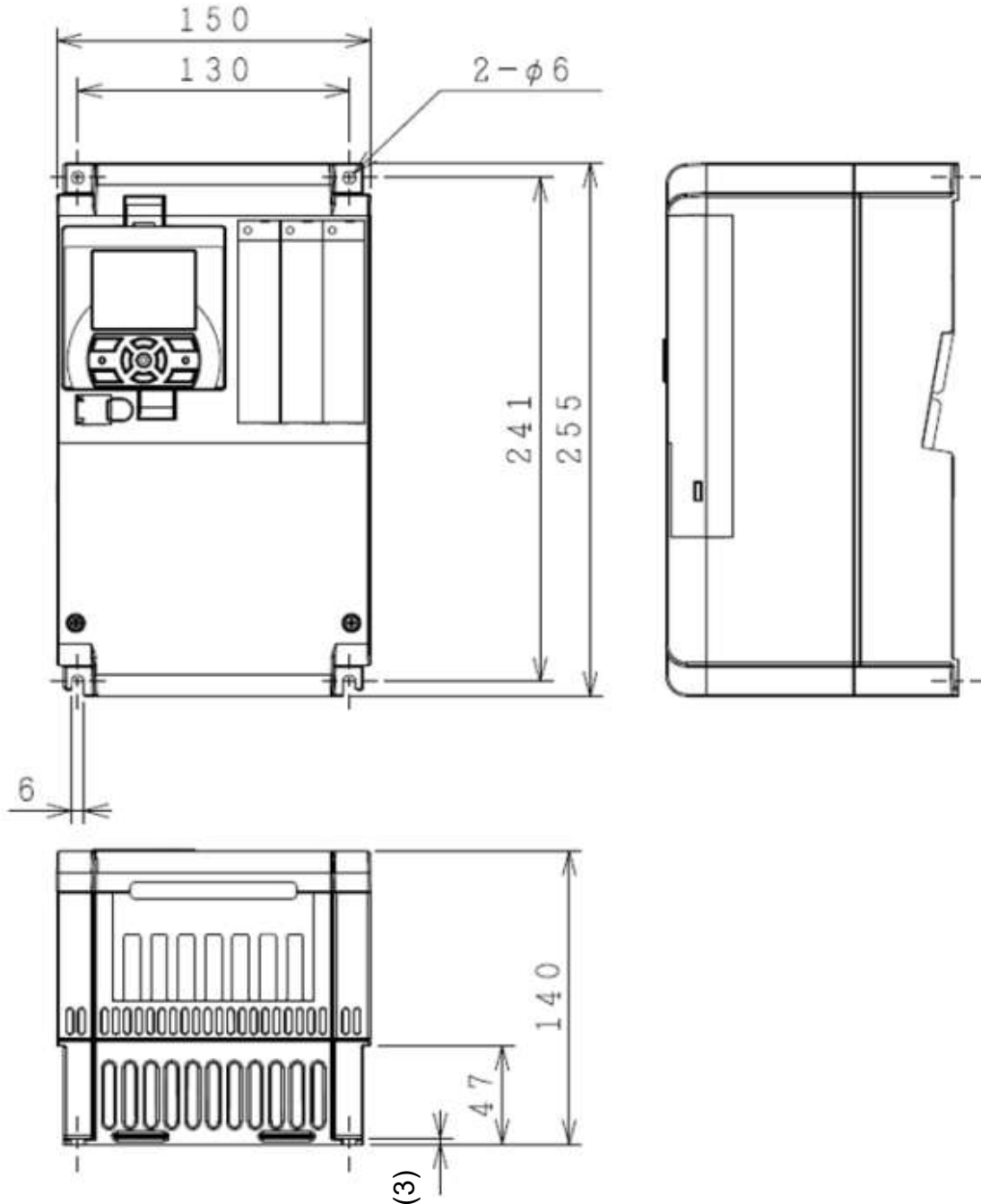

Model P1-****-(P1-****)			
200V class: 00330-L(055L), 00460-L(075L), 00600-L(110L)			
400V class: 00175-H(055H), 00250-H(075H), 00310-H(110H)			
Dimension	W (mm)	H (mm)	D (mm)
	210	260	170

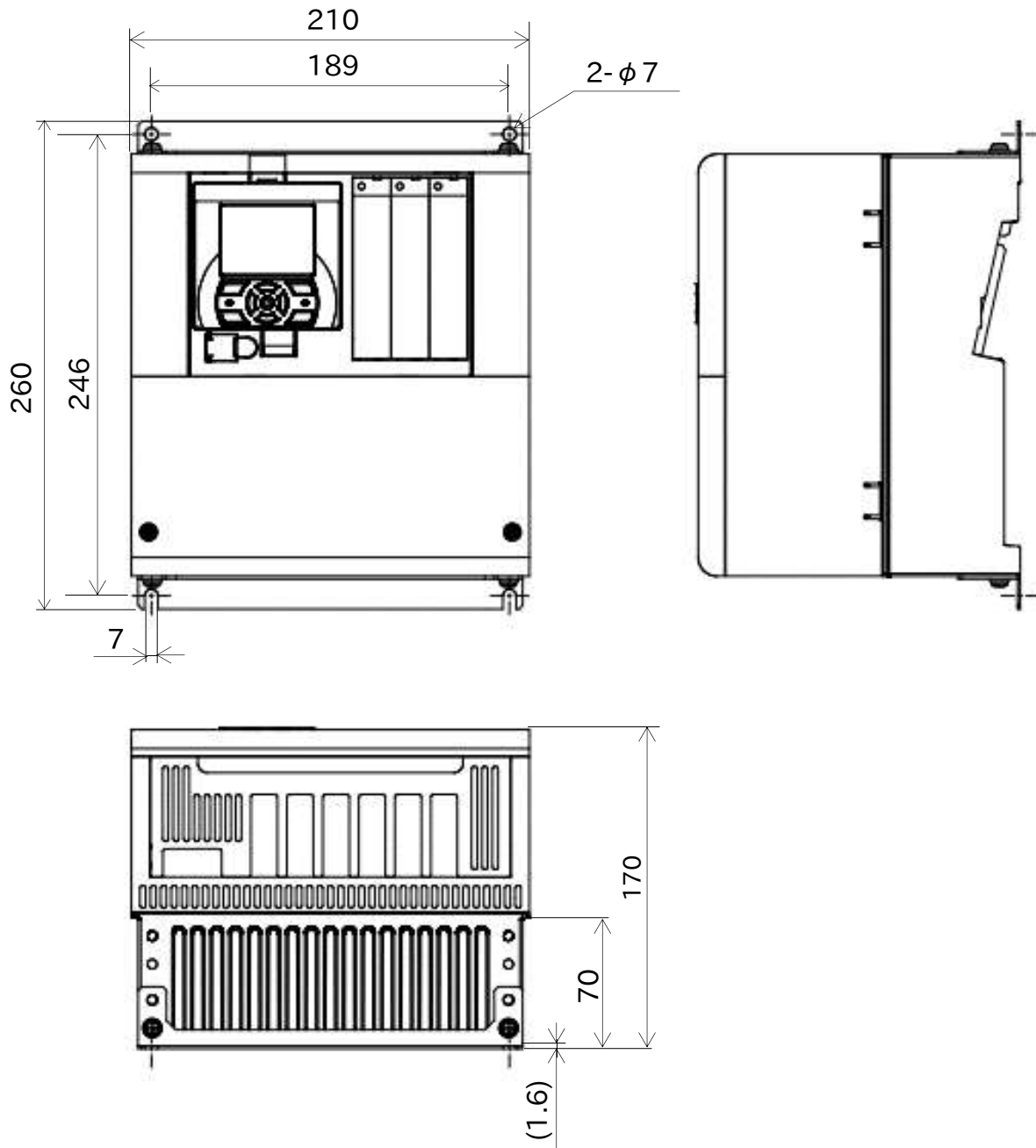

◆ Notes for P1-00600-L (P1-110L)



For the use of P1-00600-L (P1-110L) at low duty (LD)/very low duty (VLD), follow the installation procedures shown in the figure below.

Change [Ub-03] to 00 and [Ub-03] to 01 to set VLD and LD, respectively.

Procedures:

- (1) Remove four truss head screws that hold the (upper and lower) brackets provided by factory configuration.
- (2) Change the position of the screw holes for the (upper and lower) brackets.
- (3) Tighten the (upper and lower) brackets using four truss head screws removed in (1). (Tightening torque 2.2 to 2.5 Nm)
- (4) Install P1-00600-L (P1-110L) on the wall using four screws prepared on your own.

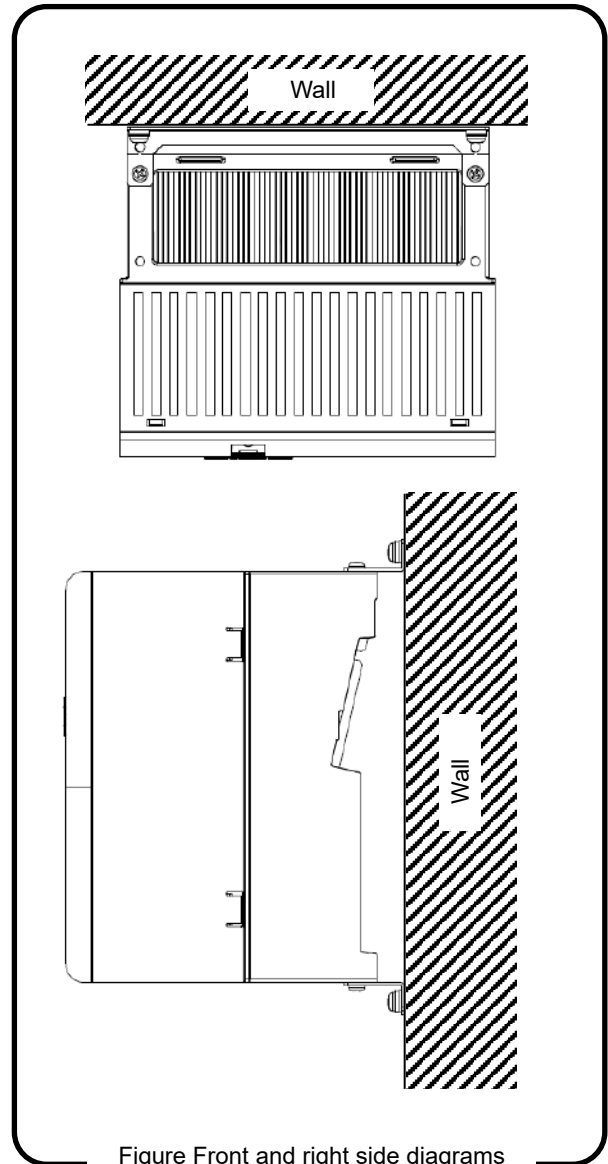
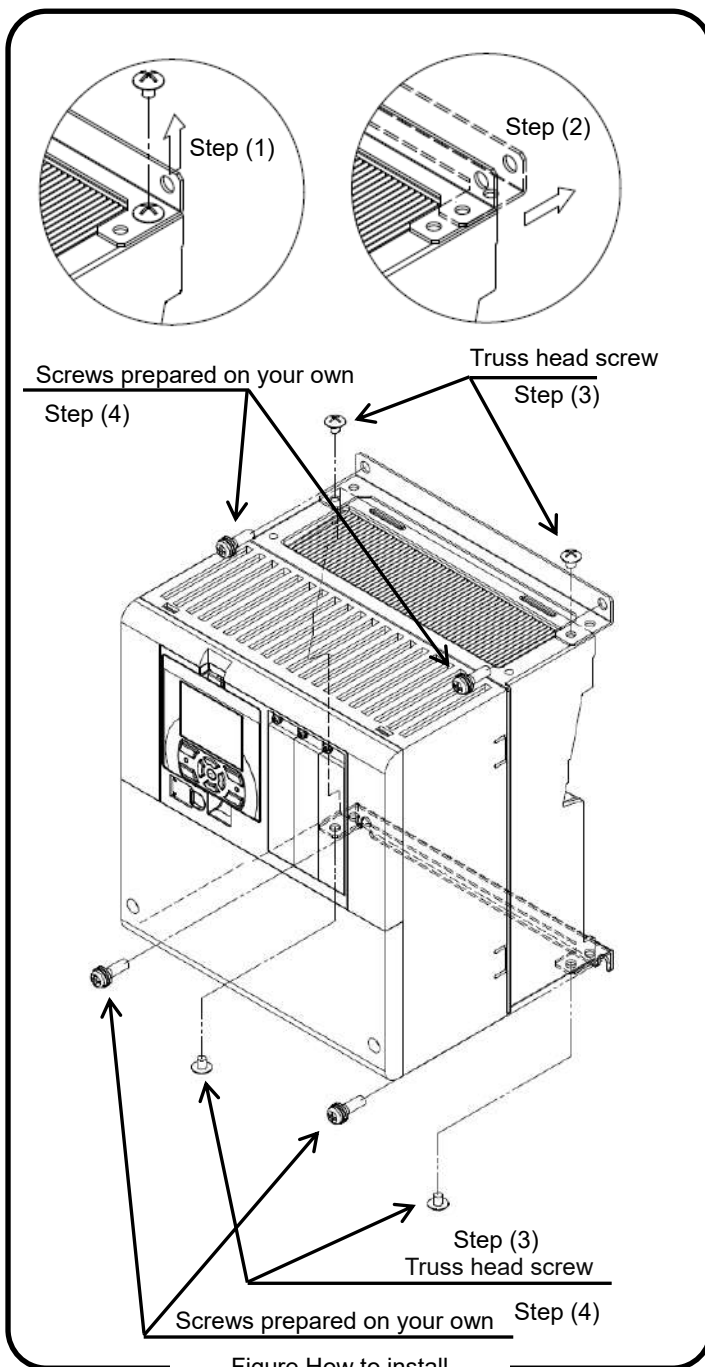

※Note

By shifting the mounting bracket, the depth dimension of the inverter increases by 15 mm. Please check for any problems when installing the inverter in the cabinet or etc.

Model P1-****-(P1-****)			
200V class: 00800-L (150L), 00930-L (185L), 01240-L (220L)			
400V class: 00400-H (150H), 00470-H (185H), 00620-H (220H)			
Dimension	W (mm)	H (mm)	D (mm)
	245	390	190

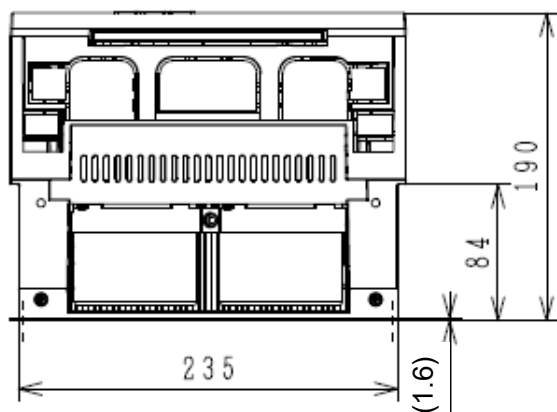
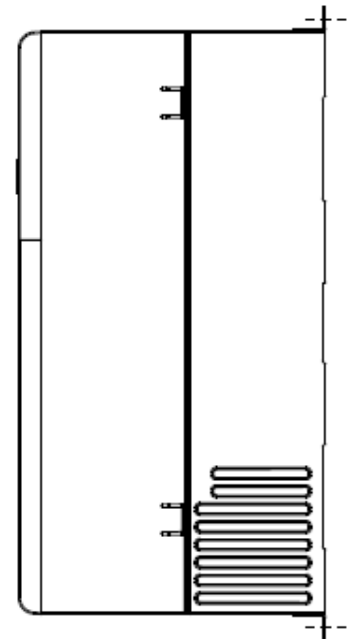
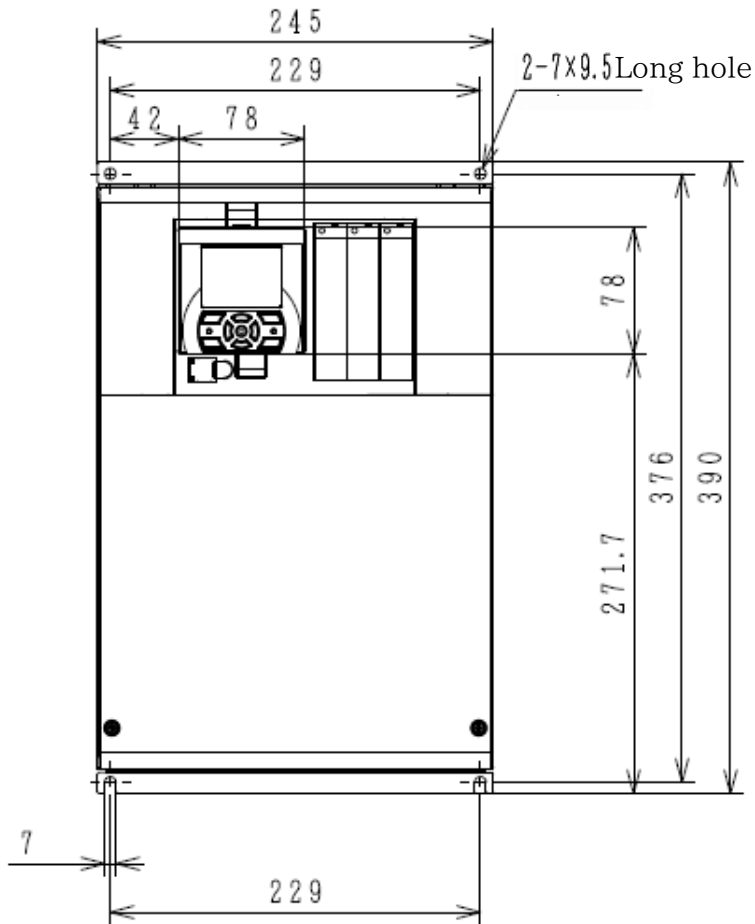

◆ Notes for P1-01240-L (P1-220L)



For the use of P1-01240-L(P1-220L) at very low duty (VLD), follow the installation procedures shown in the drawings below.

Change [Ub-03] to 00 to set VLD.

Procedures:

- (1) Tighten (four) spacers to the (upper and lower) brackets as shown in figure below, using bundled (four) M3×8 screws included in the package. (Tightening torque 0.6 to 0.8 N·m)
- (2) Install P1-01240-L(P1-220L) on the wall using four screws prepared on your own.

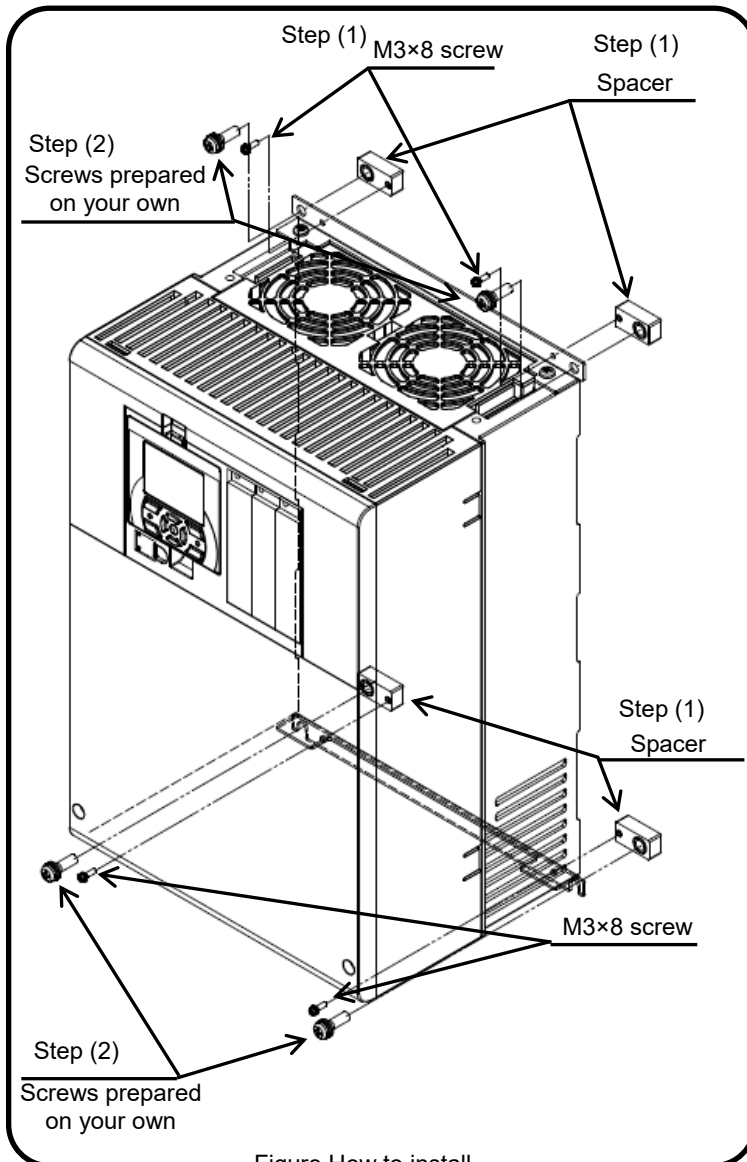

Figure How to install

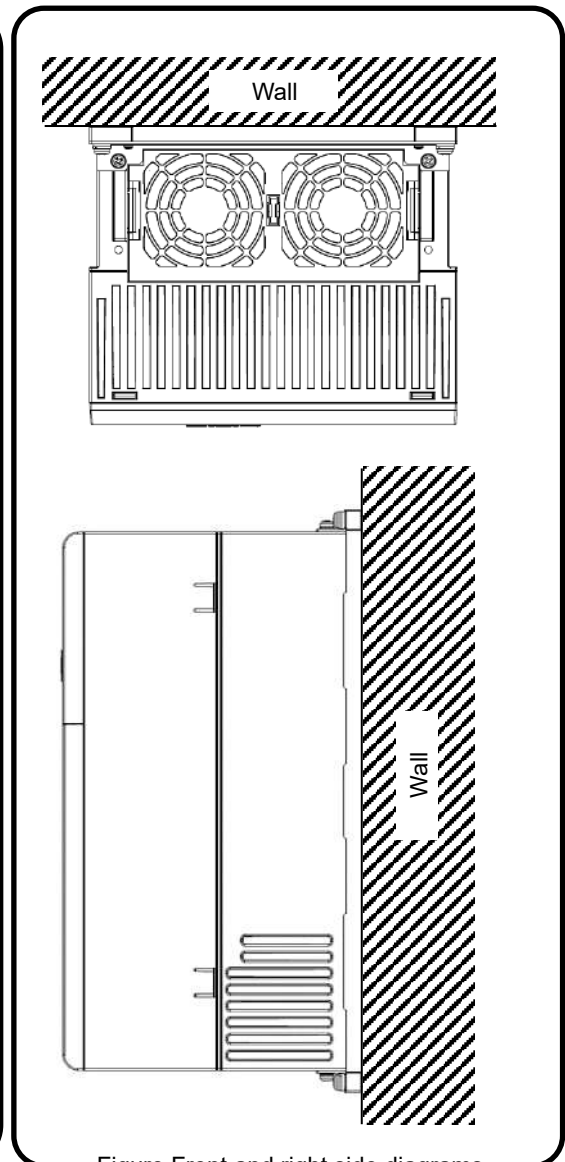
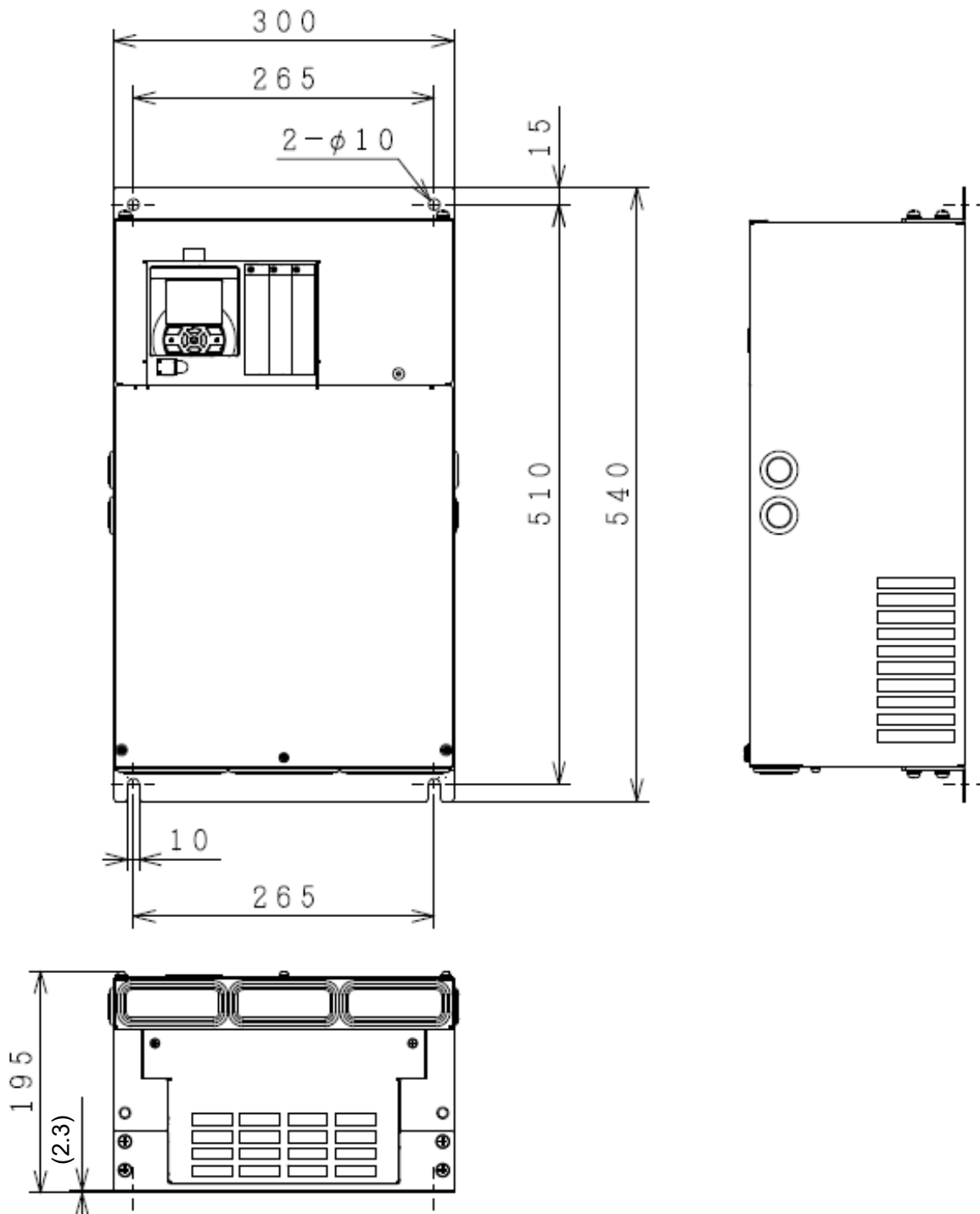

Figure Front and right side diagrams

※Note

By adding spacers, the depth dimensions of the inverter increase by 10 mm.
Please check for any problems when installing the inverter in the cabinet or etc.

Model P1-****-(P1-****)			
200V class: P1-01530-L (P1-300L)			
400V class: P1-00770-H (P1-300H)			
Dimension	W (mm)	H (mm)	D (mm)
	300	540	195



Model P1-****-(P1-****)			
200V class: P1-01850-L (P1-370L), P1-02290-L (P1-450L)			
400V class: P1-00930-H (P1-370H), P1-01160-H (P1-450H), P1-01470-H (P1-550H)			
Dimension	W (mm)	H (mm)	D (mm)
	390	550	250

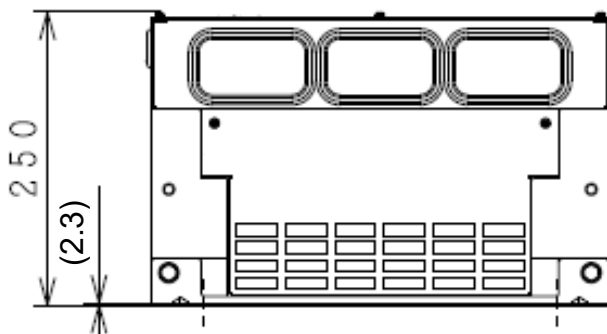
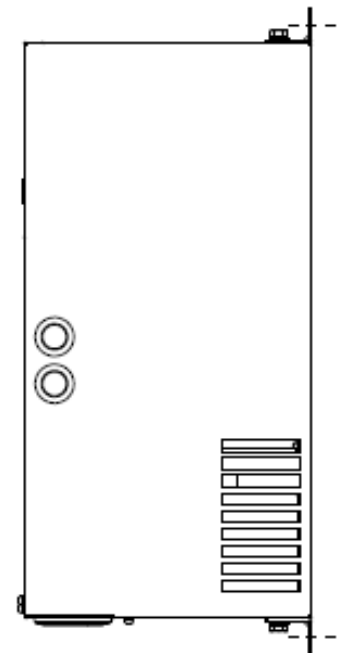
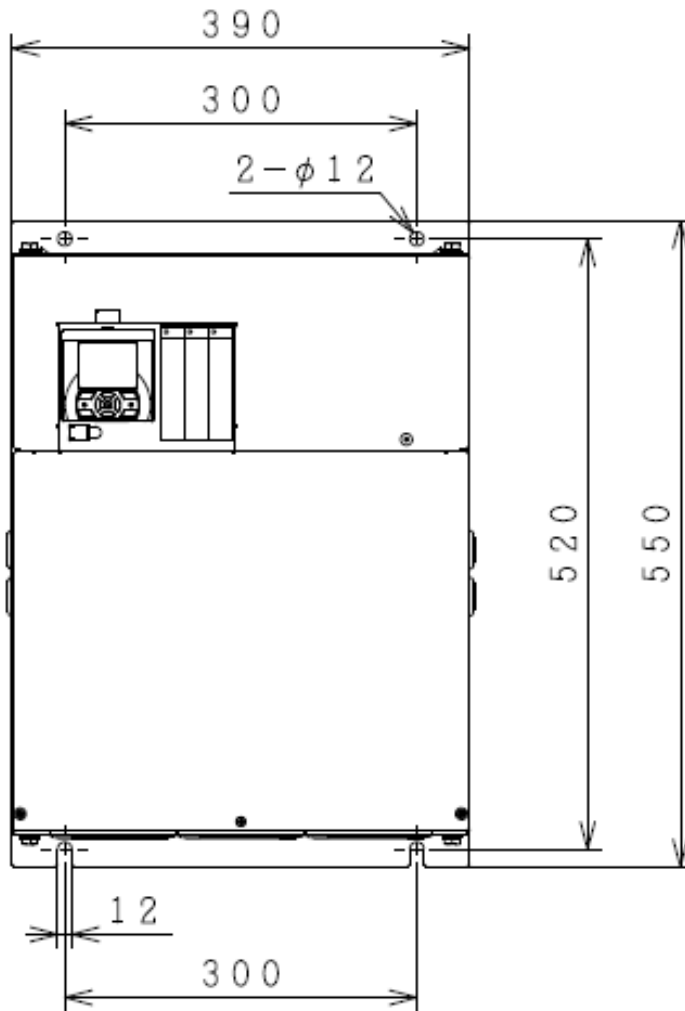

Model P1-****-(P1-****)			
200V class: P1-02950-L (P1-550L)			
Dimension	W (mm)	H (mm)	D (mm)
	480	700	250

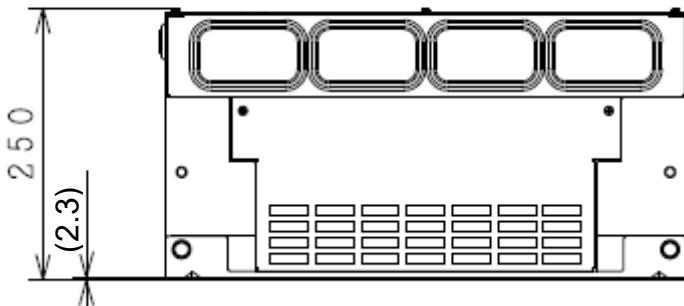
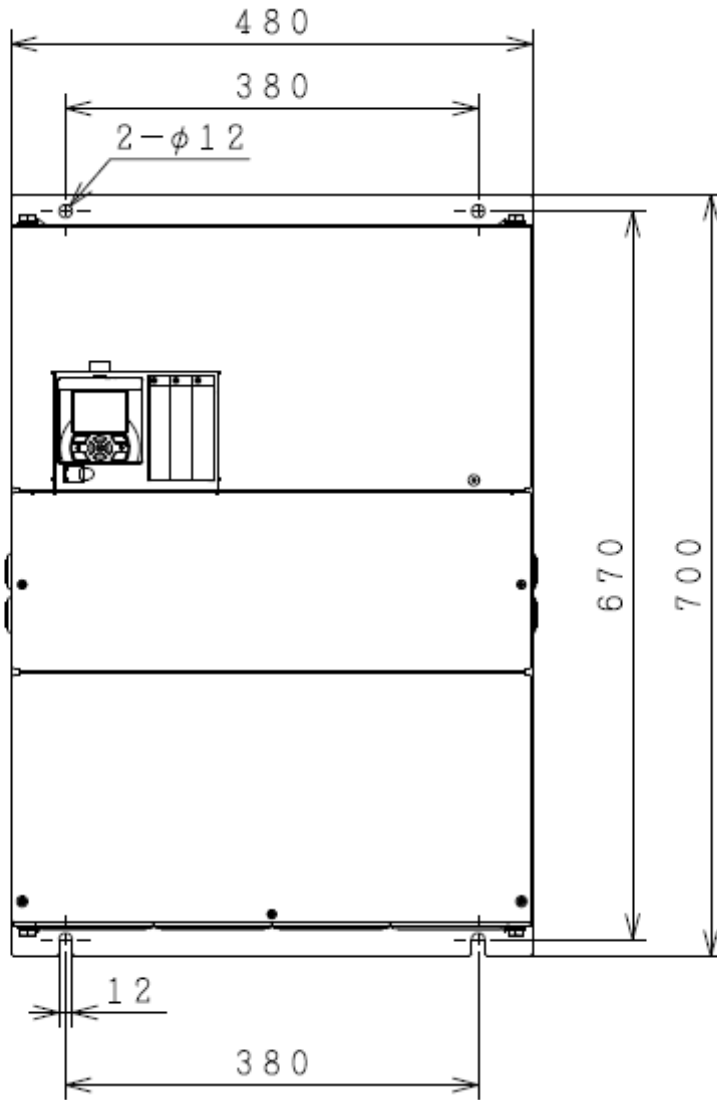

Model P1-****-(P1-****)			
400V class: P1-01760-H(750H), P1-02130-H(900H)			
Dimension	W (mm)	H (mm)	D (mm)
	390	700	270

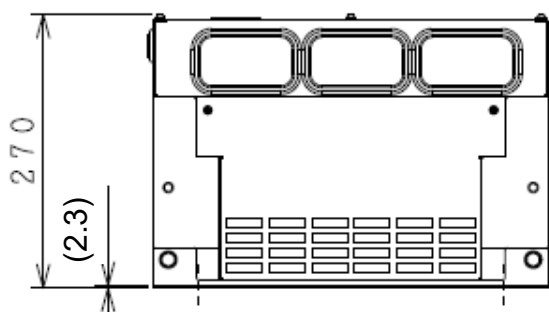
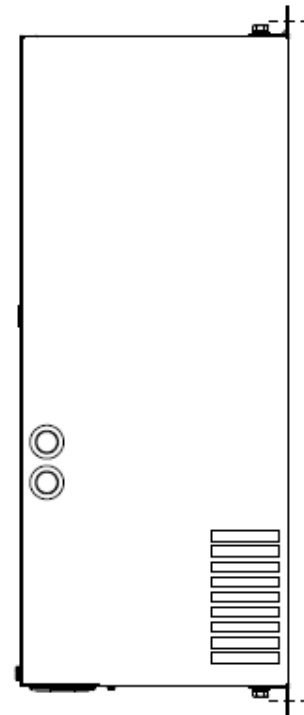
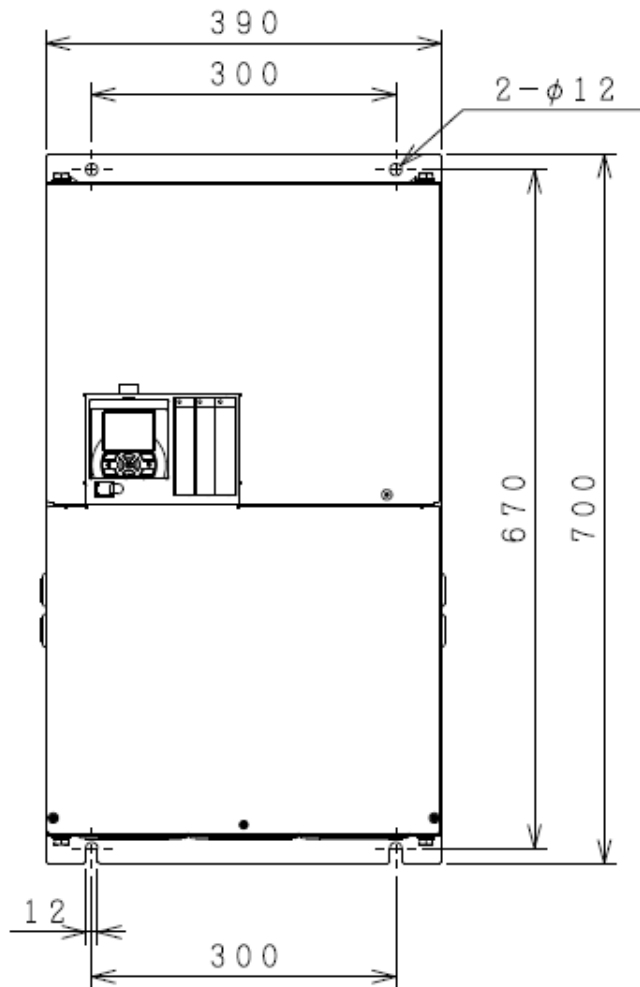

Model P1-****-(P1-****)			
400V class: P1-02520-H(1100H), P1-03160-H(1320H)			
Dimension	W (mm)	H (mm)	D (mm)
	480	740	270

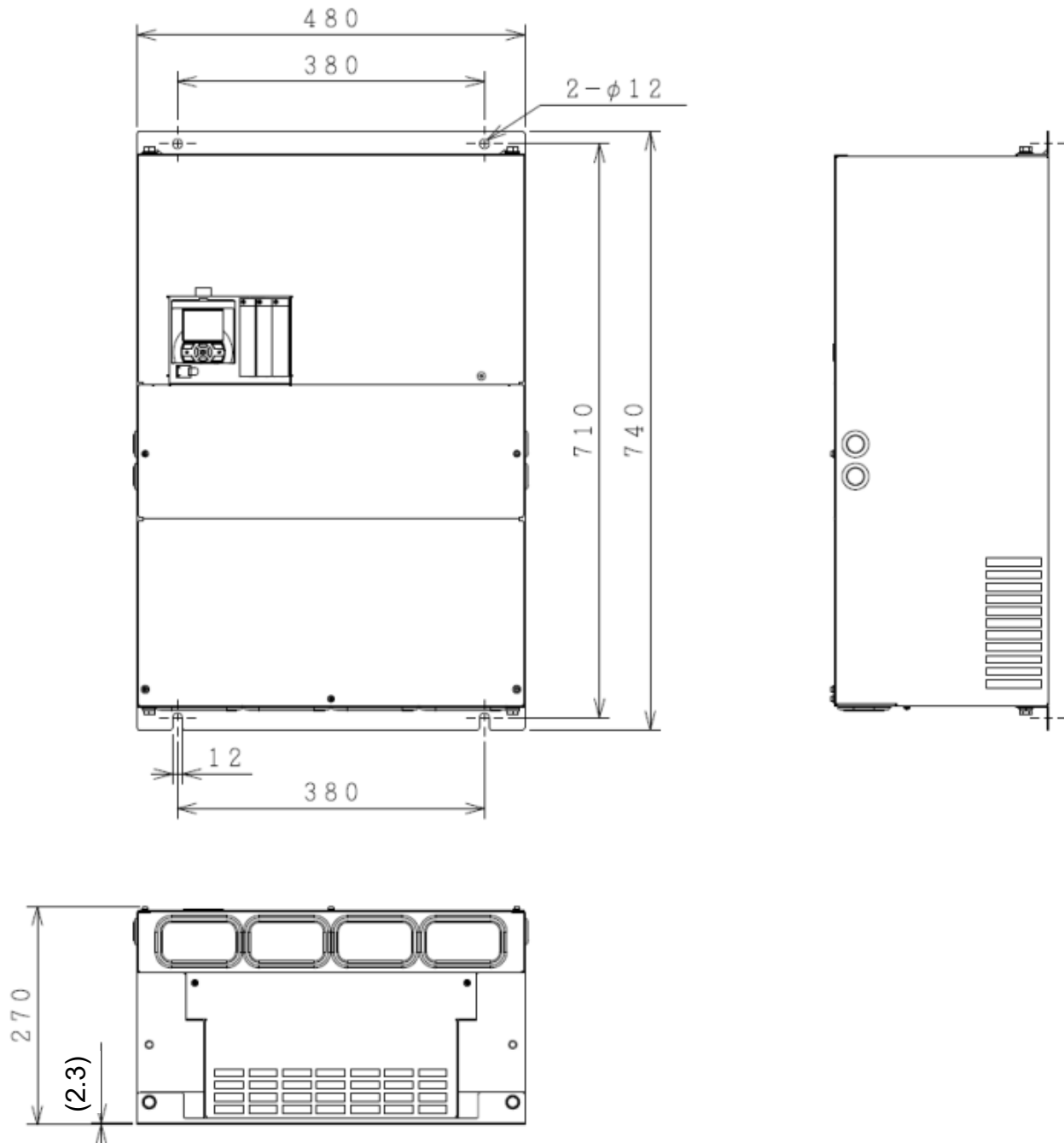

Model P1-****-(P1-****)			
400V class:03720-H(1600H)			
Dimension	W(mm)	H(mm)	D(mm)
	480	995	370

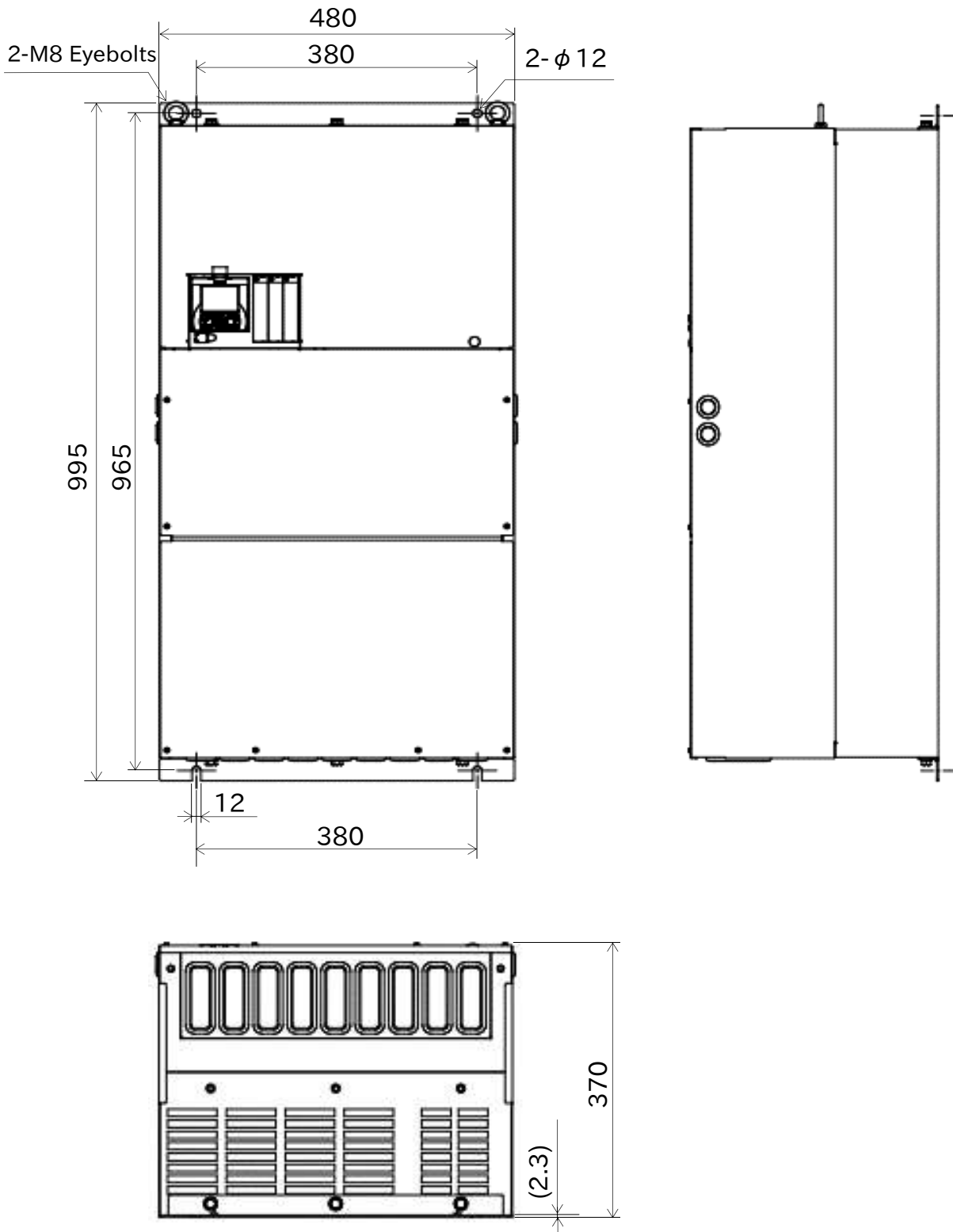

Model P1-****-(P1-****)			
400V class:04320-H(1850H)			
Dimension	W(mm)	H(mm)	D(mm)
	680	995	370

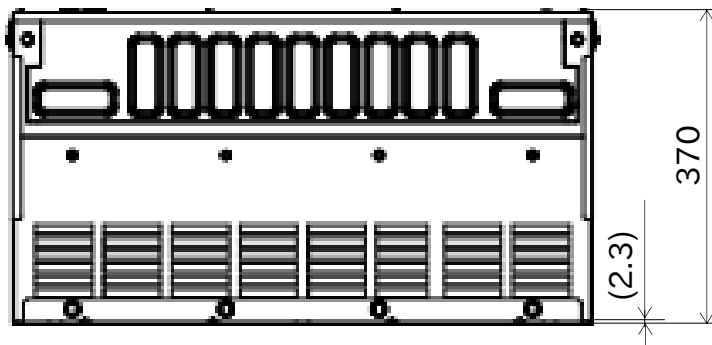
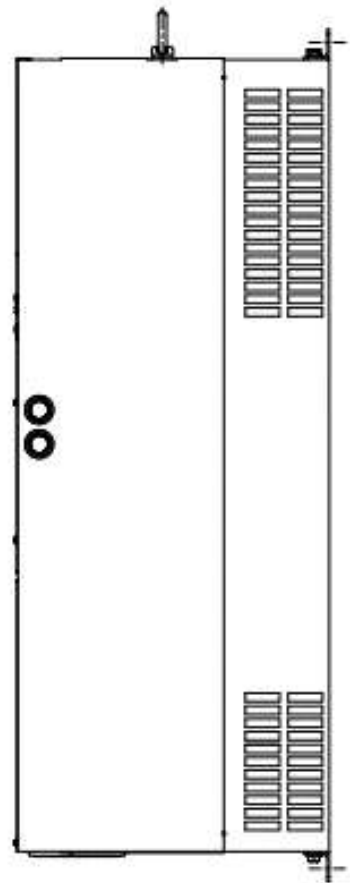
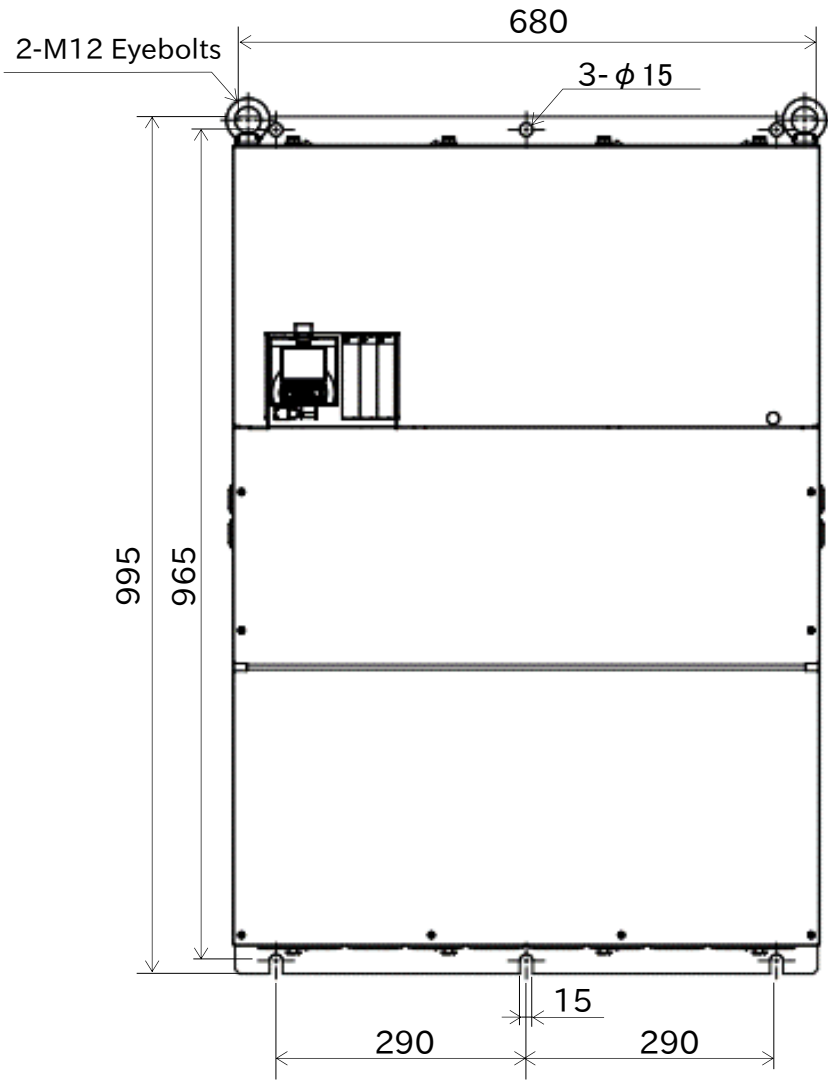

Model P1-****-(P1-****)			
400V class:04860-H(2000H), 05200-H(2200H), 05500-H(2500H)			
Dimension	W(mm)	H(mm)	D(mm)
	680	995	370

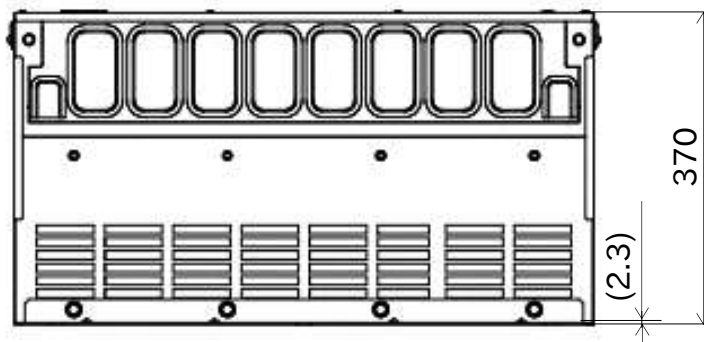
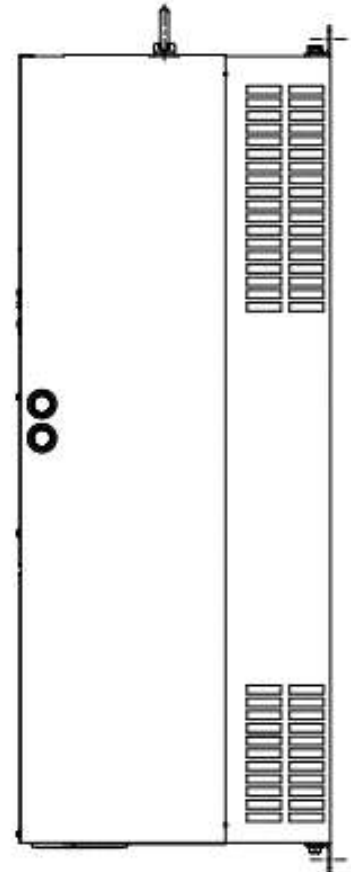
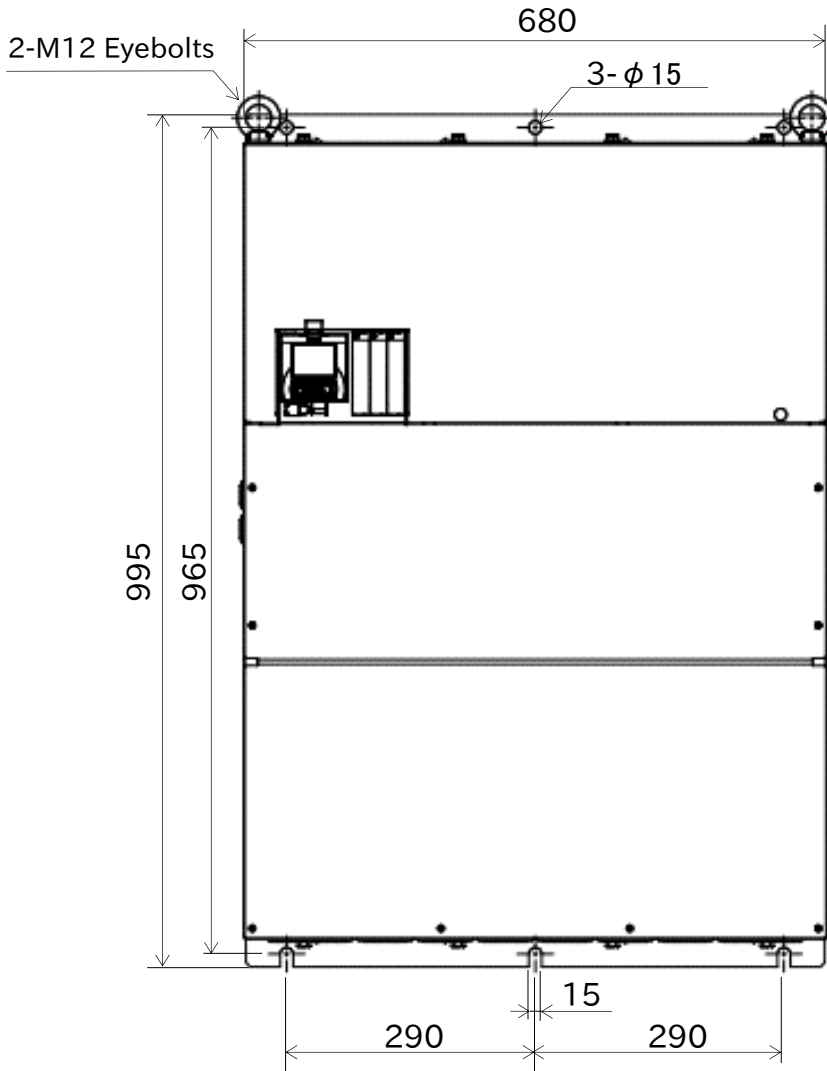

Model P1-*****(P1-****)			
400V class:06600-H(3150H)			
Dimension	W(mm)	H(mm)	D(mm)
	580	1200	450

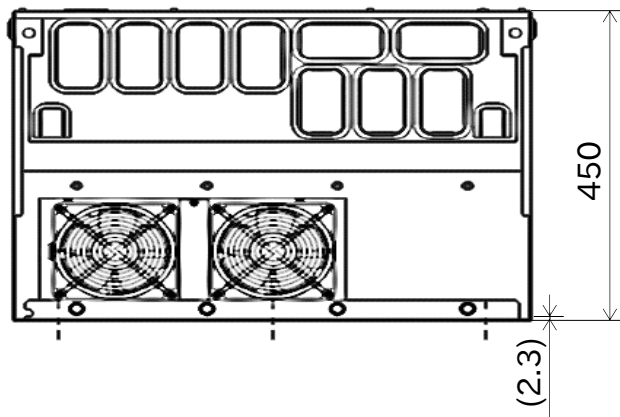
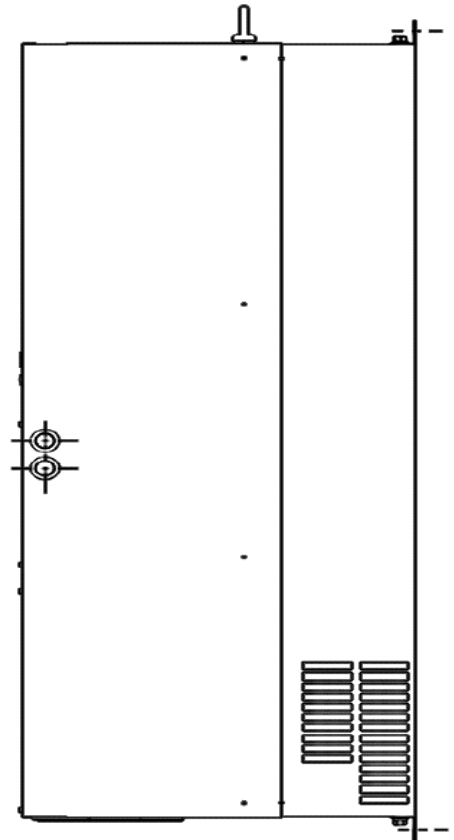
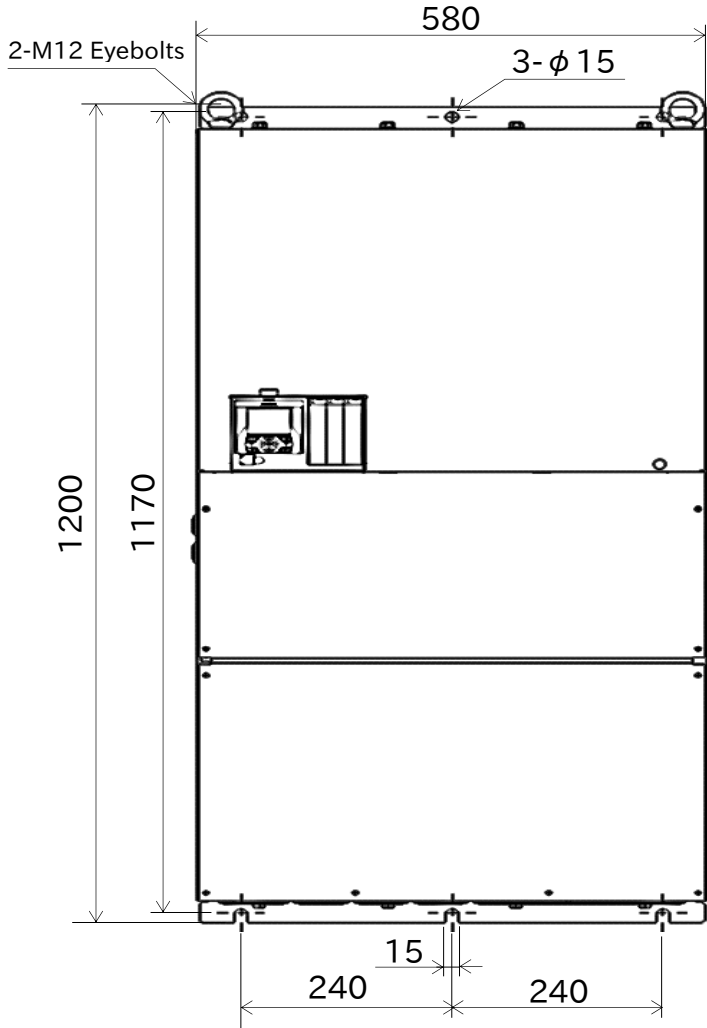

7





Chapter 7 Wire Connection and Optional Devices

Contents

- 7.1 What This Chapter Explains 7-1
- 7.2 Remove the Terminal Block Cover 7-2
- 7.3 Use the Backing Plate 7-3
- 7.4 Check a Terminal Connection Example..... 7-4
- 7.5 Connect Wire to
 - the Main Circuit Terminal Block..... 7-6
 - 7.5.1 Configuration of Main Circuit Terminal Block 7-6
 - 7.5.2 Description of Main Circuit Terminal Block 7-6
 - 7.5.3 What Can Be Done
 - with Main Circuit Terminal Block 7-7
 - 7.5.4 Recommended Wire Diameter,
 - Wiring Tools, and Crimping Terminals..... 7-9
 - 7.5.5 Applicable Breakers.....7-11
 - 7.5.6 Wiring Locations 7-13
 - 7.5.7 Wiring to Power Supply and Motor 7-18
 - 7.5.8 Wiring Separately to
 - the Control Circuit Power Supply..... 7-19
 - 7.5.9 Outline of Applicable Peripheral Devices..... 7-20
 - 7.5.10 DC link choke (DC reactor)
 - Connection Terminal (PD,P) 7-21
 - 7.5.11 Regenerative Braking Option..... 7-22
 - 7.5.12 Inverter Ground Terminal (G)..... 7-23
 - 7.5.13 Enable the Internal EMC Filter..... 7-23
- 7.6 Operation and Optional Areas 7-24
 - 7.6.1 Structure of Operation and Optional Areas 7-24
 - 7.6.2 Description of Operation and Optional Areas .. 7-24
 - 7.6.3 Set Out the Operator Keypad on the Panel 7-25
- 7.7 Control Circuit Terminal Area 7-26
 - 7.7.1 Switch Configuration..... 7-26
 - 7.7.2 Wiring to the Control Circuit Terminal Block..... 7-27
 - 7.7.3 Lower Portion Wiring of the Control Circuit..... 7-29
 - 7.7.4 Upper Portion Wiring of the Control Circuit..... 7-32

7.1 What This Chapter Explains

This chapter describes wiring to the inverter and peripheral options. Before connecting wires with the inverter and installing optional devices, make sure to carefully read “Chapter 1 Safety Instructions/Risks” for safety work.

Symbol	Meanings
	General and troubleshooting questions
	Key points for a solution
	Notes
	Confirmation of procedures

7.2 Remove the Terminal Block Cover

Q

- I want to know the condition of terminal block when the cover is removed.

A

- By removing the cover of the terminal block, you can check the control circuit terminal block. By removing the wiring separation plate and backing plate, you can check the main circuit terminal block.

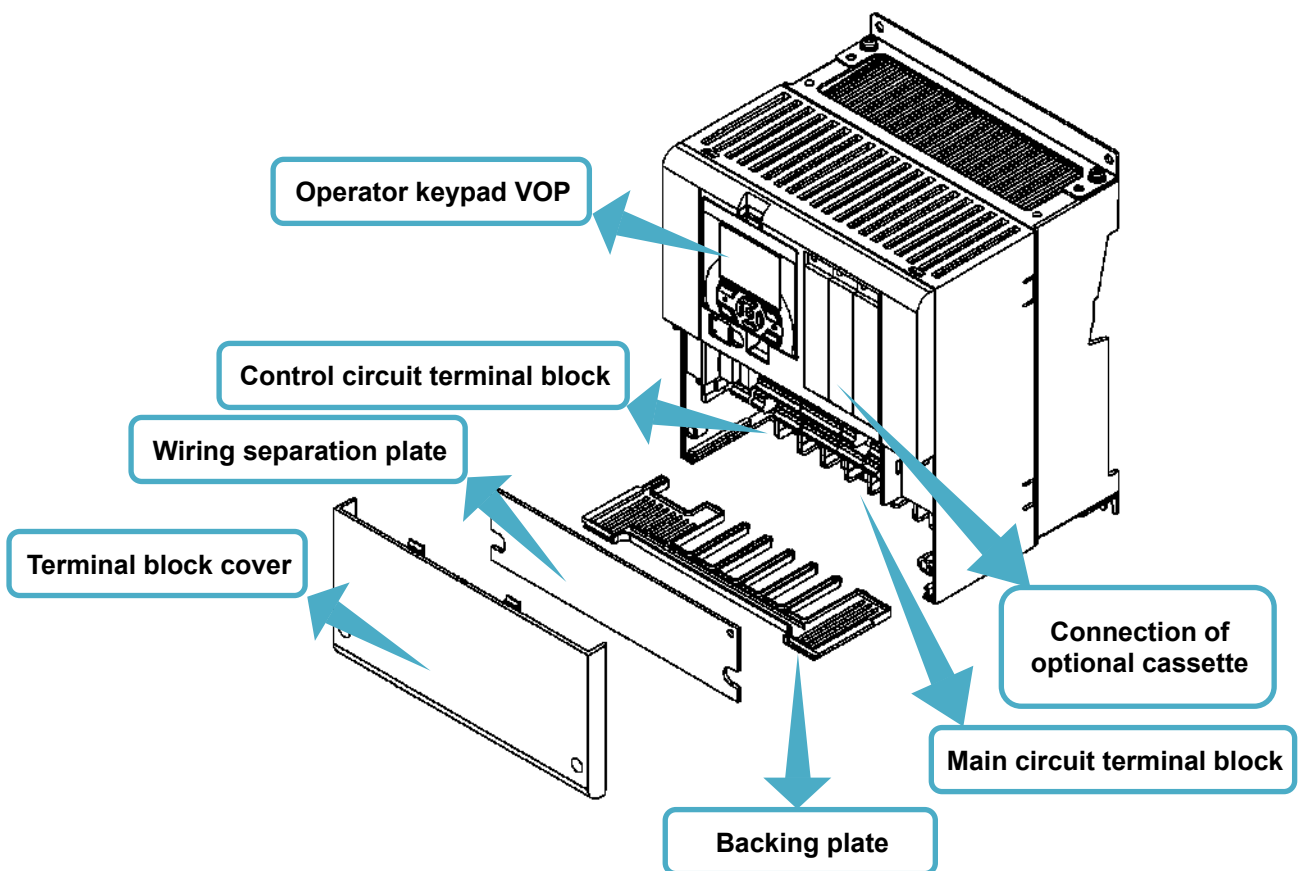

7.3 Use the Backing Plate



- When wiring to apply high voltage to the relay terminals such as AL, draw them out separately from the low voltage wiring of the control circuit.

■ Backing plate (i)

P1-00044-L to P1-00600-L (P1-004L to P1-110L) / P1-00041-H to P1-00310-H (P1-007H to P1-110H)

• Backing plate (i)

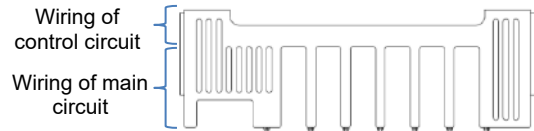

■ Backing plate (ii)

P1-00800-L to P1-01240-L (P1-150L to P1-220L) / P1-00400-H to P1-00620-H (P1-150H to P1-220H)

• Backing plate (ii)

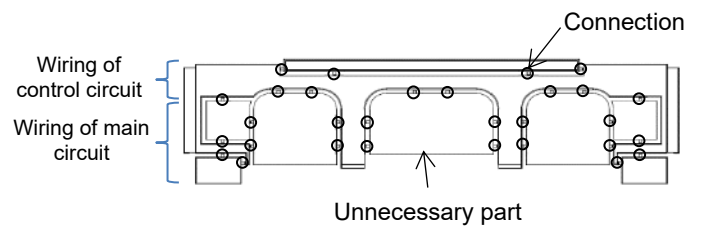

- Cut the connections between the unnecessary part and backing plate using nippers, radio pliers, or cutter, to cut off the unnecessary part for wiring.

■ Backing plate (iii)

P1-01530-L to P1-02950-L (P1-300L to P1-550L) / P1-00770-H to P1-00600-H (P1-300H to P1-3150H)

• Backing plate (iii)

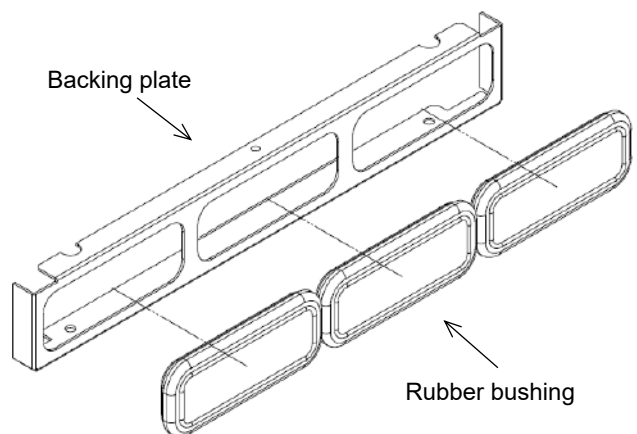

- When a conduit tube is not connected
Cut the rubber bushing to create a notch using nippers or a cutter for wiring.
- When a conduit tube is connected
Remove the rubber bushing in the portion where a conduit tube is to be connected, and then connect the conduit tube.



Electric shock
Ground fault

Do not remove rubber bushings from the wiring section unless a conduit tube is connected. Doing so may cause the edge of backing plate to damage the cable sheath, leading to short circuit or ground fault.

(Note: The drawing of the Backing plate are representative model.
(Refer to “20.3 External Dimensions” for actual shape))

7.4 Check a Terminal Connection Example

* The RB terminal is mounted only on models equipped with the drive circuit for braking resistor.

■ Outline of main circuit

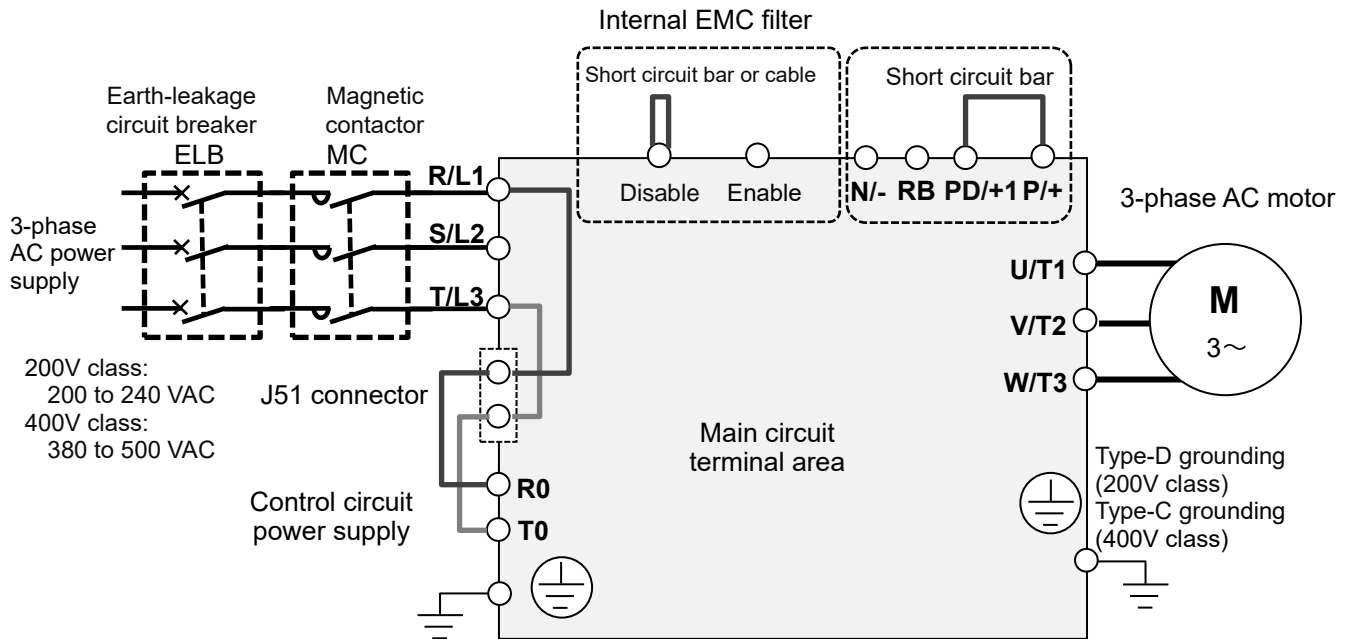

■ Outline of operation section

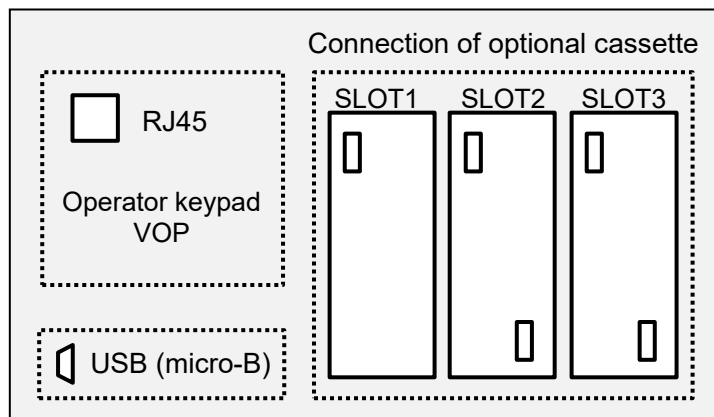

■ Outline of control circuit

* The following shows an example of sink logic

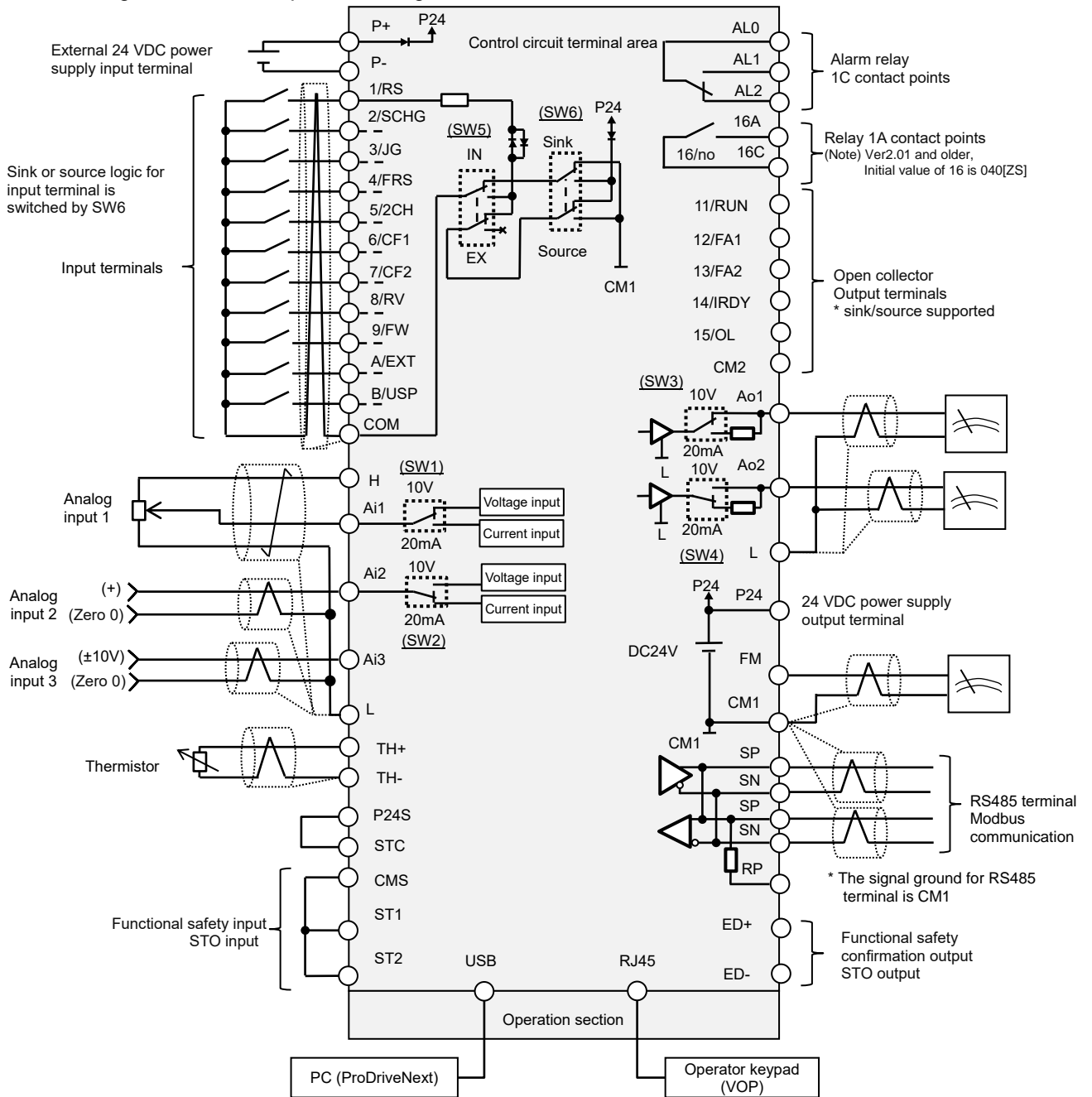

7.5 Connect Wire to the Main Circuit Terminal Block

* The RB terminal is mounted only on models equipped with the drive circuit for braking resistor.

7.5.1 Configuration of Main Circuit Terminal Block

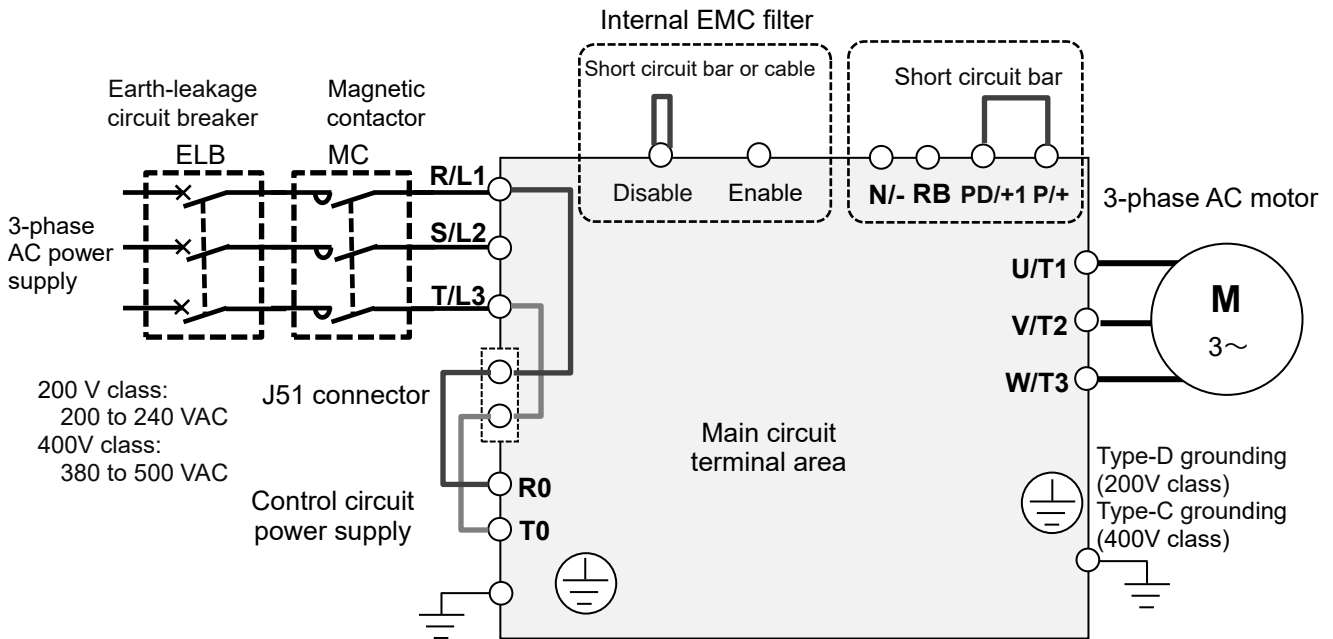

✓ Selection of EMC filter (factory default state)

The EMC filter is disabled:
 Model P1-****-FF and P1-****-FUF
 The EMC filter is enabled:
 Model P1-****-FEF and P1-****-FCF

✓ Short circuit between P and PD (factory default state)

When shipped from the factory, P and PD are short-circuited. If P and PD are not connected, power is not supplied to the main circuit, which disables operation.

7.5.2 Description of Main Circuit Terminal Block

Terminal symbol	Terminal name	Description
R,S,T (L1,L2,L3)	Input terminal for main power supply	Connect to the AC power supply. Leave these terminals unconnected when using a regenerative converter.
U,V,W (T1,T2,T3)	Inverter output terminal	Connect to the 3-phase motor.
PD,P (+1,+)	DC link choke connection terminal	Remove the PD-P jumper from terminals, and connect the optional DC link choke (Ex) HITACHI Model is DCL-***) for power factor improvement.
P,RB (+,RB)	External chopper braking resistor connection terminal	Connect the optional external braking resistor. For models equipped with the braking resistor circuit, see "Chapter 20 Specifications". Models not equipped with the braking resistor circuit does not have the RB terminal.
P,N (+,-)	Regenerative braking unit Connection terminal	Connect the optional regenerative braking unit.
⊕	Inverter ground terminal	This serves as a ground terminal for the inverter chassis to ground. Connect 200V class and 400V class models to Type-D grounding and Type-C grounding, respectively.

7.5.3 What Can Be Done with Main Circuit Terminal Block

■ Points to be noted on main circuit terminals

 **Electric shock**

- Be sure to check that the charge lamp is off before performing wiring. Once the power is turned on, regardless of whether open phase is occurring or the device is running or not, it is very dangerous because the capacitor in the inverter is charged at high voltage for a certain period even after the power is shut off.

 **Do**

- When performing work such as changing wiring after shutting off the power, wait for 10 minutes (*1) or 15 minutes (*2), and check that there is no residual voltage between P and N using a tester or other instrument to confirm safety.

*1)For models P1-00044-L to P1-01240-L (P1-004L to P1-220L) and P1-00041-H to 00620-H (P1-007H to P1-220H)
 *2)For models P1-01530-L to P1-02950-L (P1-300L to P1-550L) and P1-00770-H to P1-06600-H (P1-300H to P1-3150H)

■ Input terminal for main power supply (R,S,T)

 **Do**

- For connection between the power supply and main power terminals (R, S, T), use the earth-leakage breaker for protecting the circuit (wiring).

 **Prohibited**

- This device is compatible with 3-phase power supplies. It cannot be used with single-phase power supplies. If single-phase input is required, please contact our sales office.

 **Do**

- If the protective function of the inverter is activated, it means a failure or an accident is occurring on your system. Connect the magnetic contactor that shuts off power supplied to the inverter.

 **Prohibited**

- Do not operate the inverter when an input phase is lost. Otherwise, you run the risk of damage to the inverter.

 **Do**

- Since the earth-leakage breaker may malfunction due to effects of high frequency, please use a model with large high-frequency sensitive current value.

 **Prohibited**

 **Electric shock Injury Failure**

- The internal capacitor is charged even when an input phase is lost. You run the risk of electric shock and injury.
- When shipped from the factory, the protective function for input phase loss is disabled, and the following conditions are applied.
 - R-phase or T-phase is lacking:
The inverter does not run.
 - S-phase is lacking:
It triggers single phase operation, which may cause insufficient voltage, frequent occurrence of overcurrent errors, and the inverter may be burned.

 **Failure**

 **Prohibited**

- Do not turn on or off the magnetic contactor installed on the input (primary) and output (secondary) sides of the inverter to start or stop operation. Otherwise, you run the risk of damage to the inverter.

 **Do**

- To start or stop operation using an external signal, use the operation command (FW, RV) of the control circuit terminal block.

Input terminal for main power supply (R,S,T) (continued)

 Failure

- Do not use a power supply that is applicable to the following conditions. Otherwise, the internal converter module may be burned.

 Prohibited

- Unbalance of power supply voltage 3% or above.
- The power supply capacity is 10 times or more the appropriate capacity of ND rating motor and it is not less than 500kVA.
- If a rapid change of power supply is made to power.
(Example 1) If more than one inverters are installed and connected with each other by a short bus.
(Example 2) If a phase leading capacitor is inserted or shut off.

 Failure

- Do not turn on and off the power frequently, which should not do more than once every 3 minutes.

 Prohibited

Inverter output terminal (U,V,W)

 DANGER

- Perform wiring only with wires whose thickness is equivalent to or above that of the applicable wires. Otherwise, the output voltage may drop between the inverter and motor. Especially during output at low speed, voltage drop caused by wiring reduces the torque of motor.

 Do

 Failure

- Do not attach a phase leading capacitor or surge absorber, because they may cause inverter errors or damage the capacitor or surge absorber.

 Prohibited

 Failure

- When you connect more than one motors, install a thermal relay for each of them.

 Do

 Burnout

- If the wire length exceeds 20 m, due to stray capacity or inductance of the wire, surge voltage may be generated on the motor terminal (especially on 400V class), which may burn the motor.

 Do

- For suppressing surge voltage filter, please contact your supplier or local Hitachi sales office.

 Failure

- Set the RC value of the thermal relay to be 1.1 times the rated current of motor. The thermal relay may trip earlier than intended depending on the wire length. In such a case, attach an AC reactor on the output side of inverter.

 Do



- For compliance with CE standards and UL standards, check "1.6 Compliance with European Directive (CE)" and "1.7 Compliance with UL Standards".
- If export to the U.S. or Canada or compliance with UL/cUL standards is required, you need to use wires and breakers specified in the UL/cUL standards. When connecting wires to the main circuit terminal block, use a round crimping terminal (UL-certified item) suitable for the wires for use. Use a crimp tool recommended by the manufacturer of the crimping terminal to crimp the terminal.
- The screw size may differ depending on the terminal. For the terminal screw size of the power line, see "7.5.4 Recommended Wire Diameter, Wiring Tools, and Crimping Terminals". For others, see figures in "7.5.6 Wiring Locations".
- For wiring to the inverter, crimping terminal, and tightening torque of terminal screws, see tables in "7.5.4 Recommended Wire Diameter, Wiring Tools, and Crimping Terminals".
- The recommended wire diameter and crimp terminal size vary depending on the settings of load rating (ND/LD/VLD).
- The wire diameters shown in tables in "7.5.4 Recommended Wire Diameter, Wiring Tools, and Crimping Terminals" indicate design values for HIV wire (resistant to 75°C heat).
- When connecting wires to the main circuit terminal block, use a round crimping terminal in accordance with the wires for use. Use a crimp tool recommended by the manufacturer of the crimping terminal to crimp the terminal.
- When replacing SJ700 with this device, for different wire diameter, etc., please contact your supplier or local Hitachi sales office.

7.5.4 Recommended Wire Diameter, Wiring Tools, and Crimping Terminals

■ 200V class

Model P1-*****_* (P1-*****)	Load Type	Power line cable AWG(mm ²) R,S,T,U,V,W, P,PD,N	Grounding cable AWG(mm ²)	External braking resistor between P and RB AWG(mm ²)	Power line cable Terminal screw size	Crimp terminal Power/Ground	Tightening torque(N·m) Power/Ground (maximum value)
P1-00044-L (P1-004L)	ND	14(2.1)	14(2.1)	14(2.1)	M4	2-4/2-4	1.4/1.4 (1.5/1.5)
	LD						
	VLD						
P1-00080-L (P1-007L)	ND	14(2.1)	14(2.1)	14(2.1)	M4	2-4/2-4	1.4/1.4 (1.5/1.5)
	LD						
	VLD						
P1-00104-L (P1-015L)	ND	14(2.1)	14(2.1)	14(2.1)	M4	2-4/2-4	1.4/1.4 (1.5/1.5)
	LD						
	VLD						
P1-00156-L (P1-022L)	ND	14(2.1)	14(2.1)	14(2.1)	M4	2-4/2-4	1.4/1.4 (1.5/1.5)
	LD						
	VLD	10(5.3)	10(5.3)	10(5.3)	5.5-4/5.5-4		
P1-00228-L (P1-037L)	ND	10(5.3)	10(5.3)	10(5.3)	M4	5.5-4/5.5-4	1.4/1.4 (1.5/1.5)
	LD						
	VLD						
P1-00330-L (P1-055L)	ND	8(8.4)	8(8.4)	8(8.4)	M5	8-5/8-5	3.0/3.0 (3.0/3.0)
	LD						
	VLD						
P1-00460-L (P1-075L)	ND	8(8.4)	6(13.3)	8(8.4)	M5	8-5/8-5	3.0/3.0 (3.0/3.0)
	LD						
	VLD	6(13.3)	6(13.3)	14-6/14-6			
P1-00600-L (P1-110L)	ND	6(13.3)	6(13.3)	6(13.3)	M6	14-6/14-6	4.0/4.0 (5.2/5.2)
	LD						
	VLD	4(21.2)	4(21.2)	22-6/14-6			
P1-00800-L (P1-150L)	ND	4(21.2)	6(13.3)	4(21.2)	M6	22-6/14-6	2.5 to 3.0/4.9 (4.1/5.2)
	LD						
	VLD	3(26.7)	3(26.7)	38-6/14-6			
P1-00930-L (P1-185L)	ND	3(26.7)	6(13.3)	3(26.7)	M6	38-6/14-6	2.5 to 3.0/4.9 (4.1/5.2)
	LD						
	VLD	2(33.6)	2(33.6)	60-6/14-6			
P1-01240-L (P1-220L)	ND	1(42.4)	6(13.3)	1(42.4)	M8	60-8/14-6	5.5 to 6.6/4.9 (9.0/5.2)
	LD						
	VLD	1/0(53.5)	1/0(53.5)	70-8/14-6			
P1-01530-L (P1-300L)	ND	2/0(67.4)	4(21.2)	—	M8	70-8/22-8	6.0/11.7 (9.0/12.5)
	LD						
	VLD	1/0×2(53.5×2)	60-8/22-8				
P1-01850-L (P1-370L)	ND	4/0(107.2)	4(21.2)	—	M8	100-8/22-8	15.0/11.7 (15.0/12.5)
	LD						
	VLD	1/0×2(53.5×2)	60-8/22-8	6.0-10.0/11.7 (12.0/12.5)			
P1-02290-L (P1-450L)	ND	1/0×2(53.5×2)	4(21.2)	—	M8	60-8/22-8	6.0 to 10.0/11.7 (12.0/12.5)
	LD						
	VLD	2/0×2(67.4×2)	70-8/22-8				
P1-02950-L (P1-550L)	ND	350kcmil(177)	3(26.7)	—	M10	180-10/38-8	10.0 to 12.0/11.7 (16.5/12.5)
	LD						
	VLD	3/0×2(85.0×2)	80-10/38-8				

◇ The wire size in the above table shows the designed values based on HIV cables (with thermal resistance of 75°C).

◇ When you connect the electric wire with the main circuit terminal block, use the round type crimp terminals (for the UL standard) suitable for the use electric wire. Please put on pressure to the crimp terminals with a crimp tool that the crimp terminal maker recommends.

◇ When applying the UL standard, refer to "1.7 Compliance with UL standards". Tightening torque is recommended "maximum value" in the above table.

■ 400V class

Model P1-****-H (P1-****)	Load Type	Power line cable AWG(mm ²) R,S,T,U,V,W, P,PD,N	Grounding cable AWG(mm ²)	External braking resistor between P and RB AWG(mm ²)	Power line cable Terminal screw size	Crimp terminal Power/Ground	Tightening torque(N·m) Power/Ground (maximum value)
P1-00041-H (P1-007H)	ND/LD/VLD	14(2.1)	14(2.1)	14(2.1)	M4	2-4/2-4	1.4/1.4 (1.5/1.5)
P1-00054-H (P1-015H)	ND/LD/VLD	14(2.1)	14(2.1)	14(2.1)	M4	2-4/2-4	1.4/1.4 (1.5/1.5)
P1-00083-H (P1-022H)	ND/LD/VLD	14(2.1)	14(2.1)	14(2.1)	M4	2-4/2-4	1.4/1.4 (1.5/1.5)
P1-00126-H (P1-037H)	ND/LD	14(2.1)	14(2.1)	14(2.1)	M4	2-4/2-4	1.4/1.4 (1.5/1.5)
	VLD	12(3.3)	12(3.3)	12(3.3)		5.5-4/5.5-4	
P1-00175-H (P1-055H)	ND/LD	12(3.3)	12(3.3)	12(3.3)	M5	5.5-5/5.5-5	3.0/3.0 (3.0/3.0)
	VLD	10(5.3)	10(5.3)	10(5.3)			
P1-00250-H (P1-075H)	ND/LD	10(5.3)	10(5.3)	10(5.3)	M5	5.5-5/5.5-5	3.0/3.0 (3.0/3.0)
	VLD	8(8.4)	8(8.4)	8(8.4)		8-5/8-5	
P1-00310-H (P1-110H)	ND/LD/VLD	8(8.4)	8(8.4)	8(8.4)	M6	8-6/8-6	4.0/4.0 (5.2/5.2)
P1-00400-H (P1-150H)	ND/LD/VLD	8(8.4)	8(8.4)	8(8.4)	M6	8-6/8-6	4.0/4.0 (5.2/5.2)
P1-00470-H (P1-185H)	ND	8(8.4)	8(8.4)	8(8.4)	M6	8-6/8-6	4.0/4.0 (5.2/5.2)
	LD	6(13.3)		6(13.3)		14-6/8-6	
	VLD						
P1-00620-H (P1-220H)	ND	6(13.3)	8(8.4)	6(13.3)	M6	14-6/8-6	4.0/4.0 (5.2/5.2)
	LD	4(21.2)		4(21.2)		22-6/8-6	
	VLD						
P1-00770-H (P1-300H)	ND	3(26.7)	6(13.3)	3(26.7)	M6	38-6/14-6	2.5 to 3.0/4.9 (4.1/5.2)
	LD	2(33.6)		2(33.6)		60-6/14-6	
	VLD	1(42.4)		1(42.4)			
P1-00930-H (P1-370H)	ND/LD/VLD	1(42.4)	6(13.3)	1(42.4)	M8	60-8/14-8	15.0/11.7 (15.0/12.5)
P1-01160-H (P1-450H)	ND	1(42.4)	6(13.3)	-	M8	60-8/14-8	15.0/11.7 (15.0/12.5)
	LD	1/0(53.5)		-			
	VLD						
P1-01470-H (P1-550H)	ND	1/0(53.5)	4(21.2)	-	M8	60-8/22-8	15.0/11.7 (15.0/12.5)
	LD	2/0(67.4)		70-8/22-8			
	VLD	1/0×2(53.5×2)		60-8/22-8		6.0 to 10.0/11.7 (12.0/12.5)	
P1-01760-H (P1-750H)	ND/LD/VLD	1/0×2(53.5×2)	4(21.2)	-	M10	60-10/22-8	10.0 to 12.0/11.7 (16.5/12.5)
P1-02130-H (P1-900H)	ND/LD	1/0×2(53.5×2)	3(26.7)	-	M10	60-10/38-8	10.0 to 12.0/11.7 (16.5/12.5)
	VLD	2/0×2(67.4×2)					
P1-02520-H (P1-1100H)	ND/LD	2/0×2(67.4×2)	1(42.4)	-	M10	70-10/60-8	10.0 to 12.0/11.7 (16.5/12.5)
	VLD	3/0×2(85.0×2)		80-10/60-8			
	ND	3/0×2(85.0×2)		80-10/60-8			
P1-03160-H (P1-1320H)	LD	4/0×2(107×2)	1(42.4)	-	M10	100-10/60-8	10.0 to 12.0/11.7 (16.5/12.5)
	VLD	250kcmil×2 (127×2)		150-10/60-8			
	ND	3/0×2(85.0×2)		80-12/70-12			
P1-03720-H (P1-1600H)	LD	4/0×2(107×2)	2/0(67.4)	-	M12	150-12/70-12	15.5 to 18.5/39.6 (25.5/42.0)
	VLD	250kcmil×2 (127×2)		150-12/70-12			
	ND	250kcmil×2 (127×2)		150-12/70-12			
P1-04320-H (P1-1850H)	LD	250kcmil×2 (127×2)	2/0(67.4)	-	M12	150-12/70-12	15.5 to 18.5/39.6 (25.5/42.0)
	VLD	300kcmil×2 (152×2)		150-12/70-12			
	ND	250kcmil×2 (127×2)		150-L16/70-12			
P1-04860-H (P1-2000H)	LD	300kcmil×2 (152×2)	2/0(67.4)	-	M16	150-L16/70-12	37.0/39.6 (55.5/42.0)
	VLD	350kcmil×2 (177×2)		180-L16/70-12			
	ND	250kcmil×2 (127×2)		150-L16/70-12			
P1-05200-H (P1-2200H)	LD	350kcmil×2 (177×2)	2/0(67.4)	-	M16	180-L16/70-12	37.0/39.6 (55.5/42.0)
	VLD	400kcmil×2 (203×2)		200-L16/70-12			
	ND	300kcmil×2 (152×2)		150-L16/70-12			
P1-05500-H (P1-2500H)	LD	500kcmil×2 (253×2)	2/0(67.4)	-	M16	200-L16/70-12	37.0/39.6 (55.5/42.0)
	ND	400kcmil×2 (203×2)		325-L16/70-12			
P1-06600-H (P1-3150H)	LD	600kcmil×2 (304×2)	4/0(107)	-	M16	325-L16/100-12	37.0/39.6 (55.5/42.0)
	ND	500kcmil×2 (253×2)		325-L16/100-12			

◇ The wire size in the above table shows the designed values based on HIV cable (with thermal resistance of 75°C).

◇ When applying the UL standard, refer to "1.7 Compliance with UL Standards". Tightening torque is recommended "maximum value" in the above table.

◇ When you connect the electric wire with the main circuit terminal block, use the round type crimp terminals (for the UL standard) suitable for the use electric wire. Please put on pressure to the crimp terminals with a crimp tool that the crimp terminal maker recommends.

7.5.5 Applicable Breakers

- 200V class
- For ND rating

Model P1-*****_* (P1-****)	Applicable Motor (kW)	Applicable devices (Input Voltage 200 to 220 V)							
		Without reactor (DCL or ALI)				With reactor (DCL or ALI)			
		Earth-leakage breaker (ELB)		Input side Magnetic Contactor (MC)		Earth-leakage breaker (ELB)		Input side Magnetic Contactor (MC)	
		Example model	Current Rate (A)	AC-1	AC-3	Example model	Current Rate (A)	AC-1	AC-3
P1-00044-L(P1-004L)	0.4	EB-30E	5	HS8	HS8	EB-30E	5	HS8	HS8
P1-00080-L(P1-007L)	0.75	EB-30E	10	HS8	HS8	EB-30E	5	HS8	HS8
P1-00104-L(P1-015L)	1.5	EB-30E	15	HS8	HS8	EB-30E	10	HS8	HS8
P1-00156-L(P1-022L)	2.2	EB-30E	20	HS8	HS8	EB-30E	15	HS8	HS8
P1-00228-L(P1-037L)	3.7	EB-30E	30	HS8	HS20	EB-30E	20	HS8	HS20
P1-00330-L(P1-055L)	5.5	EB-50E	40	HS20	HS25	EB-30E	30	HS8	HS20
P1-00460-L(P1-075L)	7.5	EB-50E	50	HS35	HS35	EB-50E	40	HS20	HS25
P1-00600-L(P1-110L)	11	EB-100E	75	HS50	H65C	EB-100E	60	HS35	HS50
P1-00800-L(P1-150L)	15	EXK125-C	125	H65C	H80C	EB-100E	100	HS50	H65C
P1-00930-L(P1-185L)	18.5	EXK125-C	125	H80C	H100C	EB-100E	100	HS50	H65C
P1-01240-L(P1-220L)	22	EXK225	150	H80C	H125C	EXK125-C	125	H65C	H80C
P1-01530-L(P1-300L)	30	EXK225	200	H125C	H150C	EXK225	150	H80C	H125C
P1-01850-L(P1-370L)	37	RXK250-S	250	H150C	H200C	EXK225	200	H100C	H125C
P1-02290-L(P1-450L)	45	EX400	300	H200C	H250C	EXK225	225	H125C	H150C
P1-02950-L(P1-550L)	55	EX400	400	H200C	H300C	EX400	300	H150C	H250C

- For LD/VLD rating

Model P1-*****_* (P1-****)	Applicable Motor (kW)	Applicable devices(Input Voltage 200 to 220 V)							
		Without reactor (DCL or ALI)				With reactor (DCL or ALI)			
		Earth-leakage breaker (ELB)		Input side Magnetic Contactor (MC)		Earth-leakage breaker (ELB)		Input side Magnetic Contactor (MC)	
		Example model	Current Rate (A)	AC-1	AC-3	Example model	Current Rate (A)	AC-1	AC-3
P1-00044-L(P1-004L)	0.75	EB-30E	10	HS8	HS8	EB-30E	5	HS8	HS8
P1-00080-L(P1-007L)	1.5	EB-30E	15	HS8	HS8	EB-30E	10	HS8	HS8
P1-00104-L(P1-015L)	2.2	EB-30E	20	HS8	HS8	EB-30E	15	HS8	HS8
P1-00156-L(P1-022L)	3.7	EB-30E	30	HS8	HS20	EB-30E	20	HS8	HS20
P1-00228-L(P1-037L)	5.5	EB-50E	40	HS20	HS25	EB-30E	30	HS8	HS20
P1-00330-L(P1-055L)	7.5	EB-50E	50	HS35	HS35	EB-50E	40	HS20	HS25
P1-00460-L(P1-075L)	11	EB-100E	75	HS50	H65C	EB-100E	60	HS35	HS50
P1-00600-L(P1-110L)	15	EXK125-C	125	H65C	H80C	EB-100E	100	HS50	H65C
P1-00800-L(P1-150L)	18.5	EXK125-C	125	H80C	H100C	EB-100E	100	HS50	H65C
P1-00930-L(P1-185L)	22	EXK225	150	H80C	H125C	EXK125-C	125	H65C	H80C
P1-01240-L(P1-220L)	30	EXK225	200	H125C	H150C	EXK225	150	H80C	H125C
P1-01530-L(P1-300L)	37	RXK250-S	250	H150C	H200C	EXK225	200	H100C	H125C
P1-01850-L(P1-370L)	45	EX400	300	H200C	H250C	EXK225	225	H125C	H150C
P1-02290-L(P1-450L)	55	EX400	400	H200C	H300C	EX400	300	H150C	H250C
P1-02950-L(P1-550L)	75	EX600B	500	H300C	H400C	EX400	400	H200C	H300C

(Note)

- *1) If export to the U.S. or Canada or compliance with UL/cUL standards is required, wires and breakers described in UL/cUL should be used. For details, see "1.7 Compliance with UL Standards".
- *2) Device model name on above table shows example selection. The device selection should be made in base on rated current, short circuit current capability and accordance to the local electrical legislation.
- *3) Refer to the wire gauge table on " 7.5.4 Recommended Wire Diameter, Wiring Tools, and Crimping Terminals".
- *4) The electrical endurance of the class AC-1 magnetic contactor is 500,000 times, but when using for emergency stops during motor drive, the electrical endurance is 25 times.
- *5) If using a MC for emergency stop during motor drive, select a MC of the class AC-3 rated current depending on the inverter input current. And if using a MC on the motor side for switch to commercial power supply, select a MC of the class AC-3 rated current depending on the motor rated current.
- *6) When selecting oversize inverter capacity compare to motor rating, select magnetic contactor according to the inverter capacity.
- *7) Applicable motor capacity is based on Hitachi 200 VAC, 60Hz, 4 pole IE3 motor.

■ 400V class

• For ND rating

Model P1-****_* (P1-****)	Applicable Motor (kW)	Applicable devices (Input Voltage 400 to 440V)							
		Without reactor (DCL or ALI)				With reactor (DCL or ALI)			
		Earth-leakage breaker (ELB)		Input side Magnetic Contactor (MC)		Earth-leakage breaker (ELB)		Input side Magnetic Contactor (MC)	
		Example model	Rated current (A)	AC-1	AC-3	Example model	Rated current (A)	AC-1	AC-3
P1-00041-H(P1-007H)	0.75	EXK60-C	15	HS8	HS8	EXK60-C	15	HS8	HS8
P1-00054-H(P1-015H)	1.5	EXK60-C	15	HS8	HS8	EXK60-C	15	HS8	HS8
P1-00083-H(P1-022H)	2.2	EXK60-C	15	HS8	HS8	EXK60-C	15	HS8	HS8
P1-00126-H(P1-037H)	3.7	EXK60-C	15	HS8	HS10	EXK60-C	15	HS8	HS10
P1-00175-H(P1-055H)	5.5	EXK60-C	20	HS8	HS20	EXK60-C	15	HS8	HS20
P1-00250-H(P1-075H)	7.5	EXK60-C	30	HS8	HS25	EXK60-C	20	HS8	HS25
P1-00310-H(P1-110H)	11	EXK60-C	40	HS20	HS35	EXK60-C	30	HS20	HS35
P1-00400-H(P1-150H)	15	EXK60-C	50	HS25	HS50	EXK60-C	40	HS20	HS35
P1-00470-H(P1-185H)	18.5	EXK125-C	75	HS35	HS50	EXK60-C	50	HS35	HS50
P1-00620-H(P1-220H)	22	EXK125-C	75	HS50	H65C	EXK60-C	60	HS50	H65C
P1-00770-H(P1-300H)	30	EXK125-C	100	HS50	H80C	EXK125-C	75	HS50	H65C
P1-00930-H(P1-370H)	37	EXK125-C	125	H80C	H100C	EXK125-C	100	H65C	H80C
P1-01160-H(P1-450H)	45	EXK225	150	H80C	H125C	EXK125-C	125	H80C	H100C
P1-01470-H(P1-550H)	55	EXK225	200	H100C	H125C	EXK225	150	H100C	H125C
P1-01760-H(P1-750H)	75	RXK250-S	250	H150C	H200C	EXK225	200	H125C	H150C
P1-02130-H(P1-900H)	90	EX400	300	H200C	H250C	EXK225	225	H150C	H250C
P1-02520-H(P1-1100H)	110	EX400	400	H200C	H300C	EX400	300	H200C	H250C
P1-03160-H(P1-1320H)	132	EX600B	500	H250C	H300C	EX400	350	H250C	H300C
P1-03720-H(P1-1600H)	160					RX400B	400	H400C	H400C
P1-04320-H(P1-1850H)	185					RX600B	500	H400C	H600C
P1-04860-H(P1-2000H)	200					RX600B	500	H600C	H600C
P1-05200-H(P1-2200H)	220					RX600B	500	H600C	H600C
P1-05500-H(P1-2500H)	250					RX600B	600	H600C	H600C
P1-06600-H(P1-3150H)	315					RX800B	700	H800C	H800C

• For LD/VLD rating

Model P1-****_* (P1-****)	Applicable Motor (kW)	Applicable devices (Input Voltage 400 to 440V)							
		Without reactor (DCL or ALI)				With reactor (DCL or ALI)			
		Earth-leakage breaker (ELB)		Input side Magnetic Contactor (MC)		Earth-leakage breaker (ELB)		Input side Magnetic Contactor (MC)	
		Example model	Rated current (A)	AC-1	AC-3	Example model	Rated current (A)	AC-1	AC-3
P1-00041-H(P1-007H)	1.5	EXK60-C	15	HS8	HS8	EXK60-C	15	HS8	HS8
P1-00054-H(P1-015H)	2.2	EXK60-C	15	HS8	HS8	EXK60-C	15	HS8	HS8
P1-00083-H(P1-022H)	3.7	EXK60-C	15	HS8	HS10	EXK60-C	15	HS8	HS8
P1-00126-H(P1-037H)	5.5	EXK60-C	20	HS8	HS20	EXK60-C	15	HS8	HS20
P1-00175-H(P1-055H)	7.5	EXK60-C	30	HS8	HS25	EXK60-C	20	HS8	HS20
P1-00250-H(P1-075H)	11	EXK60-C	40	HS20	HS35	EXK60-C	30	HS20	HS25
P1-00310-H(P1-110H)	15	EXK60-C	50	HS25	HS50	EXK60-C	40	HS25	HS35
P1-00400-H(P1-150H)	18.5	EXK125-C	75	HS35	HS50	EXK60-C	50	HS35	HS50
P1-00470-H(P1-185H)	22	EXK125-C	75	HS50	H65C	EXK60-C	60	HS50	HS50
P1-00620-H(P1-220H)	30	EXK125-C	100	HS50	H80C	EXK125-C	75	HS50	H65C
P1-00770-H(P1-300H)	37	EXK125-C	125	H80C	H100C	EXK125-C	100	H80C	H80C
P1-00930-H(P1-370H)	45	EXK225	150	H80C	H125C	EXK125-C	125	H80C	H100C
P1-01160-H(P1-450H)	55	EXK225	200	H100C	H125C	EXK225	150	H100C	H125C
P1-01470-H(P1-550H)	75	EX400	250	H150C	H200C	EXK225	200	H150C	H200C
P1-01760-H(P1-750H)	90	EX400	300	H200C	H250C	EXK225	225	H200C	H200C
P1-02130-H(P1-900H)	110	EX400	400	H200C	H300C	EX400	300	H200C	H250C
P1-02520-H(P1-1100H)	132	EX600B	500	H250C	H300C	EX400	350	H250C	H300C
P1-03160-H(P1-1320H)	160	EX600B	600	H400C	H400C	EX400	400	H400C	H400C
P1-03720-H(P1-1600H)	185					RX600B	500	H400C	H600C
P1-04320-H(P1-1850H)	200					RX600B	500	H600C	H600C
P1-04860-H(P1-2000H)	220					RX600B	500	H600C	H600C
P1-05200-H(P1-2200H)	250					RX600B	600	H600C	H600C
P1-05500-H(P1-2500H)	280					RX600B	600	H600C	H600C
P1-06600-H(P1-3150H)	355					RX800B	700	H800C	H800C

*1) Same as notes *1) to *6) for 200V class. See the previous page.

*2) Applicable motor capacity is based on Hitachi 400 VAC, 60Hz, 4 pole IE3 motor.

7.5.6 Wiring Locations

DANGER

- The charge lamp indicates input of power to R, S, and T. At the factory default setting, power is supplied to R0 and T0 via the J51 connector.
- When the J51 connector is removed and power is supplied to R0 and T0 from another source, the charge lamp does not indicate energization status of R0 and T0. Make sure that the power is shut off and safety is ensured before working.
- The charge lamp does not light up also when only 24V is supplied.

Model P1-***(P1-****)**

200V class: 00044-L(004L), 00080-L(007L), 00104-L(015L), 00156-L(022L), 00228-L(037L)

400V class: 00041-H(007H), 00054-H(015H), 00083-H(022H), 00126-H(037H)

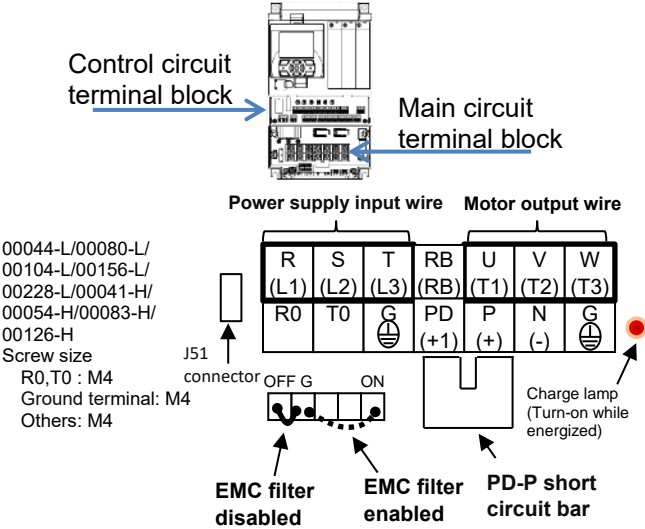

*As shown in the figure above, the EMC filter switches enable / disable by replacing the short circuit cable to the connector.

Model P1-***(P1-****)**

200V class: 00330-L(055L), 00460-L(075L), 00600-L(110L)

400V class: 00175-H(055H), 00250-H(075H), 00310-H(110H)

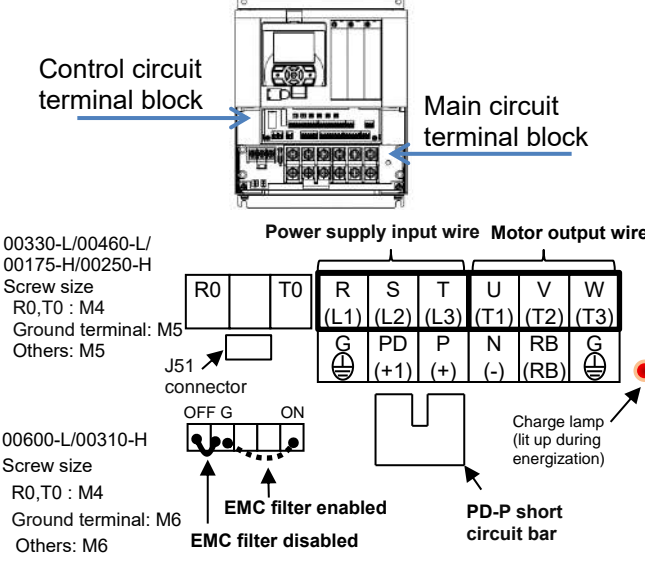

*As shown in the figure above, the EMC filter switches enable / disable by replacing the short circuit cable to the connector.

Model P1-***(P1-****)**

200V class: 00800-L(150L), 00930-L(185L), 01240-L(220L)

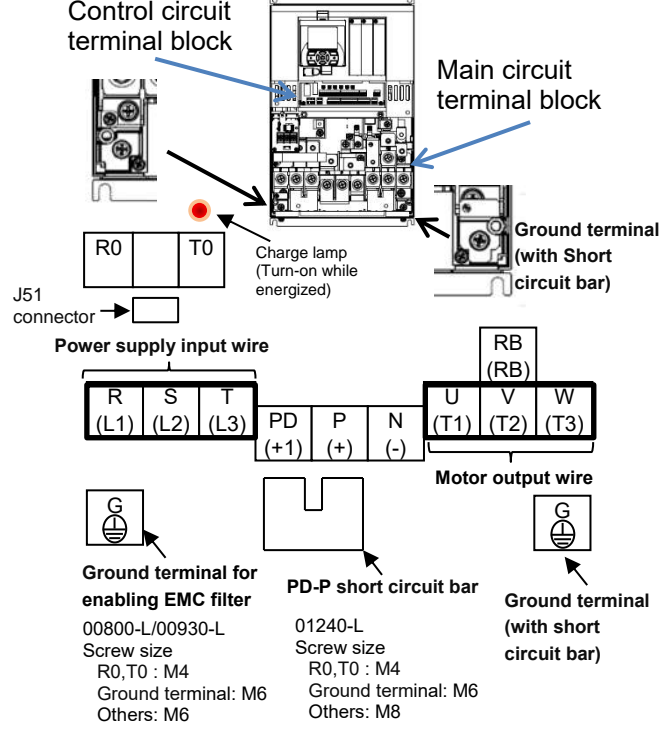

* To enable the EMC filter, fix the grounding screw equipped with short circuit bar to the ground terminal for enabling the EMC filter.

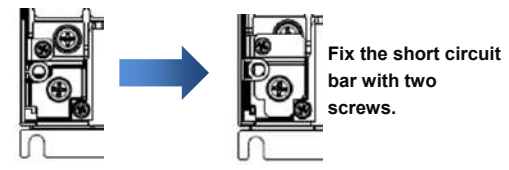

Model P1-***(P1-****)**

400V class: 00400-H(150H), 00470-H(185H), 00620-H(220H)

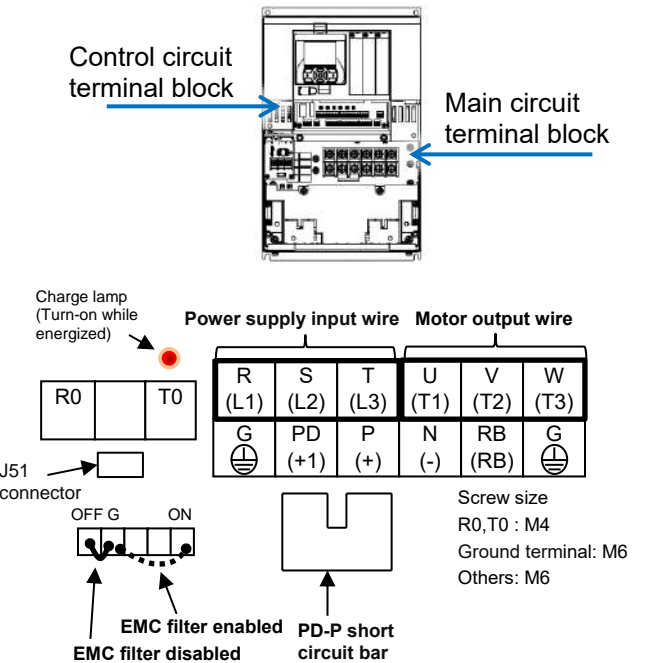

*As shown in the figure above, the EMC filter switches enable / disable by replacing the short circuit cable to the connector.

Model P1-***(P1-****)**
 200V class: 01530-L(300L)

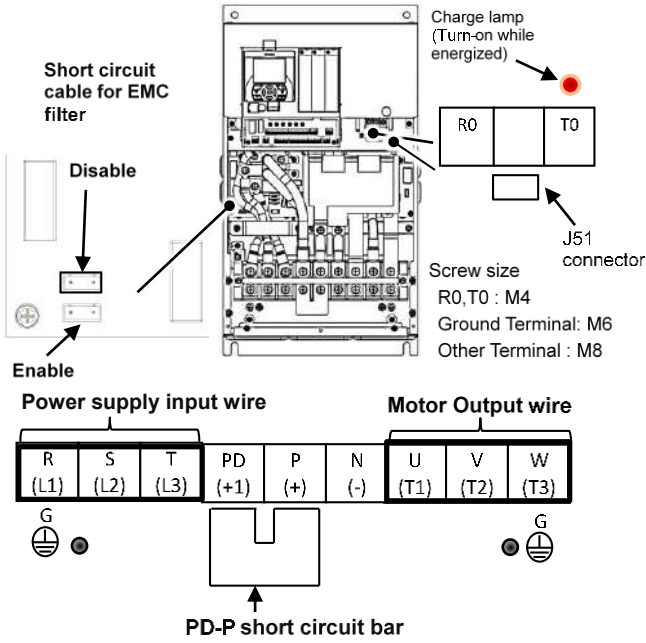

◇ Switch the short circuit cable to enable / disable the EMC filter.

Model P1-***(P1-****)**
 200V class: 01850-L(370L), 02290-L(450L)

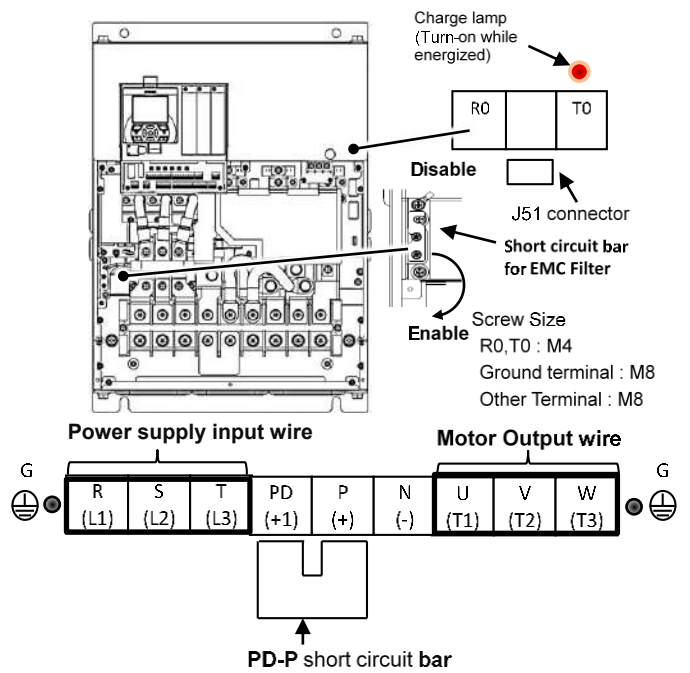

◇ Switch the short circuit bar to enable or disable the EMC filter as shown below.

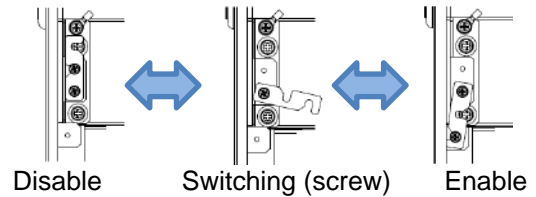

Model P1-***(P1-****)**
 400V class: 00770-H(300H)

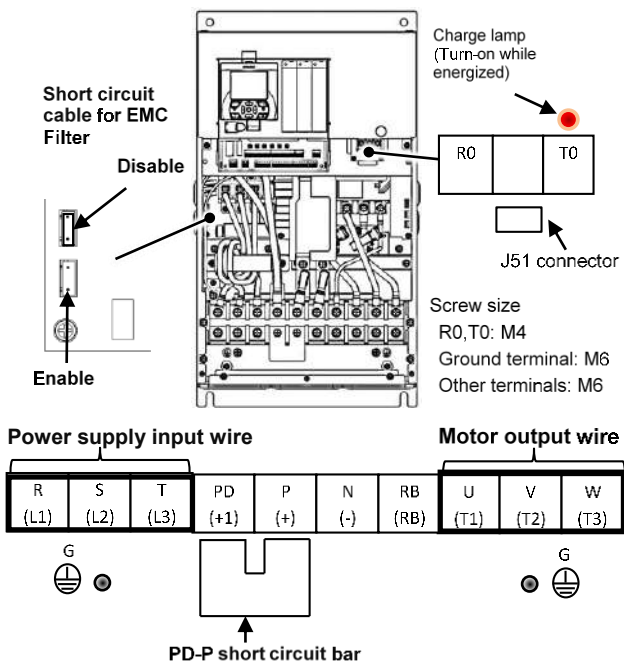

* Switch the short circuit cable to enable / disable the EMC filter.

Model P1-***(P1-****)**
 400V class: 00930-H(370H)

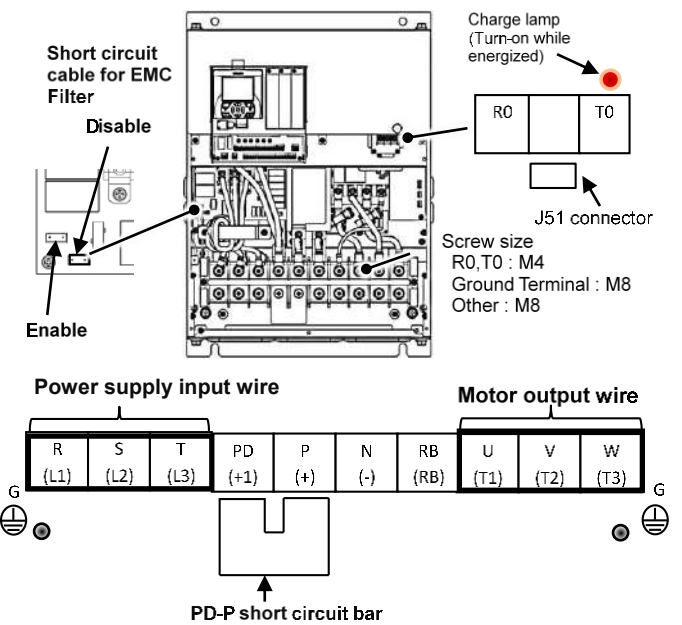

* Switch the short circuit cable to enable / disable the EMC filter.

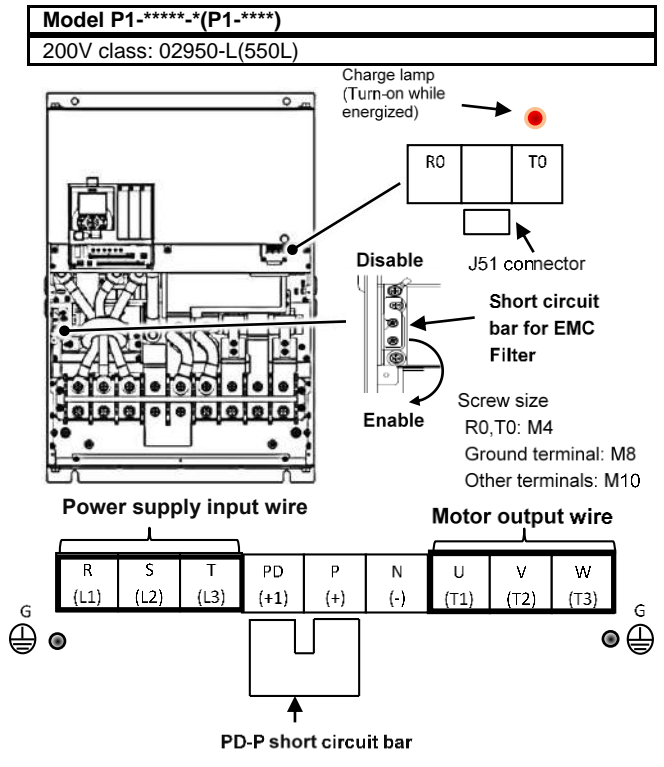
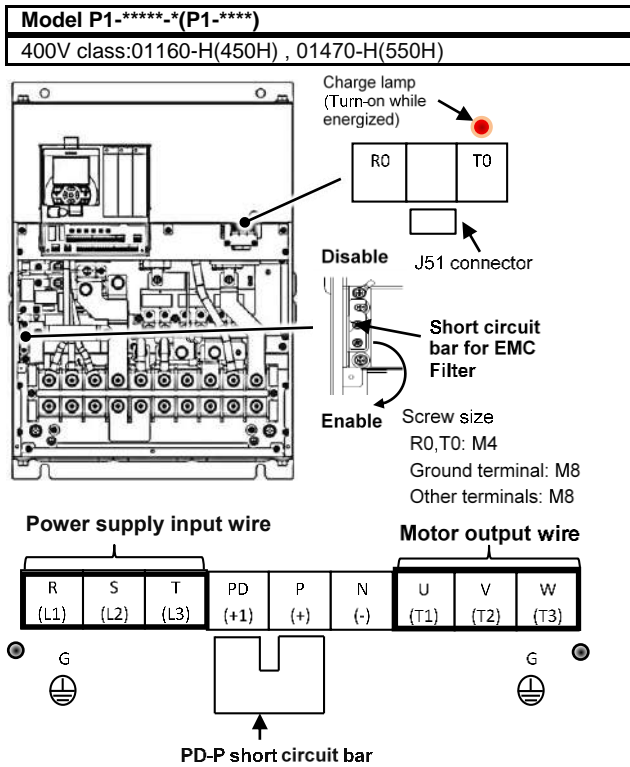

* For the switching method of EMC filter, see the lower section of this page

* For the switching method of EMC filter, see the lower left section of this page.

• Switching method of EMC filter

The EMC filter is enabled / disabled by switching the short circuit bar.

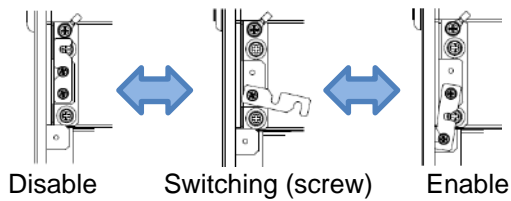

Model P1-***(P1-*****)**
 400V class:01760-H(750H), 02130-H(900H)

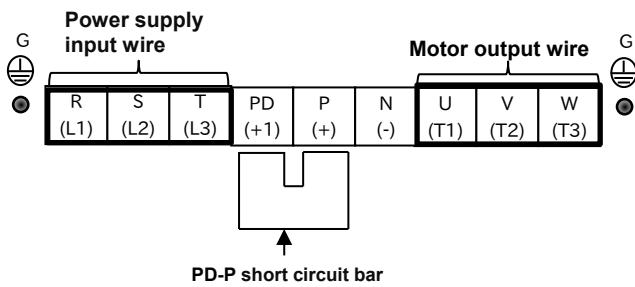
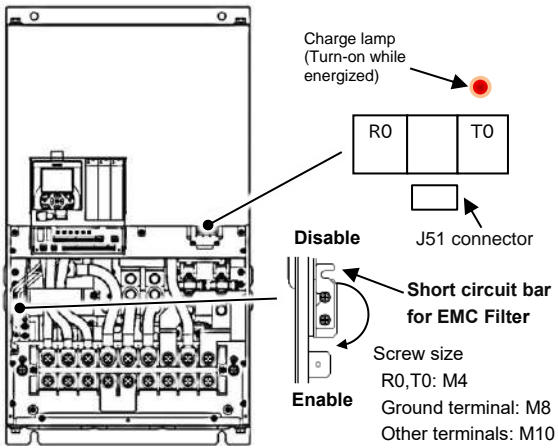

* For the switching method of EMC filter, see the lower section of this page

Model P1-***(P1-*****)**
 400V class:02520-H(1100H), 03160-H(1320H)

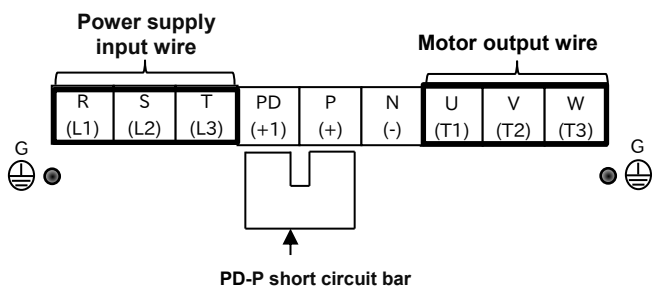
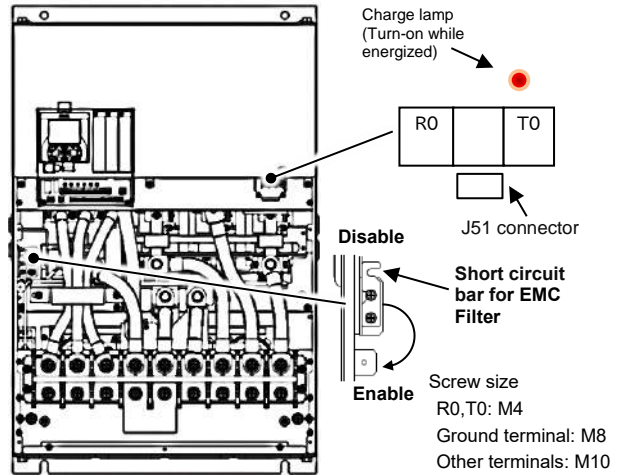

* For the switching method of EMC filter, see the lower left section of this page.

Model P1-***(P1-*****)**
 400V class: 03720-H(1600H)

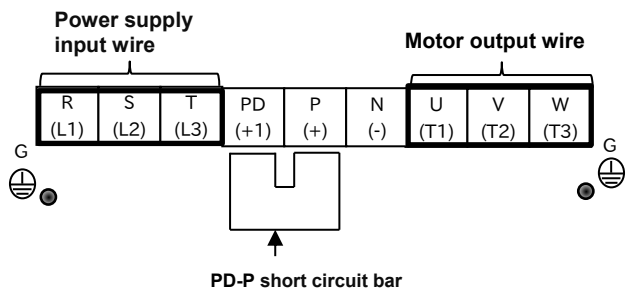
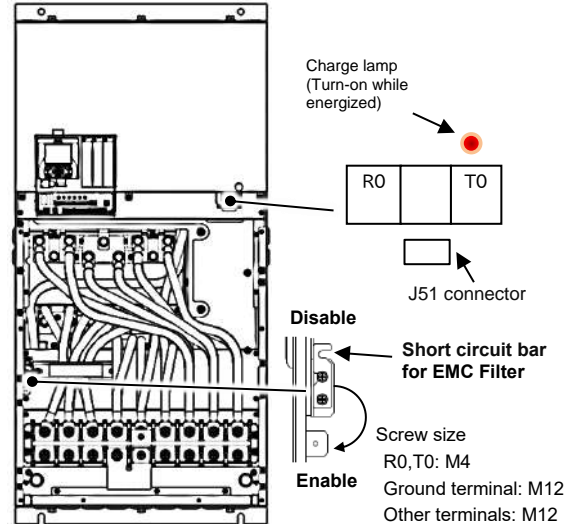

* For the switching method of EMC filter, see the left section of this page.

· Switching method of EMC filter
 The EMC filter is enabled / disabled by switching the short circuit bar.

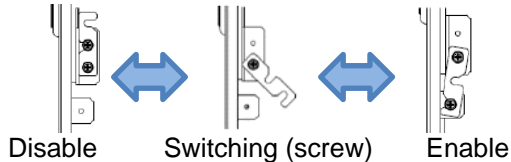

Model P1- ****(P1-*****)**
 400V class: 04320-H(1850H)

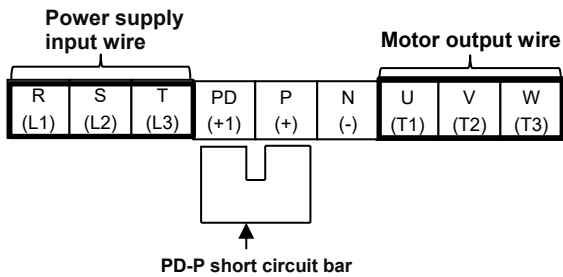
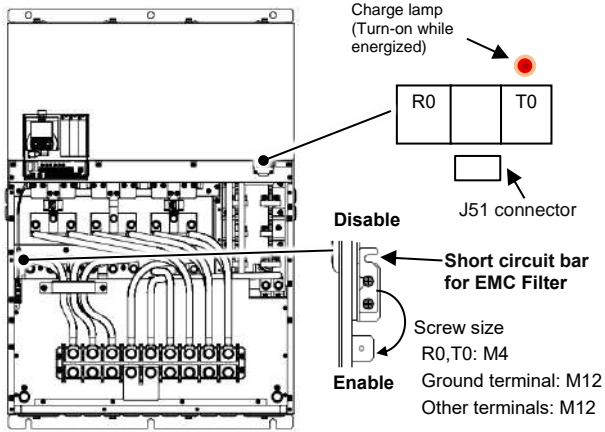

* For the switching method of EMC filter, see the lower section of this page.

Model P1- ****(P1-*****)**
 400V class: 04860-H(2000H), 05200-H(2200H), 06600-H(3250H)

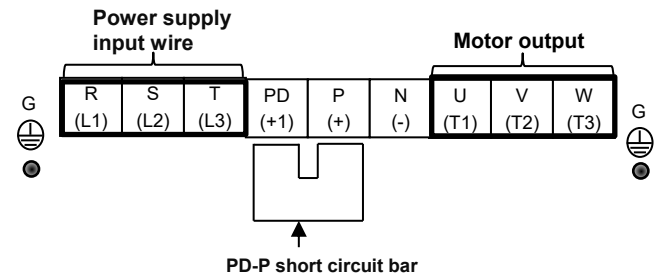
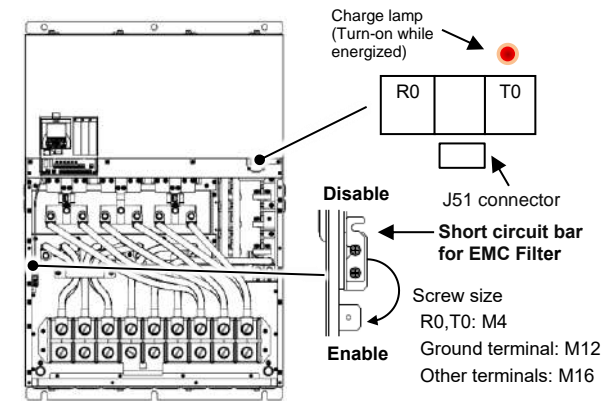

* For the switching method of EMC filter, see the lower left section of this page.

Model P1- ****(P1-*****)**
 400V class: 06600-H(3150H)

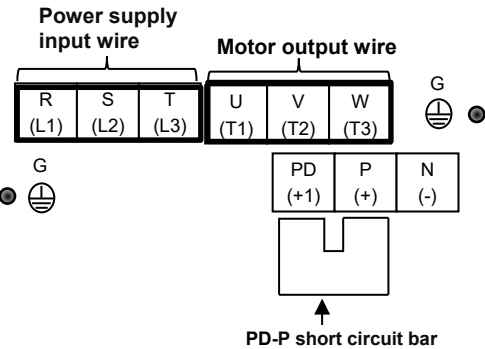
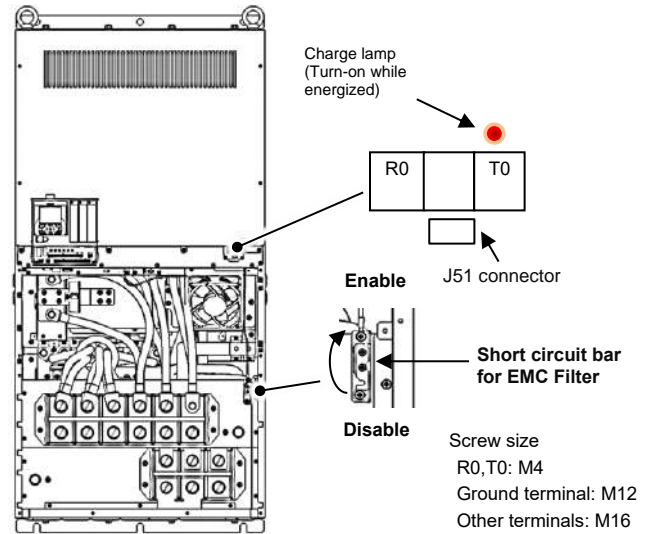

◇ Switching method of EMC filter
 Switch the short circuit bar to enable / disable the EMC filter.

■ P1-04320-H(P1-1850H) to P1-05500-H(P1-2500H)

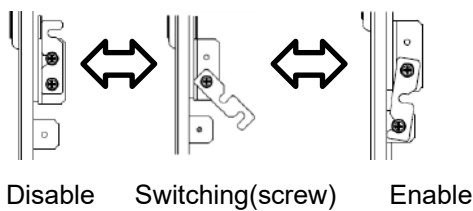

■ P1-06600-H(P1-3150H)

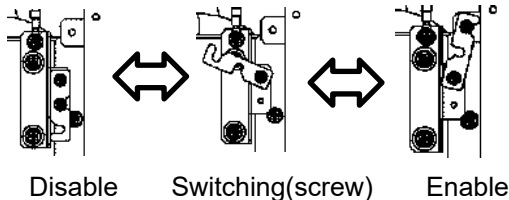

◇ For the switching method of EMC filter, see the left side of this page.

◇ For models without description, please contact your supplier or local Hitachi inverter sales office.

7.5.7 Wiring to Power Supply and Motor

Q

- I want to connect a power supply to the inverter.
- I want to connect a motor to the inverter.

A

- Connect R, S, T (L1, L2, L3) to the AC power supply.
- Connect U, V, W (T1, T2, T3) to the motor.
- The common wiring examples are shown below.



Do · Use the input power supply within the range shown below.

Voltage class	Input range
200 V class	200 to 240 VAC (allowable variation range: +10% / -15%) Power supply frequency: 50 Hz / 60 Hz (variation range: ± 5%)
400 V class	380 to 500 VAC (allowable variation range: +10% / -15%) Power supply frequency: 50 Hz / 60 Hz (variation range: ± 5%)



· Driving a 200 V class motor using a 400 V class inverter may burn the motor.

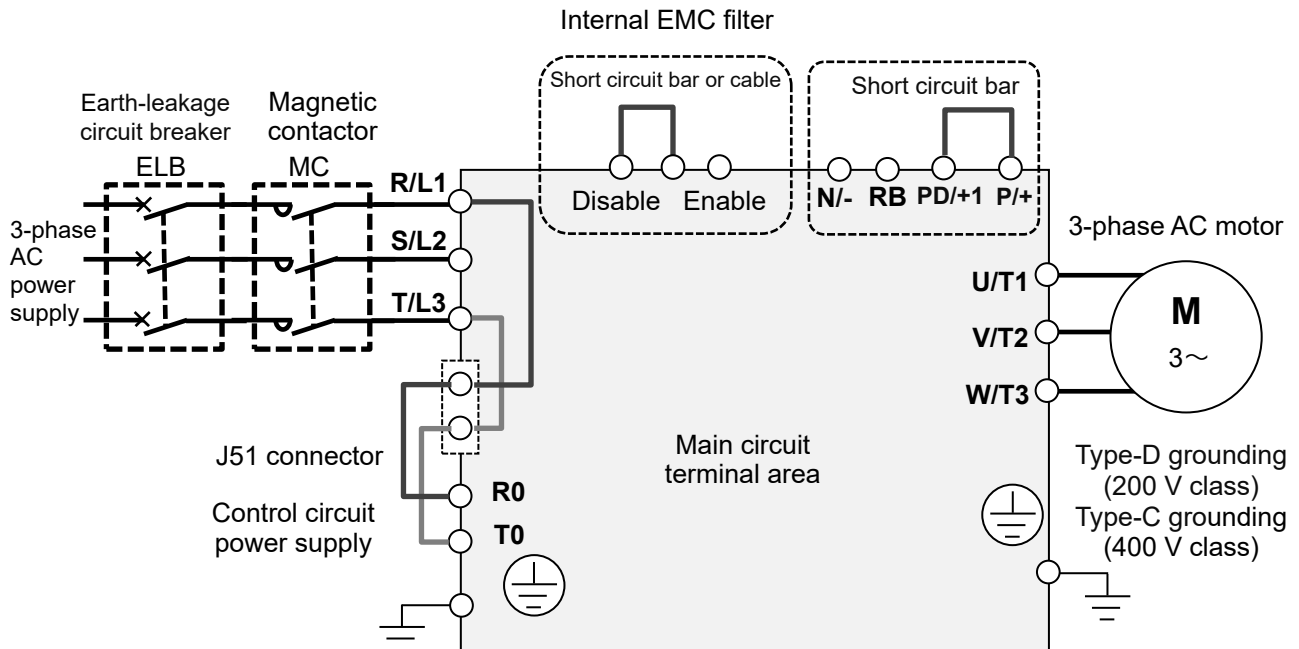

7.5.8 Wiring Separately to the Control Circuit Power Supply

Q

- I want to use a separate power supply for the control circuit.
- I want to retain the alarm signal even when the protection circuit of the inverter operates and shuts off the magnetic contactor on the input source of inverter.

!

- When the protection circuit of the inverter operates and shuts off the magnetic contactor on the input supply of inverter, there will be no power supply that controls the inverter, and the alarm signal of the output terminal function [AL] cannot be retained. To retain the alarm signal, use the control circuit power supply R0 and T0.



- By the following procedure, connect the terminals for control circuit power supply R0 and T0 to the primary side of the magnetic contactor.

- Loosen the screws and remove the wires connected to R0 and T0.
- Remove the whole J51 connector.
- Connect the control circuit power supply to R0 and T0.



Do

- For R0/T0 terminal wire (terminal screw size: M4), use a gauge of 1.25 mm² or more. The tightening torque is 1.2 N·m to 1.4 N·m.
- Connect a 3 A fuse to the power line for the control circuit.

A

- To create a separate line for the control circuit power supply, remove the J51 connector and directly connect the power supply (two wires of the main circuit voltage). If there is abnormality on the main circuit area, you can change or read internal data while the main circuit area is turned off.
- When 24 VDC power is supplied to P+ and P- from an external supply, you can change or read data only with the input of 24 VDC power supply.

!

- If you turn on the control circuit power supply R0 and T0 in advance of the main circuit power supply R, S, and T, ground fault detection is performed upon main circuit power-on.
- When connecting a DC power supply to the control circuit power supply R0, T0, set the output terminal active state [11] to [16], [AL] parameters to 00 (Normally Open). Please note that the output signals with 01 (Normally Closed) setting may chatter when the DC power supply is cut off.

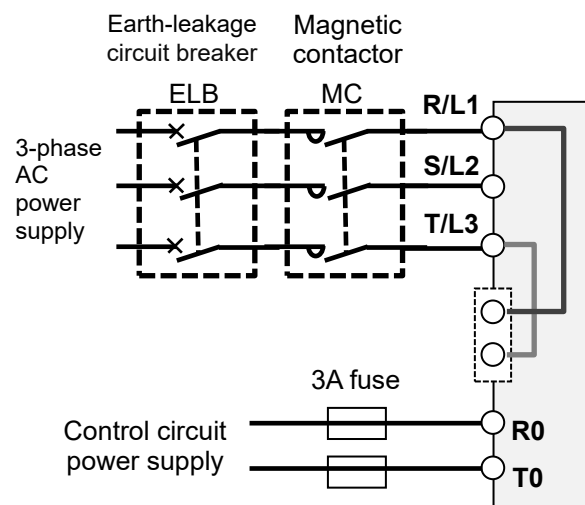

Specification of power supply to the control circuit power supply are below.

200 V class:

200 to 240 VAC (+10%, -15 %)(50,60 Hz ± 5%)
or 282 to 339 VDC

400 V class:

380 to 500 VAC (+10%, -15%)(50,60 Hz ± 5%)
or 537 to 707 VDC

7.5.9 Outline of Applicable Peripheral Devices

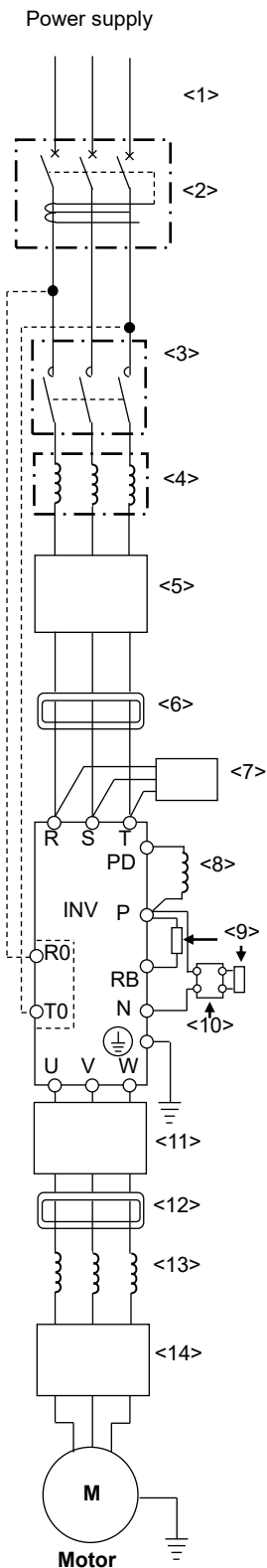

Cautions

- The applicable devices shown in this chapter are those when Hitachi standard 3-phase 4-pole cage motor is used.
- For the circuit breaker, choose an appropriate device by taking breaking capacity into consideration. (Use an inverter-compatible model.)
- To ensure safety, use an earth-leakage breaker (ELB).
- Use a 75°C copper wire (HIV wire).
- If the wiring length exceeds 20 m, a thick power line needs to be used.
- Use an alarm output contact of 0.75 mm².
- Tighten the terminal screws at a specified torque. If they are not tightened enough, it may cause short circuit or fire. If they are tightened too much, it may damage the terminal block or inverter.
- Employ different sensitive currents for earth-leakage breaker (ELB) depending on the total wiring length between the inverter and power supply and between the inverter and motor. Also, use a inverter ready type earth-leakage breaker. High-speed type products may malfunction.
- If wiring is performed on a metal tube using CV wire, leak current is about 30 mA / km.
- As relative permittivity of IV wire is high, the current increases by about 8 times. Therefore, use an item with 8 times sensitive current that is shown on the table below. If the total wiring length exceeds 100 m, use a CV wire.

Total wiring length	Sensitive current (mA)
100 m or shorter	50
300 m or shorter	100

- Do not pull the power line after wiring. It may cause loosening of screws.
- The inverter of 160 kW (P1-1600H) or more, use a reactor (DCL or ALI) as much as possible for power factor correction. (Normally, use DCL).

No.	Name	Function
<1>	Wire	See Chapter "7.5.4 Recommended Wire Diameter, Wiring Tools, and Crimping Terminals".
<2>	Earth-leakage breaker (ELB)	
<3>	Magnetic contactor (MC)	
<4>	Input side AC reactor (for harmonic suppression, power coordination, and improvement of power factor)(ALI-□□□□)	This is applied as a countermeasure against harmonic suppression, or when imbalance of power supply voltage is 3% or above, or when power supply capacity is 500kVA or above. It is also used when a rapid change is made to power supply voltage. It is also effective in improving power factor.
<5>	Inverter noise filter (NF-□□□)	This reduces the conductive noise that is generated from the inverter and transferred to the wire. Connect to the primary side (input side) of inverter.
<6>	Radio noise filter (zero-phase reactor) (ZCL-□)	When the inverter is used, noise may be generated on an adjacent radio or other devices through wiring on the power supply side. This is used for reducing the noise (reducing radiation noise).
<7>	Input-side radio noise filter (capacitor filter) (CFI-□)	This reduces the radiation noise that is emitted from the wire on the input side.
<8>	DC link Choke (DCL-□-□□)	This suppresses harmonics generated from the inverter. It is also effective in improving the power factor.
<9>	Braking resistor	This is used for increasing the braking torque of inverter, repeating power on and off at high interval, or reducing the speed of high load caused by moment of inertia.
<10>	Regenerative braking unit (BRD-□□)	
<11>	Output-side noise filter (ACF-C□)	This is installed between the inverter and motor to reduce the radiation noise that is emitted from the wire. It is used to reduce radio interference on radios or televisions or prevent malfunctioning of measurement instruments and sensors.
<12>	Radio noise filter (zero-phase reactor) (ZCL-□□□)	This is applied for reducing noise generated on the output side of inverter. (It can be used on both the input side and output side.)
<13>	Output-side AC reactor (ACL-□-□□) for reducing vibration/preventing malfunctioning of thermal relay	When a general-use motor is driven by the inverter, compared with when it is run by commercial power supply, larger vibration may be generated. By connecting this device between the inverter and motor, you can reduce the vibration of motor. Also, if the wiring length between the inverter and motor is long (10m or longer), by inserting a reactor, you can prevent malfunctioning of the thermal relay caused by harmonic attributable to switching of inverter. You can also use a current sensor instead of the thermal relay.
<14>	LCR filter	This is a filter installed between the inverter and motor. It improves output current and voltage waveform to reduce motor vibration, noise, and radiation noise emitted from the wire to convert output-side waveform to sine wave. It is also effective in suppressing surge voltage.

7.5.10 DC link choke (DC reactor) Connection Terminal (PD,P)



- I want to perform noise reduction.
- I want to take measures against harmonic noise.
- I want to improve power factor.



- These are terminals for connecting DC link choke (DC reactor) option used for improving power factor.
- Harmonic noise can be reduced by using the DC link choke (DC reactor) option.



- When using the DC link choke (DC reactor) option, connect it after removing the short circuit bar between the PD and P terminals.

Prohibited

- When not using the DC link choke (DC reactor) option, do not remove the short circuit bar between the PD and P terminals.

Electric shock

- If the short circuit bar between PD and P terminals is removed and the DC link choke option is not connected, power is not supplied to the main circuit area of inverter, and the inverter will not operate.

Do

- The wiring length to DC link choke shall be within 5m. Otherwise, the effect may not be obtained.

Caution

- When installing the DC link choke, please make sure that its heat does not affect the inverter.

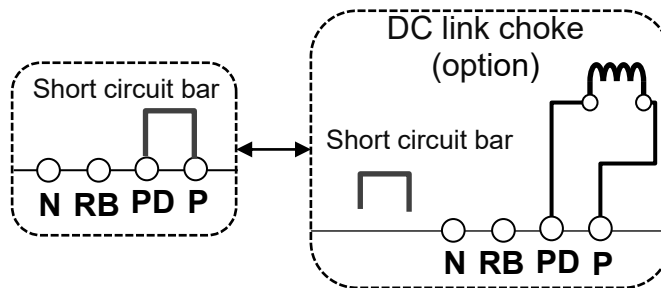

7.5.11 Regenerative Braking Option



- I want to set a short deceleration time, but overvoltage error occurs.
- When hanging the device for elevation or lowering, overvoltage error occurs.

■ Connection Terminals for External Braking Resistor (P, RB)



- In SJ series P1, braking resistor circuit is included in the following models as standard.
P1-00044-L (P1-004L) to P1-01240-L (P1-220L)
P1-00041-H (P1-007H) to P1-00930-H (P1-370H)
- By attaching the optional braking resistor, you can use the device even at large regenerative load (lowering load or load applied at high-speed rotation).

- With the braking resistor and regenerative braking unit, you can improve braking power and suppress overvoltage.
- To enhance braking power using an option, attach a braking resistor or braking unit.

Prohibited

- Do not attach a resistor whose resistance is lower than the predefined value. Otherwise, the regenerative braking (BRD) circuit may be damaged.

Failure

- Do not connect items other than the braking resistor to the RB terminal and P terminal.
- Do not short the RB terminal and P terminal.

Caution

- Please arrange the terminals so that heat generated from braking resistor does not affect the inverter.

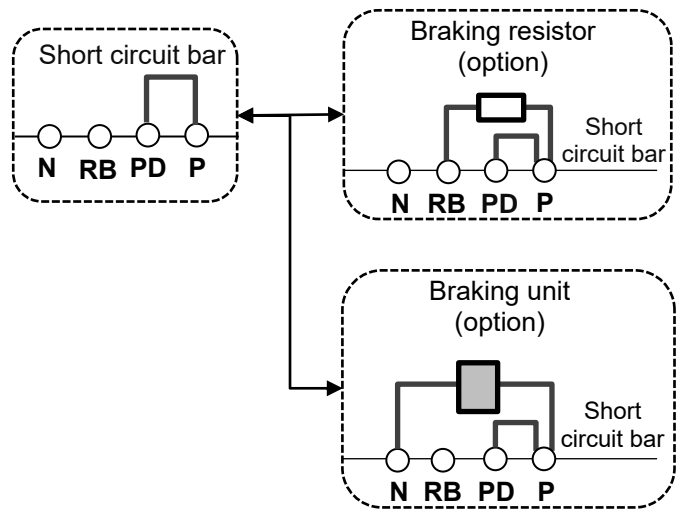

7.5.12 Inverter Ground Terminal (G)

Do

- Make sure that the inverter and motor are grounded for use.

Electric shock

- Otherwise, you run the risk of electric shock.

Do

- Use grounding wires whose thickness is not less than that of the applicable wires and make them short as much as possible.

Electric shock

Do

- In accordance with the electric installation engineering standards, connect 200V-class model to the earth electrode completing Type-D grounding work (equivalent to the third class grounding: 100Ω or less grounding resistance) and 400V-class model to the earth electrode completing Type-C grounding work (equivalent to the special third class grounding: 10Ω or less grounding resistance).

Electric shock

Prohibited

- When more than one inverters are used, connect them that the grounding route (condition) should not be cascaded or loops connection. Otherwise, the inverter or peripheral control devices may malfunction.

Malfunctioning

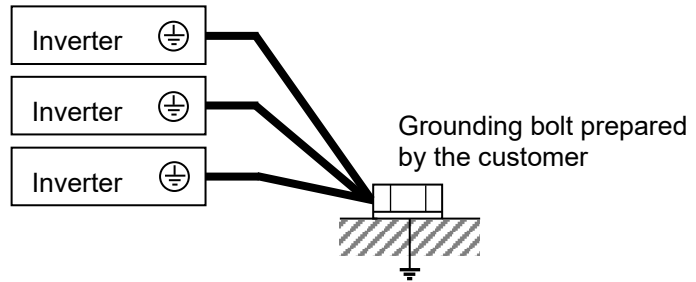
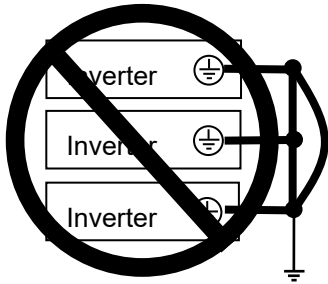

7.5.13 Enable the Internal EMC Filter

- Q**
- I want to enable the internal EMC filter.
 - I want to comply with European Directive.

- A**
- To enable the EMC filter, move the short circuit bar or cable.

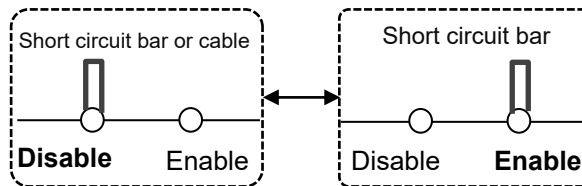

- !**
- For locations to be shorted, see the main circuit wiring diagram.

7.6 Operation and Optional Areas

7.6.1 Structure of Operation and Optional Areas

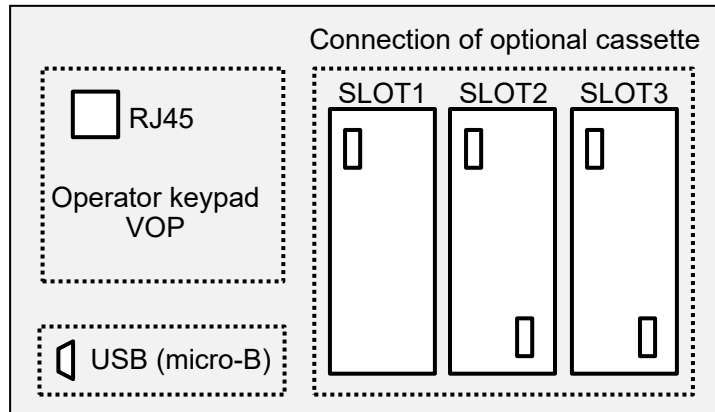

Operator keypad (factory default setting)
The operator keypad is connected by default.

Option connection (factory default state)
Optional slots are closed.

7.6.2 Description of Operation and Optional Areas

Connecting location	Name	Description
RJ45	Operator keypad VOP	The operator keypad VOP is connected. By using a straight LAN cable, the keypad VOP can be remotely operated. And it can be taken out of the cabinet.
SLOT1	Optional cassette slot 1	Various optional cassettes can be connected.
SLOT2	Optional cassette slot 2	Various optional cassettes can be connected. The encoder feedback option (P1-FB) can only be connected to the slot 2.
SLOT3	Optional cassette slot 3	Various optional cassettes can be connected. The functional safety option (P1-FS) can only be connected to the slot 3.
USB (micro-B)	Connecting area for PC	By connecting with a PC, perform communication with a set up software tool ProDriveNext.



- Before removing the operator keypad or disconnecting a USB device, be sure to turn off the power supply and wait until the POWER LED goes off.
- When removing the operator keypad or disconnecting a USB device, hold the front cover. Otherwise, it may cause connection failure.
- Some extended options have predetermined connecting locations.
- Feedback option -> Slot 2
- Function safety option -> Slot 3

7.6.3 Set Out the Operator Keypad on the Panel

Q

- I want to take out the operator keypad on the front side of the panel where the inverter is installed to operate it.

A

- The keypad VOP can be operated outside the control panel.
- Use the connector cable option ICS-1 (1m) or ICS-3 (3m) when removing the keypad VOP from the inverter.

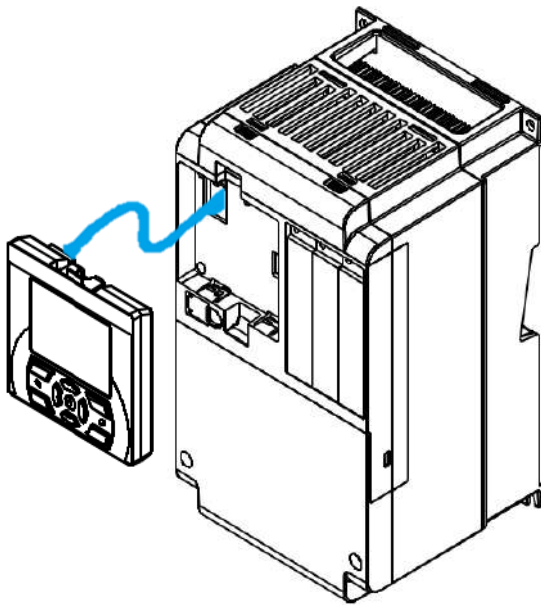

!

- Please use Cat.5e straight LAN cable when you prepare the cable by yourself. The following are examples of recommended manufacturers.

TSUKO:

Cat5e cable with connectors at both ends
(twisted wire)

TSUNET-MC350E-MP 8C B 8-8

Hitachi Metals, Ltd.:

Straight wire with connectors at both ends
NETSTAR-C5E PC 24AWG×4P

- Use a connector cable within 3m. If you use the connector exceeding 3m, it may cause malfunctioning.
- While power is supplied to the inverter, do not attach or remove the operator keypad.

7.7 Control Circuit Terminal Area

7.7.1 Switch Configuration

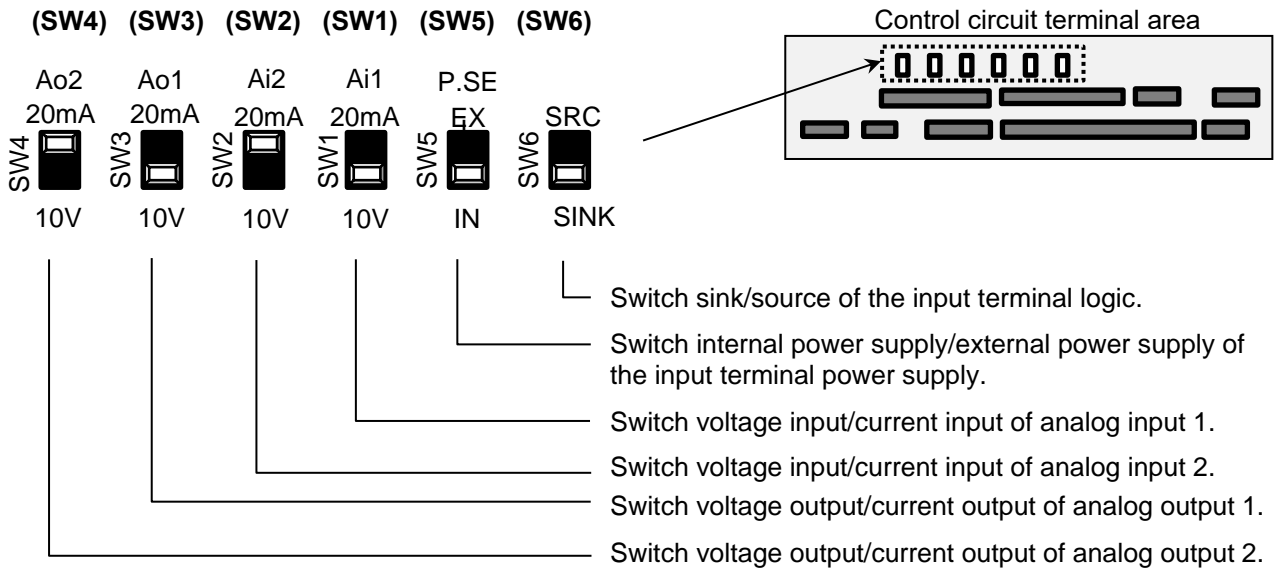

Points to be noted on switches

Failure (Warning icon)

- Using a switch under power-on condition may cause failure. Use the switch only after turning off the power and confirming that the POWER LED on the operator keypad is off.

Do (Info icon)

Failure (Warning icon)

- If the switch status does not match the actual input and output specifications, it may cause failure. Make sure to check that input and output to be used and switch characteristics are the same.

Do (Info icon)

Description of slide switches

Indication	SW name	Description
Ai1 (SW1)	Analog input 1 switch	Switches input specification of analog input 1 (Ai1 terminal). 10V: Voltage input is available. 20mA: Current input is available.
Ai2 (SW2)	Analog input 2 switch	Switches input specification of analog input 2 (Ai2 terminal). 10V: Voltage input is available. 20mA: Current input is available.
Ao1 (SW3)	Analog output 1 switch	Switches output specification of analog output 1 (Ao1 terminal). 10V: Output changes to voltage output. 20mA: Output changes to current output.
Ao2 (SW4)	Analog output 2 switch	Switches output specification of analog output 2 (Ao2 terminal). 10V: Output changes to voltage output. 20mA: Output changes to current output.
P.SEL (SW5)	Switching the method of power supply to the input terminals	Switches the method of power supply to the input terminals. IN: Drives the input terminals using the internal power supply. EX: Inputs an external power supply to drive input terminals. (In the case of EX, a power supply is required between the input terminals and COM.)
SRC/SINK (SW6)	Switch of sink/source for the input terminals	Switches the sink/source logic for input terminals. This switch is enabled when SW5 is IN. SINK: Enables sink logic. SRC: Enables source logic.

7.7.2 Wiring to the Control Circuit Terminal Block

■ Points to be noted on wiring the control circuit terminals

 Electric shock Failure

- L, COM, and CM2 are common terminals for input and output signals, and they are insulated from one another. Do not make these common terminals shorted or grounded.

 Prohibited

- Do not make them grounded via an external device.

 Mal-functioning

- Separate the wiring to the control circuit terminal block from that of the main circuit line (power line) or relay control circuit. If it is unavoidable to do so, make them positioned at right angles to each other. Otherwise, the inverter may malfunction.

 Do

 Do

- Although the control circuit terminal block has two lines, you can easily perform wiring by starting from the lower terminals. Make setting to perform wiring from the lower area.

 Do

- When wiring between Ai1 and L and between Ai2 and L, make sure to check that the positions of the corresponding DIP switches SW1 and SW2 are at the desired input (voltage or current).

 Failure

- Input of erroneous voltage or current caused by erroneous selection of switch or input of a value outside the specification range (using P24 terminal (24V) instead of H terminal (10V)), incorrect wiring (wires are installed in reverse orientation and input of voltage/current is reversed, short circuit occurs between H and L, wiring of a knob causes short circuit between H and L at 0Ω, etc.) may cause failure.

 Prohibited

 Mal-functioning

- For wiring to the control circuit terminal block, use twisted shield wires, and connect the shield films to each common terminal.

 Do

 Mal-functioning

- The wiring length to the control circuit terminal block shall be within 20m. If the connecting wire exceeds 20m, you may not be able to get sufficient characteristics due to effects of voltage drop. If it is unavoidable to set the length to more than 20m, use an analog insulation signal converter, and check that there is no problem with operation.

 Do

 Mal-functioning

- After wiring, lightly pull the wires to check that wires are securely connected.

 Do

 Do

- For output terminals and relay output terminals, install a diode for preventing counter-electromotive force.

 Failure

- Otherwise, counter-electromotive force is applied, which may cause failure.

Recommended terminals for wiring

For the convenience of wiring and improvement of connection reliability, it is recommended to use rod terminals with the following specifications.

For the control circuit terminal block, a spring clamp type terminal block is employed.

Rod terminals with sleeve

Wire size mm ² (AWG)	Rod terminal model *1	L1 [mm]	L2 [mm]	φ d [mm]	φ D [mm]
0.25 (24)	AI 0,25-8YE	8	12.5	0.8	2.0
0.34 (22)	AI 0,34-8TQ	8	12.5	0.8	2.0
0.5 (20)	AI 0,5-8WH	8	14	1.1	2.5
0.75 (18)	AI 0,75-8GY	8	14	1.3	2.8

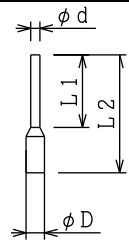

*1) Manufacturer: Phoenix Contact GmbH & Co. KG

Crimping tool: CRIMPFOX 6



Method of wiring/detaching wires

1. Push the orange part shown below on the control circuit terminal block into the socket with a slotted screwdriver (with a wide of 2.5mm or less). (Insertion hole will open)
2. Plug in the wire or ferrule terminal to the wire insertion hole (round) while pressing the orange part with a slotted screwdriver.
3. The wire is connected to the circuit when release the screw driver.



Even for pulling out the wire from the socket, press the orange part with a slotted screwdriver (the insertion hole will be opened while pressing).

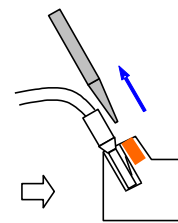
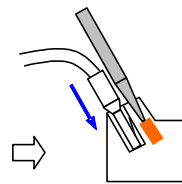
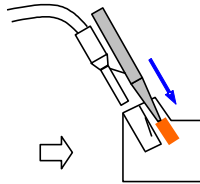
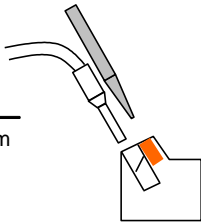
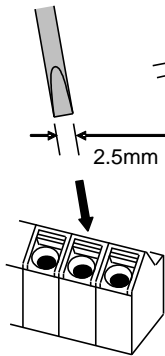

Push the orange part into the socket with a slotted screwdriver.

Insert the wire.

The wire is connected to the circuit when release the screw driver.

7.7.3 Lower Portion Wiring of the Control Circuit

· [] indicates the factory default setting.

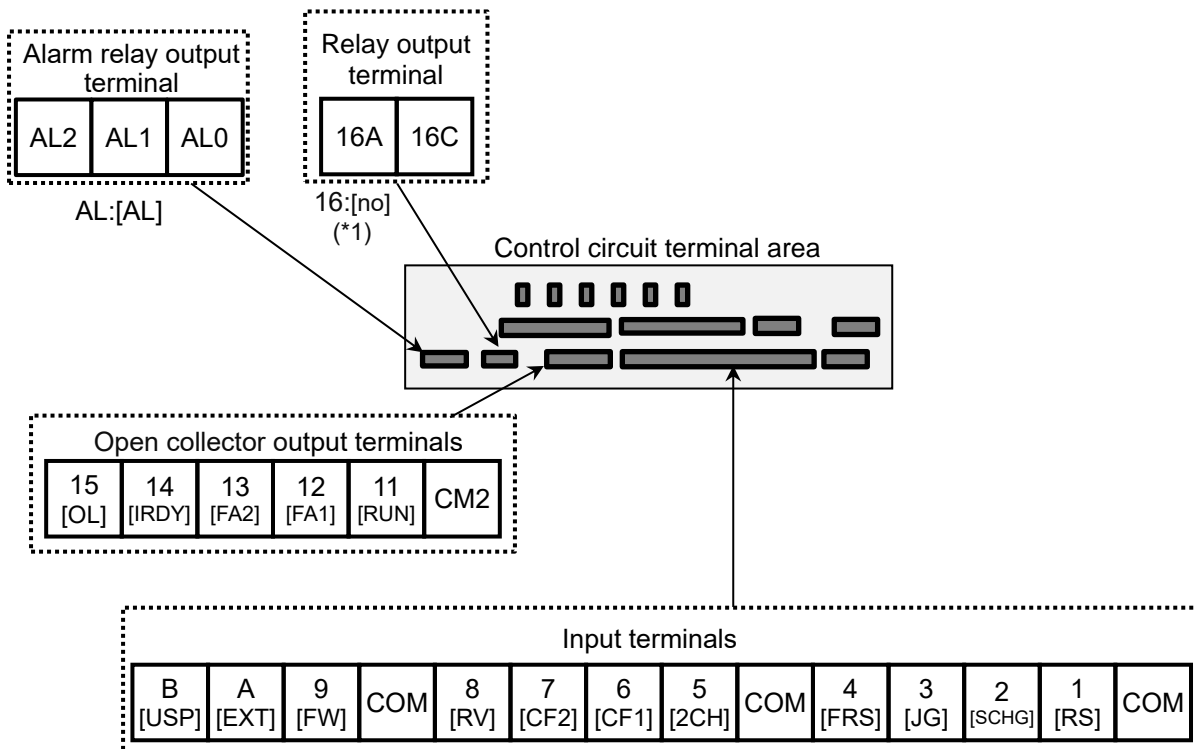

(*1) Ver2.01 or older, the initial value of the relay output 16 is 040 [ZS]

Mal-functioning

- When connecting contacts to control circuit terminals, use a relay that does not generate contact failure even at weak current or voltage emitted from cross-bar twin contacts.

Do

Logic of input terminals

Using SW6, switch the sink/source logic.

Failure

- When connecting a relay with output terminals, connect a diode for absorbing surge in parallel with the coil. Otherwise, internal elements may burn. (See the chapter for output terminals)

Do

Input terminals

- All COMs have the same electric potential.
- Change SW5 to external power source (EX) to connect the power source between Input terminals 1 to 9, A,B, and COM.
- Sink or source logic of the input terminal is switched by SW6.

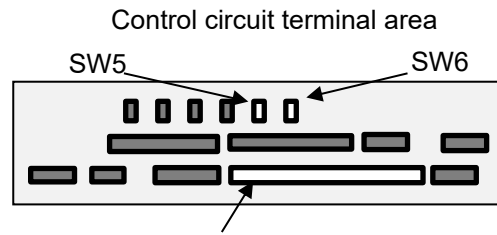

(Wiring example)

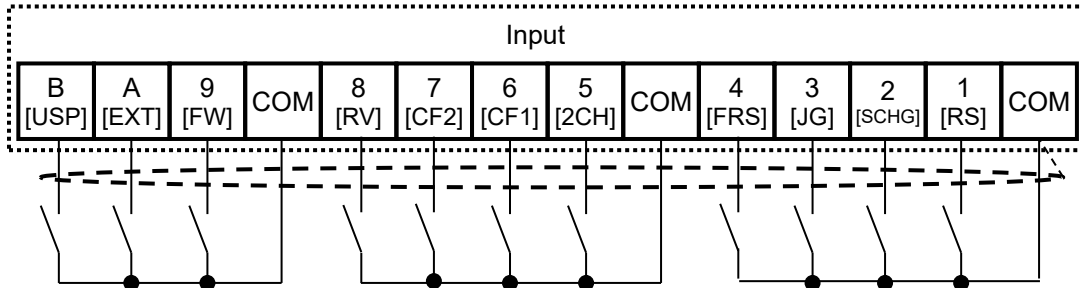

• [] it means factory default settings.

		Terminal symbol	Terminal name	Description	Electrical characteristics	
Intelligent input terminals	Digital input	Contact/pulse	Contact	9, 8, 7, 6, 5, 4, 3, 2, 1	Input terminal	• Max. allowable voltage 27 VDC • Load current 5.6 mA(at 27 VDC) Voltage between each input and the COM terminal: When using an external power supply: • ON voltage Min. 18 VDC • OFF voltage Max. 3 VDC When using the internal power supply: • ON voltage Max. 3 VDC • OFF voltage Min. 18 VDV • Maximum 32kpps pulse input (When terminal A and B function is pulse train input A/B)
			A	Pulse input-A	When [CA-90] is set to 00, A and B terminals can be used as input terminals. Each terminal can select input terminal functions by parameter setting.	
			B	Pulse input-B	When [CA-90] is not set to 00, they are used as terminals for pulse train input. The maximum input pulse is 32 kpps.	
	Common	COM	Input (common)	This is a common terminal for digital input terminals (1,2,3,4,5,6,7,8,9,A and B). Three COM terminals are available.		

Terminal's default function (Setting No[symbol])

- 028[RS] Reset
- Reset at every trip. (Except for special conditions.)

015[SCHG] Main/Sub speed reference change

- Change to the main speed command [AA101](OFF) or sub-speed command [AA102](ON).

029[JG] Jogging

- Run at a frequency of [AG-20] upon receipt of the RUN command by [JG]ON.

032[FRS] Free-run stop

- [FRS]ON sets the motor in a free-run state.

031[2CH] 2-stage Acceleration/Deceleration

- [2CH]ON enables acceleration/deceleration time-2[AC124][AC126].

033[EXT] External fault

- [EXT]ON issues fault[E012].

001[FW] Forward rotation and

002[RV] Reverse rotation

[FW]	[RV]	Description
OFF	OFF	No command
ON	OFF	Forward rotation RUN command.
OFF	ON	Reverse rotation RUN command.
ON	ON	No command (inconsistent logic)

003[CF1] Multi speed selection 1 and

004[CF2] Multi speed selection 2 commands

[CF1]	[CF2]	Description
OFF	OFF	The set frequency command is enabled
ON	OFF	The frequency source of [Ab-11] is enabled.
OFF	ON	The frequency source of [Ab-12] is enabled.
ON	ON	The frequency source of [Ab-13] is enabled.

*) When 005[CF3] and 006[CF4] are set, up to 15 speeds can be set.

034[USP] Unattended start protection

- In a [USP]ON state, if an RUN command has been input before the power supply is ON, fault[E013] is issued.

■ Output terminals
(Wiring example)

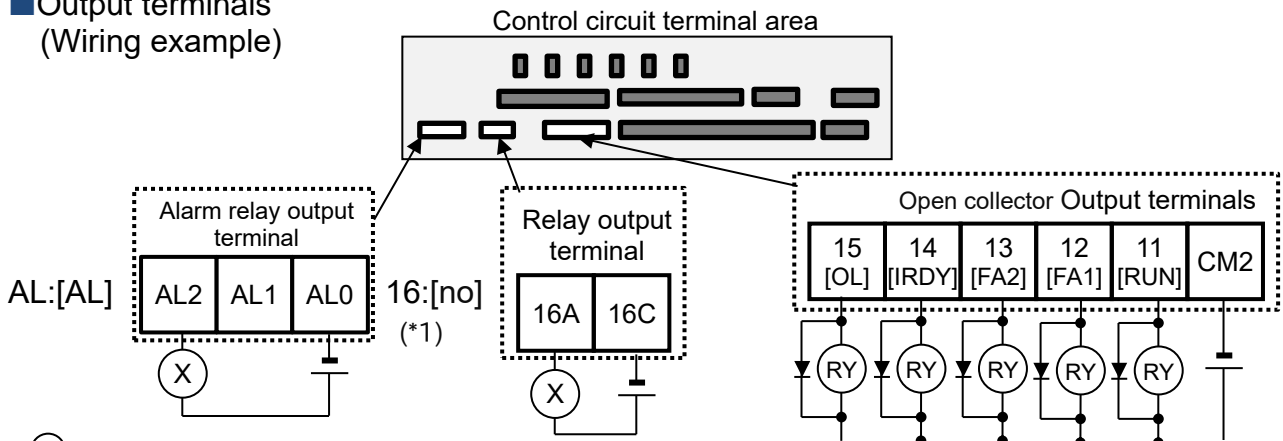

(X) : Equipment including lamps, relays and PLC
(RY) : Relays

* Make sure to use diode. Otherwise, the internal circuit may be damaged.
· [***] it means factory default settings

		Terminal symbol	Terminal name	Description	Electrical characteristics	
Intelligent output terminals	Digital output	Open collector	15,14 13,12 11	Output terminals	Terminal functions are selectable according to the parameter settings for each terminal. These are available for both Sink and Source logics.	Open collector output · Between each terminal and CM2 · Voltage drop at ON: 4 VDC or less · Max allowable voltage: 27 VDC · Max allowable current: 50 mA
			CM2	Common for output terminal	This is a common terminal for output terminals 11 to 15	
	Relay		16A 16C	1a relay terminals	A relay for A contact outputs	Maximum contact capacity 250 VAC, 2 A(resistance) / 250 VAC, 1 A(inductive load) 30 VDC, 3 A(resistance) / 30 VDC, 0.6 A(inductive load) Minimum contact capacity · 5 VDC, 10mA
			AL0 AL1 AL2	1c relay terminals	A relay for C contact outputs	Maximum contact capacity AL1/AL0 : 250 VAC, 2 A(resistance) / 250 VAC, 0.2 A(inductive load) 30 VDC, 3 A(resistance) / 30 VDC, 0.6 A(inductive load) AL2/AL0 : 250 VAC, 1 A(resistance) / 250 VAC, 0.2 A(inductive load) 30 VDC, 1 A(resistance) / 30 VDC, 0.2 A(inductive load) Minimum contact capacity(common) 100 VAC, 10 mA / 5 VDC, 100 mA

■ Initial terminal function

001[RUN] Running

- Turns ON during operation (PWM output).

002[FA1] Constant-frequency reached

- Turns ON when the output frequency reaches the command frequency.

003[FA2] Set frequency overreached

- Turns ON when the output frequency reaches the set frequency [CE-10] to [CE-13].

007[IRDY] Inverter ready

- Turns ON when operation is ready.

035[OL] Overload notice advance signal

- Turns ON when current exceeds the level of overload warning level.

017[AL] operation

- When [CC-17] = 00

Power supply	Status	AL0-AL1	AL0-AL2
ON	Normal	Open	Closed
ON	Trip	Closed	Open
OFF	—	Open	Closed

- When [CC-17] = 01

Power supply	Status	AL0-AL1	AL0-AL2
ON	Normal	Closed	Open
ON	Trip	Open	Closed
OFF	—	Open	Closed

*) For details on relay output, see also 12.19.1 and 12.25.2 for details on relay output.

(*1): Ver2.01 or older, the initial value of relay output 16 is 040[ZS].
040[ZS] 0 Hz detection signal

- Turns ON when the output frequency goes below the Zero speed detection level [CE-33].

7.7.4 Upper Portion Wiring of the Control Circuit

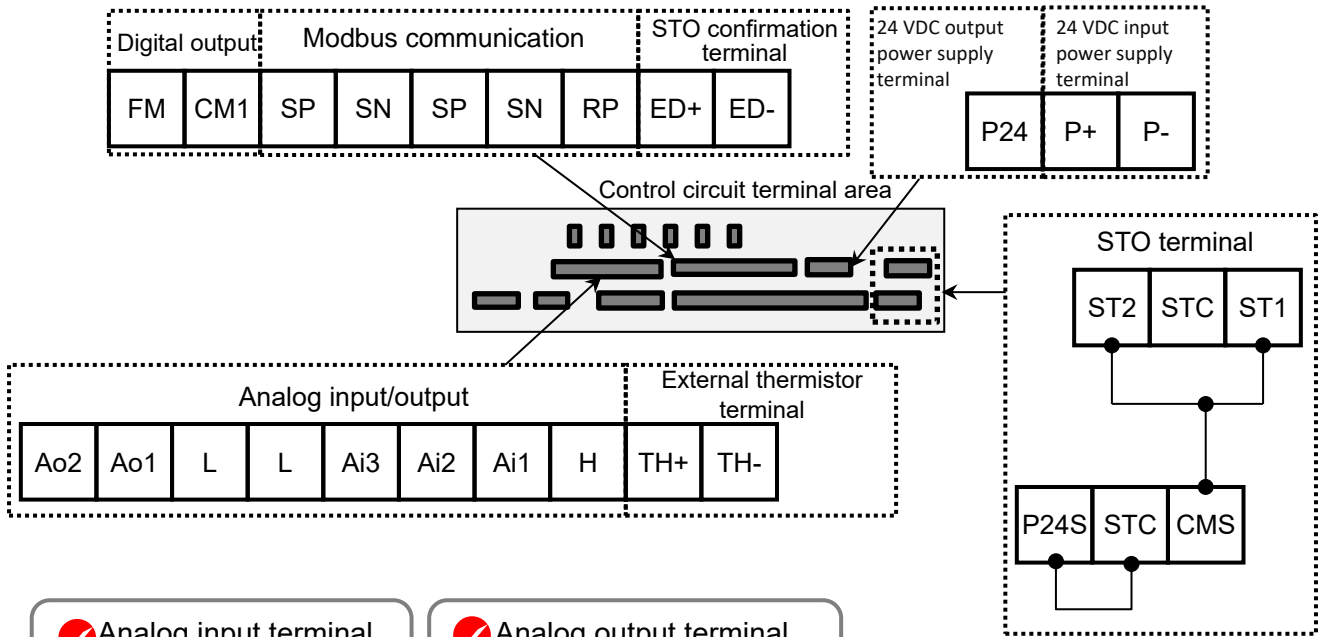

✓ Analog input terminal (factory default state)
 The corresponding switches are as follows.

- Ai1 (voltage input): SW1
- Ai2 (current input): SW2

✓ Analog output terminal (factory default state)
 The corresponding switches are as follows.

- Ao1 (voltage output): SW3
- Ao2 (current output): SW4

✓ Connection of STO terminal
 When shipped from the factory, wiring is performed so that STO terminal is disabled.

Failure (Warning icon)

- Do not short between the analog power supply H and L terminals, power supply P+ and P- terminals, P24 and P- terminals, P+ and CM1 terminals, and P24 and CM1 terminals.

Prohibited (No symbol icon)

- Otherwise, the inverter may fail.

Failure (Warning icon)

- When using an external 24 VDC power supply into P + and P-, be careful not to shut off the power supply while operating the inverter, such as changing parameters or operating other functions.
- Otherwise, the inverter may fail. (It may cause the memory error.)

■ Analog input/output
(Wiring example)

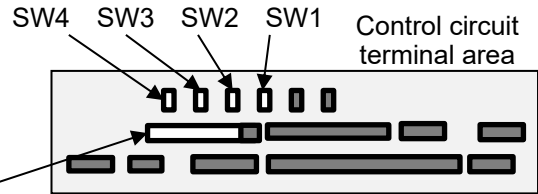
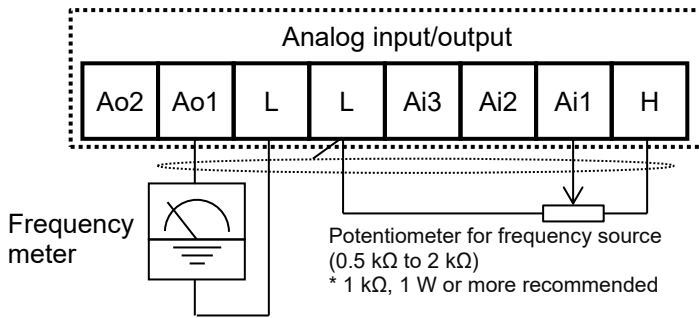

- In the example shown on the left, voltage is input when the variable resistor is used in H-Ai1-L, therefore, set the SW1 of analog input 1 (Ai1) to the voltage side.
- In the example shown on the left, if the frequency meter supports current measurement feature (4 to 20 mA), set the SW3 of analog output 1 (Ao1) to the current side of SW3.

	Terminal symbol	Terminal name	Description	Electrical characteristics	
Voltage/current switchable analog input/output terminal	Power supply	L	Analog power common	Common terminals for analog input terminals (Ai1, Ai2, Ai3) and analog output terminals (Ao1, Ao2). There are two L terminals.	
		H	Power supply for setting speed	This is a 10 VDC power supply. It is used when using analog input terminals (Ai1, Ai2, Ai3) and variable resistor for inputting voltage.	Allowable load current is 20 mA or less
	Analog input	Ai1	Analog input terminal 1 (voltage/current switching SW1)	For Ai1 and Ai2, 0 to 10 VDC voltage input and 0 to 20 mA current input can be switched using a switch for use. It can be used for input frequency command or feedback.	In the case of voltage input: • Input impedance about 10 kΩ • Allowable input voltage -0.3 to 12 VDC
		Ai2	Analog input terminal 2 (voltage/current switching SW2)		In the case of current input: • Input impedance about 100 Ω • Max allowable input current 24 mA
		Ai3	Analog input terminal 3	-10 to 10 VDC voltage input is available. It can be used for input frequency command or feedback.	Only voltage input: • Input impedance about 10 kΩ • Allowable voltage input -12 to 12 VDC
	Analog output	Ao1	Analog output terminal 1 (voltage/current switching SW3)	For Ao1 and Ao2, 0 to 10 VDC voltage output and 0 to 20 mA current output can be switched using a switch as output of information monitor data of the inverter.	In the case of voltage output: • Max allowable output current 2 mA • Output voltage accuracy ±10% (ambient temperature: 25°C ± 10°C)
		Ao2	Analog output terminal 2 (voltage/current switching SW4)		In the case of current output: • Allowable load impedance 250 Ω or below • Output current accuracy: ± 20% (ambient temperature: 25±10°C)

■ External thermistor
(Wiring example)

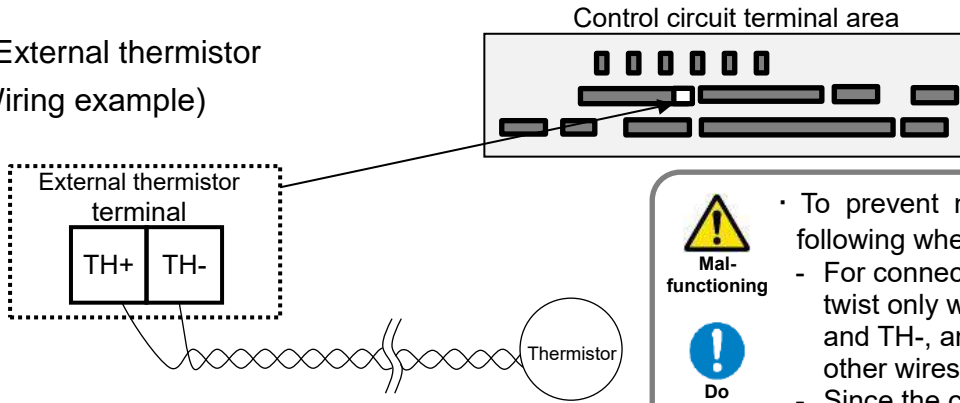



Mal-functioning

- To prevent malfunctioning, note the following when performing wiring.
- For connection to the TH terminal, twist only wires connecting to TH+ and TH-, and separate them from other wires.
- Since the current flowing in the thermistor is very weak, separate the wires from main circuit line (power line).
- The length of wiring to the thermistor shall be within 20 m.

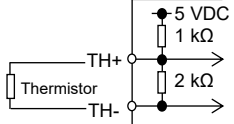

Do

		Terminal symbol	Terminal name	Description	Electrical characteristics
Thermistor terminal	Analog input	TH+	External thermistor input	When an external thermistor is connected, and resistance abnormality occurs due to abnormal temperature, etc., trip the inverter. Connect the thermistor with TH+ and TH-. The level of detecting resistance abnormality can be adjusted from 0 to 10000 Ω. [Recommended thermistor characteristics] Recommended product: SHIBAURA ELECTRONICS Co., Ltd. [PB-41E] Allowable rated power: 100 mW or more Impedance at abnormal temperature: 3 kΩ	0 to 5 VDC [Input circuit] 
		TH-	Common for external thermistor		

■ FM output terminal
(Wiring example)

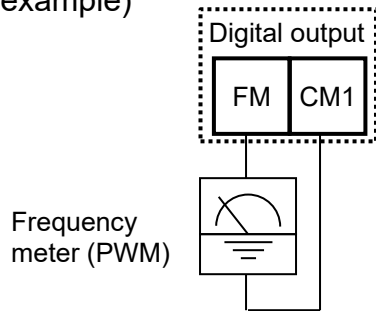

A

- For FM output, you can choose the PWM output method with 6.4 ms fixed interval or pulse output method in which pulse frequency varies.
- The FM output is adjusted by setting [Cd-01] to [Cd-03] / [Cd-10] to [Cd-15]. For details, refer to “12.25.5 Digital Output Settings”.

		Terminal symbol	Terminal name	Description	Electrical characteristics
Digital output	Monitor output	FM	Digital monitor (voltage)	For digital monitor output, you can choose the PWM output method at 6.4 ms interval or pulse output method with about 50% duty in which frequency varies.	Pulse train output 0 to 10 VDC • Maximum allowable current 1.2 mA • Maximum frequency 3.60 kHz
		CM1	Common for digital monitor	The common terminal for digital monitor. This is also used as 0V reference potential for P24.	

■ Power input/output
(Wiring example)

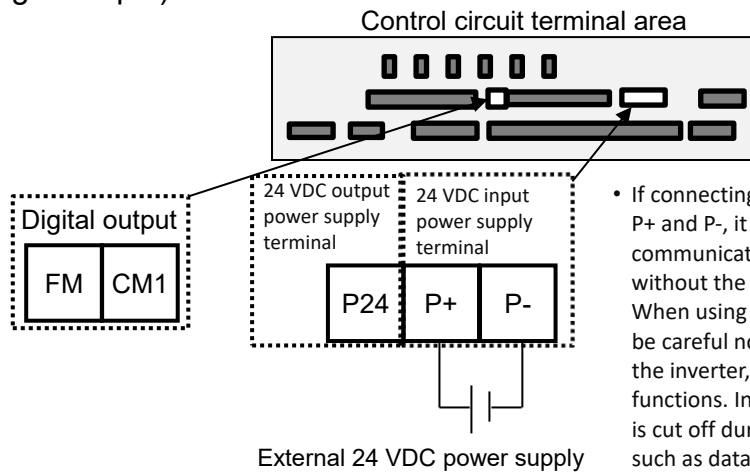

- If connecting 24 VDC external power supply into the terminal P+ and P-, it is able to change parameters, perform optional communication, digital/analog input/output and running EzSQ without the main power supply. When using an external 24 VDC power supply into P+ and P-, be careful not to shut off the power supply while operating the inverter, such as changing parameters or operating other functions. In particular, please note that if an external 24 VDC is cut off during storage processing to the internal memory such as data read/write function of the keypad, writing to the holding register by Modbus communication and/or etc. It may cause the memory error.

		Terminal symbol	Terminal name	Description	Electrical characteristics
24 VDC power supply	Input / output	P24	24 VDC output power terminal	This terminal supplies 24 VDC power for contact signals. CM1 terminal is common for P24 terminal.	100mA output at maximum
		P+	External 24 VDC power supply input terminal (24 VDC)	With this 24 VDC power supply, It is possible to read and write parameters, I/O inputs and outputs, communicate with options, and etc. without power supply to the main circuit R,S,T terminals and the control circuit R0,T0 terminals. Note that the P+/P- is for backing up the power supply of the control circuit. so if power is supplied to the main circuit R,S,T terminals and P+/P- terminals, and not supplied to the R0/T0 terminals, the inverter cannot be driven.	Allowable input voltage 24 VDC±10% Maximum power consumption 1A
		P-	External 24 VDC power supply input terminal (0 VDC)		

Serial communication
(Wiring example)

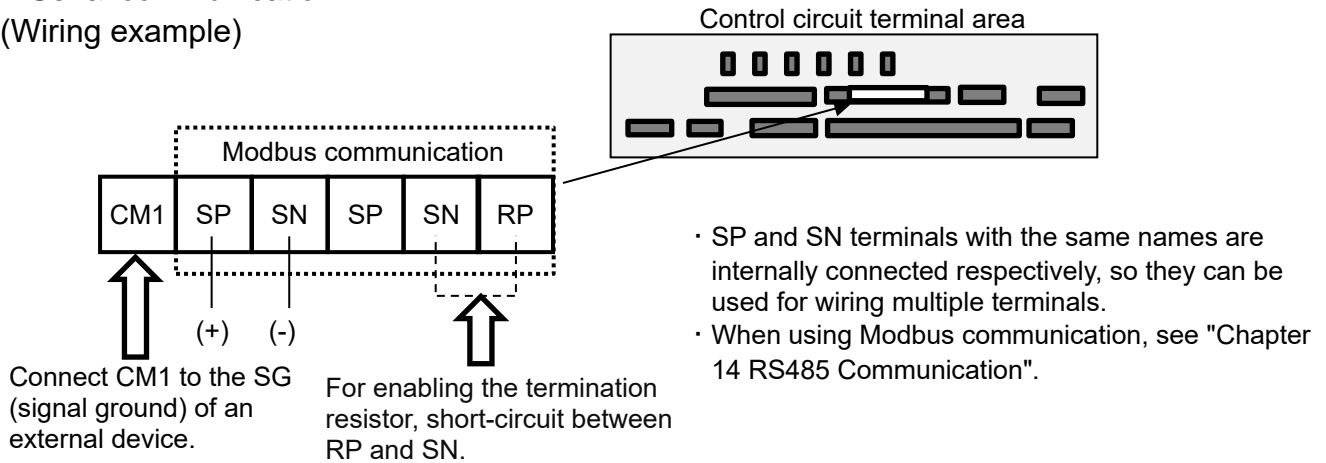

	Terminal symbol	Terminal name	Description	Electrical characteristics
RS485 communication	SP SN RP (CM1)	MODBUS terminal (RS-485)	SP terminal: RS-485 differential (+) signal SN terminal: RS-485 differential (-) signal RP terminal: Connect to SP through a terminating resistor CM1 terminal: Connect to the signal ground of external communication devices. (Used with the common terminal for FM output.) There are two SP terminals and they are connected internally for daisy chain connection. The SN terminals connection is same as the SP terminals too. Maximum baud rate is 115.2 kbps.	Equipped with terminating resistor (120 Ω) Enable: Short RP-SN Disable: Open RP-SN

STO terminal

- For the terminal function, see "21.4 STO Terminal Functions".
- * The section above describes only the function of STO terminal. If certification of function safety is needed, see the SJ-P1 Safety Function Guide (NT2512*X) separately provided.

Terminal symbol	Terminal name
P24S	24V power supply terminal (STO dedicated terminal)
CMS	24V power supply common terminal (STO dedicated terminal)
STC	Logic switching terminal
ST1	STO input1
ST2	STO input2
ED+	EDM signal output terminal (+)
ED-	EDM signal output terminal (-)

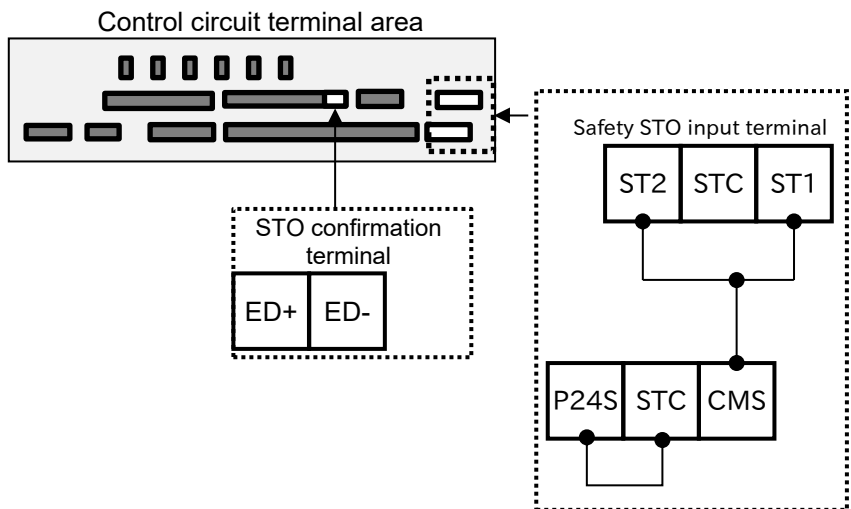

8

Chapter 8 Operation Check/Residual Risks

Contents

8.1 What This Chapter Explains	8-1
8.2 Content of the Checklist.....	8-1
8.3 Sections with Residual Risks.....	8-2
8.4 Residual Risk Checklist.....	8-3

8.1 What This Chapter Explains

This chapter describes residual risks in operation and items to be checked concerning the risks.

The customer who use this product shall appropriately perform risk assessment before performing trial run or using the product, and appropriately protect their personnel and systems.

Although this chapter describes all the possible measures to make sure, it does not cover all the risks in your systems. Please note that we will bear no responsibility for damages resulting from causes described in this chapter. Make sure to perform risk assessment of the system equipped with this product.

Also, make sure to carefully read “Chapter 1 Safety Instructions/Risks” for safety work.

8.2 Content of the Checklist

The items in the checklist shown in the next section are classified in accordance with the following definitions in the same way as "Chapter 1 Safety Instructions/Risks".

DANGER

Indicates that incorrect handling may cause hazardous situations, which have a high chance of resulting in serious personal injury or death, and may result in major physical loss or damage.

WARNING

Indicates that incorrect handling may cause hazardous situations, which may result in serious personal injury or death, and may result in major physical loss or damage.

CAUTION

Indicates that incorrect handling may cause hazardous situations, which may result in moderate or slight personal injury or damage, and may result in physical loss or damage alone.

8.3 Sections with Residual Risks

Please check for residual risks before turning on the power supply upon completion of the installation.

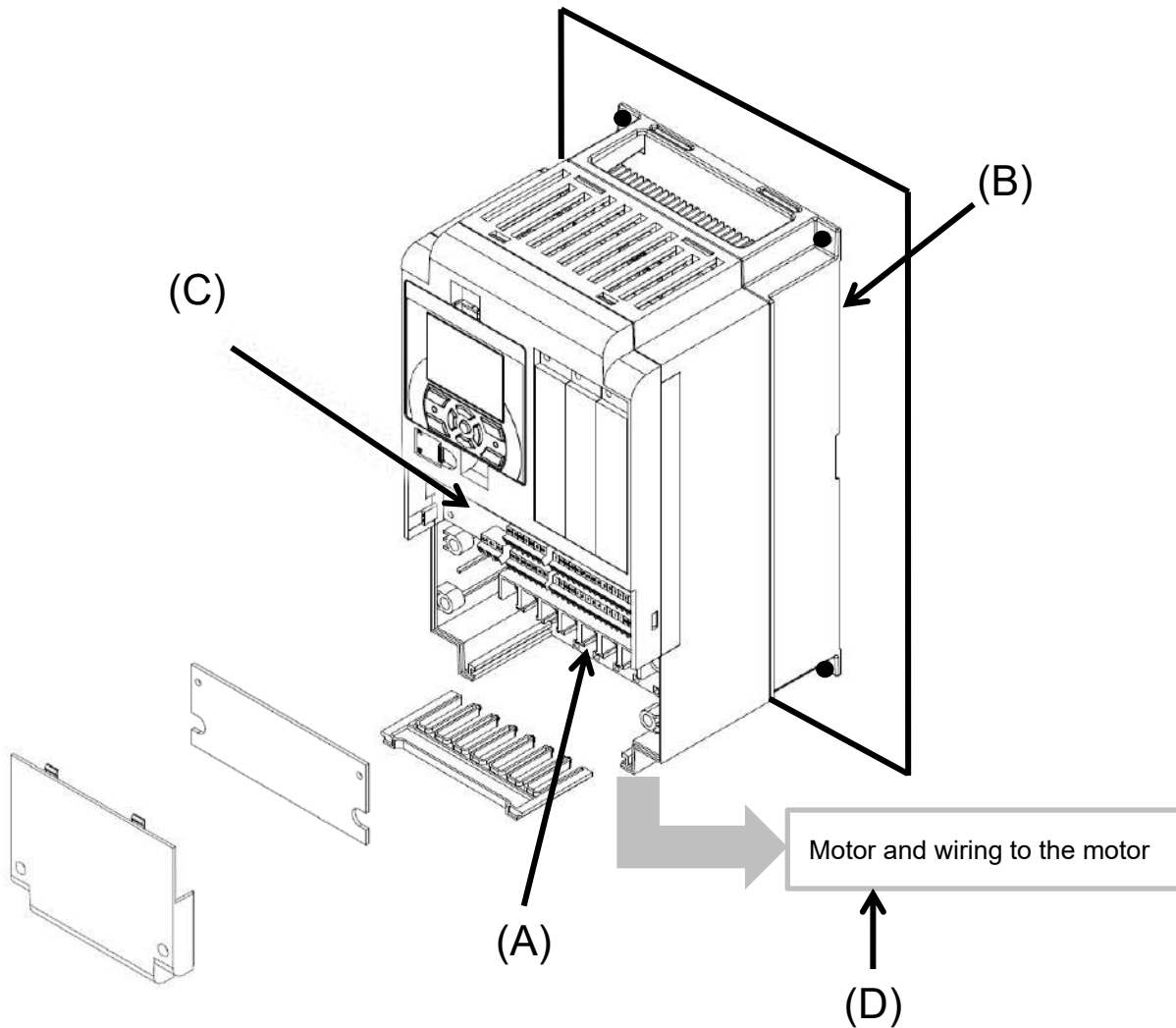

Residual risk checklist No.

No.	Section name	DANGER	WARNING	CAUTION
(A)	Main circuit terminal block	8, 10		
(B)	Heat sink	4		1
(C)	Control circuit terminal block	11		
(D)	Motor connected with the inverter and wiring to the motor	12, 13		
-	Unknown section	9, 14, 15		2, 3, 5, 6, 7

8.4 Residual Risk Checklist

No.	Operation stage	Work	Target section	Residual risk	Details of harm	Protective measure	√
1	Installation	Installation	(B)	Caution	Damage caused by careless transport	Do not drop the product. Do not carry the inverter in a manner that applies force to the cover or operator keypad.	<input type="checkbox"/>
2	Installation	Installation	-	Caution	Reduction of component life due to use in a location exposed to direct sunlight or at a temperature outside the specification range.	Check that ambient temperature is within the standard specification range in the whole year by means of cooling and ventilation.	<input type="checkbox"/>
3	Installation	Installation	-	Caution	Failure due to short circuit caused by using in a location which humidity and condensation are out of standard range described in specification.	Check that ambient temperature is within the standard specification range in the whole year by means of cooling and ventilation. Otherwise, install the product in a location free from condensation.	<input type="checkbox"/>
4	Installation	Installation	(B)	DANGER	The cooling fin that is heated to exceed 150°C catches fire to a flammable wall.	Install the inverter on an inflammable metal wall.	<input type="checkbox"/>
5	Installation	Installation	-	Caution	Component failure due to entry of dust, corrosive gas, or other substances.	Install the inverter inside a totally enclosed panel.	<input type="checkbox"/>
6	Installation	Installation	-	Caution	Reduction of a component life due to degradation of cooling capability by horizontal installation.	Install the inverter vertically.	<input type="checkbox"/>
7	Installation	Installation	-	Caution	When the fin of the inverter is installed outside of cabinet, the cooling fan fails due to droplet, oil mist, etc.	When installing the fin of inverter outside the cabinet, install it in a location free from droplet, oil mist, etc.	<input type="checkbox"/>
8	Maintenance for installation	Electrical connections	(A)	DANGER	The arc flies due to screws loosened by vibration, and catches fire to the internal components.	Check screws are appropriately tightened on a regular basis.	<input type="checkbox"/>
9	Maintenance for installation	Electrical connections	-	DANGER	The arc flies due to screws loosened by vibration, and catches fire to the internal components.	Check screws are appropriately tightened on a regular basis. Do not place flammable materials near the installed inverter.	<input type="checkbox"/>
10	Maintenance for use	Wiring Inspection	(A)	DANGER	When the cover is removed, electric shock is caused in a high-voltage section.	Do not remove the cover when power is supplied. After power is turned off, wait 10 minutes or more to perform working.	<input type="checkbox"/>
11	Maintenance for use	Wiring Inspection	(C)	DANGER	When the operator removes the cover, electric shock is caused when a tool touches a high-voltage section.	Do not remove the cover when power is supplied. After power is turned off, wait 10 minutes or more to perform working.	<input type="checkbox"/>

* Installation, wiring, and setting work need to be performed by specialized technicians.

No.	Operation stage	Work	Target section	Residual risk	Details of harm	Protective measure	√
12 (a)	Installation	Electrical connections	(D)	DANGER	Due to long wiring length, the insulation of the motor degraded by surge, which eventually burns the motor.	If the wiring length exceeds 20m, shorten the motor wiring length. Or install the optional LCR filter and output side AC reactor.	<input type="checkbox"/>
12 (b)	Installation	Electrical connections	(D)	DANGER	By a motor is connected to the different voltage class inverter, insulation of the motor degraded, which eventually burns the motor.	Match the voltage class of inverter and that of motor.	<input type="checkbox"/>
12 (c)	Installation	Electrical connections	(D)	DANGER	Due to unstable output caused by imbalance of power supply voltage, undervoltage, extreme voltage drop, aging of motor, the motor burns, and eventually the inverter fails.	Check the receiving voltage of inverter, power receiving method, and power supply capacity are appropriate.	<input type="checkbox"/>
12 (d)	Maintenance for use	Wiring Inspection	(D)	DANGER	The short circuit failure caused by degradation of motor insulation, cracking of aged wires, etc., causes phase loss on inverter output, motor cable, and motor. Driving the inverter in such a condition burns the motor, and eventually the inverter fails.	Check there is no phase loss by inspection.	<input type="checkbox"/>
12 (e)	Installation Use	Setting	(D)	DANGER	By performing inappropriate parameter settings, high current flows in the motor, causing it to burn.	Set appropriate values for parameters related to motor electronic thermal function [bC110] to [bC225]. Set appropriate values for the settings of base frequency, rated motor voltage, motor constant, load type, DC braking and control mode.(representative parameters) Motor-related parameters: IM: [Hb102] to [Hb118] SM (PMM): [Hd102] to [Hd118] Control mode: [AA121] Load type selection: [Ub-03] DC braking: [AF101] to [AF109]	<input type="checkbox"/>
13	Use	Operation	(D)	DANGER	The stopped motor automatically starts running.	To restart the motor after stopping it by a function, define it in the system.	<input type="checkbox"/>
14	General	General	-	DANGER	Damage and injury caused by hidden risks.	Perform risk assessment on the system, and check that the fail safe function is incorporated into the system.	<input type="checkbox"/>
15	General	General	-	DANGER	Damage and injury caused by failure to obtain additional information concerning risks.	Obtain the latest version of User's Guide so that necessary information can be checked. Communicate information to the end users as necessary.	<input type="checkbox"/>

* Installation, wiring, and setting work need to be performed by specialized technicians.

* When using the 024[SET] input terminal function, also check the second setting parameters.

9

Chapter 9 Operating

Contents

- 9.1 What This Chapter Explains 9-1
- 9.2 Start Operating the Inverter! 9-2
 - 9.2.1 Operator Keypad and Icon Display 9-2
 - 9.2.2 Transition of Operator Keypad Screen 9-6
- 9.3 Let's Set Up the Parameters! 9-7
 - 9.3.1 Checking the List and Configuring "Scroll Mode" 9-7
 - 9.3.2 Changing a Parameter While Watching a Monitor "While screen" 9-11
- 9.4 Monitor Inverter Information! 9-13
 - 9.4.1 Three-Line Monitor Screen "Multi monitor" 9-13
 - 9.4.2 Setting Screen "While screen" 9-14
 - 9.4.3 Monitor with Large Characters "Huge monitor" 9-15
- 9.5 Check Error History! 9-16
 - 9.5.1 Trip History "Trip whole display" 9-16
 - 9.5.2 Retry History "Why retry history" 9-17
- 9.6 Copy Data! 9-18
 - 9.6.1 READ Function 9-18
 - 9.6.2 WRITE Function 9-19
- 9.7 System Settings! 9-20
- 9.8 Change Assist Bar Information! 9-22
- 9.9 Supplementary Information 9-23
- 9.10 Parameter Functions 9-24
 - 9.10.1 Protecting Parameters (Prohibiting Change) 9-24
 - 9.10.2 Limiting Displayed Parameters 9-25
 - 9.10.3 Saving Automatically Changed Parameters (User mode) 9-33
 - 9.10.4 Protecting Parameters by Password 9-34
 - 9.10.5 Checking the Parameters Changed from the Initial Value (Compare mode) 9-36
 - 9.10.6 Short menu function 9-37
 - 9.10.7 Motor setup function 9-38
- 9.11 Display Fixation Function 9-39
 - 9.11.1 Fixation of Display Using the DISP Terminal 9-39
- 9.12 Error Operation on the Operator Keypad 9-40
 - 9.12.1 Selection of Operation at Disconnection of Operator Keypad 9-40
 - 9.12.2 Display of Battery Level Warning 9-41
- 9.13 Prevention of Unnecessary Read/Write 9-42
 - 9.13.1 Disabling Data Read/Write 9-42

9.1 What This Chapter Explains

This chapter describes the operations of the keypad VOP (Viewable Operator Panel) and the the available functions.

When using the inverter, make sure to carefully read "Chapter 1 Safety Instructions/Risks" for safety work.

(Tips)



- I want to go back to the previous display without saving the parameter changes.
- I want to go back to the previous display.
- I want to go back to home display because I don't know what to do next.



- The cancel function is assigned to the F1 key. Press the F1 key to go back.



- For details, see the following sections.

Symbol	Meanings
	General and troubleshooting questions
	Key points for a solution
	Notes
	Confirmation of procedures

9.2 Start Operating the Inverter!

9.2.1 Operator Keypad and Icon Display



- I don't know how to use the operator keypad VOP.
- I don't understand what is shown on the window.



- The overview of the operator keypad is given below.
- * The color of the screen image may be different from the actual color.

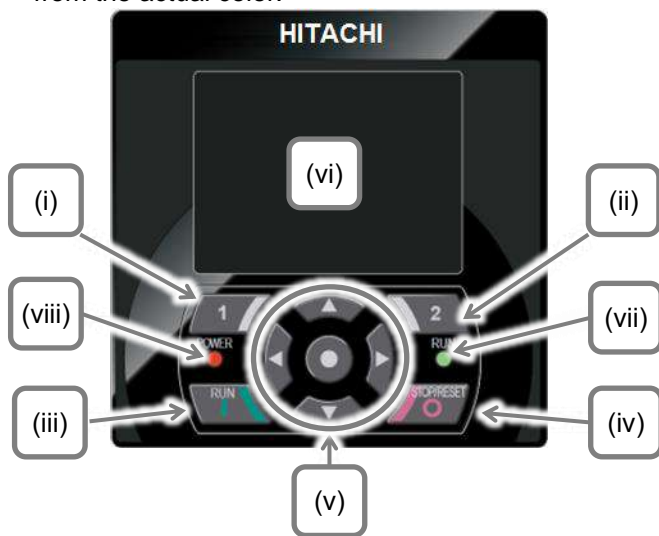

- About monitor screen (vi)

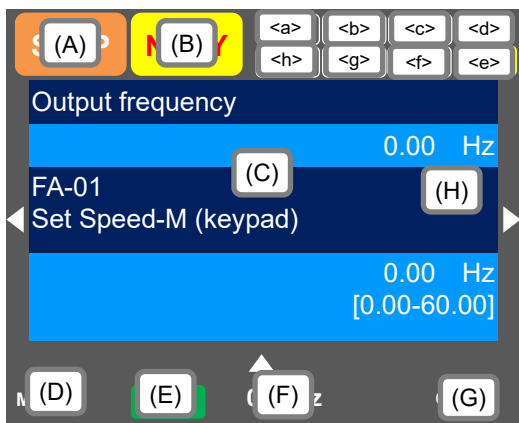

Note: If the screen is blackout, press any key to cancel it and enable operation. If the screen does not change after the operation, press the same key again.

No.	Name	Setting
(i)	F1 key	Transition to home, cancel, etc. Function of the key is indicated at the bottom left of the screen.
(ii)	F2 key	Save data, etc. Function of the key is indicated at the bottom right of the screen.
(iii)	RUN key	When this key is valid, press this key to start the motor.
(iv)	STOP/RESET key	The motor is decelerated and stopped. Or perform the trip reset of the inverter.
(v)	UP/DOWN/LEFT/RIGHT keys & SEL key (centre)	Use the Up/Down/Left/ Right keys to change the screen or select/change the data. Press the SEL key to determine the data selection.
(vi)	Monitor screen	Display the parameters and values, the inverter statuses, etc..
(vii)	RUN LED	Turns ON while RUN command is in execution.
(viii)	POWER LED	Turns ON while the keypad is powered-on. Also turns ON while power supply input to R0, T0 of the main circuit or P, P- of the terminal block.

No.	Description
(A)	Operation status.
(B)	Warning status.
(C)	Data/parameters.
(D)	Function assigned to F1 key.
(E)	Function of RUN key.
(F)	Frequency reference, Torque reference, Inverter Name, Clock, etc. When the F2 key function is "option", the display contents can be selected.
(G)	Function assigned to F2 key.
(H)	When soft-lock function is enabled, the [LKS] mark is displayed.

No.	Name	Description
<a>	Power status	Type of power supply (Input).
	SET function	SET terminal status for 1st/2nd motor setting.
<c>	Parameter	Parameter display mode.
<d>	Screen No.	Screen number.
<e>	STO function	Functional safety STO status.
<f>	Control mode	Control mode.
<g>	EzSQ	EzSQ program status.
<h>	Special status	Special function execution.

■ Sections of display screen on the operator keypad

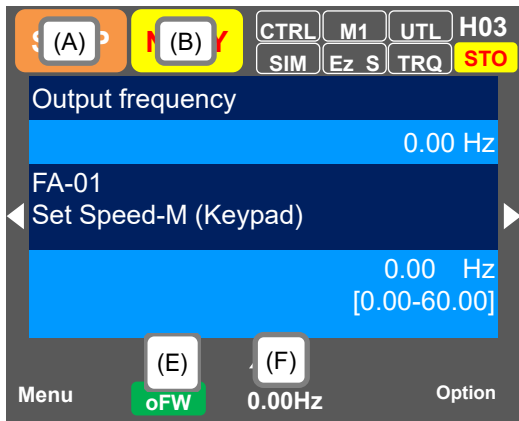

Display (A) Main Operation status display

No.	Indication	Description
A1		Displayed during normal rotation operation. There is a parameter that cannot be changed during operation.
A2		Displayed during reverse rotation operation. There is a parameter that cannot be changed during operation.
A3		Output is in process by 0Hz command. This is also displayed by DB, FOC, and SON functions. There is a parameter that cannot be changed during operation.
A4		Displayed during trip after the occurrence of error. For errors that cannot be canceled, perform reset operation to cancel. -> 18.3.1 Checking Trip Information
A5		Displayed when setting inconsistency occurs. It is cleared when the inconsistency is resolved. -> 18.5.2 Checking setting inconsistencies
A6		This is the stop display when the RUN command is being input but the output to the motor is shut off by a forced stop due to some function: <ul style="list-style-type: none"> • The RUN command was input when the frequency reference value is 0 Hz; • The inverter stopped by the Keypad STOP key when the RUN command is other than the Keypad; • The inverter stopped due to the output shutoff function such as [RS], [FRS] or etc., when the RUN command is other than the Keypad; • The inverter stopped by the Instantaneous power failure non-stop function. At this time, the RUN LED blinks.
A7		This is the stop display when there is no run command. <ul style="list-style-type: none"> • If the run command is the keypad RUN key, the inverter immediately enters this stop when the shutoff terminal functions are turned on.

(Tips)

- A6: If STOP (red),
- ⇒ When the display (F) is 0.00 Hz, the reference frequency is 0.00Hz. Make sure that the intended frequency reference is entered.
- ⇒ For example, the inverter is stopped by keypad STOP key while running by the input terminal [FW], the [FW] terminal must be turned off and then on again to start operation again.
- ⇒ The inverter cannot be driven if the output shutoff functions such as [RS] reset, [FRS] free-run, or STO terminal are ON.

Display (B) Warning status display

No.	Indication	Description
B1		While: <ul style="list-style-type: none"> • Overload restriction. • Torque limiting. • Overcurrent suppression. • Overvoltage suppression. • Upper or lower frequency limited. • Jump frequency limited. • minimum frequency limited. Details can be confirmed in [dC-37].
B2		This is displayed with the following functions: <ul style="list-style-type: none"> • Overload warning. • Motor thermal warning. • Inverter thermal warning. • Motor heat warning. Details can be confirmed in [dC-38].
B3		While waiting for retry or restart functions. Details can be confirmed in [dC-39].
B4		While inverter is in a state unfit to operate, even if a RUN command is issued. <ul style="list-style-type: none"> • Main power undervoltage. • Operating only with 24V supply. • Resetting. • Run command is not possible when the input terminal 101[REN](RUN enable) is assigned and it is OFF. Details can be confirmed in [dC-40].
B5		Cooling-fan life warning is issued. Also, the output terminal 030 [WAF] turned ON.
B6		Capacitor life warning is issued. Also, the output terminal 029[WAC] turned ON.
B7		When both Capacitor and Cooling-fan life warnings are issued.
B8	(None)	Different statuses from those shown above.

(Tips)

- LIM and ALT are indicated when current and internal voltage has risen. Review things such as the load if this error happens too often.
- Above icons are indicated when the cooling-fan and the electrolytic capacitors on the board lifespan has reached to the end.
- When [multi monitor],[While screen] or [Huge monitor], press the Up key (▲) to see the details of the warning.

Display (E) Keypad's RUN key function

No.	Indication	Description
E1		Forward operation from panel's RUN key.
E2		Reverse operation from panel's RUN key.
E3		By 023 [F-OP] Force operation or the keypad VOP or etc. functions, Keypad RUN key is forcibly enabled (>FW=Forward, >RV=Reverse)
E4		
E5	(None)	Different operation (other than RUN).

(Tips)

- When the keypad RUN key is enabled, E1 to E4 are displayed on (E).
- When checking the run command source or running from the keypad RUN key, first review the [AA111] RUN command input source selection. Alternatively, check the [dC-10] RUN command input source monitor.
- When "17: Remote mode switching" in the system settings is enabled, if the F1 key is held down for 1 second or longer on the home screen, the frequency reference source and RUN command source are forcibly switched to the keypad.

■ Sections of display screen on the operator keypad
(continue)

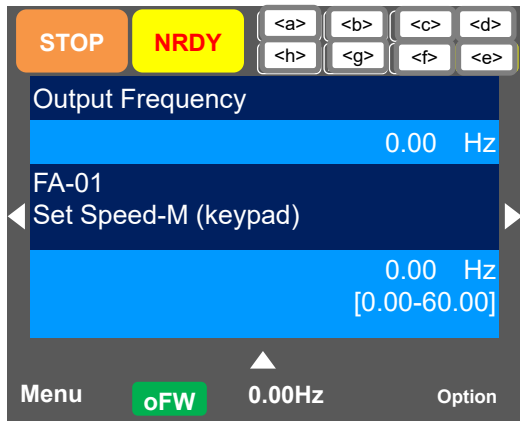

<a> Power status display

No.	Indication	Description
a1	(None)	Main and control power is supplied.
a2	CTRL	Control power supply is connected.
a3	24V	Only P+/P- 24V supply is connected.

(Tips)

- Indicates the power supply input status.
When CTRL or 24V is displayed, the inverter cannot be run because the main power supply is not input. Check the main power supply.

 [SET] function status

No.	Indication	Description
b1	M1	When input terminal 024[SET] is not assigned or is assigned but in OFF state (1st-motor is enabled).
b2	M2	Input terminal 024[SET] is assigned and in ON state (2nd-motor is enabled).

- When the input terminal 024[SET] is not being used, M1 is displayed.
If the centre character of the parameter is "-" (such as [AC-01]) or "1" (such as [AA111]) that parameter is valid, if it is "2" (such as [AA211]), it will be ignored. If the 2nd setting is valid, Output terminal 012[SETM] 2nd control selected becomes ON.

<c> Parameter display

No.	Indication	Description
c1	(None)	Display all modes.
c2	UTL	Individual function display mode.
c3	USR	User's settings display mode.
c4	CMP	Data comparator display mode.
c5	MON	Only monitor display mode.

(Tips)

- It is displayed if it operating under a display limiting function. Change the setting of [UA-10] in the case that the parameters are not being displayed.

<d> Monitor screen number

(Tips)

- Each screen displayed has a number. When contacting to us, make reference to the screens with its number.

<e> Functional safety

(Tips)

- If there is any indication, the inverter is in the cut-off state.

For details, refer to "21.4 STO Terminal Functions".
(Refer to the separate volume "SJ Series P1 Safety function Guide" (NT2512*X) for more details.)

<f> Control mode

No.	Indication	Description
f1	(None)	Speed control mode.
f2	TRQ	Torque control mode.
f3	POS	Position control mode.

(Tips)

- This display shows the control mode.

<g> EzSQ mode

No.	Indication	Description
g1	(None)	EzSQ not selected.
g2	Ez_S	EzSQ programme not running.
g3	Ez_R	EzSQ programme running.

(Tips)

- This display shows the operation status of the EzSQ function.

<h> Display of special function status

No.	Indication	Description
h1	(None)	The inverter is not in the special status.
h2	AUT	The inverter is auto-tuning.
h3	SIM	The inverter is in the simulation mode.

(Tips)

- If the function is displayed, it means that the inverter is in the special state.

■ List of monitor screen numbers

No	Name	Screen number
1	Three-line monitor screen "Multi monitor"	H01
2	Setting screen for rotating direction of operator keypad	H02
3	Setting screen "While screen"	H03
4	Monitor with large characters "Huge monitor"	H04
5	Selection screen for parameter code	H05
6	Trip history "Trip whole display"	H06
7	Trip currently occurring	H07
8	Detailed trip history screen	H08
9	Retry history "Why retry history"	H09
10	Detailed retry history screen	H10
11	Detailed screen for limitation status icon	H11
12	Home screen option	o01
13	Inverter name setting	o02
14	Selection of data displayed at the bottom center	o03
15	Menu screen	M01
16	R/W function screen	R01
17	Screen for selecting data uploaded using the R/W function	R02
18	Screen for selecting saving location for data uploaded using the R/W function	R03
19	Screen for displaying progress status of uploading using the R/W function	R04
20	Screen for selecting data downloaded using the R/W function	R05
21	Screen for selecting the location for reading data that is downloaded using the R/W function	R06
22	Screen for displaying progress status of downloading using the R/W function	R07
23	System settings screen	S01
24	Language selection screen	S02
25	Dimming setting screen	S03
26	Setting screen for automatic light off time	S04
27	Setting screen for dimming at light off	S05
28	Setting screen for automatic home transition time	S06
29	Monitor screen for basic inverter information	S07
30	Selection screen for operator initialization	S08
31	Operator version display screen	S09
32	Date and time screen	S11
33	Date and time setting screen	S12
34	Selection screen for date and time display format	S13
35	Setting screen for battery level warning	S14
36	Inverter model selection screen	S19
37	Read lock selection screen	S21
38	Selection screen for blinking at the time of trip	S22
39	Color setting screen	S23

No	Name	Screen number
40	Selection screen for self-check mode	S25 ~S35
41	Setting screen for automatic home screen	S36
42	Remote mode switching screen	S38
43	Scroll menu	L01
44	Scroll screen	L02
45	User mode screen *2)	L04
46	Short menu screen *2)	L04
47	Compare mode screen *2)	L03
48	Motor setup screen *2)	L04
49	Message screen	*1)

*1) If a message is displayed, see "18.5.3 Checking Display Messages".

*2) These are functions added in Ver2.02.

9.2.2 Transition of Operator Keypad Screen

· Types of main monitor screen



· Menu screen

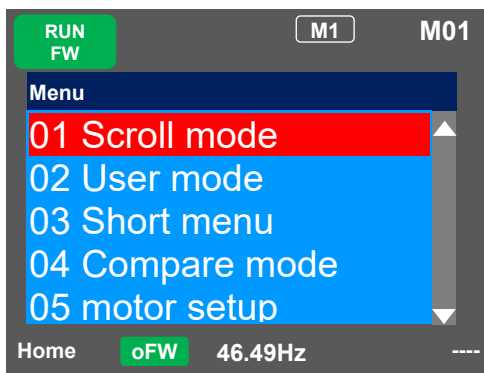

· Home screen option

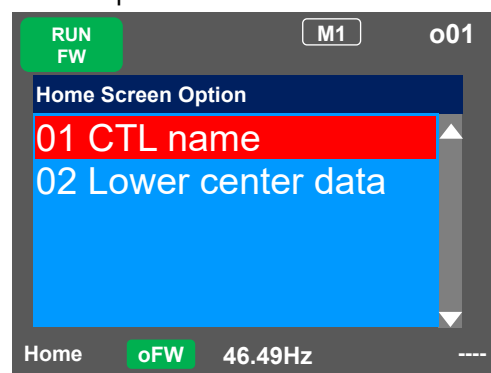

· To switch to the "Menu screen", press "F1(1)" key when "Menu" is displayed on the main monitor screen.
(Note: 02 to 05 functions are added in Ver2.02)



· To switch to the "Home Screen Option", press "F2(2)" key when "Option" is displayed on the main monitor screen.
To return to the main monitor screen, press F1(1) key.

9.3 Let's Set Up the Parameters!

9.3.1 Checking the List and Configuring "Scroll Mode"



- I want to first configure settings to rotate the motor.
- To configure inverter settings, I want to change parameters.
- I want to check parameter settings all at once.



- Press F1 (Menu) key on the screen that is displayed upon power-on ("Multi monitor" in the example below) to move to the system settings screen (M01).



- When configuring basic settings of motor, base frequency, rated voltage of motor, input and output of terminals, as well as when configuring individual functions, change parameters in the scroll mode.
- You can check list of setting data of parameters in the scroll mode, therefore, it is also useful when checking the settings.
- In the system settings, if the scroll screen is set to the initial screen, dA-01, dA-02, and dA-03 of the d: Monitor are initially displayed.

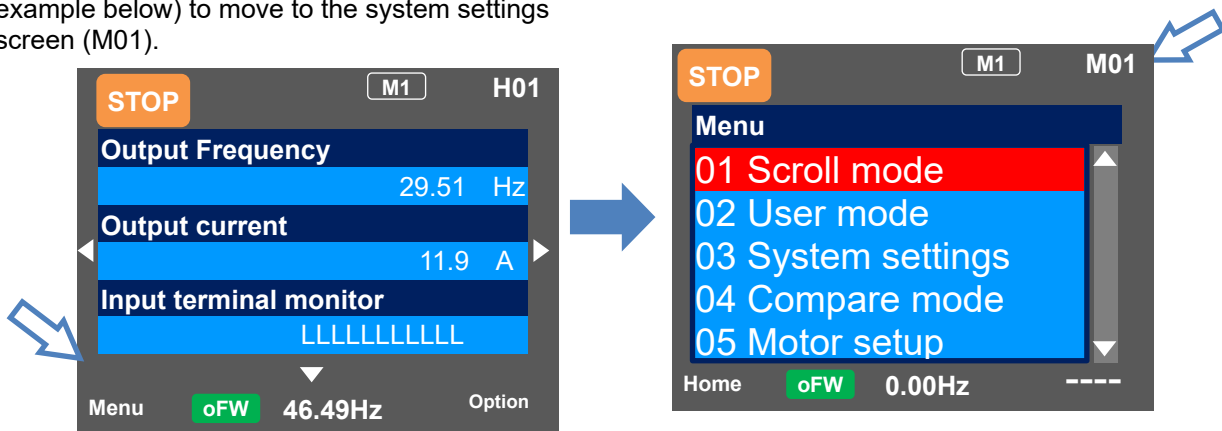

(Note: 02 to 05 function is added from Ver2.02)

Scroll menu - Parameter selection screen

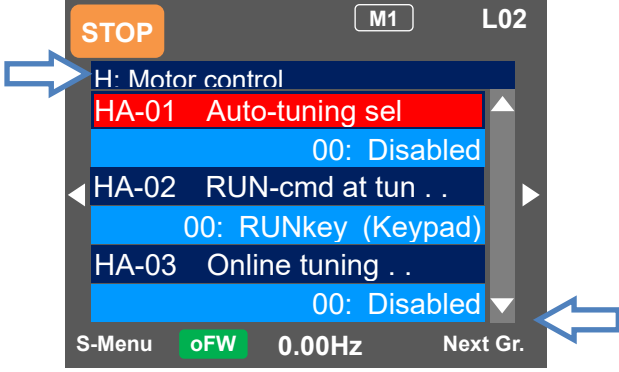
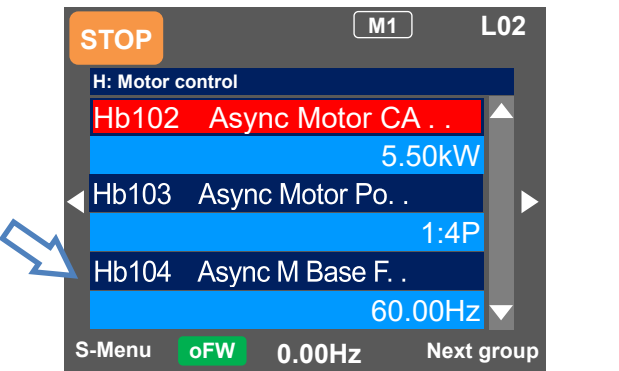

Set-up procedure	Action
	<p>3.1.1 Choose the scroll mode on the system settings screen (M01) and press the SEL(O) key to show the scroll menu (L01). ⇒ Go to 3.1.2.</p>
	<p>3.1.2 Choose a group you want to browse using the up and down (Δ▽) keys, and then press the SEL(O) key to move to the parameter list display. For example, select "H: Motor control".</p> <p>Example: In the example shown below, the Hb group, which is a basic parameter of induction motor, is checked, and a parameter is changed. ⇒ Go to 3.1.3</p>

Set-up procedure	Action
	<p>3.1.3 Parameters of "H: Motor control" are displayed. Using the up and down ($\Delta\nabla$) keys, you can check parameters. Pressing the F2(2) key jumps to the top [Hb102] of the next sub-group of [HA]. ⇒ Go to 3.1.4</p> <p>(Tips) You can jump to the top parameter of the sub-group in the group ([HA], [Hb], etc. in the case of group H) using the F2(2) key (transition is performed in one direction).</p> <p>Example of group H: ...->HA->Hb->HC->Hd->HA->...</p>
	<p>3.1.4 Using the up and down ($\Delta\nabla$) keys, you can check parameters. Choose the parameter to change, and then press the SEL(O) key.</p> <p>Example1) [Hb103] The parameter to change the "Async. Motor number of poles setting, 1st-motor". ⇒Go to 3.1.5</p> <p>Example2) [Hb104] The parameter to change the "Async. Motor base frequency setting, 1st-motor". ⇒Go to 3.1.7</p>

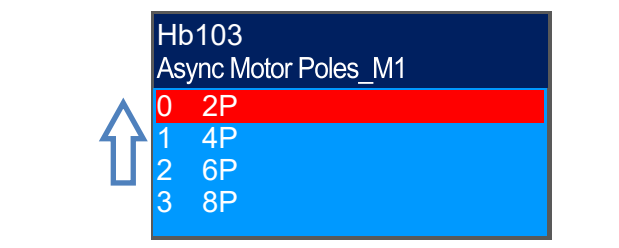
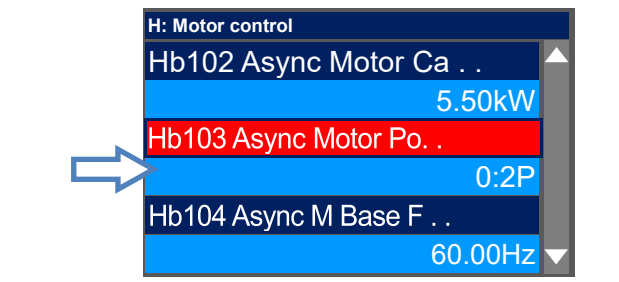
Example1) Change [Hb103] Async. Motor number of poles setting, 1st-motor

Set-up procedure	Action
	<p>3.1.5 If the number of motor poles is 2, using the up and down ($\Delta\nabla$) keys, adjust it to "0 2P", and then press the F2(Save) key.</p> <p>(Tips) Data is saved when the F2(2) key is pressed. It is saved even when the power is turned off because volatile memory is used. When configuring an item, the entire screen changes to the screen for setting the item. When not saving the setting after changing it, press the F1(Back) key. The screen returns to the parameter list display.</p>
	<p>3.1.6 To confirm if the data is correctly changed, check the lower section of the parameter display. Press the F1(1) key three times to return to the monitor.</p>

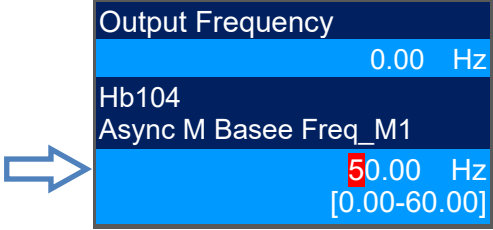
Example2) Change [Hb104] Async. Motor base frequency setting, 1st-motor.

Set-up procedure	Action
	<p>3.1.7 You can change the Left-most digit of data area. Change the value using the arrow ($\Delta \nabla \leftarrow \rightarrow$) keys, and then press the F2(2) key. ⇒Go to 3.1.8</p> <p>(Tips) In the figure on the left, base frequency is changed to 50.00Hz. Data is saved when the F2(2) key is pressed. It is saved even when the power is turned off because volatile memory is used. You can make adjustments while performing monitoring. The monitor on the upper area shows the parameter selected in the "Huge monitor".</p>
	<p>3.1.8 To confirm if the data is correctly changed, check the lower section of the parameter display. Press the F1(1) key three times to return to the monitor.</p>



- In the scroll mode screen (L02), (i) you can jump to the parameter at the top of each group by using the right and left (◀▶) keys or (ii) jump to the parameter at the top of the sub-group (AA, Ab, etc.) of the group by using F2(Next group) key.

- (i) You can jump to the top parameter of each group by using the right and left (◀▶) keys.
 (... <->All parameters<->d: Monitor<->F: Command monitor/setting<->... <->U: Initial setting, PDN<-> All parameters<->...)
- (ii) You can jump to the top parameter of the sub-group in the group (AA, Ab, etc.) using the F2(Next group) key (transition is performed in one direction (see below)).
 • Example of group A: ... ->AA->Ab->AC->... ->AJ->AA->...

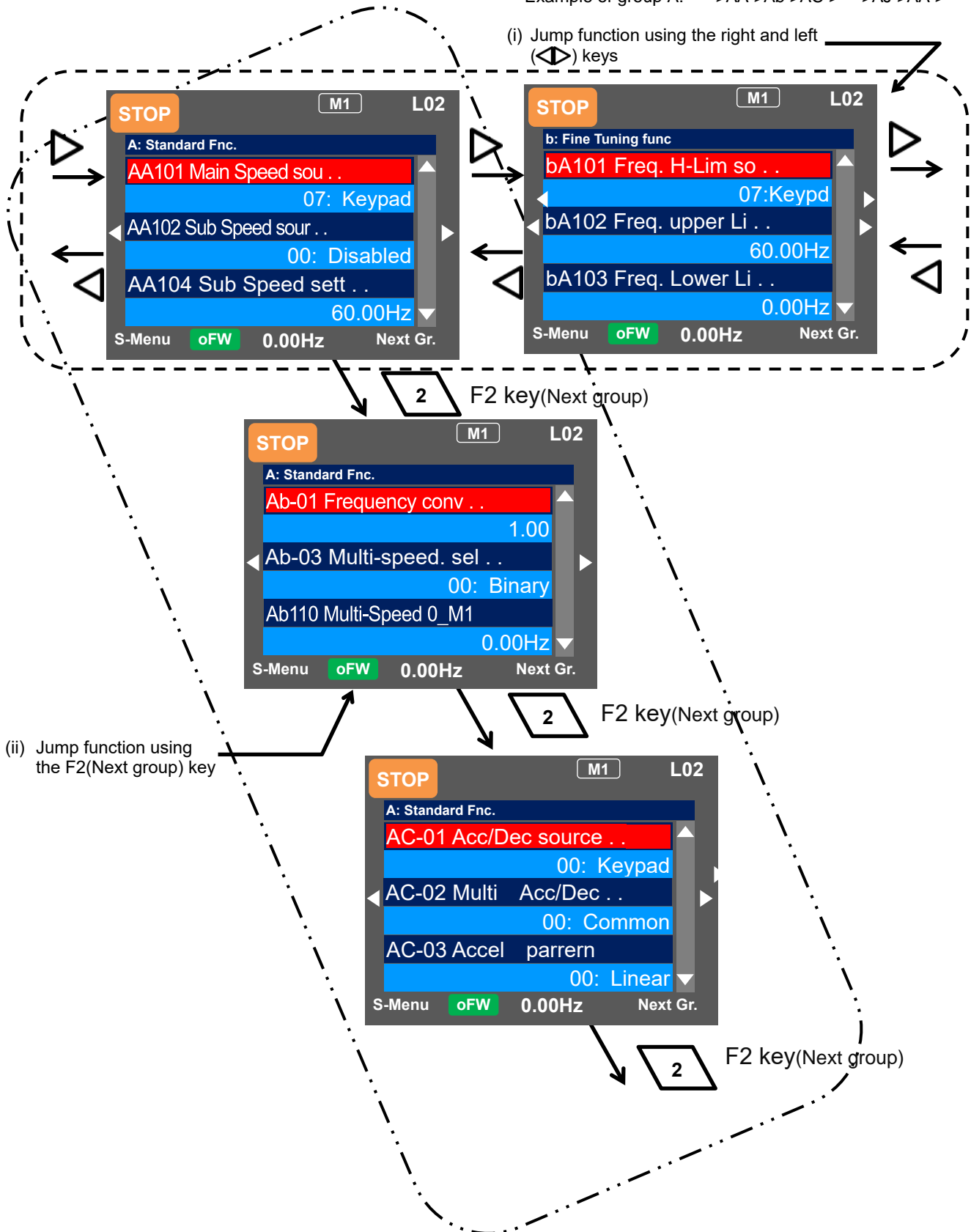

9.3.2 Changing a Parameter While Watching a Monitor "While screen"



- To control the inverter operation, I want to change a parameter while monitoring the operation.



- On the screen that is displayed upon power-on, using the right and left (◀▶) keys, navigate to a setting screen "While screen" (H03).

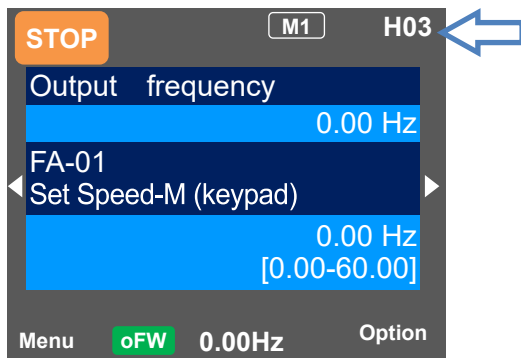

- When configuring settings such as the frequency reference and acceleration/deceleration time while watching the monitor during operation, you can change the settings on this monitor screen.
- On the setting screen "While screen", you can change parameters while watching the monitor. For details of the monitor, see "9.4.2 Setting Screen "While screen".



- In the case of a parameter that requires selection of an item, the screen changes to the item selection screen.

Monitor screen - Parameter selection screen

Set-up procedure	Action
	<p>3.2.1 Press the SEL(O) key to change the color of parameter field. ⇒Go to 3.2.2</p> <p>(Tips) Using the up and down (Δ▽) keys, you can choose to change the parameter or change the monitor.</p>
	<p>3.2.2 When the SEL(O) key is pressed again, the left-most letter of the parameter can be changed. ⇒Go to 3.2.3</p>
	<p>3.2.3 Using the arrow (Δ▽◀▶) keys to change the parameter code that you want to change, and then press the SEL(O) key.</p> <p>Example1) When the frequency reference source [AA101] "Main speed input source selection, 1st-motor" is changed. ⇒Go to 3.2.4</p> <p>Example2) When the frequency reference value is controlled in [FA-01] while the frequency reference source is set to "07:Keypad". ⇒Go to 3.2.7</p>

Example1) Change the [AA101] "Main speed input source selection, 1st-motor" to [Ai1] terminal.

* The [Ai1] terminal is an analog input terminal (voltage/current).

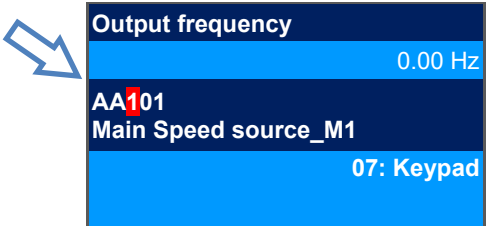
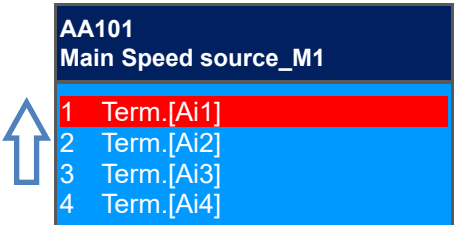
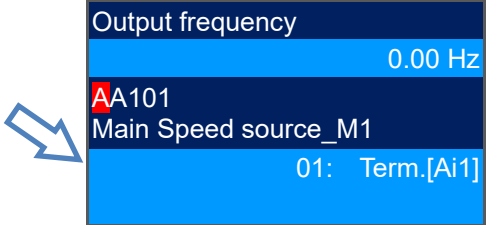
Set-up procedure	Action
	<p>3.2.4 Press the SEL(O) key while [AA101] is displayed. ⇒Go to 3.2.5</p> <p>(Tips) The information currently selected is shown in the lower section. "07: keypad" is currently selected.</p>
	<p>3.2.5 Use the up and down (Δ∇) keys to select "1 Term.[Ai1]", and then press the F2(2) key. ⇒Go to 3.2.6</p> <p>(Tips) Data is saved when the F2(2) key is pressed. It is saved even when the power is turned off because volatile memory is used. When configuring an item, the entire screen changes to the screen for setting the item.</p>
	<p>3.2.6 To confirm if the data is correctly changed, check the lower section. Press the F1(1) key to return to the monitor.</p> <p>(Tips) The information currently selected is shown in the lower section. Currently, "01 Term.[Ai1]" is selected.</p>

Example2) Change frequency reference in [FA-01].
(If the Main speed input source selection is "07: Keypad")

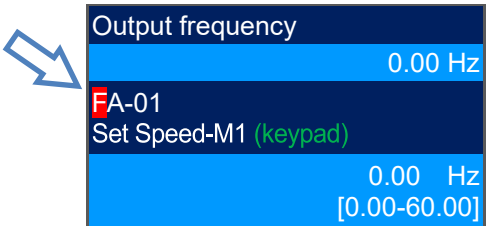
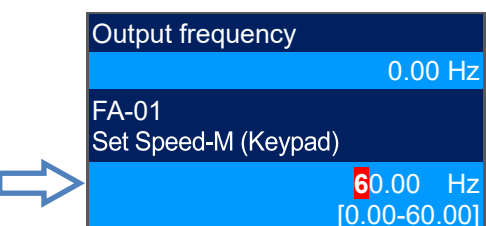
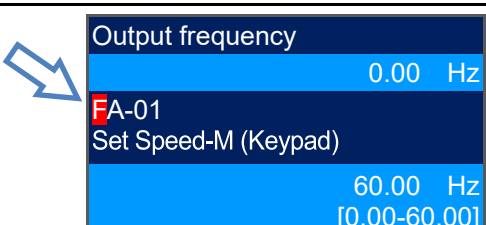
Set-up procedure	Action
	<p>3.2.7 Press the SEL(O) key while [FA-01] is displayed. ⇒Go to 3.2.8</p> <p>(Tips) In [FA-01], the set value can be changed if the string inside () of main speed reference indicates the operator keypad or multi-stage speed. In other cases, it is reference monitor.</p>
	<p>3.2.8 You can change the left-most digit of data. Change the value using the arrow (Δ∇◀▶) keys, and then press the F2(2) key. ⇒Go to 3.2.9</p> <p>(Tips) In the figure on the left, base frequency is changed to 60.00Hz. Data is saved when the F2(2) key is pressed. It is saved even when the power is turned off because volatile memory is used. You can make adjustments while performing monitoring.</p>
	<p>3.2.9 To confirm if the data is correctly changed, check the lower section. Press the F1(1) key to return to the monitor.</p> <p>(Tips) The current frequency reference is shown in the lower section. Currently, 60.00Hz is input as the reference.</p>

9.4 Monitor Inverter Information!

9.4.1 Three-Line Monitor Screen "Multi monitor".



· I want to monitor multiple data at the same time.



· What is displayed on the first line of three-line monitor screen "Multi monitor" (H01) is the same as that displayed on the upper area of the setting screen "While screen" (H03) and the screen with large characters, "Huge monitor" (H04).



· On the screen that is displayed upon power-on, using the right and left (◀▶) keys, navigate to "H01".



· In the three-line monitor screen, you can monitor three types of information at the same time. You can change and save the monitored data.

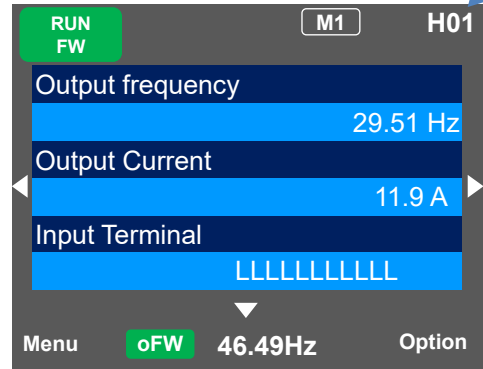

Example) Change the output current monitor to the input power monitor.

Set-up procedure	Action
	4.1.1 Press the SEL(O) key to change the color of the field in upper section. Use the up and down (Δ▽) keys to navigate to the second line. ⇒ Go to 4.1.2
	4.1.2 When the SEL(O) key is pressed, the left-most letter of the parameter can be changed. ⇒ Go to 4.1.3
	4.1.3 Use the arrow (Δ▽◀▶) keys to change [dA-02] to [dA-30]. ⇒ Go to 4.1.4
	4.1.4 Press the SEL(O) key to confirm the monitoring target. Press the F1(1) key to return to the monitor.

9.4.2 Setting Screen "While screen"



· I want to change the monitor used when changing a parameter while performing monitoring.



· What is displayed on the upper monitor of the setting screen "While screen" (H03) is the same as that displayed on the first line of three-line monitor screen "Multi monitor" (H01) and the screen with large characters, "Huge monitor" (H04).



· From the screen that is displayed upon power-on, use the right and left (◀▶) keys to navigate to "H03".



· On the setting screen, you can control parameter data while performing monitoring. To change the selected data, the screen changes to the setting screen that shows options.

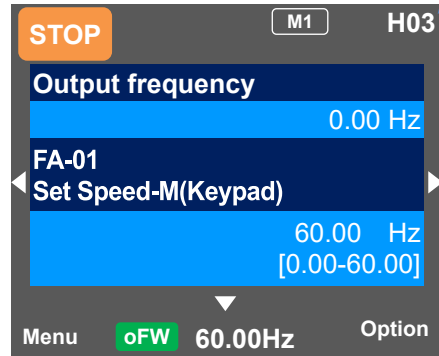

Example) Change the output frequency monitor to the PID1 output monitor.

Set-up procedure	Action
	4.2.1 Press the SEL(O) key to change the color of parameter field. Use the up and down (Δ∇) keys to select and navigate to the detail of monitoring. ⇒Go to 4.2.2
	4.2.2 When the SEL(O) key is pressed, the left-most letter of the parameter can be changed. ⇒Go to 4.2.3
	4.2.3 Use the arrow (Δ∇◀▶) keys to change [dA-01] to [db-50]. ⇒Go to 4.2.4
	4.2.4 Press the SEL(O) key to confirm the monitoring target, which is then displayed in the upper section. Press the F1(1) key to return to the monitor. You can also configure parameters using the up and down (Δ∇) keys .

9.4.3 Monitor with Large Characters
"Huge monitor"



· I want to perform monitoring with numeric values displayed in larger size.



· In the monitor screen with large characters, you can display a parameter in bigger size.



· What is monitored on the screen with large characters, "Huge monitor" (H04) is the same as the upper monitor of the setting screen "While screen" (H03) and the first line of three-line monitor screen "Multi monitor" (H01).



· From the screen that is displayed upon power-on, use the right and left (◀▶) keys to navigate to "H04".

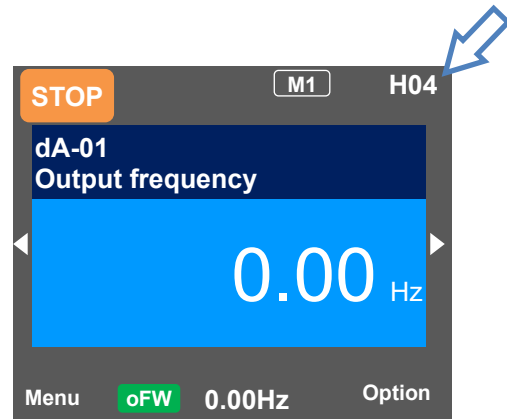

Example) Change the output frequency monitor to the integrated input power monitor.

Set-up procedure	Action
	4.3.1 When the SEL(O) key is pressed, the left-most letter of the parameter can be changed. ⇒Go to 4.3.2
	4.3.2 Use the arrow (Δ▽◀▶) keys to change [dA-01] to [dA-32]. Press the SEL(O) key to confirm and return to the monitor.

9.5 Check Error History!

9.5.1 Trip History "Trip whole display"



• I want to check trip history.



- To display the "date and time" in trip history, you need to configure clock settings.
- To use the clock function, you need an optional battery that is separately sold.
- For details, refer to "No.09 Date and time" in chapter "9.7 System Settings!".



• From the screen that is displayed upon power-on, use the right and left (◀▶) keys to navigate to "H06".



- The trip history screen " Trip whole display" shows details of the errors that have occurred and the total number of times trip occurred.
- For details of errors, see "Chapter 18 Tips/FAQ/Troubleshooting".

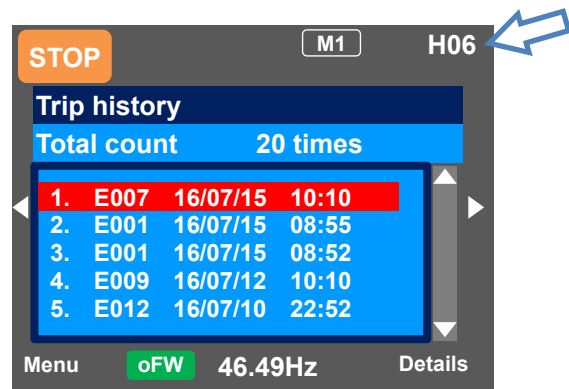

Set-up procedure	Action
	5.1.1 Use the up and down (Δ∇) keys to select history information you want to check. ⇒Go to 5.1.2
	5.1.2 Press the SEL(O) key to show details of the selected history information. ⇒Go to 5.1.3
	5.1.3 By using the up and down (Δ∇) keys, you can check the details. Press the F1(1) key to return to the monitor.

9.5.2 Retry History "Why retry history"



· I want to check retry history.



- To display the "date and time" in retry history, you need to configure clock settings.
- To use the clock function, you need an optional battery that is separately sold.
- For details, refer to "No.09 Date and time" in chapter "9.7 System Settings!".



· From the screen that is displayed upon power-on, use the right and left (◀▶) keys to navigate to "H09".



- The retry history screen "Why retry monitor" shows details of the errors that have occurred and the total number of times retry was performed.
- For details of errors, see "Chapter 18 Tips/FAQ/Troubleshooting".

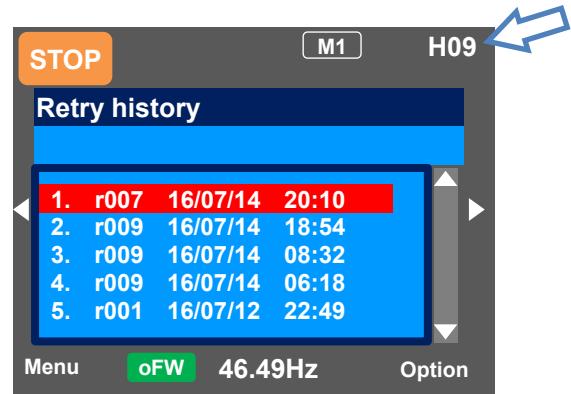

Set-up procedure	Action
	5.2.1 Use the up and down (Δ▽) keys to select history information you want to check. ⇒Go to 5.2.2
	5.2.2 Press the SEL(O) key to show details of the selected history information. ⇒Go to 5.2.3
	5.2.3 by using the up and down (Δ▽) keys, you can check details. Press the F1(1) key to return to the monitor.

9.6 Copy Data!

9.6.1 READ Function



- I want to back up inverter data on the operator keypad just in case.
- I want to retrieve data to migrate settings to another inverter.



- On the screen that is displayed upon power-on, press the F1(1) key to navigate to the menu screen "M01". Then, select the "06 Read/Write" by pressing the SEL(O) key.



- With Read/Write function, you can read and write data.
- Only a set of data can be saved.



Set-up procedure	Action
	6.1.1 Press the SEL(O) key to confirm the READ function. ⇒Go to 6.1.2
	6.1.2 Select data to be read by using the up and down (Δ∇) keys. Then, confirm the function by pressing the SEL(O) key. ⇒Go to 6.1.3
	6.1.3 In accordance with the instruction shown on the screen, specify the location of data you to be saved, and press the F2(2) key to navigate to the confirmation screen. Then, press the F2(2) key to start reading the data. When the completion screen appears, the procedure is complete. Display description: No, Date and time, Inverter name, Unique No,Data type * Inverter name and Unique No are fixed for SJ-P1. * Data type is 1: Only parameters or 2: Parameters+EzSQ. * To display Date and time, you need to configure clock settings from System settings.

* If you cannot read data, see "9.13.1 Disabling Data Read/Write".

(Note: 02 to 05 function is added from Ver2.02)

9.6.2 WRITE Function



- I want to write data to migrate settings to another inverter.
- I want to rewrite data that was read.



- On the screen that is displayed upon power-on, press the F1(1) key to navigate to the menu screen "M01". Then, select the Read/Write function by pressing the SEL(O) key.



- With Read/Write function, you can read and write data.

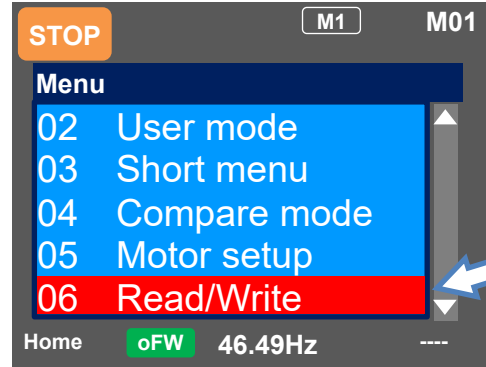

Set-up procedure	Action
	<p>6.2.1 Select the write function by using the up and down ($\Delta$$\nabla$) keys. Then, confirm by pressing the SEL(O) key. ⇒Go to 6.2.2</p>
	<p>6.2.2 Select data to be written by using the up and down ($\Delta$$\nabla$) keys. Then, confirm the function by pressing the SEL(O) key. ⇒Go to 6.2.3</p>
	<p>6.2.3 In accordance with the instruction shown on the screen, select data to be written to the inverter, and press the F2(2) key to start writing. When the completion screen appears, the procedure is complete.</p> <p>Display description: No, Date and time, Inverter name, Unique No,Data type * Inverter name and Unique No are fixed for SJ-P1. * Data type is 1: Only parameters or 2: Parameters+EzSQ. * To display Date and time, you need to configure clock settings from System settings.</p>

* If you cannot write data, see "9.13.1 Disabling Data Read/Write".

(Note: 02 to 05 function is added from Ver2.02)

9.7 System Settings!



- I want to change settings of the operator keypad.
- I want to initialize settings of the operator keypad.



- On the screen that is displayed upon power-on, press the F1(1) key to navigate to the menu screen "M01". Then, select the "07 System setting" by pressing the SEL(O) key.

No.	Name	Tips
01	Language selection	Changes the language setting.
02	Dimming	Controls the brightness of operator keypad screen.
03	Automatic light off time *1)	Controls the time to automatically light off the screen.
04	Dimming at light off *1)	Controls the brightness when the screen is automatically lit off.
05	Automatic home transition time	Sets the time to automatically return to the home screen.
06	Initial home screen selection	Sets the screen that is displayed upon power-on and automatic return to the home screen. When the input terminal function 102 [DISP] is turned ON, the screen set here is fixed.
07	Read lock	Limits the reading of data.
08	Blinking during trip	Sets whether blinking is performed or not during trip.
09	Date and time*2)	Configures settings of time, display format, and battery level warning.
10	Battery level warning	Displays a warning message when the battery runs out.
11	Color setting	Sets the background color.
12	Basic inverter information monitor	Checks information of the main unit.
13	Selection of connected model	Sets SJ-P1.
14	Operator keypad version	Displays the version of the operator keypad.
15	Initialization of operator keypad	Initializes the operator keypad.
16	Self-check mode	Operates self-check mode.
17	Remote mode switching	If this setting is enabled, when the F1 key on the home screen is pressed for 1 second or more, the frequency reference and RUN command can be switched to input from the operator keypad.
18	Reserve	Do not change the setting from OFF.

*1) The light off function (No.03) is disabled until trip is canceled after the occurrence of trip.

*2) To use the clock function, you need an optional battery that is separately sold.
 Recommended product: Maxell, Ltd. CR2032, 3V
 If no electricity is supplied to the inverter, battery replacement is required every two years.



- On the System settings screen, you can use extended functions.

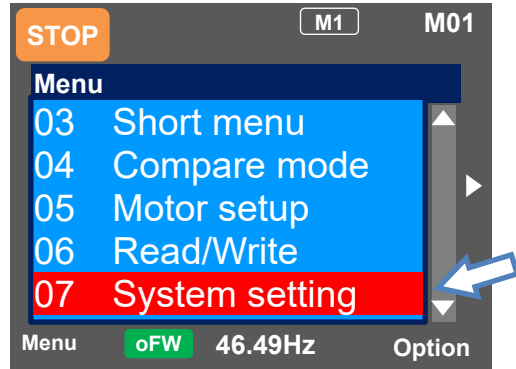

(Note: 02 to 05 function is added from Ver2.02)



- If there is an error in the memory area in the operator keypad, an error message is displayed on the operator keypad. In such a case, initialize the operator keypad from the System settings, and confirm the settings. If the error on the operator keypad is not solved, the internal memory may be damaged. You need to replace the operator keypad.

Battery replacement of the operator keypad VOP



- The battery used for clock function is not included with this inverter. Prepare CR2032 as necessary.
- When battery is changed, the clock data is initialized, therefore, you need to configure the setting again.
- Even if the battery runs out, data in VOP (read parameters and EzSQ program) are retained.

Disposal of battery of the operator keypad VOP



- Disposal of the operator keypad VOP or battery that is no longer needed may subject to regulations of your municipalities. Dispose of them in accordance with regulations of respective municipalities. Insulate the battery using a tape or other materials when disposing of it.



- Care must be taken in export of an operator keypad VOP equipped with a battery.
- When products equipped with lithium primary battery (including all manganese dioxide lithium coin batteries and heat-resistant manganese dioxide lithium coin batteries) are exported to or transferred via California in the U.S., it is obliged to mark the following sentences in the packaging case, individual packages, and instruction manuals.

Perchlorate Material - special handling may apply.
See www.dtsc.ca.gov/hazardouswaste/perchlorate

- When you export your products equipped with the operator keypad VOP to California in the U.S., please mark the indications shown above on the packaging case such as external box and transportation box of your product.



- Follow the following steps to replace the battery.
 - (i) Check the inverter is turned off and the POWER LED on the operator keypad is off.
 - (ii) Remove the operator keypad VOP from the main unit. When removing the operator keypad, hold the front cover.
 - (iii) Open the cover of the operator keypad VOP, which is on the back side, and then insert the battery. Make sure that you can see the + side when inserting the battery.
 - (iv) Close the cover, and install the operator keypad VOP in the inverter again.



DANGER



Prohibited



Do

- As batteries are subject to leakage, explosion, heat generation, and fire, do not short circuit + and - terminals, charge, disassemble, heat, expose to fire, or apply a strong impact.
- If a strong impact is accidentally applied to them (e.g., dropped on the floor), do not use the battery because they may have leakage.
- It is defined by the UL standard that battery replacement must be performed by a skilled technician. Please assign a skilled technician to perform the replacement work.
- If you cannot see what is displayed on the operator keypad VOP because the service life is near its end, replace the operator keypad VOP.

9.8 Change Assist Bar Information!



- I want to change the frequency reference displayed on the assist bar to inverter name.
- I want to display current time on the assist bar.



- From the screen that is displayed upon power-on, press the F2(2) key to navigate to the option screen "o01". Then, select data that is shown at the bottom center by pressing the SEL(O) key. After selecting data, save it by pressing the F2(2) key.



- By selecting the F2(2) key option from the home screen, you can change the content of display of assist bar.

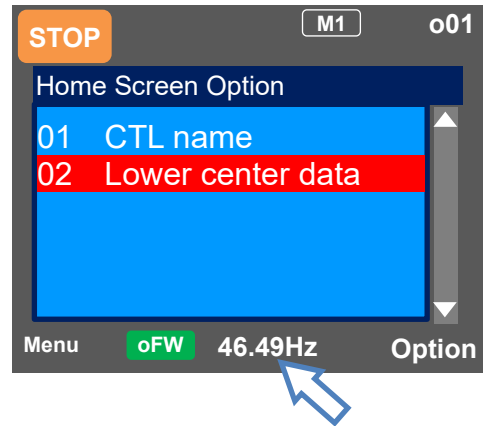

Option		Tips
01 CTL name (Inverter name)		You can specify 8-digit string from alphanumeric letters and symbols.
02 Lower center data (The data that displayed at the bottom center)	00 Set Frequency	The current frequency reference is displayed.
	01 Set Trq-Ref	The current torque reference is displayed (during torque control).
	02 Clock	The current time is displayed.
	03 CTL name	The specified controller (inverter) name is displayed.

9.9 Supplementary Information

■ Back to the home monitor



- I want to go back to the home monitor.



- Press the F1 key repeatedly to go back to the home monitor. When home is shown above the F1 key, you can go back to the home monitor, and navigate through the home monitor using the right and left keys.

■ Display (B) Details of warning status display



- I see icons with "NRDY", "LIM", and "ALT", but I don't know what they mean.



- When the up key is pressed while a monitor screen other than the trip history "Trip whole display" is displayed, the screen changes to the monitor where you can check the current status. Press the SEL(O) key, down key, and F1 key to go back.

■ I want to delete saved data that I read.



- I want to delete saved data that I read using the read function.



- By performing initialization of the operator keypad on the System settings screen, you can delete data that is saved using the read function. However, note that the settings of the operator keypad are also initialized.

■ Switch between Forward / Reverse rotations on the operator keypad



- I want to easily switch between forward rotation and reverse rotation using the operator keypad.



- Pressing the down key when the "Multi monitor", which is a 3-line monitor screen, is displayed, the screen shown below appears. The direction of rotation can be specified with the F1 (1) key (forward rotation) or F2 (2) (reverse rotation). The white character display on the blue background is the current rotation direction. Press the Up key to return to "Multi Monitor".

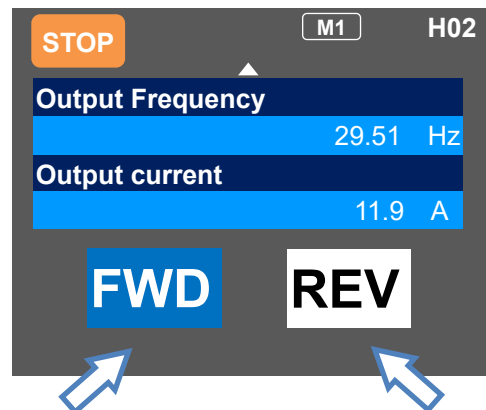

Forward rotation by pressing the F1 (1) key

Reverse rotation by pressing the F2 (2) key

Forward rotation, which is the white character and blue background, is the current rotation direction.



- When using this function, be careful not to drive the motor in the unintended rotation direction due to erroneous operation.

9.10 Parameter Functions

9.10.1 Protecting Parameters (Prohibiting Change)



- I want to protect a parameter value that I changed.
- I do not want anyone to change the setting without permission.



- By configuring the soft-lock function [UA-16] and [UA-17], you can prevent parameters from being changed.
- While soft-lock function is enabled, the LKS mark (Lock State mark) is shown on the right of parameters.

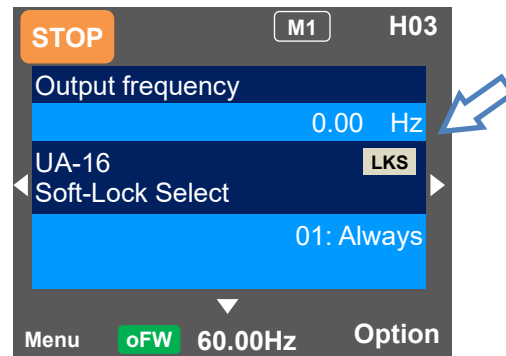

Parameter

Name	Code	Data range (unit)	Description
Soft-lock selection	[UA-16]	00	When the soft lock terminal [SFT] is ON, the parameters depending on the [UA-17] setting cannot be changed.
		01	After setting this parameter to 1, the parameters depending on the [UA-17] setting cannot be changed.
Soft-lock target selection	[UA-17]	00	All data other than [UA-16] and [UA-17] cannot be changed.
		01	Other data cannot be changed except for [UA-16], [UA-17] and frequency reference data.
Input terminal function	[CA-01] to [CA-11]	036	[SFT]: Used when the soft-lock function is used on terminals.

9.10.2 Limiting Displayed Parameters

Q

- I want to display only the necessary parameters.
- I want to hide parameters not in use as much as possible.
- I want to display only parameters that have been changed.

A

- You can change the content of display on the operator keypad according to your purpose.
- To know which parameters are changed, you can check by setting [UA-10] to 03.
- If you do not want to display parameters for functions not in use, you can reduce them by setting [UA-10] to 01.

Parameter

Name	Code	Data range (unit)	Description
Display restriction selection	[UA-10]	00	All parameters are displayed.
		01	Parameters are displayed by function. Disabled functions are not displayed with some exceptions.
		02	Display is performed in accordance with the settings configured by the user. Parameters set to [UA-31] to [UA-62] are displayed with some exceptions.
		03	Parameters that have been changed from the factory default settings and some other parameters are displayed.
		04	Monitor parameters and some other parameters are displayed.
2nd-motor parameter display selection	[UA-21]	00	Hides parameters of second setting [**2**].
		01	Displays parameters of second setting [**2**].
Option parameter display selection	[UA-22]	00	Hides parameters that codes are [o*-*].
		01	Displays parameters that codes are [o*-*].
User-parameter 1 to 32 selection	[UA-31] to [UA-62]	no	No assignment
		*****	Choose the code you want to display. (Parameters other than [UA-31] to [UA-62] are subjected)

A

- If you are not using the input terminal function [SET] for switching to the second setting, by setting [UA-21] to 00, you can reduce a great number of displayed items.
- If you are not using option cassettes, by setting [UA-22] to 00, you can reduce indications for option cassettes.

■ (1) Function-specific display: [UA-10]=01

- If a function is not selected, parameters related to the function are hidden.

- For more information about the display condition, see the table below.
- The * mark in the table is replaced by 1 or 2. (1 means 1st-motor, 2 means 2nd-motor.)

(i) IM control parameters

Display condition: AA121≤10 or AA221≤10

Parameter	Name
Hb*02	Async. Motor capacity setting, 1st / 2nd-motor
Hb*03	Async. Motor number of poles setting, 1st / 2nd -motor
Hb*04	Async. Motor base frequency setting, 1st / 2nd –motor
Hb*05	Async. Motor maximum frequency setting, 1st / 2nd -motor
Hb*06	Async. Motor rated voltage, 1st / 2nd -motor
Hb*08	Async. Motor rated current, 1st / 2nd -motor
Hb*10	Async. Motor constant R1, 1st / 2nd-motor
Hb*12	Async. Motor constant R2, 1st / 2nd-motor
Hb*14	Async. Motor constant L, 1st / 2nd-motor
Hb*16	Async. Motor constant I0, 1st / 2nd-motor
Hb*18	Async. Motor constant J, 1st / 2nd-motor
Hb*30	Minimum frequency adjustment, 1st / 2nd-motor
Hb*31	Reduced voltage start time setting, 1st / 2nd-motor
Hb*40	Manual torque boost operation mode selection, 1st / 2nd-motor
Hb*41	Manual torque boost value, 1st / 2nd-motor
Hb*42	Manual torque boost peak speed, 1st / 2nd-motor
Hb*45	Eco drive enable, 1st / 2nd-motor
Hb*46	Eco drive response adjustment, 1st / 2nd-motor
Hb*50	Free-V/f frequency 1 setting, 1st / 2nd-motor
Hb*51	Free-V/f voltage 1 setting, 1st / 2nd-motor
Hb*52	Free-V/f frequency 2 setting, 1st / 2nd-motor
Hb*53	Free-V/f voltage 2 setting, 1st / 2nd-motor
Hb*54	Free-V/f frequency 3 setting, 1st / 2nd-motor
Hb*55	Free-V/f voltage 3 setting, 1st / 2nd-motor
Hb*56	Free-V/f frequency 4 setting, 1st / 2nd-motor
Hb*57	Free-V/f voltage 4 setting, 1st / 2nd-motor
Hb*58	Free-V/f frequency 5 setting, 1st / 2nd-motor
Hb*59	Free-V/f voltage 5 setting, 1st / 2nd-motor
Hb*60	Free-V/f frequency 6 setting, 1st / 2nd-motor
Hb*61	Free-V/f voltage 6 setting, 1st / 2nd-motor
Hb*62	Free-V/f frequency 7 setting, 1st / 2nd-motor
Hb*63	Free-V/f voltage 7 setting, 1st / 2nd-motor
Hb*70	Slip compensation P-gain at V/f with encoder, 1st / 2nd-motor
Hb*71	Slip compensation I-gain at V/f with encoder, 1st / 2nd-motor
Hb*80	Output voltage gain, 1st / 2nd-motor
HC*01	Automatic torque boost voltage compensation gain, 1st / 2nd-motor
HC*02	Automatic torque boost slip compensation gain, 1st / 2nd-motor
HC*10	Zero speed range limit, 1st / 2nd-motor (IM-0Hz-SLV)
HC*11	Boost value at start, 1st / 2nd-motor (IM-SLV,IM-CLV)
HC*12	Boost value at start, 1st / 2nd-motor (IM-0Hz-SLV)
HC*13	Secondary resistance (R2) correction, 1st / 2nd-motor
HC*14	Direction reversal protection, 1st / 2nd-motor
HC*20	Torque current reference filter time constant, 1st / 2nd-motor
HC*21	Speed feedforward compensation gain, 1st / 2nd-motor

(ii) SM (PMM) control parameters

Display condition: AA121>10 or AA221>10

Parameter	Name
Hd*02	Sync. Motor capacity setting, 1st / 2nd-motor
Hd*03	Sync. Motor number of poles setting, 1st / 2nd-motor
Hd*04	Sync. Motor Base frequency setting, 1st / 2nd-motor
Hd*05	Sync. Motor Maximum frequency setting, 1st / 2nd-motor
Hd*06	Sync. Motor rated voltage, 1st / 2nd-motor
Hd*08	Sync. Motor rated current, 1st / 2nd-motor
Hd*10	Sync. Motor constant R, 1st / 2nd-motor
Hd*12	Sync. Motor constant Ld, 1st / 2nd-motor
Hd*14	Sync. Motor constant Lq, 1st / 2nd-motor
Hd*16	Sync. Motor constant Ke, 1st / 2nd-motor
Hd*18	Sync. Motor constant J, 1st / 2nd-motor
Hd*30	Minimum frequency adjustment for Sync.M, 1st / 2nd-motor
Hd*31	No-Load current for Sync.M, 1st / 2nd-motor
Hd*32	Starting method for Sync.M, 1st / 2nd-motor
Hd*33	IMPE 0V wait number for Sync.M, 1st / 2nd-motor
Hd*34	IMPE detect wait number for Sync.M, 1st / 2nd-motor
Hd*35	IMPE detect number for Sync.M, 1st / 2nd-motor
Hd*36	IMPE voltage gain for Sync.M, 1st / 2nd-motor
Hd*37	IMPE Mg-pole position offset, 1st / 2nd-motor
Hd-41	IVMS carrier frequency
Hd-42	Filter gain of IVMS current detection
Hd-43	Open-phase voltage detection gain
Hd-44	Open-phase switching threshold compensation
Hd-45	SM(PMM)-IVMS speed control P gain
Hd-46	SM(PMM)-IVMS speed control I gain
Hd-47	SM(PMM)-IVMS wait time for open-phase switching.
Hd-48	SM(PMM)-IVMS restriction on the rotation-direction determination
Hd-49	SM(PMM)-IVMS open-phase voltage detection timing adjustment.
Hd-50	SM(PMM)-IVMS minimum pulse width adjustment
Hd-51	IVMS threshold current limit
Hd-52	IVMS threshold gain
Hd-58	IVMS carrier-frequency switching start/finish point

(iii) Position control parameters

Display condition: AA123≠00 or AA223≠00

Parameter	Name
AE-01	Electronic gear setting point selection
AE-02	Electronic gear ratio numerator
AE-03	Electronic gear ratio denominator
AE-04	Positioning completed range setting
AE-05	Positioning completed delay time setting
AE-06	Position feedforward gain setting
AE-07	Position loop gain setting

(iv) Orientation

Display condition: AA123=01 or AA223=01

Parameter	Name
AE-08	Position bias setting
AE-10	Stop position selection of home search function
AE-11	Stop position of home search function
AE-12	Speed reference of home search function
AE-13	Direction of home search function

(v) Absolute position control

Display condition: AA123>01 or AA223>01

Parameter	Name
AE-20 to AE-50	Position reference 0 to 15
AE-52	Position control range setting (forward)
AE-54	Position control range setting (reverse)
AE-56	Position control mode selection
AE-60	Teach-in function target selection
AE-61	Save current position at power off
AE-62	Pre-set position data
AE-64	Deceleration stop distance calculation gain
AE-65	Deceleration stop distance calculation bias
AE-66	Speed limit in APR control
AE-67	APR start speed
AE-70	Homing function selection
AE-71	Direction of homing function
AE-72	Low-speed homing speed setting
AE-73	High-speed homing speed setting

(vi) Normal acceleration/deceleration speed

Display condition: AC-02=00

Parameter	Name
AC*15	Accel/Decel change trigger, 1st / 2nd-motor
AC*16	Accel1 to Accel2 frequency transition point, 1st / 2nd-motor
AC*17	Decel1 to Decel2 frequency transition point, 1st / 2nd-motor
AC*20	Acceleration time setting 1, 1st / 2nd-motor
AC*22	Deceleration time setting 1, 1st / 2nd-motor
AC*24	Acceleration time setting 2, 1st / 2nd-motor
AC*26	Deceleration time setting 2, 1st / 2nd-motor

(vii) Multi-stage acceleration/deceleration

Display condition: AC-02=01

Parameter	Name
AC-30	Accel. time for Multi-speed 1
AC-32	Decel. time for Multi-speed 1
AC-34	Accel. time for Multi-speed 2
AC-36	Decel. time for Multi-speed 2
AC-38	Accel. time for Multi-speed 3
AC-40	Decel. time for Multi-speed 3
AC-42	Accel. time for Multi-speed 4
AC-44	Decel. time for Multi-speed 4
AC-46	Accel. time for Multi-speed 5
AC-48	Decel. time for Multi-speed 5
AC-50	Accel. time for Multi-speed 6
AC-52	Decel. time for Multi-speed 6
AC-54	Accel. time for Multi-speed 7
AC-56	Decel. time for Multi-speed 7
AC-58	Accel. time for Multi-speed 8
AC-60	Decel. time for Multi-speed 8
AC-62	Accel. time for Multi-speed 9
AC-64	Decel. time for Multi-speed 9
AC-66	Accel. time for Multi-speed 10
AC-68	Decel. time for Multi-speed 10
AC-70	Accel. time for Multi-speed 11
AC-72	Decel. time for Multi-speed 11
AC-74	Accel. time for Multi-speed 12
AC-76	Decel. time for Multi-speed 12
AC-78	Accel. time for Multi-speed 13
AC-80	Decel. time for Multi-speed 13
AC-82	Accel. time for Multi-speed 14
AC-84	Decel. time for Multi-speed 14
AC-86	Accel. time for Multi-speed 15
AC-88	Decel. time for Multi-speed 15

(viii) Internal current braking

Display condition: AF*01=01, 02

Parameter	Name
AF*02	Braking type selection, 1st / 2nd-motor
AF*03	DC braking frequency, 1st / 2nd-motor
AF*04	DC braking delay time, 1st / 2nd-motor
AF*05	DC braking force setting, 1st / 2nd-motor
AF*06	DC braking active time at stop, 1st / 2nd-motor
AF*07	DC braking operation method selection, 1st / 2nd-motor
AF*08	DC braking force at start, 1st / 2nd-motor
AF*09	DC braking active time at start, 1st / 2nd-motor

(ix) Brake control 1

(same settings for forward / reverse rotation)

Display condition: AF*30=01, 02

Parameter	Name
AF*31	Brake release wait time, 1st / 2nd-motor (Forward)
AF*32	Brake wait time for accel., 1st/2nd-motor (Forward)
AF*33	Brake wait time for stopping, 1st/2nd-motor (Forward)
AF*34	Brake confirmation signal wait time, 1st/2nd-motor (Forward)
AF*35	Brake release frequency setting, 1st/2nd-motor (Forward)
AF*36	Brake release current setting, 1st/2nd-motor (Forward)
AF*37	Braking frequency, 1st/2nd-motor (Forward)

(x) Brake control 1

(individual settings for forward / reverse rotation)

Display condition: AF*30=02

Parameter	Name
AF*38	Brake release wait time, 1st/2nd-motor (Reverse)
AF*39	Brake wait time for accel., 1st/2nd-motor (Reverse)
AF*40	Brake wait time for stopping, 1st/2nd-motor (Reverse)
AF*41	Brake confirmation signal wait time, 1st/2nd-motor (Reverse)
AF*42	Brake release frequency setting, 1st/2nd-motor (Reverse)
AF*43	Brake release current setting, 1st/2nd-motor (Reverse)
AF*44	Braking frequency, 1st / 2nd-motor (Reverse)

(xi) Brake control 2

Display condition: AF*30=03

Parameter	Name
AF*50	Brake open delay time, 1st/2nd-motor
AF*51	Brake close delay time, 1st/2nd-motor
AF*52	Brake response check time, 1st/2nd-motor
AF*53	Servo lock/ DC injection time at start, 1st/2nd-motor
AF*54	Servo lock/ DC injection time at stop, 1st/2nd-motor

(xii) Free electronic thermal

Display condition: bc*11=02

Parameter	Name
bC*20	Free electronic thermal frequency-1, 1st/2nd-motor
bC*21	Free electronic thermal current-1, 1st/2nd-motor
bC*22	Free electronic thermal frequency-2, 1st/2nd-motor
bC*23	Free electronic thermal current-2, 1st/2nd-motor
bC*24	Free electronic thermal frequency-3, 1st/2nd-motor
bC*25	Free electronic thermal current-3, 1st/2nd-motor

(xiii) Gain mapping 1

Display condition: HA*20=00

Parameter	Name
HA*21	ASR gain switching time setting, 1st/2nd-motor
HA*27	ASR gain mapping P control P-gain 1, 1st/2nd-motor
HA*30	ASR gain mapping P control P-gain 2, 1st/2nd-motor

(xiv) Gain mapping 2

Display condition: HA*20=01

Parameter	Name
HA*22	ASR gain mapping intermediate speed 1, 1st / 2nd-motor
HA*23	ASR gain mapping intermediate speed 2, 1st / 2nd-motor
HA*24	ASR gain mapping maximum speed, 1st / 2nd-motor
HA*31	ASR gain mapping P-gain 3, 1st / 2nd-motor
HA*32	ASR gain mapping I-gain 3, 1st / 2nd-motor
HA*33	ASR gain mapping P-gain 4, 1st / 2nd-motor
HA*34	ASR gain mapping I-gain 4, 1st / 2nd-motor

(xv) Instantaneous power failure non-stop

Display condition: bA-30≠00

Parameter	Name
bA-31	Instantaneous power failure non-stop function, start voltage level
bA-32	Instantaneous power failure non-stop function, target voltage level
bA-34	Instantaneous power failure non-stop function, deceleration time
bA-36	Instantaneous power failure non-stop function, start frequency decrement
bA-37	Instantaneous power failure non-stop function, DC bus voltage control P gain
bA-38	Instantaneous power failure non-stop function, DC bus voltage control I gain

(xvi) Overvoltage suppression

Display condition: bA*40≠00

Parameter	Name
bA*41	Overvoltage suppression active level, 1st / 2nd-motor
bA*42	Overvoltage suppression active time, 1st / 2nd-motor
bA*44	Constant DC bus voltage control P gain, 1st / 2nd-motor
bA*45	Constant DC bus voltage control I gain, 1st / 2nd-motor

(xvii) Over-magnetization

Display condition: bA*46≠00

Parameter	Name
bA*47	Over-magnetization function output filter time constant, 1st / 2nd motor
bA*48	Over-magnetization function voltage gain, 1st / 2nd-motor
bA*49	Over-magnetization function level setting, 1st / 2nd-motor

(xviii) PID1

Display condition: AH-01=01, 02

Parameter	Name
db-30	PID1 feedback value 1 monitor
db-32	PID1 feedback value 2 monitor
db-34	PID1 feedback value 3 monitor
db-42	PID1 target value monitor (after calculation)
db-44	PID1 feedback value monitor (after calculation)
db-50	PID1 output monitor
db-51	PID1 deviation monitor
db-52	PID1 deviation 1 monitor
db-53	PID1 deviation 2 monitor
db-54	PID1 deviation 3 monitor
db-61	Current PID P-Gain monitor
db-62	Current PID I-Gain monitor
db-63	Current PID D-Gain monitor
db-64	PID feedforward monitor
FA-30	PID1 set-point 1 setting or monitor
FA-32	PID1 set-point 2 setting or monitor
FA-34	PID1 set-point 3 setting or monitor
AH-02	PID1 deviation inversion
AH-03	Unit selection for PID1
AH-04	PID1 adjustment (0%)
AH-05	PID1 adjustment (100%)
AH-06	PID1 Adjustment (decimal point position)
AH-07	PID1 set-point 1 input source selection
AH-10	PID1 set-point 1 setting
AH-12	PID1 multistage set-point 1
AH-14	PID1 multistage set-point 2
AH-16	PID1 multistage set-point 3
AH-18	PID1 multistage set-point 4
AH-20	PID1 multistage set-point 5
AH-22	PID1 multistage set-point 6
AH-24	PID1 multistage set-point 7
AH-26	PID1 multistage set-point 8
AH-28	PID1 multistage set-point 9
AH-30	PID1 multistage set-point 10
AH-32	PID1 multistage set-point 11
AH-34	PID1 multistage set-point 12
AH-36	PID1 multistage set-point 13
AH-38	PID1 multistage set-point 14
AH-40	PID1 multistage set-point 15
AH-42	PID1 set-point 2 input source selection
AH-44	PID1 set-point 2 setting
AH-46	PID1 set-point 3 input source selection
AH-48	PID1 set-point 3 setting
AH-50	PID1 set-point calculation symbol selection
AH-51	PID1 feedback 1 input source selection
AH-52	PID1 feedback 2 input source selection
AH-53	PID1 feedback 3 input source selection
AH-54	PID1 feedback calculation symbol selection

PID1 (continued)

Display condition: AH-01=01, 02

Parameter	Name
AH-60	PID1 gain change method selection
AH-61	PID1 proportional gain 1
AH-62	PID1 integral time constant 1
AH-63	PID1 derivative gain 1
AH-64	PID1 proportional gain 2
AH-65	PID1 integral time constant 2
AH-66	PID1 derivative gain 2
AH-67	PID1 gain change time
AH-70	PID1 feed-forward input source selection
AH-71	PID1 output range
AH-72	PID1 over deviation level
AH-73	Turn-off level for the PID1 feedback compare signal
AH-74	Turn-on level for the PID1 feedback compare signal

(xix) PID2

Display condition: AJ-01=01, 02

Parameter	Name
db-36	PID2 feedback value monitor
db-55	PID2 output monitor
db-56	PID2 deviation monitor
FA-36	PID2 set-point setting or monitor
AJ-02	PID2 deviation inversion
AJ-03	PID2 unit selection
AJ-04	PID2 scale adjustment (0%)
AJ-05	PID2 scale adjustment (100%)
AJ-06	PID2 scale adjustment (decimal point position)
AJ-07	PID2 set-point input source selection
AJ-10	PID2 set-point setting
AJ-12	PID2 feedback input source selection
AJ-13	PID2 proportional gain
AJ-14	PID2 integral time constant
AJ-15	PID2 derivative gain
AJ-16	PID2 output range
AJ-17	PID2 over deviation level
AJ-18	Turn-off level for the PID2 feedback compare signal
AJ-19	Turn-on level for the PID2 feedback compare signal

(xx) PID3

Display condition: AJ-21=01, 02

Parameter	Name
db-38	PID3 feedback value monitor
db-57	PID3 output monitor
db-58	PID3 deviation monitor
FA-38	PID3 set-point setting or monitor
AJ-22	PID3 deviation inversion
AJ-23	PID3 unit selection
AJ-24	PID3 scale adjustment (0%)
AJ-25	PID3 scale adjustment (100%)
AJ-26	PID3 scale adjustment (decimal point position)
AJ-27	PID3 set-point input source selection
AJ-30	PID3 set-point setting
AJ-32	PID3 feedback input source selection
AJ-33	PID3 proportional gain
AJ-34	PID3 integral time constant
AJ-35	PID3 derivative gain
AJ-36	PID3 output range
AJ-37	PID3 over deviation level
AJ-38	Turn-off level for the PID3 feedback compare signal
AJ-39	Turn-on level for the PID3 feedback compare signal

(xxi) PID4

Display condition: AJ-41=01, 02

Parameter	Name
db-40	PID4 feedback value monitor
db-59	PID4 output monitor
db-60	PID4 deviation monitor
FA-40	PID4 set-point setting or monitor
AJ-42	PID4 deviation inversion
AJ-43	PID4 unit selection
AJ-44	PID4 scale adjustment (0%)
AJ-45	PID4 scale adjustment (100%)
AJ-46	PID4 scale adjustment (decimal point position)
AJ-47	PID4 set-point input source selection
AJ-50	PID4 set-point setting
AJ-52	PID4 feedback input source selection
AJ-53	PID4 proportional gain
AJ-54	PID4 integral time constant
AJ-55	PID4 derivative gain
AJ-56	PID4 output range
AJ-57	PID4 over deviation level
AJ-58	Turn-off level for the PID4 feedback compare signal
AJ-59	Turn-on level for the PID4 feedback compare signal

(xxii) PID in general

Display condition: AH-01=01, 02 or AJ-01=01, 02 or AJ-21=01, 02 or AJ-41=01, 02

Parameter	Name
AH-75	PID soft start function enable
AH-76	PID soft start target level
AH-78	Acceleration time setting for PID soft start function
AH-80	PID soft start time
AH-81	PID soft start error detection enable
AH-82	PID soft start error detection level
AH-85	PID sleep trigger selection
AH-86	PID sleep start level
AH-87	PID sleep active time
AH-88	Enable set-point boost before PID sleep
AH-89	Set-point boost time before PID sleep
AH-90	Set-point boost value before PID sleep
AH-91	Minimum RUN time before PID sleep
AH-92	Minimum active time of PID sleep
AH-93	PID wake trigger selection
AH-94	PID wake start level
AH-95	PID wake start time
AH-96	PID wake start deviation value

(xxiii) Simulation mode

Display condition: PA-20=01

Parameter	Name
PA-21	Error code selection for alarm test
PA-22	Simulation mode: Optional output selection for the output current monitor
PA-23	Optional output value setting for the output current monitor
PA-24	Simulation mode: Optional output selection for the DC bus voltage monitor
PA-25	Optional output value setting for the DC bus voltage monitor
PA-26	Simulation mode: Optional output selection for the output voltage monitor
PA-27	Optional output value setting for the output voltage monitor
PA-28	Simulation mode: Optional output selection for the output torque monitor
PA-29	Optional output value setting for the output torque monitor
PA-30	Simulation mode: Optional frequency matching start enable setting
PA-31	Optional frequency matching start setting value

(xxiv) Trace

Display condition: Ud-01=01

Parameter	Name
Ud-02	Trace start
Ud-03	Number of trace data setting
Ud-04	Number of trace signals setting
Ud-10 to Ud-17	Trace data 0 to 7 selection
Ud-20	Trace signal 0 input/output selection
Ud-21	Trace signal 0 input terminal selection
Ud-22	Trace signal 0 output terminal selection
Ud-23	Trace signal 1 input/output selection
Ud-24	Trace signal 1 input terminal selection
Ud-25	Trace signal 1 output terminal selection
Ud-26	Trace signal 2 input/output selection
Ud-27	Trace signal 2 input terminal selection
Ud-28	Trace signal 2 output terminal selection
Ud-29	Trace signal 3 input/output selection
Ud-30	Trace signal 3 input terminal selection
Ud-31	Trace signal 3 output terminal selection
Ud-32	Trace signal 4 input/output selection
Ud-33	Trace signal 4 input terminal selection
Ud-34	Trace signal 4 output terminal selection
Ud-35	Trace signal 5 input/output selection
Ud-36	Trace signal 5 input terminal selection
Ud-37	Trace signal 5 output terminal selection
Ud-38	Trace signal 6 input/output selection
Ud-39	Trace signal 6 input terminal selection
Ud-40	Trace signal 6 output terminal selection
Ud-41	Trace signal 7 input/output selection
Ud-42	Trace signal 7 input terminal selection
Ud-43	Trace signal 7 output terminal selection
Ud-50	Trace trigger 1 selection
Ud-51	Trigger 1 activation selection at trace data trigger
Ud-52	Trigger 1 level setting at trace data trigger
Ud-53	Trigger 1 activation selection at trace signal trigger
Ud-54	Trace trigger 2 selection
Ud-55	Trigger 2 activation selection at trace data trigger
Ud-56	Trigger 2 level setting at trace data trigger
Ud-57	Trigger 2 activation selection at trace signal trigger
Ud-58	Trigger condition selection
Ud-59	Trigger point setting
Ud-60	Sampling time setting

(xxv) EzSQ

Display condition: UE-02=01,02

Parameter	Name
db-01	Program download monitor
db-02	Program No. monitor
db-03 to db-07	Program counter (Task-1 to Task-5)
db-08 to db-16	User monitor-0 to 4
db-18 to db-23	Analog output monitor YA0 to YA5
UE-01	EzSQ execution cycle
UE-10 to UE-73	EzSQ user parameter U (00) to U(63)
UF-02 to UE-32	EzSQ user parameter UL(00) to UL(15)

■(2) User setting: [UA-10]=02

A

- Parameters set to the user setting functions [UA-31] to [UA-62] are displayed.
Main speed reference setting or monitor [FA-01], Output frequency monitor [dA-01], Display restriction selection [UA-10], and Password for display [UA-01] are always shown.

■(3) Data-comparison display: [UA-10]=03

A

- Only parameters that have been changed from the factory default settings are displayed.
- All monitor displays [d****] and [F****], Display restriction selection [UA-10], and Password for display [UA-01] are always shown.



- The initial value used for comparison is determined by the inverter model and the following settings.
Initialize data selection [Ub-02]
Load type selection [Ub-03]
- When base frequency is changed, the standard value of motor constant I0 is changed, which is regarded as change has been made. (The set value is retained.) When calling the initial value of Hitachi's induction motor (IM), by setting [Hb103] selection of the number of poles to another value (e.g., set 4 poles to 2 poles, and then to 4 poles again), you can set data corresponding with the base frequency after change to [Hb116] Motor constant I0.

■(4) Monitor display: [UA-10]=04

A

- All monitor displays [d****] are displayed.
- Display restriction selection [UA-10], and Password for display [UA-01] are always shown.

9.10.3 Saving Automatically Changed Parameters (User mode)



- I want to create a list of frequently used parameters and make it easier to access them.
- I want to list the changed parameters.



- When [UA-30]"User-parameter auto setting function enable"=00 (initial value), the parameter list set in [UA-31] to [UA-62] is displayed on the user mode screen.
- If you want to get the history of parameter changes, set [UA-30] "User-parameter auto setting function enable" = 01.
Parameters whose data has been changed are automatically stored in [UA-31] to [UA-62] and displayed on the "User mode" screen at the same time. (Up to 32 changed parameters can be stored.)

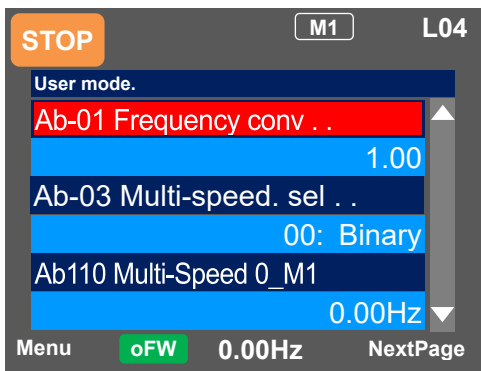

- On the screen that is displayed upon power-on, press the F1(1) key to navigate to the menu screen "M01". Then, select the "02 User mode" by pressing the SEL(O) key.

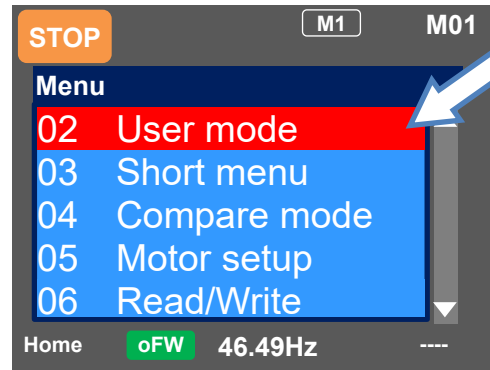

- The following applies when acquiring the history of parameter changes.
 - [UA-31] is the newest change data and [UA-62] is the oldest data.
 - In case of multiple changes of the same parameter that one parameter is memorized.
 - If the number of parameter changes exceeds 32, the oldest [UA-62] data is erased, the data are shifted one step and [UA-31] becomes the latest change data.

Parameter

Name	Code	Data range (unit)	Description
User-parameter auto setting function enable	[UA-30]	00	Disable. The parameters set by the user from [UA-31] to [UA-62] are displayed on the "User mode" screen.
		01	Enabled (change history registration). When a parameter is changed, that parameter is automatically set to [UA-31] to [UA-62].
User-parameter 1 to 32 selection	[UA-31] to [UA-62]	no	No assignment
		*****	- When [UA-30] = 00, the user can set any parameter. - When [UA-30] = 01, the automatically recorded parameters are displayed. (Parameters other than [UA-31] to [UA-62] are subjected)

9.10.4 Protecting Parameters by Password



- I want to protect a parameter value that I changed.
- I do not want anyone to change the setting without permission.



- By setting a password for the Display restriction selection [UA-10] and the Soft-lock selection [UA-16], it is possible to prevent changes to the parameter display items and soft lock settings.



- If you forget the set password, there is no way to unlock the password lock. Also, the password cannot be investigated by our plant or service station, therefore, care must be taken when setting a password.

Parameter

Name	Code	Data range (unit)	Description
Password for display	[UA-01]	0000 to FFFF	Lock/unlock the Display restriction selection [UA-10].
Password for softlock	[UA-02]	0000 to FFFF	Lock/unlock the Soft-Lock selection [UA-16].
Display restriction selection	[UA-10]	00	All parameters are displayed.
		01	Parameters are displayed by functions. Disabled functions are not displayed with some exceptions.
		02	Display is performed in accordance with the settings configured by the user. Parameters set to [UA-31] to [UA-62] are displayed with some exceptions.
		03	Parameters that have been changed from the factory default settings and some other parameters are displayed.
		04	Monitor parameters and some other parameters are displayed.
Soft-lock selection	[UA-16]	00	When the soft lock terminal [SFT] is ON, the parameters depending on the [UA-17] setting cannot be changed.
		01	After setting this parameter to 1, the parameters depending on the [UA-17] setting cannot be changed.
Soft-lock target selection	[UA-17]	00	All data other than [UA-16] and [UA-17] cannot be changed.
		01	Other data cannot be changed except for [UA-16], [UA-17] and frequency references data.
Input terminal function	[CA-01]~ [CA-11]	036	[SFT]: Used when the soft-lock function is used on terminals.

■ Outline of password function
(Example of password for limiting display)

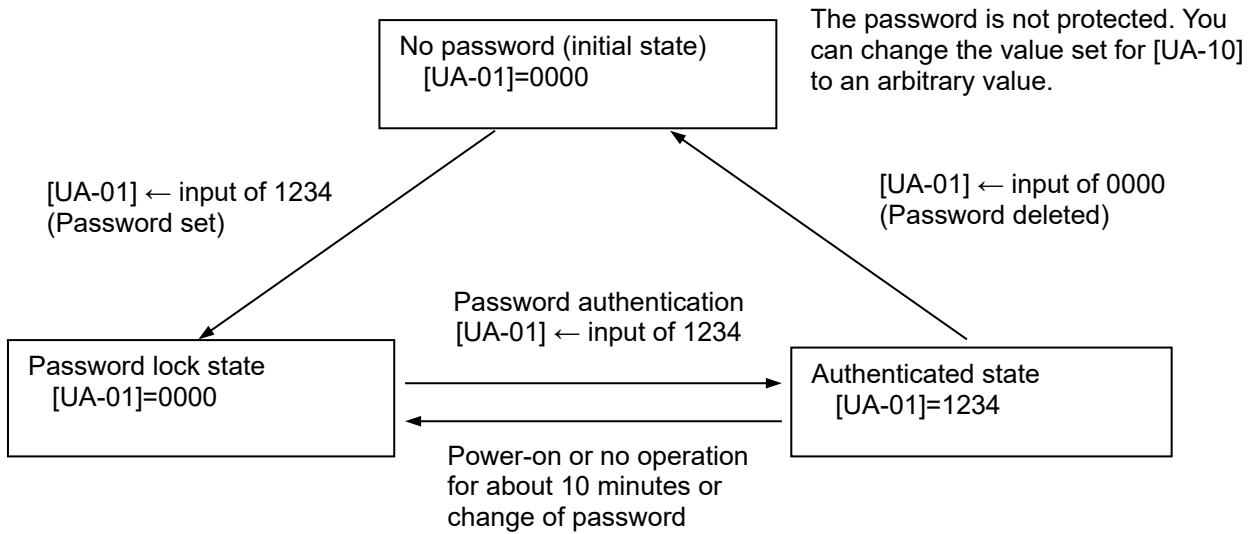

The password is protected. You cannot change the value set for [UA-10]. The LKP icon is displayed in the parameter section.

After password authentication, although the password setting information is not deleted, you can change the value set for [UA-10]. If power is turned on again or 10 minutes pass without any operation, the password is automatically locked again.

■ Outline of password function
(Example of a soft-lock password)

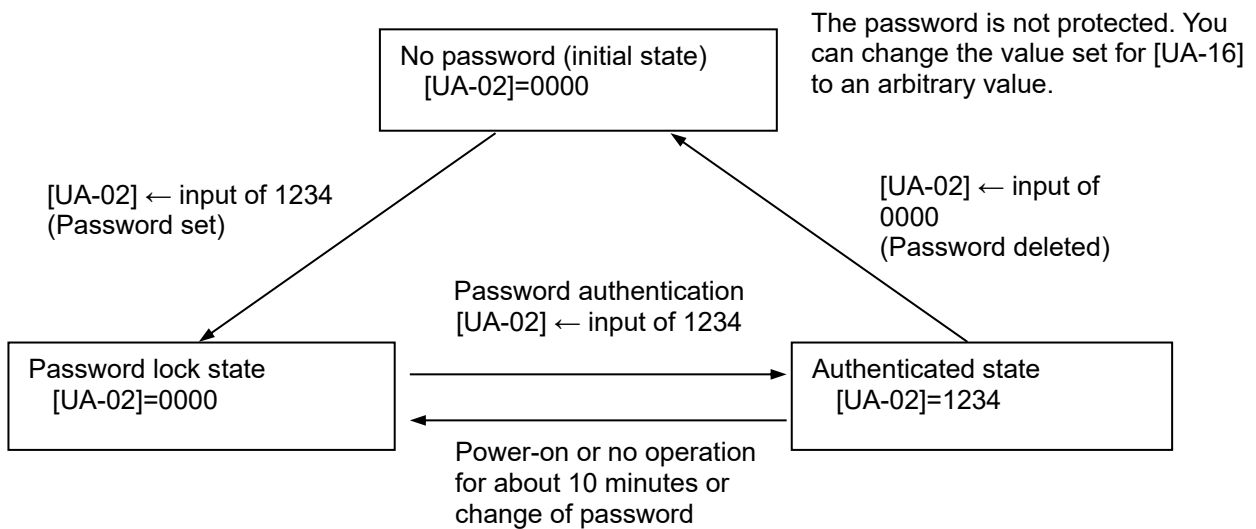

The password is protected. You cannot change the value set for [UA-16]. The LKP icon is displayed in the parameter section.

After password authentication, although the password setting information is not deleted, you can change the value set for [UA-16]. If power is turned on again or 10 minutes pass without any operation, the password is automatically locked again.

9.10.5 Checking the Parameters Changed from the Initial Value (Compare mode)



- I want to check the parameters that have been changed from the default values.



- On the screen that is displayed upon power-on, press the F1(1) key to navigate to the menu screen "M01". Then, select the "04 Compare mode" by pressing the SEL(O) key.

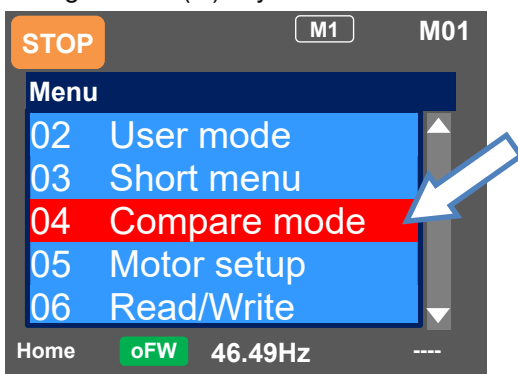

- In compare mode, a list of parameters that are set differently from the initial setting values is displayed.
- If the same value as the initial value is set, it will not be displayed in the compare mode list.
- The figure below shows an example of changing [Ab-01] "Frequency conversion gain" and [Ab110] "Multi-speed 0 setting, 1st-motor" from the initial values.

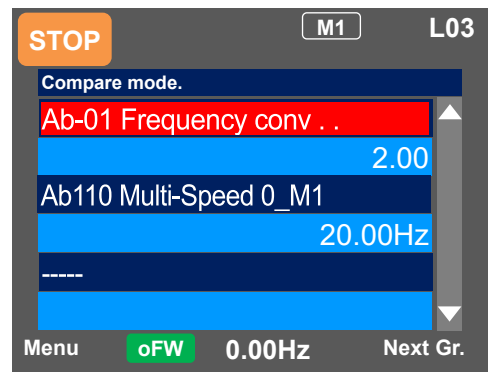

- [F ---] and [d ---] parameters are not applicable. For example, when you change the [FA-01] "Main speed reference setting or monitor" which is an alias for some frequency reference source, the actually linked parameter such as [Ab110] "Multi-speed 0 setting, 1st-motor" is displayed in the compare mode list.
- This function is added from Ver2.02.

9.10.6 Short menu function



- I want to set the minimum necessary parameters for operating the motor.



- On the screen that is displayed upon power-on, press the F1(1) key to navigate to the menu screen "M01". Then, select the "03 Short menu" by pressing the SEL(O) key.



- The "Short menu" is a list of parameters required for general induction motor drive, but it is not always necessary to change the settings.
- In the actual system, parameters other than table below may need to be changed. Set the necessary parameters according to the actual system.



- The short menu summarizes the minimum parameters (table below) required to operate the motor.
- Using the short menu makes it easy to set parameters for operation.

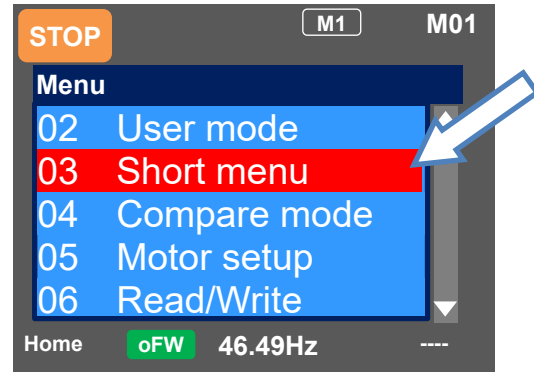

■ "Short menu" parameter list

No	Code	Name	No	Code	Name
1	Ub-03	Load type selection	15	AA115	STOP mode selection, 1st-motor
2	Hb102	Async. Motor capacity setting, 1st-motor	16	Ab110	Multi-speed 0 setting, 1st-motor
3	Hb103	Async. Motor number of poles setting, 1st-motor	17	Ab-11	Multi-speed 1 setting
4	Hb104	Async. Motor base frequency setting, 1st-motor	18	Ab-12	Multi-speed 2 setting
5	Hb105	Async. Motor maximum frequency setting, 1st-motor	19	Ab-13	Multi-speed 3 setting
6	Hb106	Async. Motor rated voltage, 1st-motor	20	bA101	Upper frequency limit source selection, 1st-motor
7	Hb108	Async. Motor rated current, 1st-motor	21	bA102	Upper frequency limit, 1st-motor
8	bC110	Electronic thermal level setting, 1st-motor	22	bA103	Lower frequency limit, 1st-motor
9	AA121	Control mode selection, 1st-motor	23	Cb-40	Thermistor type selection
10	bb101	Carrier frequency setting, 1st-motor	24	CC-07	Output terminal [AL] function
11	AA101	Main speed input source selection, 1st-motor	25	CC-06	Output terminal [16] function
12	AA111	Run command input source selection, 1st-motor	26	bA-61	Dynamic brake activation selection
13	AC120	Acceleration time setting 1, 1st-motor	27	bA-60	Dynamic brake use ratio
14	AC122	Deceleration time setting 1, 1st-motor	28	bA-63	Dynamic brake resistor value

- This function is added from Ver2.02.

9.10.7 Motor setup function



- I want to set and check the parameters related to the basic constants of the motor.
- I want to set the parameters related the motor constants (auto-tuning, stabilization constant settings, etc.).



- On the screen that is displayed upon power-on, press the F1(1) key to navigate to the menu screen "M01". Then, select the "05 Motor setup" by pressing the SEL(O) key.



- "Motor setup" is a list of minimum parameters related to motor constants and parameters related to motor characteristics and drive characteristics such as auto-tuning, stabilization constant, and speed response.
- In the actual system, parameters other than table below may need to be changed. Set the necessary parameters according to the actual system.



- The "Motor Setup" menu summarizes the basic parameters of the motor and the basic parameters related to stability such as auto-tuning / stabilization constant and speed response (table below).
- The "Motor Setup" menu makes it easy to set the minimum necessary motor constant related parameters.

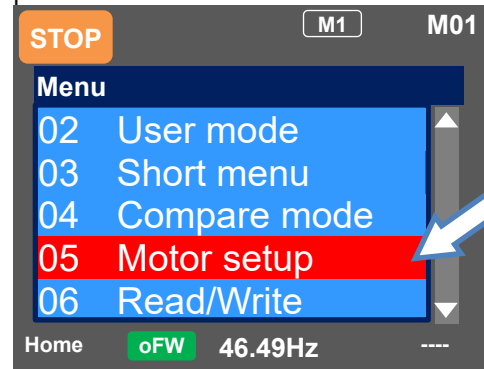

■ "Motor setup" parameter list

No	Code	Name	No	Code	Name
1	dC-45	IM/SM monitor	20	Hd103	Sync. Motor number of poles setting, 1st-motor
2	HA-01	Auto-tuning selection	21	Hd104	Sync. Motor Base frequency setting, 1st-motor
3	HA-02	Auto-tuning RUN command source selection	22	Hd105	Sync. Motor maximum frequency setting, 1st-motor
4	HA-03	Online auto-tuning selection	23	Hd106	Sync. Motor rated voltage, 1st-motor
5	Hb102	Async. Motor capacity setting, 1st-motor	24	Hd108	Sync. Motor rated current, 1st-motor
6	Hb103	Async. Motor number of poles setting, 1st-motor	25	Hd110	Sync. Motor constant R, 1st-motor
7	Hb104	Async. Motor base frequency setting, 1st-motor	26	Hd112	Sync. Motor constant Ld, 1st-motor
8	Hb105	Async. Motor maximum frequency setting, 1st-motor	27	Hd114	Sync. Motor constant Lq, 1st-motor
9	Hb106	Async. Motor rated voltage, 1st-motor	28	Hd116	Sync. Motor constant Ke, 1st-motor
10	Hb108	Async. Motor rated current, 1st-motor	29	Hd118	Sync. Motor constant J, 1st-motor
11	Hb110	Async. Motor constant R1, 1st-motor	30	Hd130	Minimum frequency adjustment for Sync.M, 1st-motor
12	Hb112	Async. Motor constant R2, 1st-motor	31	Hd131	No-Load current for Sync. M., 1st-motor
13	Hb114	Async. Motor constant L, 1st-motor	32	Hd132	Starting method for Sync. M., 1st-motor
14	Hb116	Async. Motor constant I0, 1st-motor	33	Hd133	IMPE 0V wait number for Sync. M., 1st-motor
15	Hb118	Async. Motor constant J, 1st-motor	34	Hd134	IMPE detect wait number for Sync. M., 1st-motor
16	HA110	Stabilization constant, 1st-motor	35	Hd135	IMPE detect number for Sync. M., 1st-motor
17	HA115	Speed response, 1st-motor	36	Hd136	IMPE voltage gain for Sync.M, 1st-motor
18	Hb180	Ouput voltage gain, 1st-motor	37	Hd137	IMPE Mg-pole position offset, 1st-motor
19	Hd102	Sync. Motor capacity setting, 1st motor			

- This function is added from Ver2.02.

9.11 Display Fixation Function

9.11.1 Fixation of Display Using the DISP Terminal

Q

- I don't want anyone to operate the inverter on the operator keypad without permission.

A

- When the input terminal [DISP] function is on, display of the operator keypad VOP is fixed on the monitor screen (the home screen selected in VOP).
- When the input terminal [DISP] function is on, the keys other than the RUN key and the STOP/RESET key are disabled.
- To disable the RUN key, set [AA111] to a value other than 02.
- The following shows operations when the [DISP] terminal is on.
 - When STOP-key enable [AA-13] is 01, even if [AA111] is other than 02, you can stop the inverter or reset inverter trip by using the STOP/RESET key.
 - When STOP-key enable [AA-13] is 02, even if [AA111] is other than 02, you can reset inverter trip by using the STOP/RESET key.
 - When STOP-key enable [AA-13] is 00, if [AA111] is other than 02, the STOP/RESET key is also disabled, thus disabling all keys.

Parameter

Name	Code	Data range (unit)	Description
Input terminal function	[CA-01]~ [CA-11]	102	[DISP]: Used when the screen fixation function is used on terminals.
RUN command input source selection, 1st-motor	[AA111]	00	[FW]/[RV] terminals
		01	3 wire
		02	Keypad's RUN-key
		03	RS485
		04	Option 1
		05	Option 2
STOP-key enable	[AA-13]	00	Disable
		01	Enable
		02	Enable at only trip reset

9.12 Error Operation on the Operator Keypad

9.12.1 Selection of Operation at Disconnection of Operator Keypad

Q

- I want to trip the inverter when connection with the operator keypad is shut off.
- I want to decelerate and stop the inverter when connection with the operator keypad is shut off.

A

- You can configure operation when the operator keypad is disconnected. When about 5 seconds have passed after communication with the operator keypad is disconnected, it is determined that disconnection occurred.
- For operation at disconnection, see the parameter table shown below.

Parameter

Name	Code	Data range (unit)	Description
Action selection at keypad disconnection	[UA-20]	00	When disconnection occurs, the inverter trips due to [E040] Operator keypad communication error.
		01	When disconnection occurs, the inverter trips with [E040] Operator keypad communication error after deceleration stop.
		02	Ignores detection of disconnection.
		03	Performs the free-run stop when disconnection occurs. No error occurs.
		04	Performs the deceleration stop when disconnection occurs. No error occurs.

9.12.2 Display of Battery Level Warning

Q

- I want to know if I should replace the battery of the operator keypad VOP when it runs out.
- I want to trip the inverter due to error when the battery of the operator keypad runs out.

A

- The operator keypad VOP is monitored on a regular basis, and when it is determined the date and time setting of operator keypad VOP returns to the initial state, it is determined to be error.
- When [UA-19] is set to 01 and it is determined that abnormality occurs, the output terminal function 080[LBK] is turned on. When date and time is configured on VOP, [LBK] is turned off.
- When [UA-19] is set to 02, when it is determined that abnormality occurs, an error is generated, and the inverter trips due to [E042] RTC error. The output terminal function 080 [LBK] is turned on at the same time the error occurs. When time on VOP is configured, [LBK] is turned off.

!

- You can cancel trip of [E042] RTC error by performing the reset operation, however, if date and time is not configured, the error occurs again. In this case, the output terminal function 080 [LBK] is on.
- If [UA-19] is set to a value other than 00, insert the battery in the operator keypad VOP, and set [UA-19] after configuring date and time.

Parameter

Name	Code	Data range (unit)	Description
Low battery warning enable	[UA-19]	00	Disable
		01	The output terminal function 080 [LBK] is turned on as a warning.
		02	The Inverter trip [E042] RTC error occurs. Turns on the output terminal function 080 [LBK].

9.13 Prevention of Unnecessary Read/Write

9.13.1 Disabling Data Read/Write



- I want to disable the Read/Write function of the operation panel VOP.



- If the Data R/W selection [UA-18] set to 01, the Read/Write function of keypad VOP (see “9.6 Copy Data!”) is disabled.
- After the parameter setting is fixed and the data are read to the VOP with the Read/Write function as a backup and then [UA-18] is set to 01 (R/W disabled), Unintended parameters Read/Write is prevented.

Parameter

Name	Code	Data range (unit)	Description
Data R/W selection	[UA-18]	00	R/W enabled. Read/Write function of VOP is possible.
		01	R/W disabled. Read/Write function of VOP is impossible.

10

Chapter 10 Test Run

Contents





10.1 What This Chapter Explains	10-1
10.2 Let's Check the Procedures Before Test Runs ! ...	10-2
10.3 Settings and Commands	
Required for Running the Inverter	10-3
10.4 Let's Configure Settings for Test Runs!	10-4
10.4.1 How to Perform Test Runs	
Using the Operator Keypad VOP	10-4
10.4.2 Operates the Inverter with [FW] Terminal	
and [Ai1] Analog Frequency	10-6
10.4.3 Supplement for Test Runs	10-7
10.5 Checking in the Simulation Mode	10-8

10.1 What This Chapter Explains

This chapter provides an operational flow to do a test run.

For method for using the operator keypad VOP, see "10.4.1 How to Perform Test Runs Using the Operator Keypad VOP" and "Chapter 9 Operating". Furthermore, to do a test run not via the operator keypad VOP, configure the setting by referring to "Chapter 11 Frequency References and RUN Commands Examples".

Before conducting a test run, make sure to carefully read "Chapter 1 Safety Instructions/Risks" for safety work.

Symbol	Meanings
	General and troubleshooting questions
	Key points for a solution
	Notes
	Confirmation of procedures

10.2 Let's Check the Procedures Before Test Runs !



- I want to check the procedure for test runs.
- I want to check the operation performance between this unit and the host device even though a load and motor have not been connected yet.
- I want to confirm how the system behaves in an error condition, via making error conditions.



- To perform a test run, follow the procedures shown below.
- Carefully read and understand “Chapter 1 Safety Instructions/Risks” and the relevant instructions in the following chart before starting works.

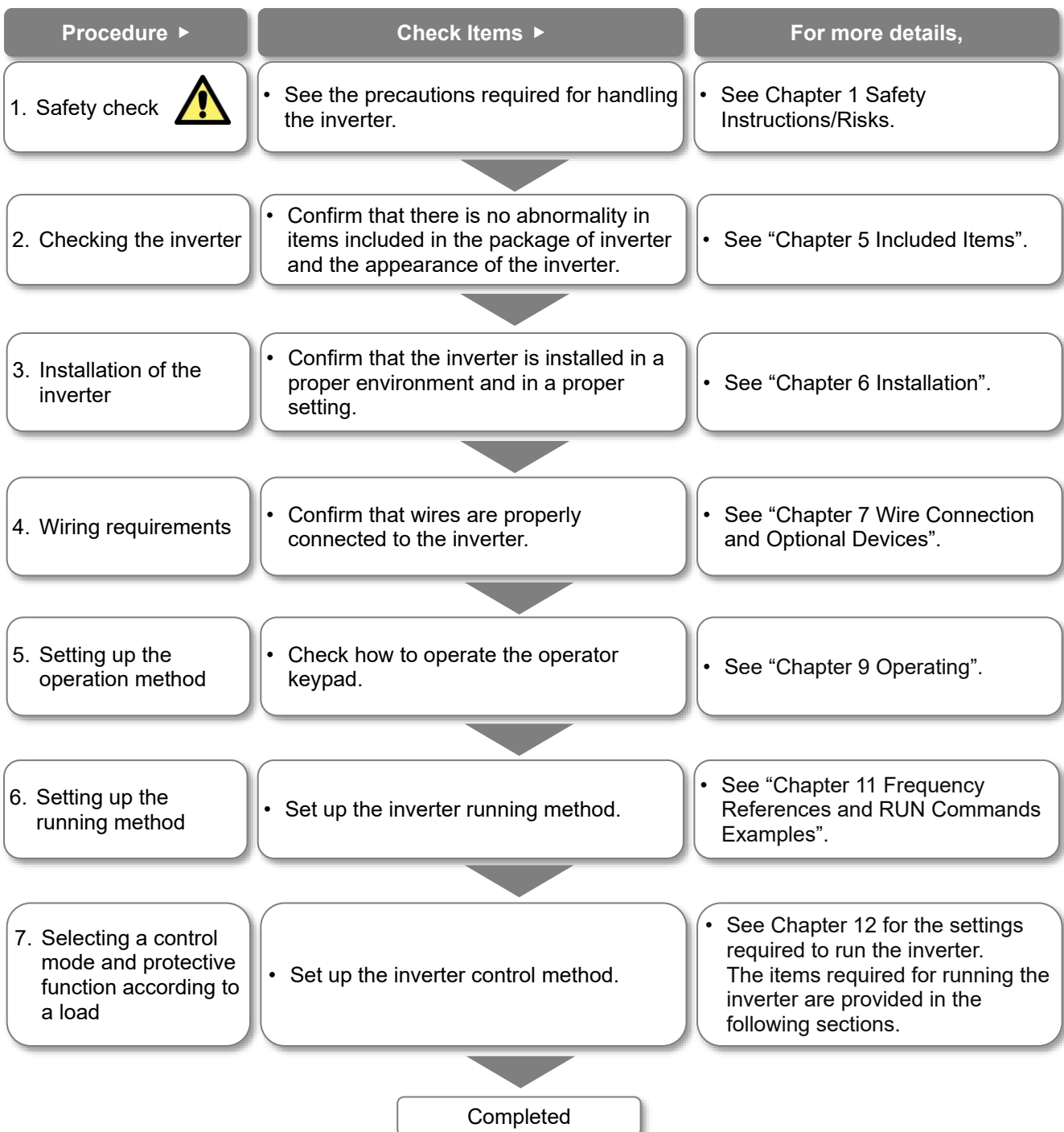

10.3 Settings and Commands

Required for Running the Inverter



- I want to turn the motor.



- To turn the motor, configure the following settings:

1

Basic setting of motor

- Set the following parameters in accordance with the plate of motor. Set the data indicating the basic characteristics of motor.

Item	Parameter	
	IM	SM(PMM)
Motor capacity setting, 1st-motor	[Hb102]	[Hd102]
Motor number of poles setting, 1st-motor	[Hb103]	[Hd103]
Motor base frequency setting, 1st-motor	[Hb104]	[Hd104]
Motor maximum frequency setting, 1st-motor	[Hb105]	[Hd105]
Motor rated voltage, 1st-motor	[Hb106]	[Hd106]
Motor rated current, 1st-motor	[Hb108]	[Hd108]

*) See "12.3 Basic Setting of Motor" for details.

2

Setting for protection of motor

- The motor may be burned if a large current keeps on flowing in the motor; the setting therefore must be performed appropriately.

Item	Parameter
Electronic thermal level setting, 1st-motor	[bC110]
Electronic thermal characteristic selection, 1st-motor	[bC111]

*) See "12.7 Temperature Protection of Motor" for details.

3

Setting for activating the motor

- The voltage output of the inverter requires not only a RUN command but also a frequency reference. In the initial state, a main speed reference is set.

Item	Parameter
Main speed input source selection, 1st-motor	[AA101]
RUN command input source selection, 1st-motor	[AA111]
Main speed reference setting or monitor	[FA-01]

*) For details, see "12.4 Selection of Frequency Reference", "12.5 Selection of RUN Command" and "Chapter 11 Frequency References and RUN Commands Examples".



- This article explains the settings for operation. Carefully read Safety Instructions before handling the inverter.

4

Settings for motor control

- Set the motor control method.
- For changing to the mode of driving an SM (PMM), you need to change the control method.

Item	Parameter
Control mode selection, 1st-motor	[AA121]

*) For details, see "12.9 Select the Appropriate Control Mode for the Motor and Load".

- When driving an SM (PMM) or using other motors than Hitachi's standard motors, or setting long wiring length, you need to set up the following motor constants:

- For induction motor IM

Item	Parameter
Async. Motor constant R1, 1st-motor	[Hb110]
Async. Motor constant R2, 1st-motor	[Hb112]
Async. Motor constant L, 1st-motor	[Hb114]
Async. Motor constant I0, 1st-motor	[Hb116]
Async. Motor constant J, 1st-motor	[Hb118]

- For synchronous motor (permanent magnetic motor) (SM (PMM))

Item	Parameter
Sync. Motor constant R, 1st-motor	[Hd110]
Sync. Motor constant Ld, 1st-motor	[Hd112]
Sync. Motor constant Lq, 1st-motor	[Hd114]
Sync. Motor constant Ke, 1st-motor	[Hd116]
Sync. Motor constant J, 1st-motor	[Hd118]

10.4 Let's Configure Settings for Test Runs!

10.4.1 How to Perform Test Runs Using the Operator Keypad VOP



- Want to perform a test run using operator keypad VOP.



- From the initial screen displayed at power-on, move to "H03" with the LEFT/RIGHT (◀▶) keys.
- For procedure of changing parameters, see "9.3 Let's Set Up the Parameters!".

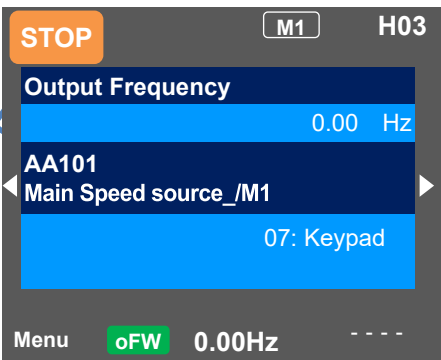
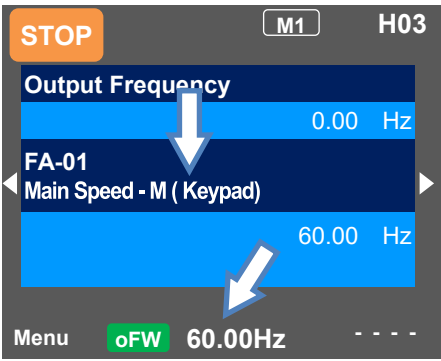

- To perform a test run only via operator keypad VOP, set the following parameters from the initial value, or check the following parameters.
 - ① [AA101] Main speed input source selection, 1st-motor
 - ② [FA-01] Main speed reference setting or monitor
 - ③ [AA111] RUN command input source selection, 1st-motor
 - ④ [bC110] Electronic thermal level setting, 1st-motor

Display description	Setting item
① 	① Setting of the [AA101] Main speed input source selection, 1st-motor. Set the frequency reference source to "07: keypad".
② 	② Checking of the [FA-01] Main speed reference setting or monitor. When the "Main speed input source selection" is set to "07: Keypad", "Main Speed-M(Keypad)" will be shown. When the setting of the screen bottom center is the frequency reference (initial setting), the ① setting is displayed there.

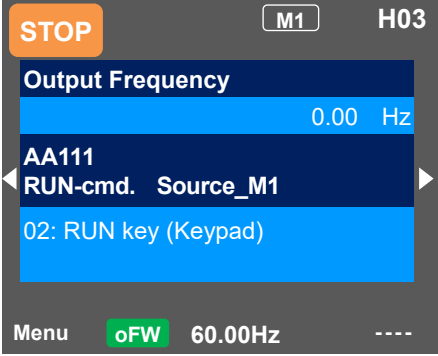
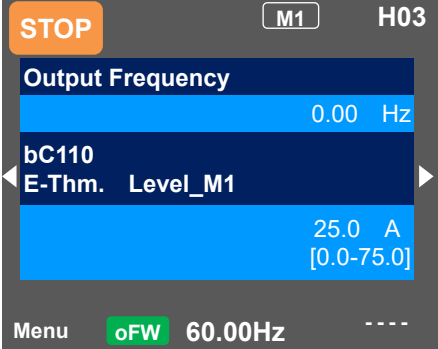
Setting item	Note
<p>③</p> 	<p>③ Setting of the [AA111] RUN command input source selection. When the RUN command input source selection is set to "02: RUN key (Keypad)", "oFW" will be shown on operator keypad at the bottom in the area for displaying function of RUN key.</p> <p>※ When the direction is set to reverse rotation, "oRV" will be shown.</p>
<p>④</p> 	<p>④ Setting of the [bC110] Electronic thermal level setting. Set the level so that it does not exceed the rated current of motor.</p> <p>⚠ Note that the motor may be burned if the electronic thermal level is not appropriately set.</p> <p>※ The electronic thermal function for protecting the inverter operates separately. There are not user setting parameters for this function. For details, refer to "12.7.1 Electronic Thermal Settings of Motor".</p>

10.4.2 Operates the Inverter with [FW] Terminal and [Ai1] Analog Frequency



- I want to perform a Test Run, using a volume of variable resistor.
- I want to run with 10 VDC voltage analog input.



- From the initial screen displayed at power-on, move to "H03" with the LEFT/RIGHT arrow (◀▶) keys.
- For procedure of changing parameters, see "9.3 Let's Set Up the Parameters!".

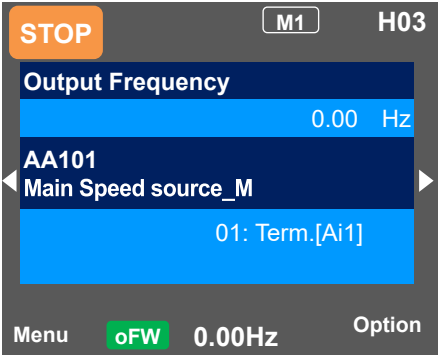
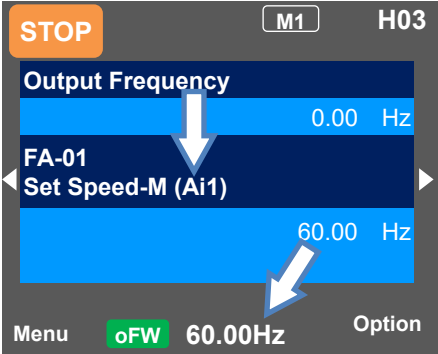

- To perform a test run using analogue input Ai1, set the following parameters from the initial value, or check the following parameters.
 - ① [AA101] Main speed input source selection, 1st-motor
 - ② [FA-01] Main speed reference setting or monitor
 - ③ [AA111] RUN command input source selection, 1st-motor
 - ④ [bC110] Electronic thermal level setting, 1st-motor

Display description	Setting item
<p>①</p>  <p>The screenshot shows the 'H03' menu with 'AA101 Main Speed source_M' selected. The value is '01: Term.[Ai1]'. A blue arrow points to the parameter name. The bottom status bar shows 'Menu oFW 0.00Hz Option'.</p>	<p>① Setting of the [AA101] Main speed input source selection, 1st-motor. Set the frequency reference source to "01:Term.[Ai1]."</p>
<p>②</p>  <p>The screenshot shows the 'H03' menu with 'FA-01 Set Speed-M (Ai1)' selected. The value is '60.00 Hz'. A blue arrow points to the parameter name, and another points to the frequency value. The bottom status bar shows 'Menu oFW 60.00Hz Option'.</p>	<p>② Checking of the [FA-01] Main speed reference setting or monitor. When the frequency reference source is set to "01:Term.[Ai1]", "Set speed-M (Ai1)" will be shown. If a frequency reference is set in this state, the value will be shown at the bottom command monitor area.</p>



- To connect a cable between Ai1 and L, or between Ai2 and L, make sure to check that a desired input (voltage or current) is provided to the corresponding positions of DIP switch SW1 and SW2.



Failure



Prohibited

- A damage may be caused by inputting a wrong voltage or current for reasons such as wrong selection of switches, input beyond the specification range (P24 terminal of 24 VDC is used instead of H terminal of 10 VDC), and wrong wiring (voltage/current being input reversely because the wire is connected in the wrong way; H and L are short-circuited during analog input using the H terminal; and so on).

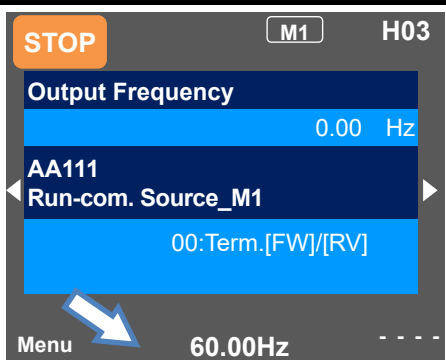
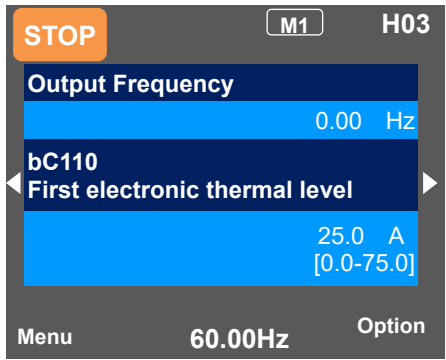
Setting item	Note
<p>③</p> 	<p>③ Setting of the [AA111] RUN command input source selection, 1st-motor When the RUN command source is set to "00:Term.[FW]/[RV]", the display "oFW" disappears from the bottom of screen on the operator keypad.</p> <p>※ Forward / Reverse rotation can be set at [FW]/[RV] terminal.</p>
<p>④</p> 	<p>④ Setting of the [bC110] Electronic thermal level setting, 1st-motor. Set the level so that it does not exceed the rated current of motor.</p> <p>⚠ Note that the motor may be burned if the electronic thermal level is not appropriately set.</p> <p>※ The electronic thermal function for protecting the inverter operates separately. There are not user setting parameters for this function. For details, refer to "12.7.1 Electronic Thermal Settings of Motor".</p>

10.4.3 Supplement for Test Runs



- Check the setting of the motor capacity, the number of motor poles, frequency, voltage, and current in order to conduct motor control.
- IM: Induction motor

General motor items	Code	Setting range (unit)
Capacity	[Hb102]	0.01 to 160.00 (kW) (P1-550L/P1-1320H or under) 0.01 to 500.00 (kW) (P1-1600H or over)
Number of motor poles	[Hb103]	0 to 23 (02 to 48 poles)
Frequency	[Hb104]	10.00 to 590.00 (Hz)
	[Hb105]	10.00 to 590.00 (Hz)
Voltage	[Hb106]	1 to 1000 (V)
Current	[Hb108]	0.01 to 10000.00 (A)

- SM (PMM): Synchronous (permanent magnet) motor

General motor items	Code	Setting range (unit)
Capacity	[Hd102]	0.01 to 160.00 (kW) (P1-550L/P1-1320H or under) 0.01 to 500.00 (kW) (P1-1600H or over)
Number of motor poles	[Hd103]	0 to 23 (02 to 48 poles)
Frequency	[Hd104]	10.00 to 590.00 (Hz)
	[Hd105]	10.00 to 590.00 (Hz)
Voltage	[Hd106]	1 to 1000 (V)
Current	[Hd108]	0.01 to 10000.00 (A)

- See "12.3 Basic Setting of Motor" for details.
- In the initial state, the motor is in the V/f control mode, in which voltage is output proportional to the frequency for induction motor control.
For control modes, see "12.9 Select the Appropriate Control Mode for the Motor and Load".

10.5 Checking in the Simulation Mode



- I want to check terminal functions without the inverter output to the motor.
- I want to check simulative operation of the inverter by giving a RUN command without output to the motor.



- If the [PA-20] Simulation mode enable is set to 01 and the power supply is turned on again, the inverter enters the simulation mode and does not output to the motor.
- To cancel the simulation mode, set [PA-20] to 00 and then turn on the power again.
- Because the inverter behaves just like a normal operation except that it cannot output to the motor, you can check terminals and communication operations.
- It will be possible to change the internal data on a real-time basis by assigning a parameter or analog input to the internal data.
- Simulation mode can be operated with R0T0 control power supply input or 24 VDC power supply input.
- If the error code is set to the Error code selection for alarm test [PA-21] during the simulation mode, the trip is occurred as soon as the setting is made. To cancel a trip, reset the inverter (turn ON the [RS] terminal or press RESET key) as usual. When the inverter is reset, [PA-21] automatically returns to "000".



Entering the simulation mode

- 1 Set the [PA20] Simulation mode enable to 01.
- 2 Turn off the power supply, and turn it on again.
- 3 The simulation mode becomes active.



- The motor cannot be driven in the simulation mode.
- To check the actual motor behavior, set the [PA-20] to "00: Disable" and then turn on the power supply again.
- Because the simulation mode is for simulating terminals' behaviors, the function activated by a motor control operation does not work.
- In the simulation mode, if an error not implemented is entered to [PA-21], the error will not be occurred.
- In the simulation mode, if a major failure is entered to [PA-21], the power supply needs to be turned on again. (Major failure: E008, E010, E011, E014, E019, E020)



Canceling the simulation mode

- 1 Set the [PA-20] Simulation mode enable to 00.
- 2 Turn off the power supply, and turn it on again.
- 3 The simulation mode is canceled.

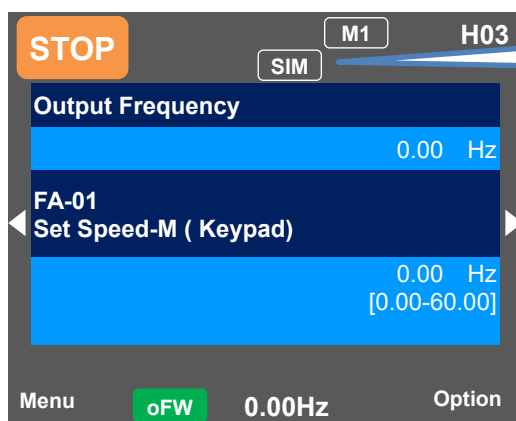

Indicated during the simulation mode.

(Example: usage 1)

Checking the behavior while the alarm [AL] is on.

- The operation was started.
- [PA-24] “Simulation mode: Optional output selection for the DC bus voltage monitor” was set to 01, and [PA-25] “Optional output value setting for the DC bus voltage monitor” was set to the maximum value.

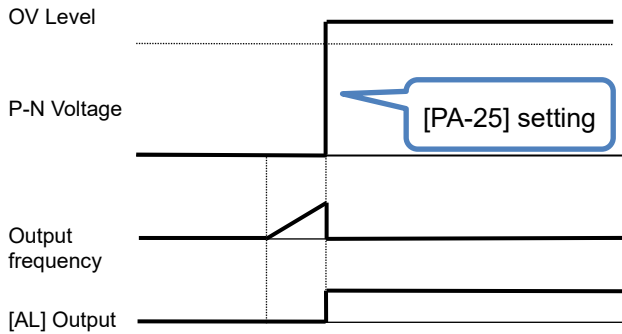

- An overvoltage error [E007] occurred and [AL] was ON.

(Example: usage 2)

Checking the signal output of overload prewarning level [OL].

- The [CE106] “Overload warning level 1, 1st motor” was set, and the operation was started.
- [PA-22] “Simulation mode: Optional output selection for the output current monitor” was set to 02, and [Ai1] was increased and decreased.

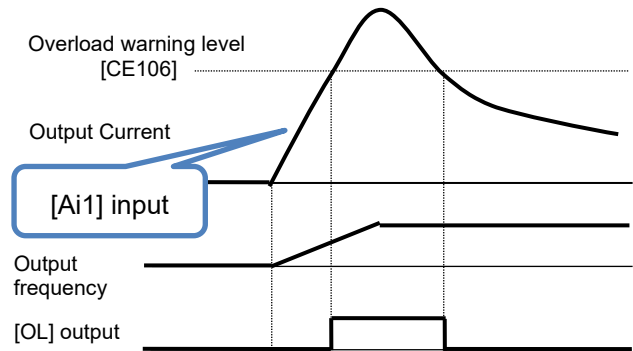

- [OL] was turned ON because the output current exceeded the [CE106] Overload warning level.

Parameter

Item	Parameter	Data	Description
Simulation mode enable	[PA-20]	00	Disable
		01	Enable
Error code selection for alarm test	[PA-21]	000 to 255	Issues a set error. Errors number not implemented are not occurred.
Simulation mode: Optional output selection for the output current monitor. Optional output selection for the DC bus voltage monitor Optional output selection for the output voltage monitor Optional output selection for the output torque monitor Optional frequency matching start enable setting	[PA-22] [PA-24] [PA-26] [PA-28] [PA-30]	00	Disable
		01	Parameter setting
		02	Setting by Terminal [Ai1]
		03	Setting by Terminal [Ai2]
		04	Setting by Terminal [Ai3]
		05	Setting by Terminal [Ai4]
		06	Setting by Terminal [Ai5]
		07	Setting by Terminal [Ai6]
Optional output value setting for the output current monitor	[PA-23]	0.0 to 3.0 × Inverter rated current (A)	Treats the set values as internal output values.
Optional output value setting for the DC bus voltage monitor	[PA-25]	200V class: 0.0 to 450.0 (VDC) 400V class: 0.0 to 900.0 (VDC)	Treats the set values as internal output values.
Optional output value setting for the output voltage monitor	[PA-27]	200V class: 0.0 to 300.0(V) 400V class: 0.0 to 600.0(V)	Treats the set values as internal output values.
Optional output value setting for the output torque monitor.	[PA-29]	-500.0 to 500.0 (%)	Treats the set values as internal output values.
Optional frequency matching start setting value.	[PA-31]	0.00 to 590.00 (Hz)	Treats the set values as internal output values.





(Memo)

11

Chapter 11 Frequency References and RUN Commands Examples

Contents

11.1 What This Chapter Explains	11-1
11.2 How to Input Each Frequency References and RUN Commands	11-1
11.2.1 Frequency on the Keypad	11-2
11.2.2 RUN on the Keypad	11-2
11.2.3 Frequency with the multi-speed	11-3
11.2.4 RUN with the FW/RV input terminal	11-3
11.2.5 Frequency with External Analog Input....	11-4
11.2.6 RUN with the 3-Wire Method	11-4
11.2.7 Adjusting Analog Inputs (Ai1/Ai2)	11-5
11.2.8 Adjusting Analog Outputs (Ao1/Ao2/FM)	11-5
11.2.9 Adjusting Analog Input (Ai3)	11-6
11.2.10 Prevention of Malfunction of Input Terminals	11-6
11.2.11 Stabilization of Output Terminals	11-6

Symbol	Meanings
	General and troubleshooting questions
	Key points for a solution
	Notes
	Confirmation of procedures

11.1 What This Chapter Explains

This chapter provides examples of settings by connection at a frequency reference source and RUN command source. In respective settings, an RUN command and frequency reference are to be set separately; hence it is possible to set according to working environments by combining each command. Make sure to carefully read “Chapter 1 Safety Instructions/Risks” for safety work.

11.2 How to Input Each Frequency References and RUN Commands



- In this chapter, frequency references and RUN commands are explained separately. Both frequency references and RUN commands can be combined with other examples.



- The inverter does not output until both a frequency reference (e.g. 60Hz) and a RUN command (e.g. input terminal [FW]) are entered.

■ Frequency reference 1

11.2.1 Frequency on the Keypad

- On the parameter setting screen, select [AA101] = 07 frequency reference.
- Frequency reference can be changed either [FA-01] or [Ab110] (When there is no factor for changing the frequency reference source such as multi-speed terminal or etc.).

(Example) For [FA-01]

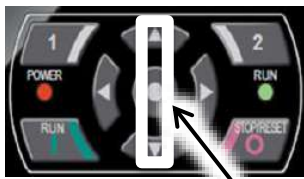
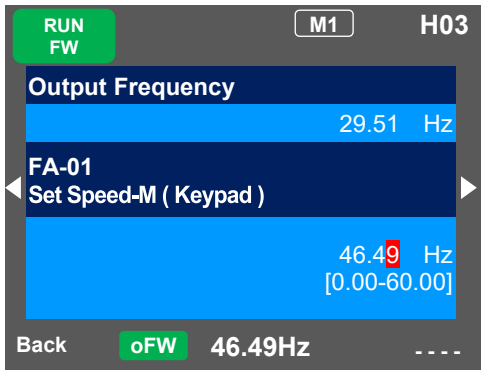

■ Frequency reference

- Frequency reference can be changed by using UP/DOWN keys to set the "Main speed reference setting or monitor" [FA-01] to a desired setting.

■ Parameter

Parameter	Setting function	Set value
[AA101]	Parameter Setting	07
[FA-01] *)	Main speed reference setting or monitor	0.00Hz
[Ab110] *)	Multi-speed 0 setting	0.00Hz

*) If [AA101] is set to 07, a change made to either [FA-01] or [Ab110] parameter will be reflected to the both parameter. [FA-01] changes the set value of the currently selected frequency reference ([FA-01] is an alias for the frequency setting parameters). If [FA-01] cannot be changed or the change is not reflected, the command source is not the operator keypad due to the terminal function (analog input) or the [AA101] setting. The frequency reference value must be set to a value other than 0.00.

■ RUN command 1

11.2.2 RUN on the Keypad

- On the parameter setting screen, select 02 for [AA111].



RUN key (to run)

STOP key (to stop)



■ RUN and STOP command

You can run and stop the inverter by pressing RUN key and STOP key on the operator keypad.

■ Parameter

Parameter	Setting function	Set value
[AA111]	Keypad's RUN-key	02

■ Frequency reference 2

11.2.3 Frequency with the multi-speed

- If the multi-speed functions of the input terminal function are not turned ON, the frequency reference source depends on the [AA101] setting.
- When Multi-speed 0 is used, set 07 to the [AA101].

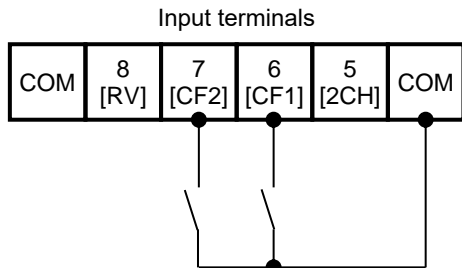

■ Frequency reference

- Switch the frequency references by ON/OFF inputs of the multi-speed terminals [CF1] and [CF2].

■ Parameter

Parameter	Setting function	Set value
[AA101]	Parameter Setting	07
[FA-01] *1)	Main speed reference setting or monitor	0.00Hz
[Ab110] *1)	Multi-speed 0 setting ([CF1] OFF / [CF2] OFF)	0.00Hz
[Ab-11] *2)	Multi-speed 1 setting ([CF1] ON / [CF2] OFF)	0.00Hz
[Ab-12] *2)	Multi-speed 2 setting ([CF1] OFF / [CF2] ON)	0.00Hz
[Ab-13] *2)	Multi-speed 3 setting ([CF1] ON / [CF2] ON)	0.00Hz
[CA-06]	Input terminal [6] function. (for [CF1]).	001
[CA-07]	Input terminal [7] function (for [CF2]).	002

*1) If [AA101] is set to 07, a change made to either [FA-01] or [Ab110] parameter will be reflected to the both parameter. [FA-01] changes the set value of the currently selected frequency reference ([FA-01] is an alias for the frequency setting parameters). If [FA-01] cannot be changed or the change is not reflected, the frequency reference source is not the operator keypad due to the terminal function (analog input) or [AA101].

*2) Set the frequency references used at the multi-stage speed reference.

■ RUN command 2

11.2.4 RUN with the FW/RV input terminal

- Select 00 [FW]/[RV] terminal for [AA111] on the parameter setting screen.

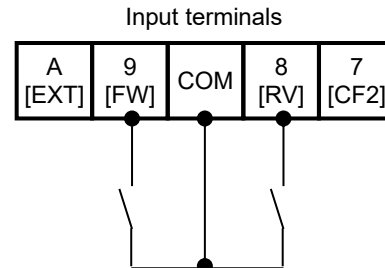

■ RUN and STOP command

Starts and stops by ON / OFF input of either [FW] terminal or [RV] terminal.

■ Parameter

Parameter	Setting function	Set value
[AA111]	[FW]/[RV] terminal	00
[CA-09]	Input terminal [9] function. (for [FW]).	001
[CA-08]	Input terminal [8] function. (for [RV]).	002

■ Frequency reference 3

11.2.5 Frequency with External Analog Input

- Select 01(Input Ai1 terminal) for [AA101] on the parameter setting screen.
- ※ The switch Ai1(SW1) on the control circuit board needs to be voltage.

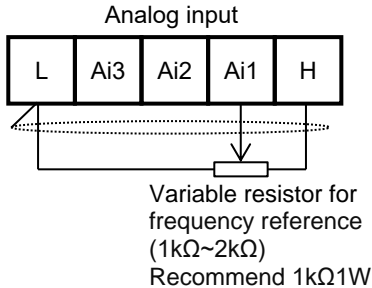

■ Frequency reference

- Changes the frequency reference by adjusting the position of variable resistor.

■ Parameter

Parameter	Setting function	Set value
[AA101]	Terminal[Ai1]	01

■ Frequency reference input from Ai2 terminal

- The Ai2 terminal is current input (4 to 20 mA) in the factory default condition, but can be switched to voltage input by setting the Ai2 switch (SW2) on the control board to the voltage side.
If you want to set the input voltage range to 0 to 10 VDC, change the parameter [Cb-15] from the initial value of 20.0% to 0.0%.
- To perform frequency reference by Ai2 terminal input, select [AA101] = 02 [Ai2] terminal input.

■ RUN command 3

11.2.6 RUN with the 3-Wire Method

- On the parameter setting screen, select 01 for [AA111]. In this paragraph, the 3-wire function is assigned to the input terminal below.

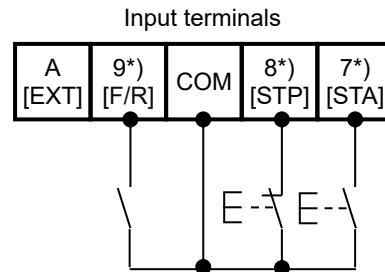

*) Terminal No. 7 [CA-07]=016, No. 8 [CA-08]=017, No. 9 [CA-09]=018.

(Note: When 017[STP] terminal function is assigned, it becomes B (NC) contact input.)



■ RUN and STOP command

- The motor starts rotating when the 016 [STA] is turned on while the 017 [STP] is on.
If the 017[STP] is turned off when the inverter is in running, the motor decelerate and then stop.
To restart, turn on 017 [STP] and then turn on 016 [STA] again.
The direction of rotation is selected with the 018[F/R].

■ Parameter

Parameter	Setting function	Set value
[AA111]	3-wire	01
[CA-09]	Input terminal [9] function. (for [F/R]).	018
[CA-08]	Input terminal [8] function. for [STP].	017
[CA-07]	Input terminal [8] function. (for [STA]).	016

Adjustment of I/O terminals - Example 1

11.2.7 Adjusting Analog Inputs (Ai1/Ai2)

E.g.1) Adjust operation (The frequency reference is set by [Ai1])

- The frequency reference range corresponding to the analog input can be set arbitrarily.

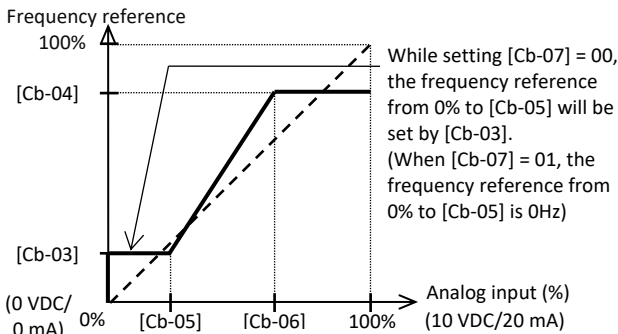

Parameter

Parameter		Details
Ai1	Ai2	
[Cb-03]	[Cb-13]	When the analog input is [Cb-05] / [Cb-15], sets the start frequency at the ratio that the maximum frequency setting becomes 100%.
[Cb-04]	[Cb-14]	When the analog input is [Cb-06] / [Cb-16], sets the end frequency at the ratio that the maximum frequency setting becomes 100%.
[Cb-05]	[Cb-15]	Sets the start ratio (%) between analog input 0 to 10 VDC / 0 to 20 mA.
[Cb-06]	[Cb-16]	Sets the end ratio (%) between analog input 0 to 10 VDC / 0 to 20 mA.
[Cb-07]	[Cb-17]	Sets whether the frequency reference from 0% to [Cb-05] / [Cb-15] is set to 0% or [Cb-03] / [Cb-13].

E.g.2) Fine setting (The frequency reference is set by [Ai1])

- If there is a deviation between the analog input and the frequency reference in the above [Cb-03] to [Cb-06] adjustment, fine adjustment is possible as follows. At first, set [Cb-03]/[Cb-13] to [Cb-06]/[Cb-16] to default values, and then adjust fine. Typically, adjust gain and bias setting within a few percent.

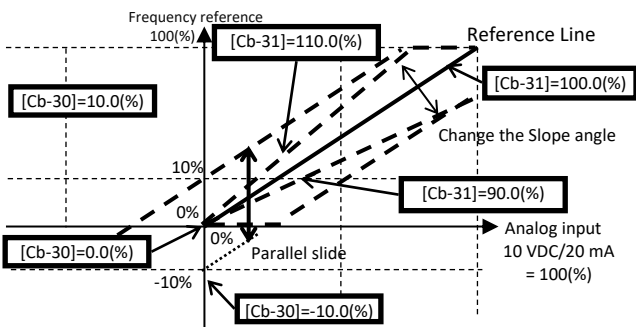

Parameter

Parameter		Details
Ai1	Ai2	
[Cb-30]	[Cb-32]	Fine adjustment of the analog input 0 V / 0 mA point is performed by adding the bias value to the frequency reference. Sets the ratio (%) with the Maximum frequency as 100%.
[Cb-31]	[Cb-33]	As shown above figure, fine adjustment is performed by multiplying the slope of the reference line by the gain. Sets the ratio (%) based on the (Maximum frequency / analog input (10 V / 20mA)) = 100%.

*) The voltage/current input is switched by the slide switch on the board.

*) For the adjustment of Ai2, read the above parameter Ai1 as Ai2.

Adjustment of I/O terminals - Example 2

11.2.8 Adjusting Analog Outputs (Ao1/Ao2/FM)

E.g.) Adjust operation ([Ao1] outputs the output frequency)

- Adjust the actual analog output by adding the bias [Cd-23] to the analog output when the output data is 0%.

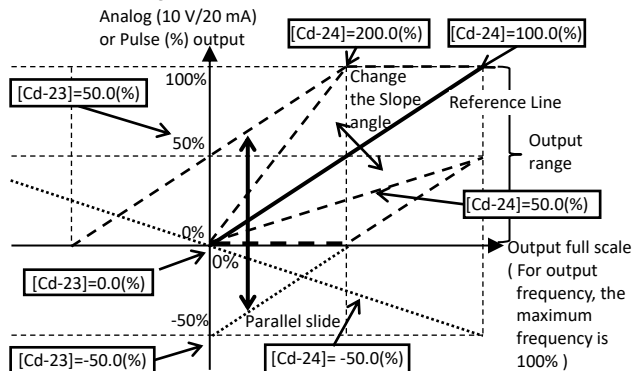

- Then, adjust the slope by multiplying the gain [Cd-24] to the reference line that (Analog output (10 VDC/20 mA) / output data full scale) is 100%, adjust the analog output when the output data is 100%.

Parameter

Parameter		Details
Ao1	Ao2	
[Cd-23]	[Cd-33]	The actual analog output is adjusted by adding a bias to the analog output when the output data is 0%. Sets the ratio (%) based on analog output (10V / 20mA) = 100%.
[Cd-24]	[Cd-34]	The {analog output (10V / 20mA) / output data full scale} = 100% is used as the reference line, and the actual analog output is adjusted by multiplying the slope by a gain.

- The output form of the FM terminal can select PWM output or digital frequency output by [Cd-01]. At PWM output, the pulse duty is calculated by t/T (%) (T = 6.4 ms constant), and t/T (%) = 100% at full scale of output data. At digital frequency output, t/T (%) is fixed at 50%, and the output pulse frequency at full scale output data is set by [Cd-02].

Parameter

Parameter		Details
FM		
[Cd-13]		Adjusts the actual pulse output by adding a bias to the pulse output when the output data is 0%. For PWM output, sets the ratio (%) based on the output duty (t/T) (%) = 100%. For digital frequency output, sets the ratio based on the setting frequency of [Cd-02] = 100%.
[Cd-14]		{Pulse output (%) / Output data full scale = 100%} is used as the reference line, and the actual pulse output is adjusted by multiplying the slope by a gain.

*) Analog output terminals Ao1/Ao2 can be switched to voltage or current output with the slide Switch on the control circuit terminal. Factory setting is Ao1=voltage output and Ao2=current output.

*) Adjustment for analog output Ao1 /Ao2 / FM are set with [Cd-01] to [Cd-35]. See section 12.25.4 to 12.25.6 of this Guide for details. (Note: In Ver2.02 or later, the initial value of Ao2 is 4 to 20 mA current output, and the [Cd-34] setting value has been changed from 100% to 80%. When using the analog output, be sure to check the related parameters and the slide switch on the board. And also, refer to the supplementary explanation at the end of guide.)

■ Adjustment of I/O terminals - Example 3

11.2.9 Adjusting Analog Input (Ai3)

E.g.) Adjust operation (The frequency reference is set by [Ai3])

- The frequency reference range corresponding to the analog input can be set arbitrarily.

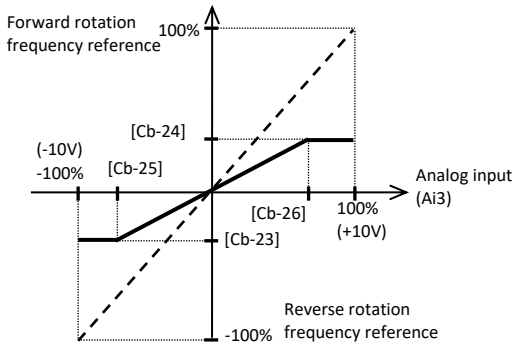

■ Parameter

Parameter	Details
Ai3	
[Cb-23]	Sets the start frequency when the analog input is [Cb-25]. Sets the ratio (%) with the maximum frequency as 100%.
[Cb-24]	Sets the end frequency when the analog input is [Cb-26]. Sets the ratio (%) with the maximum frequency as 100%.
[Cb-25]	Sets the start voltage between the analog input -10 and 10 VDC in the ratio (%) corresponding to -100 to 100%.
[Cb-26]	Sets the end voltage between the analog input -10 and 10 VDC in the ratio (%) corresponding to -100 to 100%.

E.g.2) Fine setting (The frequency reference is set by [Ai3])

- If there is a deviation between the analog input and the frequency reference in the above [Cb-23] to [Cb-26] adjustment, fine adjustment is possible as follows. At first, set [Cb-23] to [Cb-26] to default values, and then adjust fine. Typically, adjust gain and bias setting within a few percent.

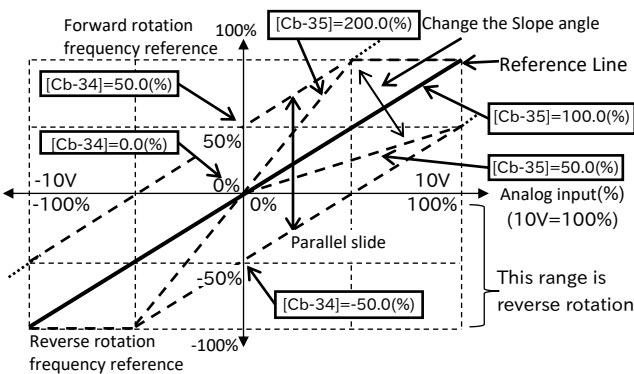

■Parameter

Parameter	Details
Ai3	
[Cb-34]	Fine adjustment of the analog input 0 V point is performed by adding the bias value to the frequency reference. Sets the ratio (%) with the Maximum frequency as 100%. If the frequency reference is negative, the rotation is reverse.
[Cb-35]	As shown above figure, fine adjustment is performed by multiplying the slope of the reference line by the gain. Sets the ratio (%) based on the (Maximum frequency / analog input (10V)) = 100%.

■ Adjustment of I/O terminals - Example 4

11.2.10 Prevention of Malfunction of Input Terminals

- Set a response time for input terminal to prevent from a malfunction due to noise or/and chatter.

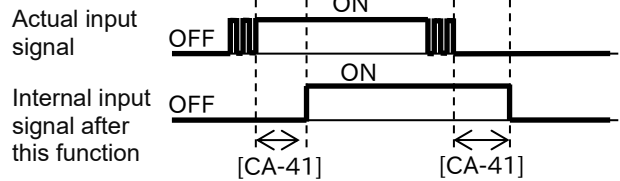

■ Parameter

Input terminal	Response time	Input terminal	Response time
1	[CA-41]	7	[CA-47]
2	[CA-42]	8	[CA-48]
3	[CA-43]	9	[CA-49]
4	[CA-44]	A	[CA-50]
5	[CA-45]	B	[CA-51]
6	[CA-46]		

■ Adjustment of I/O terminals - Example 5

11.2.11 Stabilization of Output Terminals

- Set the delay time to stabilize an output terminal from a sensitive reaction of internal functions.

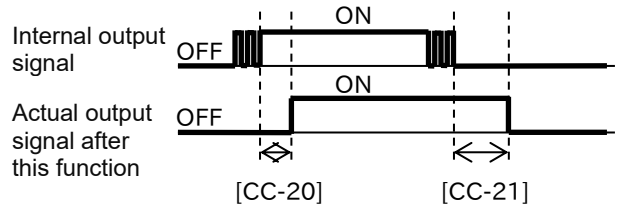

■Parameter

Output terminal	On-delay time	Off-delay time
11	[CC-20]	[CC-21]
12	[CC-22]	[CC-23]
13	[CC-24]	[CC-25]
14	[CC-26]	[CC-27]
15	[CC-28]	[CC-29]
16A-16C	[CC-30]	[CC-31]
AL1-AL0/ AL2-AL0	[CC-32]	[CC-33]

12

Chapter 12 Inverter Functions

12.1 What This Chapter Explains

This chapter describes various functions of the inverter. Select a function that you want to use and configure it.

Make sure to carefully read “Chapter 1 Safety Instructions/Risks” for safety work.







Caution

- Wrong parameter setting could cause unexpected operation and result in a dangerous situation.



Do

- Check and carefully read “Chapter 1 Safety Instructions/Risks” again before setting parameters. Carefully read a note for each parameter.

Symbol	Meanings
	General and troubleshooting questions
	Key points for a solution
	Notes
	Confirmation of procedures

- Search a function to use.



- Show the content of this chapter.

Chapter	Item	Page
12.2	Basic Settings of Inverter	12-2-1
12.3	Basic Settings of Motor	12-3-1
12.4	Selection of Frequency Reference	12-4-1
12.5	Selection of RUN Command	12-5-1
12.6	Limits to Frequency Reference and RUN Command	12-6-1
12.7	Temperature Protection of Motor	12-7-1
12.8	Using Functions of Accelerating or Decelerating Motor Speed	12-8-1
12.9	Select the Appropriate Control Mode for the Motor and Load	12-9-1
12.10	Perform Process Control Suitable for the System Using PID Control	12-10-1
12.11	Perform Torque Control Suitable for the Load	12-11-1
12.12	Adjustments for Motor Electromagnetic Sound Noise, Electrical Noise, Heat Generation of Inverter	12-12-1
12.13	Functions to Prevent Trips or Restart on Trips	12-13-1
12.14	Each Start Mode Settings	12-14-1

Chapter	Item	Page
12.15	Each Stop Mode Settings	12-15-1
12.16	Using System Protection Functions	12-16-1
12.17	How to Use the Functions Interlock to the System	12-17-1
12.18	Controlling the Cooling Fan of the Inverter	12-18-1
12.19	How to Output Warning Signals	12-19-1
12.20	How to Output Running Status Related Signals	12-20-1
12.21	How to Output the Output Frequency Specific Condition Signals	12-21-1
12.22	How to detect Analog Inputs Disconnection or Out-of-Range	12-22-1
12.23	How to Output the Logical Operation of Two Output Signals	12-23-1
12.24	Functions with Input Terminal Signal	12-24-1
12.25	Functions with Output Terminal Signal	12-25-1

12.2 Basic Settings of Inverter

12.2.1 Change Duty Rating of Inverter



- I want to change the duty rating mode to the one checked in selecting the mode.
- I want to lower the capacity of the inverter against the motor since the duty of the fan or pump is small.
- I want to use the inverter for a lift or others with a heavy duty.



- The duty rating mode of the inverter can be chosen from Normal Duty (ND), Low Duty (LD), and Very Low Duty (VLD). See “Difference in duty rating modes” in the following.
- The rated current, excess duty endurance, and rated temperature of the inverter could change depending on the duty rating mode.
- A change of the inverter duty rating mode is reflected immediately after the [Ub-03] Load type selection is changed.



- When [Ub-03] is changed, the parameter set for the electric current is automatically adjusted at the ratio of the changed rated current and the set value is changed accordingly.
- If the current setting is changed by using the overload restriction function, the DC braking function, the electronic thermal function, the overload notice advance signals, Low current detection levels or etc., check again the current setting parameters.
- When VLD is selected and the control mode is selected out of the VLD specification range with the [AA121] Control mode selection, the control mode is automatically set to the V/f control. Another check is necessary when the control type setting is changed.

Parameters

Item	Parameters	Data	Description
Load type selection	[Ub-03]	00	VLD (Very Low Duty)
		01	LD (Low Duty)
		02	ND (Normal Duty)

Difference in duty rating modes

Duty rating	ND (Normal Duty)	LD (Low Duty)	VLD (Very Low Duty)
Overload current rating	150% (1 min.) / 200% (3 sec.)	120% (1 min.) / 150% (3 sec.)	110% (1 min.) / 120% (3 sec.)
Temperature characteristics	50 °C (with derating)	45°C (with derating)	40°C (with derating)
Corresponding control type *)	Induction motor IM <ul style="list-style-type: none"> • V/f control • V/f control with encoder • Sensorless vector control (SLV) • 0 Hz-range SLV control (IM-0Hz-SLV) • Vector control with encoder (CLV) Synchronous motor SM <ul style="list-style-type: none"> • Sensorless vector control (• Synchronous start type SLV , • IVMS start type SLV) 	Induction motor IM <ul style="list-style-type: none"> • V/f control • V/f control with encoder • Sensorless vector control (SLV) Synchronous motor SM <ul style="list-style-type: none"> • Sensorless vector control (• Synchronous start type SLV , • IVMS start type SLV) 	Induction motor IM <ul style="list-style-type: none"> • V/f control • V/f control with encoder • Sensorless vector control (SLV) Synchronous motor SM <ul style="list-style-type: none"> • Sensorless vector control (• Synchronous start type SLV)
Major applications	Lifts, cranes, etc. Conveyors, transportation machines, etc. Fans, pumps		

*) V/f control with sensor and vector control with sensor require encoder feedback to the P1-FB option or the input terminals [A] and [B].



- The inverter rating is changed.

1 Press right (▶) key on the display screen.

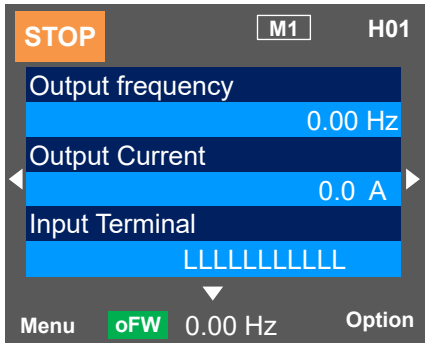

2 Press SEL(o) key twice on the parameter setting display screen and the parameter area begins blinking.

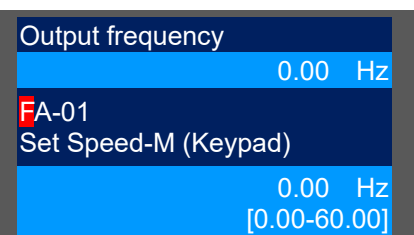
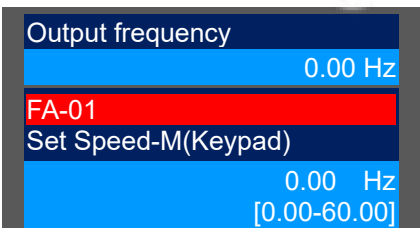
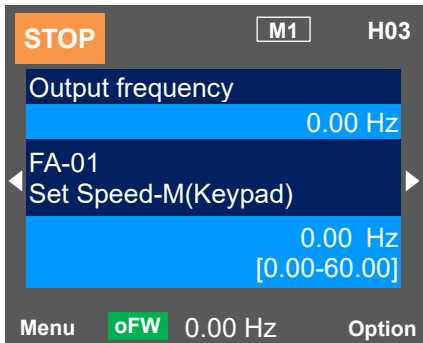

3 Use up, down, right, and left keys to choose a parameter and SEL(o) key to set it.

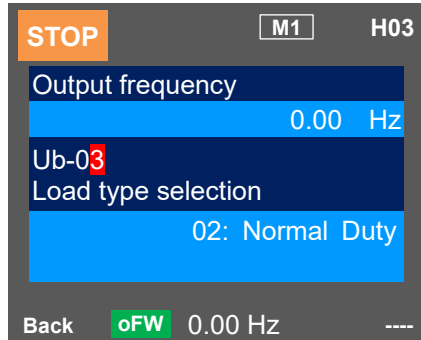

4 Use up and down keys to choose a mode and F2(2) key to set it.

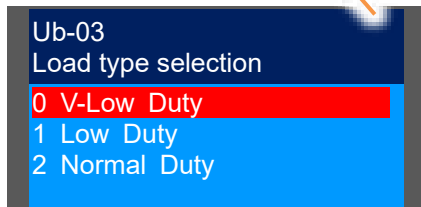
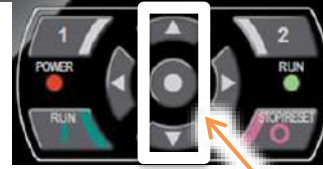
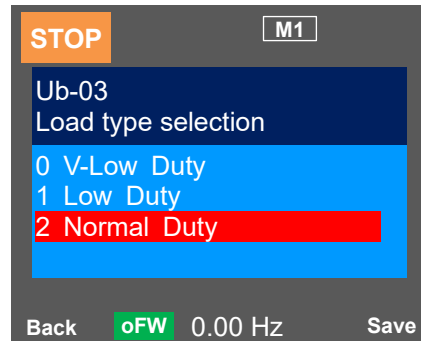

* The change operation is performed and the data is stored.

5 Check the content on the previous screen. If the content is changed, the change is supposed to be stored in the storage element and the mode is switched.

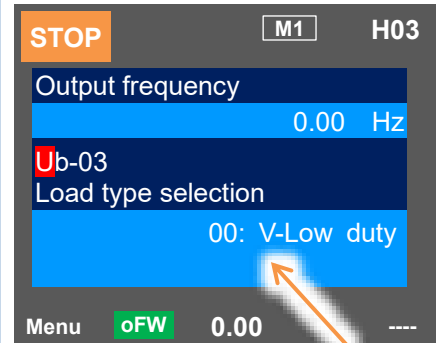

12.2.2 Initialization of Inverter



- I want to initialize the setting.
- I want to return to the factory setting.
- I want to initialize the setting except the input / output terminal functions setting.
- I want to initialize the setting except the communication setting.
- I want to clear the trip history only.



- Load type selection [Ub-03] is not initialized.
- The initialization sets the parameters to initial values. If the data before the initialization are necessary, read the data using the Read/Write function (Read) on the operator keypad VOP or use PC software ProDriveNext to save the data on a PC.



- When the Initialize mode selection [Ub-01] is chosen and then the Enable initialization [Ub-05] is set to 01, the designated data can be initialized to the factory setting.
- Only the trip history can be cleared without initialization of the stored parameter values.

- Initial values to be stored after the initialization can be changed by changing the Initialize data selection [Ub-02]. For details of the modes, refer to “Appendix List of Parameters” in this Guide.

Parameters

Name	Code	Data	Description
Initialize mode selection	[Ub-01]	00	The initialization is disabled.
		01	The trip history and retry history are cleared.
		02	All the parameters are all initialized.
		03	The trip history, retry history, and all parameters are initialized.
		04	The trip history, retry history, all parameters, and program data for EzSQ are initialized.
		05	Parameters except I/O terminal functions are initialized.
		06	Parameters except communication function are initialized.
		07	Parameters except I/O terminal functions and communication function are initialized.
Initialize data selection	[Ub-02]	00	Mode 0
		01	Mode 1
		02	Mode 2
		03	Mode 3
Enable initialization	[Ub-05]	00	Function disabled
		01	Execute initialization

Content of [Ub-01] Initialize mode selection

Item	Parameter range	Description
Classification of I/O terminal functions	[CA-01] to [CA-11]	Input terminal function
	[CA-21] to [CA-31]	a/b (NO/NC) contact selection
	[CA-41] to [CA-51]	Input terminal response time
	[Cb-40]	Thermistor type selection
	[CC-01] to [CC-07]	Output terminal function
	[CC-11] to [CC-17]	a/b (NO/NC) contact selection
	[CC-20] to [CC-33]	Output terminal on/off-delay time
	[CC-40] to [CC-60]	Logical operation function

Item	Parameter range	Description
Classification of communication functions	[CF-01] to [CF-08]	Setting of RS485 communication
	[CF-20] to [CF-38]	Setting of EzCOM communication

■ Table of initialization targets

[Ub-01] Initialize mode selection:

Initialization targets are indicated by ■.

[Ub-01]	(1) Trip and Retry history data	(2) Setting of I/O terminal	(3) Communication function	(4) Other than parameters (2) and (3)	(5) EzSQ
00					
01	■				
02		■	■	■	
03	■	■	■	■	
04	■	■	■	■	■
05			■	■	
06		■		■	
07				■	
08					■



- Example of initialization of the trip history, all the parameters, and the program data for EzSQ

1 Press right (▶) key on the display screen.

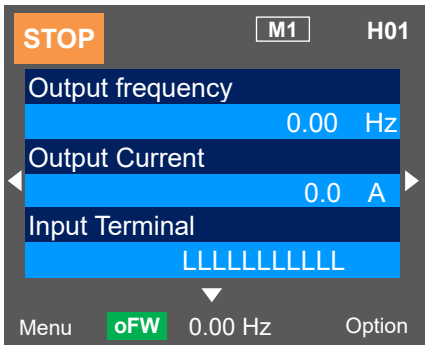

2 Press SEL(o) key twice on the parameter setting display screen and the parameter area begins blinking.

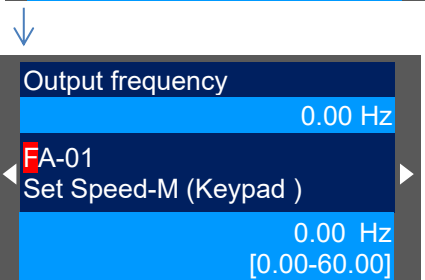
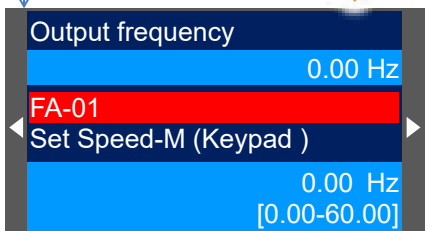
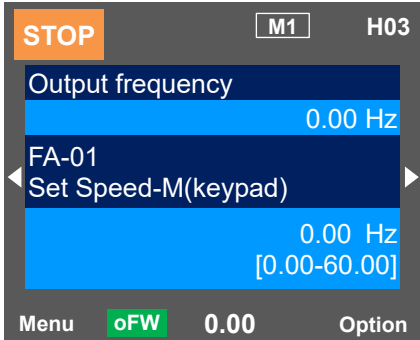

3 Use up, down, right, and left keys to choose a parameter and SEL(o) key to set it.

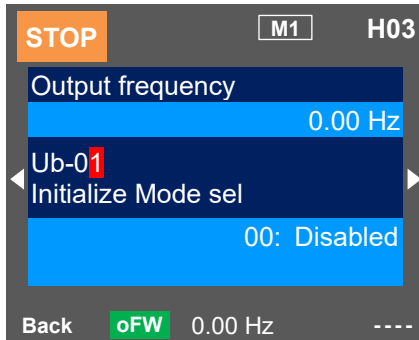

4 Use up and down keys to choose a mode and F2(2) key to set it.

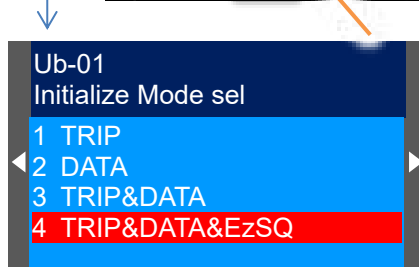
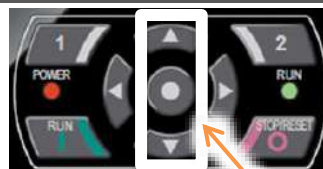
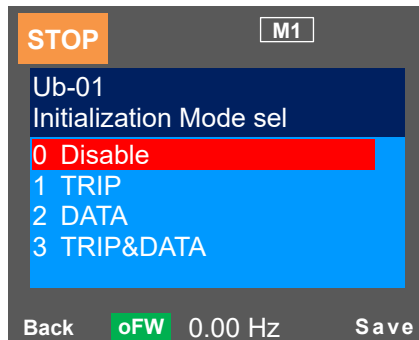

5 Check the content on the previous screen. The initialization is not done yet.

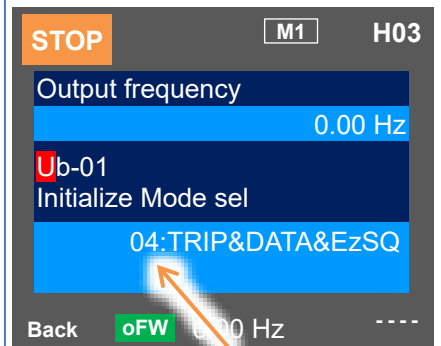

6 Next, use up, down, right, and left keys to choose [Ub-05] and SEL(o) key to set it.

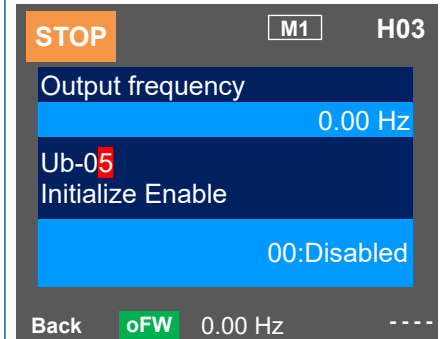

7 Choose "1 Initialize" and press F2(2) key and initialization begins.

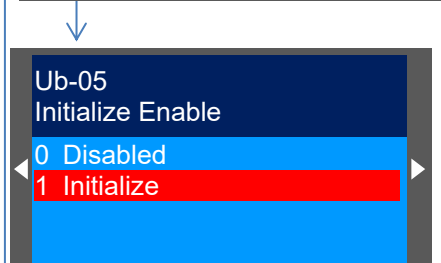
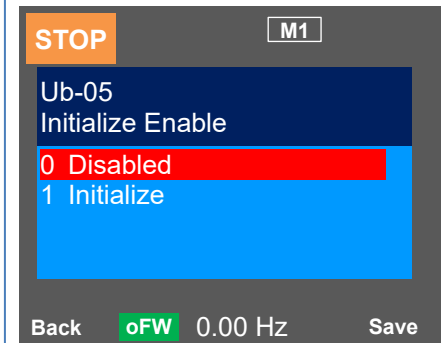

8 Initialization is on-going.



9 When the initialization is completed, "Initialization is complete!" is displayed.

(Memo)

12.3 Basic Settings of Motor

12.3.1 Parameter Settings of Motor Rating Data

Q

- I want to make appropriate settings for the motor.
- I want to stabilize the motor drive.

A

- Basic parameters to control and protect the motor are set.
- The following basic parameters need to be set for any control type.
- The motor operation could be stabilized if the motor items are set to the inverter.
- The induction motor (IM) and synchronous motor (SM) / permanent magnet motor (PMM) are set separately.

■ About induction motor (IM)

Name	Code	Data range (unit)	Description
Async. Motor capacity setting, 1st-motor	[Hb102]	0.01 to 160.00 (kW) (P1-550L/P1-1320H or under) 0.01 to 500.00(kW) (P1-1600H or over)	Sets the motor capacity.
Async. Motor number of poles setting, 1st-motor	[Hb103]	0 to 23 (02 to 48 poles)	Sets the number of motor poles.
Async. Motor base frequency setting, 1st-motor	[Hb104]	10.00 to [Hb105] (Hz)	Sets the base frequency of motor.
Async. Motor maximum frequency setting, 1st-motor	[Hb105]	[Hb104] to 590.00 (Hz)	Sets the max. frequency of motor.
Async. Motor rated voltage, 1st-motor	[Hb106]	1 to 1000 (V)	Sets the rated voltage of motor.
Async. Motor rated current, 1st-motor	[Hb108]	0.01 to 10000.00 (A)	Sets the rated current of motor.

■ About synchronous motor (SM) / permanent magnetic motor (PMM)

Name	Code	Data range (unit)	Description
Sync. Motor capacity setting, 1st-motor	[Hd102]	0.01 to 160.00 (kW) (P1-550L/P1-1320H or smaller) 0.01 to 500.00 (kW) (P1-1600H or larger)	Sets the motor capacity.
Sync. Motor number of poles setting, 1st-motor	[Hd103]	0 to 23 (02 to 48 poles)	Sets the number of poles.
Sync. Motor Base frequency setting, 1st-motor	[Hd104]	10.00 to [Hd105] (Hz)	Sets the base frequency of motor.
Sync. Motor Maximum frequency setting, 1st-motor	[Hd105]	[Hd104] to 590.00 (Hz)	Sets the max. frequency of motor.
Sync. Motor rated voltage, 1st-motor	[Hd106]	1 to 1000 (V)	Sets the rated voltage of motor.
Sync. Motor rated current, 1st-motor	[Hd108]	0.01 to 10000.00 (A)	Sets the rated current of motor.



The motor could burn if the base frequency is set smaller than the motor frequency. (Smaller than 50/60 Hz in case of standard induction motor)



The motor could burn if the max. frequency and rated voltage are set out of the range specified in the motor specifications.



For setting the max. frequency larger than 60 Hz, contact the motor manufacturer about allowed max. frequency.



After initialization, the motor protection function needs to be configured again. Otherwise, the motor could burn.

■ Capacity and number of poles

A

- The inverter reads out preset standard motor data if the capacity and number of poles are changed.
- The motor disturbance could be suppressed and the motor operation could be stabilized if the capacity and number of poles are correctly set.

■ Base frequency

A

- Set the base frequency according to the motor specifications.



- The induction motor should be regarded as a special one if used at higher than 60 Hz. In this case, the inverter capacity may need to be made larger as the maximum capacity of the inverter motor is incorrect.

■ Max. frequency

A

- Sets the max. frequency of motor to use.

■ Rated voltage

A

- Set the rated voltage of motor according to the motor specifications.

!

- Expected characteristics may not be obtained if the motor rated voltage is set higher than receiving voltage or inverter rated voltage.
- Set the rated voltage of motor in the following way if the inverter is switched from SJ700/ L700.
(Note: A082 and A045 are parameters of SJ700/L700)
 $[Hb106]=A082 \times A045 / 100$

■ Rated current

A

- Set the rated current of motor according to the motor specifications. Inappropriate setting could disturb the motor protection.
- The motor control could become unstable unless the motor rated current is correctly set.

!

- Expected characteristics may not be obtained if the motor rated current is set higher than the inverter rated current. In some cases, the inverter protection works first.

Automatic voltage regulation function (AVR function)

A

- The inverter automatically operates the automatic voltage regulation function (AVR function). This function outputs voltage to the motor correctly even with variation in the input voltage to the inverter.
- Output of a voltage larger than the input voltage is not allowed even using this function.

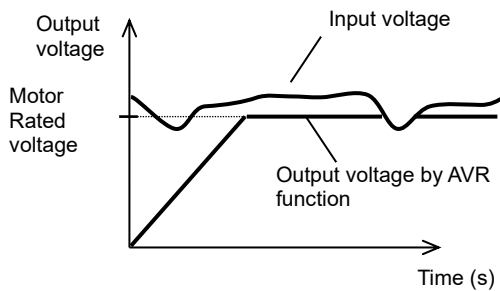

A

- To use operation with conventional AVR function being set OFF, make the setting in the over-magnetization function selection [bA146].
- [bA146]=02 for AVR OFF during deceleration.
- [bA146]=01 for AVR OFF all time.

Relation between frequency and voltage under general V/f control (IM)

A

- General V/f control characteristic is given in the following with the base frequency and rated voltage being set.
- At the frequency in the range from the base to max. frequency, the output voltage reaches a max. of the rated voltage of motor.

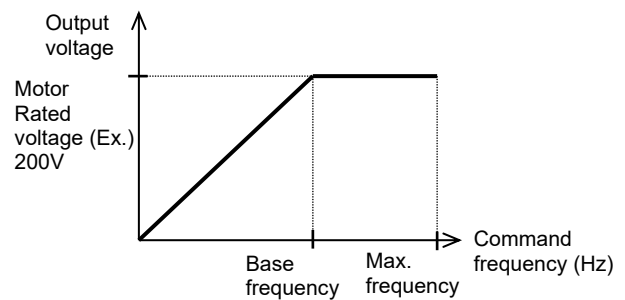

Control of general synchronous motor (SM/PMM)

!

- Basically the synchronous motor (SM/PMM) needs current calculation control and the motor parameters need to be set. The parameters in this item and motor constants in the next item need to be set.

12.3.2 Motor Constant Settings

Q

- I want to stabilize the motor drive.
- I want to use a motor other than Hitachi's.
- I want to use the vector control function.
- I want to use the automatic torque boost function.

!

- Note that the motor constants will be overwritten or initialize if any of the following actions is taken. This applies to

In case of IM:

- The motor capacity or number of motor poles is changed.
- The auto-tuning is performed.
- The initialization is performed.

In case of SM (PMM):

- The motor capacity is changed.
- The auto-tuning is performed.
- The initialization is performed.

Please be advised to save the motor constants using the Read/Write function on the operator keypad VOP.

- For details of adjustment, see "12.9.1 Selection of control mode".

A

- The motor operation could be stabilized if the following operations are made.
- In particular, the motor constants need to be set according to the motor specifications when the automatic torque boost control, automatic torque boost control with sensor, sensorless vector control, 0 Hz-range sensorless vector control, or vector control with sensor is used.
- The motor constants of Hitachi's standard motor are automatically set to the followings when the motor capacity or number of motor poles is changed.
- Some of the motor constants in the followings are automatically set to acquired constant data when the auto-tuning function is used. For details, see the next section.
- The motor constants can be chosen from the motor constant selection or manually changed or adjusted.
- Hitachi's IE3 motor constants are used as initial values of the induction motor (IM) constants.

■ IM motor constant parameters

Name	Code	Data range (unit)	Description
Async. Motor constant R1, 1st-motor	[Hb110]	0.000001 to 1000.000000 (Ω)	Sets the primary resistance of IM.
Async. Motor constant R2, 1st-motor	[Hb112]	0.000001 to 1000.000000 (Ω)	Sets the secondary resistance of IM.
Async. Motor constant L, 1st-motor	[Hb114]	0.000001 to 1000.000000 (mH)	Sets the leakage inductance of IM.
Async. Motor constant I0, 1st-motor	[Hb116]	0.01 to 10000.00 (A)	Sets the no-load current of IM.
Async. Motor constant J, 1st-motor	[Hb118]	0.00001 to 10000.00000 (kgm ²)	Sets the moment of inertia of the system.

!

- Set the motor constant I0 in the following way if the inverter is replaced from SJ700.
[Hb116]=(50Hz/A003)×H023 (or H033)
- When the base frequency is changed, the reference value of the motor constant I0 changes and I0 is considered that there is a change (the set value is maintained). In this case, obtain the correct value by auto tuning function.
Or, when using a Hitachi standard induction motor (IE3), by setting the [Hb103] pole number selection to a different value (temporarily change 4 poles to 2 poles and then to set 4 poles again), the motor constant values are initialized and the [Hb116] motor constant I0 corresponding to the changed base frequency is set.

■ SM/PMM motor constant parameters

Name	Code	Data range (unit)	Description
Sync. Motor constant R, 1st-motor	[Hd110]	0.000001 to 1000.000000 (Ω)	Sets the resistance of SM/PMM.
Sync. Motor constant Ld, 1st-motor	[Hd112]	0.000001 to 1000.000000 (mH)	Sets the d-axis inductance of SM/PMM.
Sync. Motor constant Lq, 1st-motor	[Hd114]	0.000001 to 1000.000000 (mH)	Sets the q-axis inductance of SM/PMM.
Sync. Motor constant Ke, 1st-motor	[Hd116]	0.1 to 100000.0 (mVs/rad)	Sets the calculated value of induced voltage of SM/PMM.
Sync. Motor constant J, 1st-motor	[Hd118]	0.00001 to 10000.00000 (kgm^2)	Sets the moment of inertia of the system.



- The base (max.) frequency can be calculated from the rated number of revolutions of the motor (min^{-1}) and the number of poles in the following formula.

$$\text{Base (max.) frequency (Hz)} = \text{rated number of revolutions (min}^{-1}\text{)} \times \text{number of poles (pole)} / 120$$

- The motor constant Ke is the peak value of the phase induced voltage (mV) per electrical angular speed (rad/s).

12.3.3 Auto-Tuning of Motor

Q

- I want to use a motor other than Hitachi's.
- I want to stabilize the motor drive.
- I want to readjust because the motor environment has changed.
- I want to readjust because the wiring are changed after TEST RUN.
- I want to readjust because the motor and/or wiring are replaced.

A

- The auto-tuning is a function that measures and automatically sets the motor constants necessary for the motor control that the Control mode selection [AA121] is set to 03, 07 to 12 (Auto torque boost, Sensorless vector control, Zero-Hz-range sensorless vector control, Vector control).
- There are two types of auto-tuning functions below:
 - Offline auto-tuning which the auto-tuning function finishes after a single measurement.
 - Online auto-tuning which the auto-tuning function measures a change in the constants due to motor temperature increase every time the motor is started or stopped.
- Use the offline auto-tuning to measure the motor constants if you use a motor whose constants are unknown.
- The online auto-tuning can stabilize the motor behavior by correcting the temperature increase of the motor during operation.

■ Parameters

Name	Code	Data	Description
Auto-tuning selection	[HA-01]	00	Function disabled.
		01	No-rotation auto-tuning is performed. After this parameter is set, tuning is started by inputting an RUN command.
		02	Rotation auto-tuning is performed. After this parameter is set, tuning is started by inputting an RUN command.
		03	The tuning for the IVMS control type is performed. After this parameter is set, tuning is started by inputting an RUN command.
Auto-tuning RUN command source selection	[HA-02]	00	RUN key on the operator keypad.
		01	Depending on the RUN command input source selection [AA111].
Online auto-tuning selection	[HA-03]	00	Function disabled.
		01	The online tuning is performed. The online tuning is automatically performed after the deceleration stops in ordinary operations.



• When 02 (Rotation) is chosen in the Auto-tuning selection [HA-01], the motor automatically begins rotating when the tuning starts.
Make sure of the followings.

- There is no problem even if the rotation is about 80% of the base frequency.
- The motor does not move due to external drive source, external force or etc.
- The braking should be in the open state.



Do



- The torque is not high enough during the auto-tuning. Lift or other machine could have unexpected slipping. Remove the motor from the machine and perform auto-tuning with motor alone. (In this case, the moment of inertia is only for the motor. In actual operation, set the moment of inertia J by adding the load moment of inertia converted to the motor axis.)



Do



- For a machine with limited motor axis rotation (lift, ball screw, etc.), 01 (No-rotation) should be chosen in [HA-01] since rotation higher than the allowed one could occur causing a damage to the machine.



Do



- The constants of Hitachi's standard induction motor (IE3 motor) are used as default in the factory setting. If you use Hitachi's standard induction motor, expected characteristics will be achieved without offline auto-tuning in most cases .
- Smooth tuning could be done if the offline auto-tuning is first performed for the factory-set parameters.
- If a synchronous motor SM (or permanent magnet motor PMM) is used, perform the tuning after the Control mode selection [AA121] is set to 11 (Synchronous start type sensorless vector control(SM/PMM)) or 12 (IVMS start type sensorless vector control (SM/PMM)). But if the Load type selection [Ub-03] is selected LD/VLD, the control mode selection [AA121] can be set 11 only.
- If expected characteristics cannot be achieved, adjust the parameters and motor constants.
- Perform the offline auto-tuning before using the online auto-tuning function.
- The motor constants are for the single phase of Y-connection.
- The offline auto-tuning is performed only when the operation (current can be output to the motor) is possible.
- Even if 02 (No-rotation) is selected in [HA-01], set the no-load current value of the induction motor to [Hb116] in advance. If no-load current is not known, check the current during operation which state is no load, V/f control and the rotation at the base frequency by output current monitor [dA02]. And then input it to the [Hb116] before the auto-tuning.
- Even if 01 (No-rotation) is chosen for [HA-01], the motor could rotate slightly.
- The offline auto-tuning automatically overwrites the parameters with acquired data. The online auto-tuning does not overwrite the parameters with the data as it corrects internal data.
- Do not perform online auto-tuning for heavy acceleration / deceleration operation with heavy load such as inching operation by lift. The over-current error etc. could occur.

■ Parameter data overwritten in the offline auto-tuning

Selection of IM/SM	Parameters to be overwritten	
	Non-revolving tuning [HA-01]=01	Revolving tuning [HA-01]=02
Induction motor (IM) control [AA121]=00 to 10	[Hb110] Async. Motor constant R1 [Hb112] Async. Motor constant R2 [Hb114] Async. Motor constant L	[Hb110] Async. Motor constant R1 [Hb112] Async. Motor constant R2 [Hb114] Async. Motor constant L [Hb116] Async. Motor constant I0 [Hb118] Async. Motor constant J
Control of synchronous motor (permanent magnetic motor) (SM (PMM)) [AA121]=11 to 12	[Hd110] Sync. Motor constant R [Hd112] Sync. Motor constant Ld [Hd114] Sync. Motor constant Lq	-

*The above table shows the case where [SET] terminal is OFF or not selected. If [SET] terminal is made ON and the secondary setting is used, the parameters of [H*21*] ([Hb210], [Hd210], etc.) are effective and overwritten according to the [AA221] Control mode selection 2nd-motor.

■ IVMS auto-tuning



- If a high torque is necessary for start up, try to use the Hitachi's original IVMS control. By setting the Auto-tuning selection [HA-01] to 03 and executing it, it can detect whether the target motor can be driven by the IVMS control method, but it is necessary to check the combination with the motor in advance. Please contact our sales office for details.
- The tuning with the IVMS control should be performed on an motor single body with the control type [AA121] set to 12 (SM/PMM: IVMS activation).
- In case of failure of the auto-tuning with the IVMS control, data necessary for the IVMS control cannot be obtained from the motor and the Control mode selection [AA121] should be set to 11 (Synchronous start type sensorless vector control(SM/PMM)) to drive the motor.



Offline auto-tuning

1

Check the Control mode selection [AA121].

For the induction motor (IM), make sure that the Control mode selection [AA121] is set to the one for IM. For the synchronous motor (SM) or permanent magnetic motor (PMM), make sure that the control type [AA121] is set to the one for PMM.

2

Set the Auto-tuning selection [HA-01].

In the auto-tuning selection [HA-01], 01: No-rotation or 02: Rotation is set. The tuning does not begin at this stage. Only "No-rotation" can be chosen for synchronous motor (SM) / permanent magnetic motor (PMM).

3

Input a RUN command for tuning.

Pressing RUN button on the operator keypad starts the tuning. Pressing STOP button interrupts the tuning, however tuning data are not saved.

4

The inverter automatically operates.

Output of a preset pattern is given to the motor. If the Auto-tuning selection [HA-01] is set to 01: No-rotation, three patterns of non-rotating output are performed.

If the Auto-tuning selection [HA-01] is set to 02: Rotation, in addition to the above 3 patterns, the acceleration / deceleration operation is repeated twice. The output frequency rises up to 80% of the base frequency.

After the above, non-rotating output is performed again for final confirmation.

5

The tuning finished.

When the tuning End display appears, the tuning finishes. Use STOP key to cancel the End display.



Online auto-tuning

1

Perform the offline auto-tuning.

Since the online auto-tuning operates with the set motor constants, perform the offline auto-tuning shown on the left in advance.

2

The Online auto-tuning selection [HA-03] is set.

Set the Online auto-tuning selection [HA-03] to 01: Enabled.

3

Check the online auto-tuning.

The online tuning operates for a maximum of 5 sec at the timing of deceleration stop during the inverter running. Make sure that your system can be started and stopped normally before starting online tuning.



- In case of termination due to trip or erroneous tuning, correct data cannot be acquired. See the next page.
- The result of the online tuning is automatically reflected in up to 5 sec after the stop. It is not reflected if the operation is restarted during the tuning.
- The online tuning is not performed if the servo-on function 065[SON] or forcing function 066[FOC] is working.
- In the factory setting, the offline auto-tuning can be started by the RUN key on the operator keypad. It can be changed to the RUN command input source selection [AA111] by changing the Auto-tuning RUN command source selection [HA-02] to 01.

■ Tuning failure during auto-tuning.

Expected causes▶	Examples of measures
<ul style="list-style-type: none"> The control type is not suitable for the motor. 	<ul style="list-style-type: none"> Since the tuning method is determined by whether the Control mode selection [AA121] is IM control or SM/PMM control, set the type in accordance with the motor.
<ul style="list-style-type: none"> The base frequency, motor rated voltage, or motor rated current is not suitable for the motor specifications. 	<ul style="list-style-type: none"> Since wrong basic parameters of the motor could cause over current trip or etc., check the basic parameters and set them appropriately.
<ul style="list-style-type: none"> STOP key was pressed. 	<ul style="list-style-type: none"> Pressing the STOP key on the operator keypad interrupts the auto-tuning. Check the setting of the auto-tuning again before starting the tuning.
<ul style="list-style-type: none"> External factors such as braking caused a trip. 	<ul style="list-style-type: none"> Factors that cause the trip need to be removed.
<ul style="list-style-type: none"> The input terminal function worked. 	<ul style="list-style-type: none"> The tuning could be disturbed if the input terminal function works during the auto-tuning.
<ul style="list-style-type: none"> The motor capacity is too small compared to the applicable inverter model. 	<ul style="list-style-type: none"> If the tuning does not finish correctly, the motor constants need to be set manually.



- In case of failure of the auto-tuning, the motor constant data are not updated and the motor works in the untuned state.

12.4 Selection of Frequency Reference

12.4.1 Type of Frequency Reference

A

- The frequency reference selected in each function is enabled.
- For details, see the next and subsequent sections.
- The value of the enabled frequency reference is shown in [FA-01]. If the frequency reference can be modified on the operator keypad, the modification is made by changing [FA-01] when, for example, [AA101]=07 is effective. ([Ab110] is overwritten when [FA-01] is changed.)

!

- The operation of the inverter requires not only a frequency reference but also a RUN command.
- To use the second setting switching [SET] of the input terminal function, replace 1 of the third digit of the parameter with 2. Ex.: [AA101]->[AA201]. If the third digit is "-", the parameter is shared for the first and second settings.

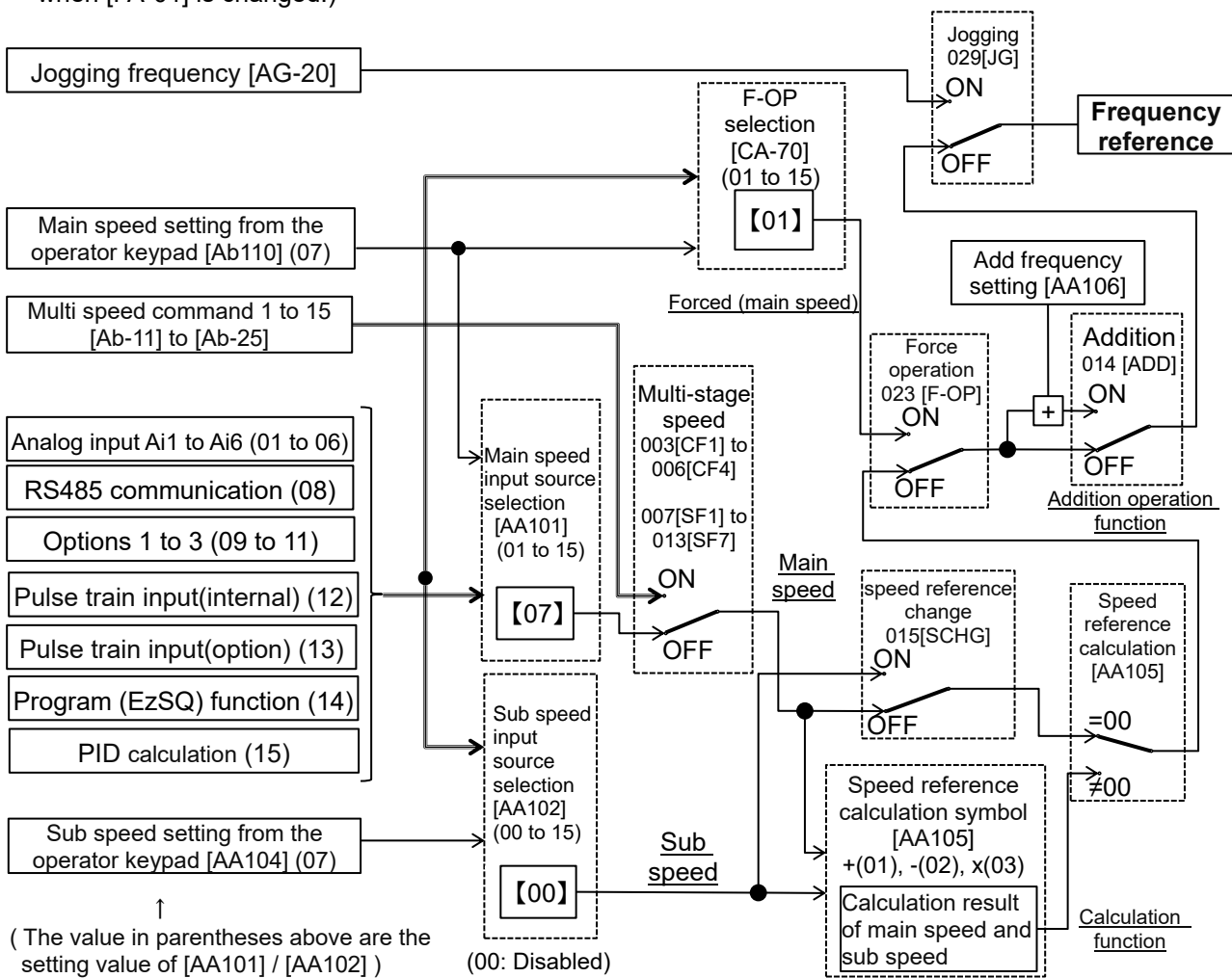

(The value in parentheses above are the setting value of [AA101] / [AA102])

(The value of [] and the position of the switch diagram are the initial values of each setting. (In case [Ub-01] = 00))

!

- In the above example, [AA101]=07 (operator keypad) is enabled. For details, see the following section 12.4.2.
- Other command sources can be chosen even when RS485 (Modbus communication, EzCOM function) and program function (EzSQ) are being used.
- If a RUN command is given from the operation screen of PC software ProDriveNext, [AA101]=07 and [AA111]=03 are forcibly overwritten when the operation screen opens. When the operation screen closes, the values returned to the ones used before the screen opened.
- Functions not assigned to the input terminal functions [CA-01] to [CA-11] become OFF.

12.4.2 Operation on Operator Keypad

Q

- I want to change the frequency from the operator keypad at TEST RUN
- I want to change the frequency while watching it on the monitor of keypad.
- I want to change the motor speed using the operator keypad.

A

- The operator keypad is used to give a frequency reference.
- For operation using the operator's keypad, the operation direction can be changed by setting the RUN-key command rotation direction [AA-12].

!

- The output of the inverter (operation of the motor) requires not only a frequency reference but also an operation command.
- The main and Sub speeds can be selected and calculated by using the input terminal function [SCHG] and the calculation function. For details, see "12.4.9 Selection or Calculation from Two Frequency References"
- If not using the operator keypad, you need to make FW/RV direction switching from each command.

■ Parameters

Name	Code	Data range (unit)	Description
Main speed input source selection, 1st-motor	[AA101]	07	The frequency set from the operator keypad is for main speed. In this case the setting is made for [Ab110].
Sub speed input source selection, 1st-motor	[AA102]	07	Set the sub speed when using the switching and calculation functions from the operation keypad. For Sub speed, the setting is made for [AA104].
Multi-speed 0 setting, 1st-motor	[Ab110]	0.00 to 590.00(Hz)	Frequency setting of the main speed on the operator keypad. Shared for the 0th speed of the multi-stage speed function.
Sub speed setting, 1st-motor	[AA104]	0.00 to 590.00(Hz)	Frequency setting of the sub speed on the operator keypad.
RUN-key command rotation direction	[AA-12]	00	Forward rotation operation
		01	Reverse rotation operation
Output terminal function	[CC-01] to [CC-07]	010	[FREF] turns ON if the frequency reference can be input from the operation keypad.

12.4.3 Operation with Analog Signal from Terminal Block

■ Enabling frequency reference from terminal block



- I want to give a frequency reference from an external device.
- I want to use a frequency setter to change the frequency.
- I want to connect a variable resistor to change the frequency.



- A frequency reference is given by input from the terminal block.
- The inverter has three kinds of external analog input.

Terminal connection	Input range	Switching method
Ai1-L	0 to 10 VDC / 0 to 20 mA switchable	SW1 on the board is switched.
Ai2-L	0 to 10 VDC / 0 to 20 mA switchable	SW2 on the board is switched.
Ai3-L	-10 to 10 VDC	-

- For each input, relation between the input signal and the frequency reference can be set independently.
- To add/subtract a command, the Sub speed command [AA102] and operator [AA105] should also be set. [Ai3] can be added to [Ai1] and [Ai2] without choosing an operator in the Terminal [Ai3] selection [Cb-22].
- For details, see “12.24.5 Analog Input Settings”

■ Parameters

Name	Code	Data	Description
Main speed input source selection, 1st-motor	[AA101]	01	Input between Ai1 and L enabled.
		02	Input between Ai2 and L enabled.
		03	Input between Ai3 and L enabled.
		04	Input between Ai4 and L enabled. *1)
		05	Input between Ai5 and L enabled. *1)
		06	Input between Ai6 and L enabled. *1)

*1) Optional P1-AG is necessary.



- The output of the inverter requires not only a frequency reference but also an operation command.
- Note that the voltage input and the current input are switched from each other by the terminal block dip switch.
- For adjustment of the analog input, see “12.24.5 Analog Input Settings”



- First, the voltage SW and current SW are switched when the wiring is made.

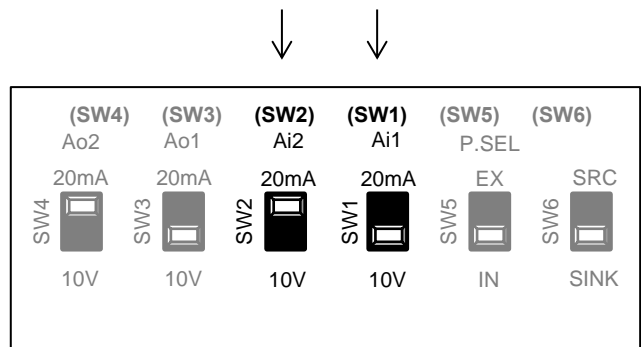

- Next, Main speed input source selection for the parameter [AA101] is set.

12.4.4 Command from RS485 Communication



- I want to input a frequency reference using S485 communication.



- For details, see “Chapter 14 RS485 Communication”.



- RS485 communication is used to give a frequency reference.

■ Parameters

Name	Code	Data	Description
Main speed input source selection, 1st-motor	[AA101]	08	Command from RS485 communication

12.4.5 Command from Optional Cassette



- I want to input a frequency reference using an optional cassette.



- For the frequency references, refer to the Basic / User’s Guide provided together with each optional cassette.
- Some User’s Guides are provided for electronic data only. For details, please contact your distributor or Hitachi Sales Office.



- Set which option cassette to input the frequency reference from multiple option cassettes.

■ Parameters

Name	Code	Data	Description
Main speed input source selection, 1st-motor	[AA101]	09	Frequency references from optional cassette in slot 1 enabled.
		10	Frequency references from optional cassette in slot 2 enabled.
		11	Frequency references from optional cassette in slot 3 enabled.

12.4.6 Making Command from Pulse Train Input

*To give a pulse train input frequency reference, there are two methods. One is to use the main body's terminals and the other is to use the optional P1-FB.

■ Input terminals [A] and [B] of the main body are used.

Q

- I want to set the frequency reference by the frequency of the pulse train input of the open collector.

A

- To use the input terminals [A] and [B] of the main body as a pulse train input frequency reference, set the [CA-90] to 01 (Frequency reference).
- The pulse train given as input to the input terminals [A] and [B] of the inverter is used.
- The pulse train given as input to the input terminals [A] and [B] can be used as frequency reference / PID feedback value in each control mode.
- Set the input pulse frequency that corresponds to the maximum frequency to the Pulse train frequency scale (Internal) [CA-92].
- The pulse train input values to the input terminals [A] and [B] can be monitored with [dA-70].

!

- Analog input adjustment function cannot be used. To limit the pulse train input frequency, use the Pulse train frequency bias value (Internal) [CA-94], the Pulse train upper frequency detection level (Internal) [CA-95], and the Pulse train lower frequency detection level (Internal) [CA-96].
- When the pulse input frequency is below the Pulse train frequency lower detection limit (Internal) [CA-96], it is regarded as 0 Hz in the processing.
- The start-up of the inverter may delay if the Pulse train lower frequency detection level (Internal) [CA-96] is set to a high value.

■ Parameters (main body)

Name	Code	Data range (unit)	Description
Main speed input source selection, 1st-motor	[AA101]	12	Frequency reference from pulse train input (input terminals [A] and [B])
Pulse train input, target function selection (Internal)	[CA-90]	01	Used for frequency reference
Pulse train input mode selection (Internal)	[CA-91]	00	Mode 0: 90 degrees shift pulse train
		01	Mode 1: Forward/Reverse pulse train and direction signal
		02	Mode 2: Forward pulse train and reverse pulse train
Pulse train frequency scale (Internal)	[CA-92]	0.05 to 32.00 (kHz)	Set the pulse train frequency that corresponds to the maximum frequency.
Pulse train frequency filter time constant (Internal)	[CA-93]	0.01 to 2.00 (sec)	A filter is applied to the input of the pulse train frequency.
Pulse train frequency bias value (Internal)	[CA-94]	-100.0 to 100.0(%)	A bias is applied to the input of the pulse train frequency.
Pulse train upper frequency detection level (Internal)	[CA-95]	0.0 to 100.0 (%)	Set the upper limit of the frequency reference for pulse train input.
Pulse train lower frequency detection level (Internal)	[CA-96]	0.0 to 100.0 (%)	Set the lower limit of the frequency reference for pulse train input. Below the lower limit will be 0.0%.

■ Monitor (main body)

Name	Code	Data range (unit)	Description
Pulse train input monitor (internal)	[dA-70]	-100.00 to 100.00(%)	The frequency reference from the pulse train input (input terminals A/B) is displayed.

- Internal arithmetic block diagram
Internal processing is schematically drawn.

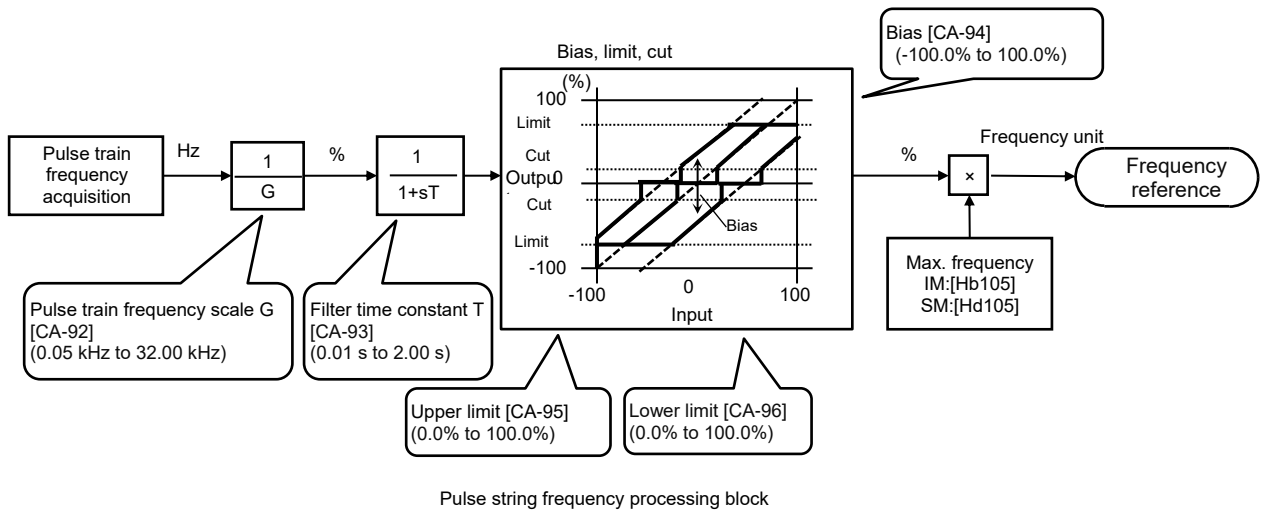

- For details of the pulse train input mode, see below.
The frequency reference is determined by the frequency of the pulse train input.
The sign of the frequency reference is determined in the following way.

(1) Mode 0: [CA-91]=00: 90 degrees shift pulse train

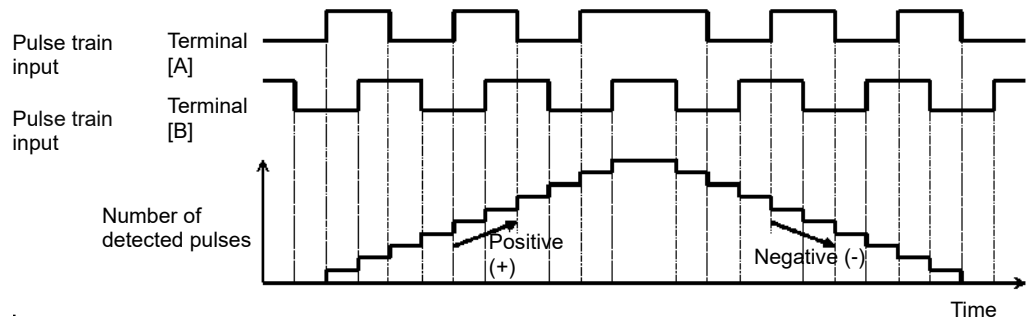

(2) Mode 1: [CA-91]=01: Forward/Reverse pulse train and direction signal

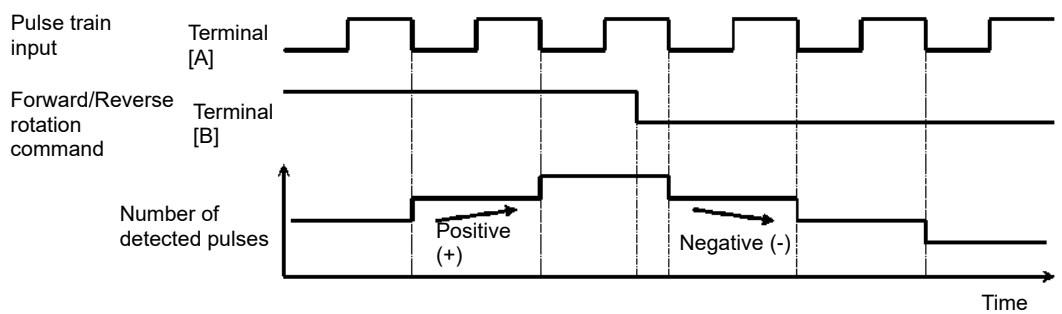

(3) Mode 2: [CA-91]=02: Forward pulse train and reverse pulse train

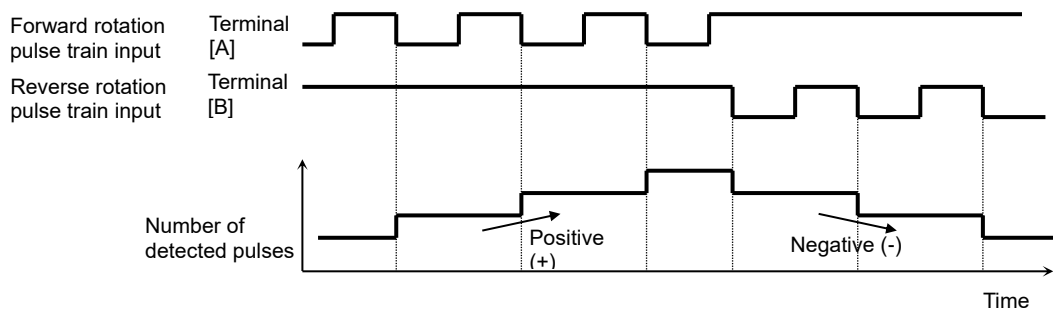

■ Use of optional cassette P1-FB



- I want to set the frequency reference by the frequency of the pulse train input of the line driver.



- The pulse train given in [SAP][SBP][SAN][SBN] of the optional cassette P1-FB (feedback option) is used.
- The pulse train given as input to P1-FB can be used as a frequency reference / PID feedback value in each control mode.
- Set the input pulse frequency that corresponds to the maximum frequency to the Pulse train frequency scale (option) [ob-12].
- The pulse train input values to P1-FB can be monitored with [dA-71].



- Analog input adjustment function cannot be used. To limit the pulse train input frequency, use the Pulse train frequency bias value (option) [ob-14], Pulse train upper frequency detection level(option) [ob-15], and the Pulse train lower frequency detection level (option) [ob-16]
- When the frequency of input pulse is below the Pulse train lower frequency detection level (option) [ob-16], it is regarded as 0 Hz in the processing.
- The start-up of the inverter may delay if the Pulse train lower frequency detection level (option) [ob-16] is set to a high value.

■ Parameters (option)

Name	Code	Data range (unit)	Description
Main speed input source selection, 1st-motor	[AA101]	13	Frequency reference from optional P1-FB enabled.
Pulse train input, target function selection (option)	[ob-10]	00	Used for frequency reference
Pulse train input mode selection (option)	[ob-11]	00	Mode 0: 90 degrees shift pulse train
		01	Mode 1: Forward/ Reverse pulse train and direction signal
		02	Mode 2: Forward pulse train and Reverse pulse train
Pulse train frequency scale (option)	[ob-12]	0.05 to 200.0 (kHz)	Set the pulse train frequency that corresponds to the maximum frequency.
Pulse train frequency filter time constant (option)	[ob-13]	0.01 to 2.00 (sec)	A filter is applied to the input of the pulse train frequency.
Pulse train frequency bias value (option)	[ob-14]	-100.0 to 100.0(%)	A bias is applied to the input of the pulse train frequency.
Pulse train upper frequency detection level(option)	[ob-15]	0.0 to 100.0 (%)	Set the upper limit of the frequency reference for pulse train input.
Pulse train lower frequency detection level (option)	[ob-16]	0.0 to 100.0 (%)	Set the lower limit of the frequency reference for pulse train input. Below the lower limit will be 0.0%.

■ Monitor (main body)

Name	Code	Data range (unit)	Description
Pulse train input monitor (option)	[dA-71]	-100.00 to 100.00(%)	The frequency reference from pulse train input (option input A phase / B phase)

Internal arithmetic block diagram
Internal processing is schematically drawn.

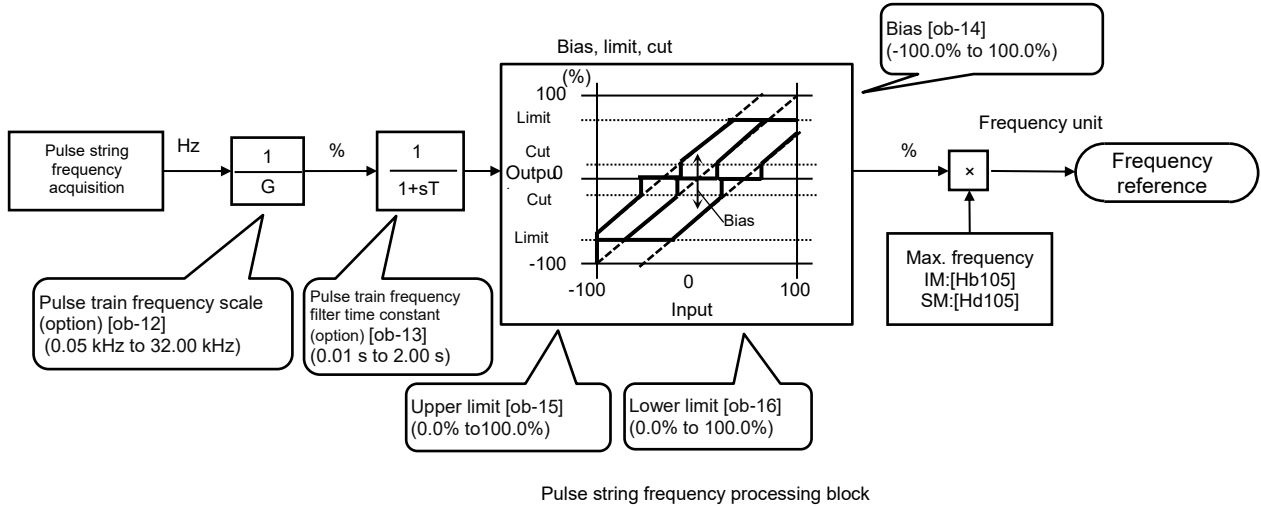

For details of the pulse train input mode, see below.
The frequency reference is determined by the frequency of the pulse train input.
The sign of the frequency reference is determined in the following way.

(1) Mode 0: [ob-11]=00: 90 degrees shift pulse train

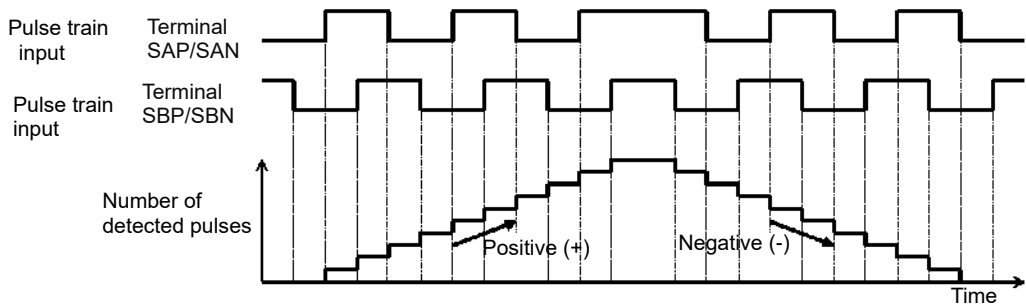

(2) Mode1:[ob-11]=01: Forward/ Reverse pulse train and direction signal

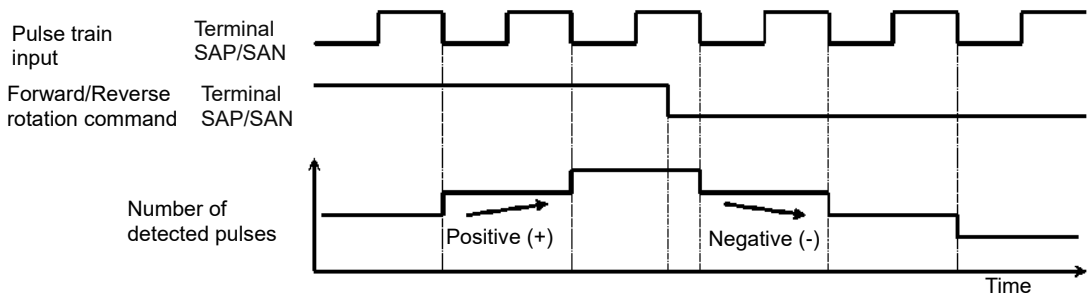

(3) Mode 2: [ob-11]=02: Forward pulse train and Reverse pulse train

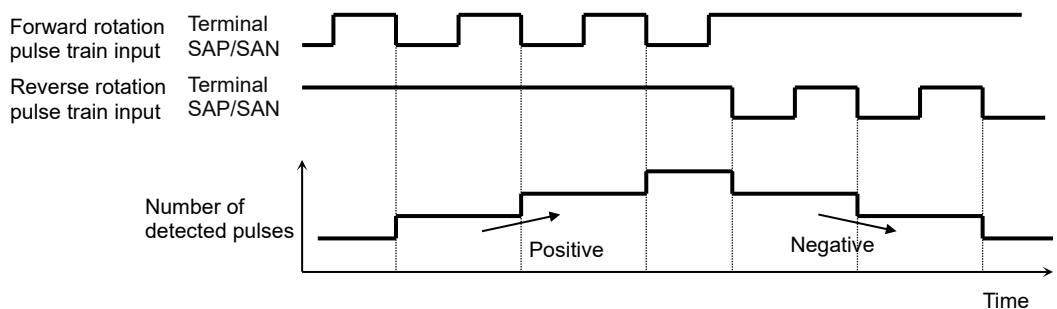

12.4.7 Command by Sequence Control (EzSQ)



- I want to set the frequency reference from the EzSQ function.



- If you want to set the frequency reference within the programming of EzSQ, it is possible by using the "Set-Freq" instruction.



- A program created on PC needs to be downloaded from the PC to the inverter.
- Downloaded program begins working when the program action of the EzSQ function is enabled.
- For details, see the "SJ series P1 Easy-Sequence Function(EzSQ) Programming Guide"(NT252*X).

■ Parameters

Name	Code	Data	Description
Main speed input source selection, 1st-motor	[AA101]	14	Frequency reference from the program function EzSQ enabled.
EzSQ enable setting	[UE-02]	00	Actions of the downloaded programs disabled.
		01	The program starts when [PRG] terminal is turned ON.
		02	The program starts after power supply is turned on.

12.4.8 Command by PID Control



- I want to use PID control to control a fan or pump.
- I want to use process control.



- To use the PID control for motor control, 15(PID calc.) is set in the speed input source selection after various settings of PID function.



- To give a command from the PID control, parameters of the PID control function need to be set. For details, see "12.10 Perform Process Control Suitable for the System Using PID Control"

■ Parameters

Name	Code	Data	Description
Main speed input source selection, 1st-motor	[AA101]	15	An arithmetic result of the PID control is output.

12.4.9 Selection or Calculation from Two Frequency References



- I want to multiply gain to the speed reference.
- I want to make a speed reference by adding two input values.
- I want to switch from forward to reverse rotation by subtracting the set value.
- I want to switch two speed reference.



- The followings can be selected depending on the setting the Speed reference calculation symbol selection [AA105]:
 - When [AA105] = 00, the Main speed selected in [AA101] and the Sub speed selected in [AA102] can be switched by 015 [SCHG] Main/Sub speed reference change input terminal function;
 - When [AA105] = 01 to 03, the frequency reference is the calculation result (addition / subtraction / multiplication) of the Main speed selected in [AA101] and the Sub speed selected in [AA102];

■ Parameters

Name	Code	Data	Description
Main speed input source selection, 1st-motor	[AA101]	01 to 16	00(Disable)/ 01(Terminal[Ai1])/ 02(Terminal[Ai2])/ 03(Terminal[Ai3])/ 04(Terminal[Ai4])/ 05(Terminal[Ai5])/ 06(Terminal[Ai6])/ 07(Parameter Setting)/ 08(RS485)/ 09(Option-1)/ 10(Option-2)/ 11(Option-3)/ 12(Pulse train input(internal))/ 13(Pulse train input(option))/ 14(Program function)/ 15(PID calc.)/ 16(MOP Keypad's VR)
Sub speed input source selection, 1st-motor	[AA102]	00 to 16	
Sub speed setting, 1st-motor	[AA104]	0.00 to 590.00(Hz)	Frequency setting of the sub speed on the operator keypad when [AA102] is set to 7.
Speed reference calculation symbol selection, 1st-motor	[AA105]	00	The calculation function is disabled and can be switched by main speed and sub speed using the [SCHG] terminal.
		01	(Main speed) + (Sub speed) is used for the command.
		02	(Main speed) - (Sub speed) is used for the command.
		03	(Main speed) x (Sub speed) is used for the command.
Input terminal function	[CA-01] to [CA-11]	015	[SCHG] switches between main and sub speed reference. This is effective when [AA105] is 00. OFF: Main speed is effective, ON: Sub speed is effective.

■ Calculation two commands

(Ex. 1) Gain is multiplied.

[AA101] = 01 (Ai1 command) / [AA102] = 07 (set [AA104]) /
 [AA105] = 03 (multiplication) / [AA104] = 3.00 (Hz)

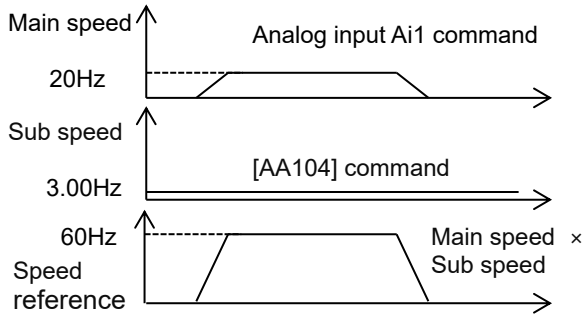

(Ex. 2) Speed reference by addition.

[AA101]=01 (Ai1 command) / [AA102]=02 (Ai2 command) /
 [AA105]=01 (addition)

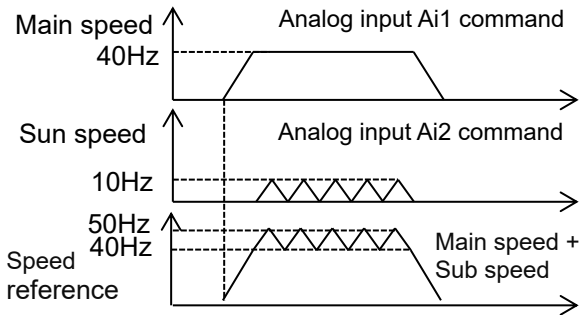

■ Switching of two speed reference

[AA101]=01 (Ai1 command) / [AA102]=07 (set [AA104]) /
 [AA105]=00 (disabled) / [AA104]=3.00(Hz)

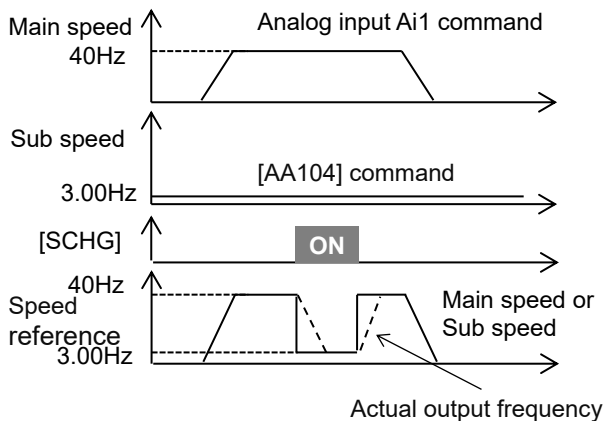

(Ex.3) Forward rotation at a high speed and reverse rotation at a low speed.

[AA101] = 01 (Ai1 command) / [AA102] = 07 (set [AA104]) /
 [AA105] = 02 (subtraction) / [AA104] = 10.00 (Hz)

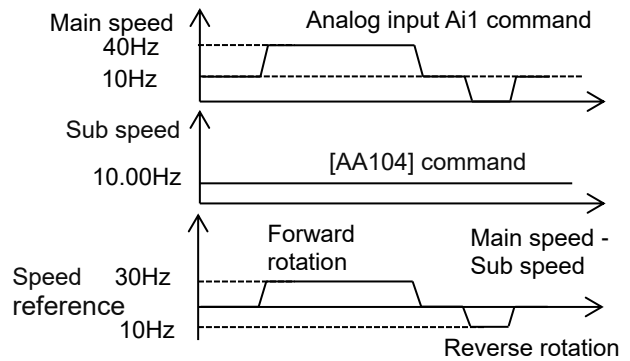

- The same setting can be used for both [AA101] and [AA102], Square calculation by multiplication is possible.
- The input terminal [FUP] / [FDN] functions are effective for commands where the main speed can be set (with the operator keypad setting, multi-speed setting, and analog input when the analog holding function [AHD] is ON).



- The output frequency of the inverter accelerates / decelerates toward the frequency reference, following the setting of the acceleration / deceleration time as indicated by the broken line in the figure.

12.4.10 Multi-Stage Switching of Frequency References



- I want to use signal input to make multi-stage switching of the output frequency of the inverter.



- A frequency reference is selected with a signal pattern by setting multiple frequency references in advance.
- In the multi-stage speed reference, one can either give a binary combination of 0 (OFF) and 1 (ON) or give a priority on certain terminals (bit operation).
- In the binary operation, a frequency at max. 16th speed with four terminals can be set. In the bit operation, a frequency at max. 8th speed with seven terminals can be set.



- If the operator keypad [AA101] = 07 is chosen in the frequency reference selection, rewriting of the main speed reference [FA-01] automatically rewrites [Ab110], frequency setting of the 0th speed.
- The frequency setting for the 1st to 15th speeds should be made in the 1st to 15th speeds of the multi-stage speed function ([Ab-11] to [Ab-25]).
- With the multi-stage speed function, one can set the acceleration/deceleration time individually for the frequency switching in the multi-stage speed reference. For details, see “12.8.3 Switching of Accel / Decel Time for Each Multi-Stage Speed Reference”.
- The multi-stage speed function is effective only for the main speed reference. Not applied to the Sub speed reference
- If [SET] terminal is made ON and the secondary setting function is used, [Ab210] instead of [Ab110] becomes effective.

■ Parameters

Name	Code	Data range (unit)	Description
Main speed reference setting or monitor	[FA-01]	Data change depending on the frequency reference selection.	The frequency reference value of the currently selected command source is displayed.
Multi-speed operation selection	[Ab-03]	00	Binary operation, max. 16 speed modes
		01	Bit operation, max. 8 speed modes
Multi-speed 0 setting, 1st-motor	[Ab110]	0.00 to max. frequency (Hz)	0th speed of the multi-stage speed
Multi-speed 1 to 15 setting	[Ab-11] to [Ab-25]	0.00 to max. frequency (Hz)	1st-15th speeds of the multi-stage speed
Multistage input determination time	[CA-55]	0 to 2000(ms)	This is the time to fix the frequency in switching the multi-stage speed.

■ (1) Binary operation (max. 16-speed command: [Ab-03]=00)

A

- Multi-stage speeds of 0th to 15th speeds can be chosen by assigning 003-006 ([CF1]-[CF4]) to the input terminal function [CA-01] to [CA-11].

■ Action table

Multi-stage speed	CF4	CF3	CF2	CF1	Parameters
0th speed	OFF	OFF	OFF	OFF	Ab110
1st speed	OFF	OFF	OFF	ON	Ab-11
2nd speed	OFF	OFF	ON	OFF	Ab-12
3rd speed	OFF	OFF	ON	ON	Ab-13
4th speed	OFF	ON	OFF	OFF	Ab-14
5th speed	OFF	ON	OFF	ON	Ab-15
6th speed	OFF	ON	ON	OFF	Ab-16
7th speed	OFF	ON	ON	ON	Ab-17
8th speed	ON	OFF	OFF	OFF	Ab-18
9th speed	ON	OFF	OFF	ON	Ab-19
10th speed	ON	OFF	ON	OFF	Ab-20
11th speed	ON	OFF	ON	ON	Ab-21
12th speed	ON	ON	OFF	OFF	Ab-22
13th speed	ON	ON	OFF	ON	Ab-23
14th speed	ON	ON	ON	OFF	Ab-24
15th speed	ON	ON	ON	ON	Ab-25

■ Action chart

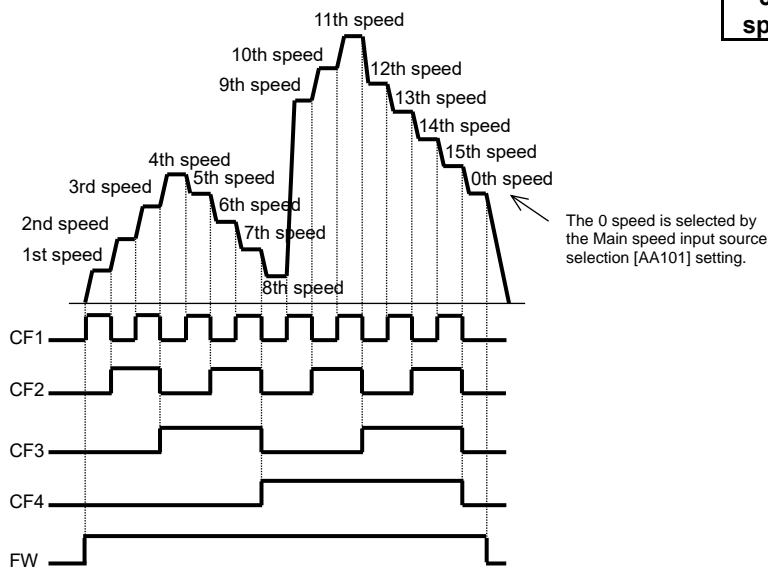

!

- For the binary operation, idling time to wait for a terminal input to be given can be set in the Multistage input determination time [CA-55]. This prevents the unintended state being selected during terminal switching.
- When there is no change in the input even after the set time of [CA-55], the data will be fixed. Note that the Input response would be slow if the determination time is set too long.
- For the frequency reference of the 0th speed, the command designated in the Main speed input source selection [AA101] is used. The left table is for [AA101]=07.

Ex.) 2nd speed is effective.

[CA-06]=003 (CF1) and [CA-07]=004 (CF2).

No assignment is made for 005 (CF3) and 006 (CF4).

Only the input terminal No. 7 (CF2) is ON.

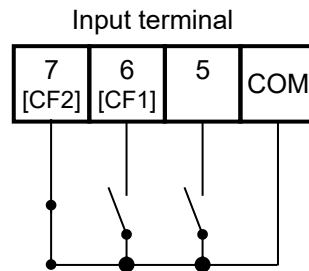

Multi-stage speed	CF4	CF3	CF2	CF1
1st speed	OFF	OFF	OFF	ON
2nd speed	OFF	OFF	ON	OFF
3rd speed	OFF	OFF	ON	ON

■ (2) Bit operation (max. 8-speed command: [Ab-03]=01)

A

- Multi-stage speeds of 0th to 7th speeds can be chosen by assigning 007 to 013 ([SF1] to [SF7]) to the input terminal function [CA-01] to [CA-11].
- The frequency setting of [SF1] to [SF7] should be made to the multi-stage speeds of 1st to 7th speeds ([Ab-11] to [Ab-17]).

!

- If multiple terminals are made ON simultaneously, the one with smaller number has priority. The terminals state of the "-" part in the table are not considered in the selection of frequency reference.
- For the command frequency of the 0th speed, the command designated in the Main speed input source selection [AA101] is used. The following table is for [AA101]=07.

■ Action table

Multi-stage speed	SF7	SF6	SF5	SF4	SF3	SF2	SF1	Parameters
0th speed	OFF	OFF	OFF	OFF	OFF	OFF	OFF	Ab110
1st speed	-	-	-	-	-	-	ON	Ab-11
2nd speed	-	-	-	-	-	ON	OFF	Ab-12
3rd speed	-	-	-	-	ON	OFF	OFF	Ab-13
4th speed	-	-	-	ON	OFF	OFF	OFF	Ab-14
5th speed	-	-	ON	OFF	OFF	OFF	OFF	Ab-15
6th speed	-	ON	OFF	OFF	OFF	OFF	OFF	Ab-16
7th speed	ON	OFF	OFF	OFF	OFF	OFF	OFF	Ab-17

■ Action chart

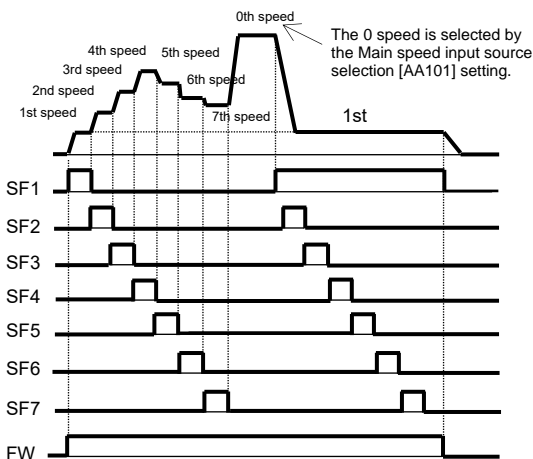

Ex.) 2nd speed is effective.

[CA-06]=007 (SF1) and [CA-07]=008 (SF2). No assignment is made for 009 (SF3) and 013 (SF7).

Only the input terminal No. 7 (SF2) is ON.

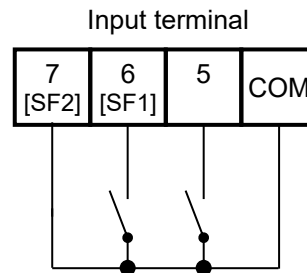

Multi-stage speed	SF4	SF3	SF2	SF1
1st speed	-	-	-	ON
2nd speed	-	-	ON	OFF
3rd speed	-	ON	OFF	OFF

If [SF1] becomes ON in this state, the 1st speed becomes effective.

12.4.11 Temporal Addition of Frequency Reference

Q

- I want to increase the frequency of the motor only if a signal input is given.
- I want to increase the frequency by giving a signal to the inverter with a conveyor or others.
- I want to remove clogging of the pump by increasing the frequency.

A

- Only when the input terminal function 014 [ADD] signal is given, the designated frequency is added or subtracted.
- Addition or subtraction is chosen on the basis of the designated sign of the frequency.



- The frequency addition of the input terminal function 014 [ADD] is made within the limited frequency range. If the frequency is not within the range between the upper and lower limits or exceeds the maximum frequency, the frequency reference is restricted.
- If the sign of the frequency reference changes ((-) to (+) or (+) to (-)) as a result of the arithmetic, the rotation direction is reversed.
- This function is also effective for PID target value.

■ Parameters

Name	Code	Data range (unit)	Description
Add frequency setting, 1st-motor	[AA106]	-590.00 to 590.00(Hz)	Sets the frequency to add.
Input terminal selection	[CA-01] to [CA-11]	014	[ADD] The designated frequency is added.

12.4.12 Remote Operation of Frequency

Q

- I want to change the motor frequency by using signal input.
- I want to change the frequency with an external remote button.
- I want to change the PID set-point value using the external remote button.

■ UP/DOWN function

A

- The frequency reference of the inverter can be changed by a signal input if 020 [FUP] terminal and 021 [FDN] terminal are assigned in the input terminal function.
- This function works following the selected frequency reference when the Main speed input source selection [AA101]/[AA201] is 07 (parameter effective) or when a multi-stage speed command is given.
Or, it operates for the frequency reference held by the 019 [AHD] function when the Main speed input source selection [AA101] / [AA201] setting is analog input 01 to 06.
- The command operation time with the terminals 020[FUP]/021[FDN] being ON follows the acceleration time [CA-64] to increase or the deceleration time [CA-66] to decrease.

!

- When 020 [FUP] terminal / 021 [FDN] terminal is made ON/OFF immediately after the power shutdown, the changed frequency reference may not be able to be correctly saved.
- Cannot be used to set the frequency of the input terminal function 029 [JG] jogging operation.

- Even when 024 [SET] function is used to switch to the second control, the operation time follows the acceleration time [CA-64] to increase or the deceleration time [CA-66] to decrease.
- If 01 (save) is chosen in [CA-61], the frequency value adjusted by the 020 [FUP] terminal / 021 [FDN] function can be saved at power supply shut down.
- By setting [CA-62] to 01 and turning ON the input terminal function [UDC], the stored value can be used as the frequency reference value.

■ Action chart

(In this case, the frequency reference is the parameter setting or multi-stage speed function)

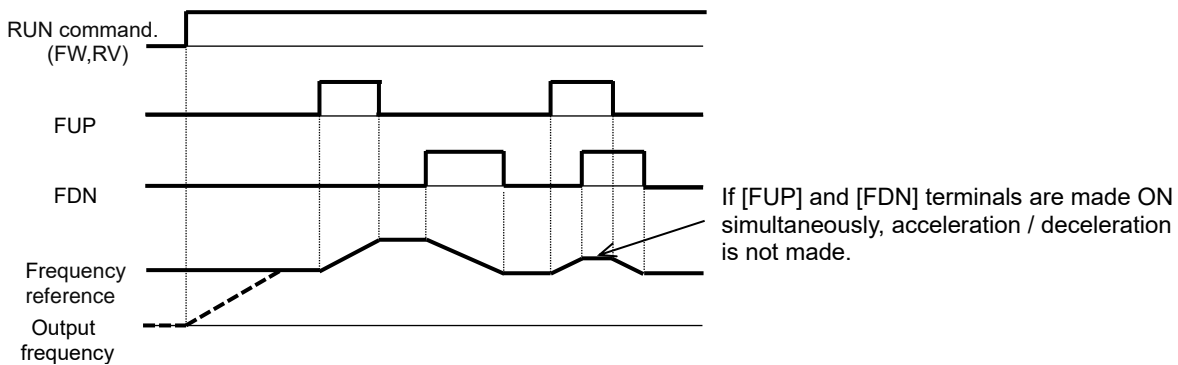

■ Analog command holding function



- The [FUP]/[FDN] function is valid even when the Main speed input source selection [AA101]/[AA201] setting is analog input (01 to 06) and the speed command is retained by the [AHD] analog command holding.



- The 019 [AHD] analog command holding function holds the command of the analog input when the function becomes ON. When the function becomes OFF, the command returns to the analog command. Namely, data changes with the [FUP]/[FDN] function are not saved.

■ Action chart

(A frequency reference uses [AHD] in the analog input.)

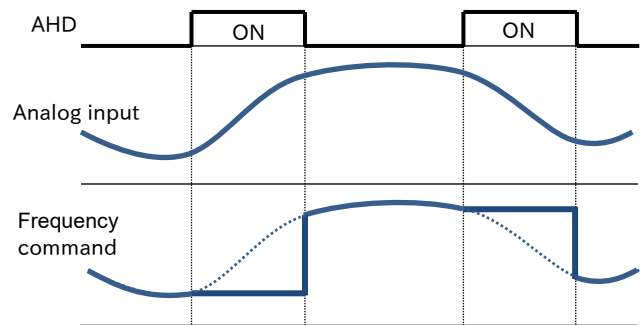

■ Parameters

Name	Code	Data range (unit)	Description
Main speed input source selection, 1st-motor	[AA101]	01 to 16	00(Disable)/ 01(Terminal[Ai1])/ 02(Terminal[Ai2])/ 03(Terminal[Ai3])/ 04(Terminal[Ai4])/ 05(Terminal[Ai5])/ 06(Terminal[Ai6])/ 07(Parameter Setting)/ 08(RS485)/ 09(Option-1)/ 10(Option-2)/ 11(Option-3)/ 12(Pulse train input(internal))/ 13(Pulse train input(option))/ 14(Program function)/ 15(PID calc.)/ 16(MOP Keypad's VR)
Sub speed input source selection, 1st-motor	[AA201]	00 to 16	
Input terminal function	[CA-01] to [CA-11]	019	AHD:analog command holding
		020	FUP: Remote control Speed-UP function
		021	FDN: Remote control Speed-DOWN function
		022	UDC: Remote control Speed data clearing
FUP/FDN overwrite target selection	[CA-60]	00	Overwrites the frequency reference.
		01	PID1 set-point 1 (including PID1 multistage set-point) are overwritten.
FUP/FDN data save enable	[CA-61]	00	The frequency reference is not saved in case of power shutdown.
		01	The frequency reference is saved in case of power shutdown.
FUP/FDN UDC selection	[CA-62]	00	Cleared to 0 Hz.
		01	Cleared to the saved command.
Acceleration time setting for FUP/FDN function	[CA-64]	0.00 to 3600.00(s)	Sets acceleration time for FUP/FDN functions.
Deceleration time setting for FUP/FDN function	[CA-66]	0.00 to 3600.00(s)	Sets deceleration time for FUP/FDN functions.

12.4.13 Temporary Change the Frequency Reference Input Source



- I want to temporarily change the frequency reference input source to analog input.
- I want to make temporary operation with fixed frequency reference.



- When the 023 [F-OP] Force operation function is on, the frequency reference input source selected in [CA-70] has priority over others, except for jogging operation.



- When the 023 [F-OP] forced operation function is ON, the RUN command input source is also selected by [CA-71]. See also “12.5.8 Temporary Change the RUN Command Input Source”
- The 029[JG] Jogging has higher priority than the 023[F-OP] forced operation. For details, refer to the figure in “12.4.1 Type of Frequency Reference”.

■ Parameters

Name	Code	Data range	Description
Input terminal function	[CA-01] to [CA-11]	023	[F-OP]: Force operation
Speed reference source selection when [F-OP] is active	[CA-70]	01 to 16	01(Terminal[Ai1])/ 02(Terminal[Ai2])/ 03(Terminal[Ai3])/ 04(Terminal[Ai4])/ 05(Terminal[Ai5])/ 06(Terminal[Ai6])/ 07(Parameter Setting)/ 08(RS485)/ 09(Option-1)/ 10(Option-2)/ 11(Option-3)/ 12(Pulse train input(internal))/ 13(Pulse train input(option))/ 14(Program function)/ 15(PID calc.)/ 16(MOP Keypad's VR)
RUN command source selection when [F-OP] is active	[CA-71]	00 to 06	00([FW]/[RV] terminal)/ 01(3-wire)/ 02(Keypad's RUN-key)/ 03(RS485)/ 04(Option-1)/ 05(Option-2)/ 06(Option-3)

12.5 Selection of RUN Command

12.5.1 Types of RUN Command



- The RUN command (operation modes) selected in each function is enabled.
- For details, see the next and subsequent sections.



- The operation of the inverter requires not only a RUN command but also a frequency reference.

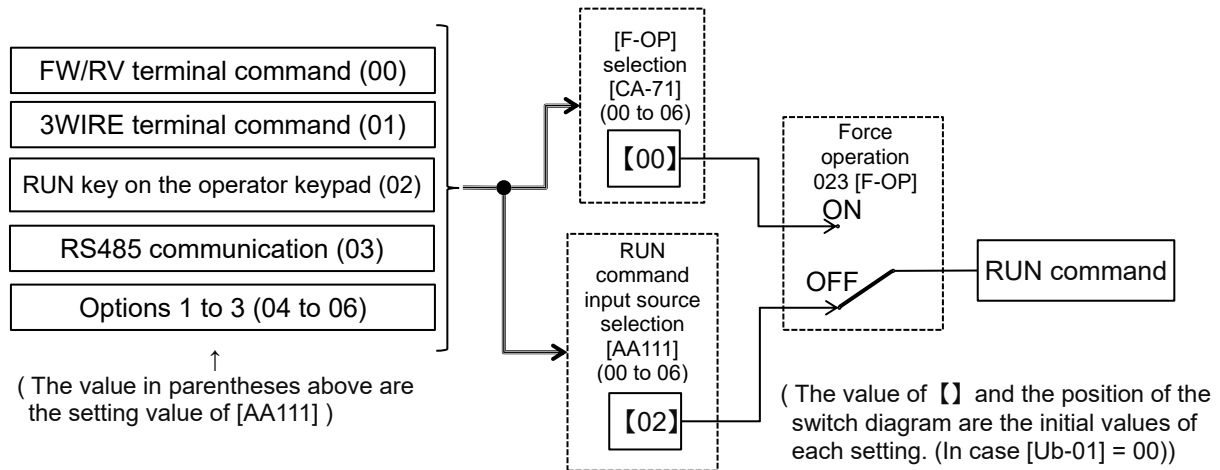

- The above shows an example of operation with [AA111]=02 (RUN key on the operator keypad).
- Functions not assigned to the input terminal functions [CA-01] to [CA-11] become OFF.

12.5.2 Operation on Operator Keypad

Q

- Want to make trial operation from the operator keypad.
- Want to make operation from the operator keypad.

A

- The operator keypad is used to give a RUN command.
- Use “RUN key” and “STOP key” to make and stop operation, respectively.
- For operation using the operator keypad, the operation direction can be changed by setting the RUN-key command rotation direction [AA-12].



- The output of the inverter requires not only a RUN command but also a frequency reference.
- If the forced operation 023 [F-OP] of the terminal function is enabled, the command destination specified in the [F-OP] function becomes effective irrespective of the present setting.

Parameters

Name	Code	Data	Description
RUN command input source selection, 1st-motor	[AA111]	02	RUN command from “Run key”/“Stop key” on the keypad.
RUN-key command rotation direction	[AA-12]	00	Forward rotation command from the operator keypad.
		01	Reverse rotation command from the operator keypad.
Output terminal function	[CC-01] to [CC-07]	011	[REF] turns ON if the RUN command can be input from the operation keypad.

12.5.3 Operation Using Forward / Reverse Input Terminal Function



- Want to make operation with input to the terminal of the inverter.
- Want to switch forward and reverse rotation by making the terminal ON/OFF.



- A forward rotation command can be given from [FW] terminal and a reverse one from [RV] terminal.
- Operation can be started/stopped by making the [FW] or [RV] terminal function ON/OFF on the control circuit terminal block of the inverter.
- In the factory setting, the [FW] and [RV] terminals are assigned to the terminal Nos. 9 and 8, respectively. This assignment can be changed by setting [CA-01] to [CA-11] in the input terminal setting selection.
- a/b(NO/NC) contact of each terminal can be switched by changing the corresponding setting item of [CA-21] to [CA-31].



- The output of the inverter requires not only a RUN command but also a frequency reference.
- If the input terminal function 023 [F-OP] is enabled, the command destination specified in the [F-OP] function becomes effective irrespective of the present setting.

- Simultaneous input of a forward and reverse rotation commands is equivalent to stop command.
- The relation between [FW] and [RV] terminals is given below.

FW terminal	RV terminal	RUN command
OFF	OFF	Stop command
ON	OFF	Forward rotation command.
OFF	ON	Reverse rotation command.
ON	ON	Stop command

- Commands can be given by [FW]/[RV] command of the EzSQ function.

■ Parameters.

Name	Code	Data	Description
RUN command input source selection, 1st-motor	[AA111]	00	Run/Stop from the control circuit terminal block. ([FW], [RV] terminals)
Input terminal function	[CA-01] to [CA-11]	001	[FW] input terminal function
		002	[RV] input terminal function
Input terminal active state	[CA-21] to [CA-31]	00	a contact (NO)
		01	b contact (NC)

12.5.4 Operation Using 3-Wire Input Terminal Function

Q

- Want to make operation with input to the terminal of the inverter.
- Want to make operation with button switch.
- Want to reduce the external self-holding circuit of the operation button.

A

- Operation start command can be given from [STA] terminal and stop command from [STP] terminal.
- To use the 3 wire function, the setting of the RUN command input source selection [AA111] and the input terminal setting selection [CA-01] to [CA-11] needs to be changed.
- Select [AA111]=01,3 wire function. In this example, the 3 wire function is assigned to the input terminal function in the following way.
 *) Set the terminals as the terminal No. 7 [CA-07]=016, No. 8 [CA-08]=017, No. 9 [CA-09]=018.

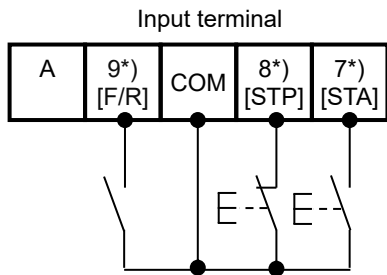

!

- The output of the inverter requires not only a RUN command but also a frequency reference.
- The forced operation 023 [F-OP] is enabled, the command destination specified in the [F-OP] function becomes effective irrespective of the present setting.
- Operation can be started/stopped by making the 016 [STA]/017 [STP] terminal function ON/OFF on the control circuit terminal block of the inverter.
- When the input terminal 016[STA] is turned on while the input terminal 017[STP] is on, operation starts.
- If the input terminal 017[STP] is turned off from the operating status, the motor will decelerate to a stop. To restart, turn on the input terminal 017[STP] again and turn on the input [STA] terminal.
- The rotation direction is selected with the input terminal 018[F/R] terminal.

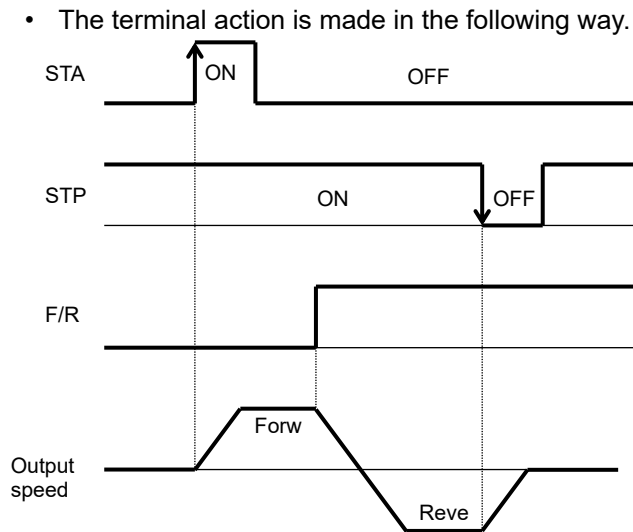

■ Parameters

Name	Code	Data	Description
RUN command input source selection, 1st-motor	[AA111]	01	Run/Stop from the control circuit terminal block. ([STA], [STP] terminals)
Input terminal function	[CA-01] to [CA-11]	016	[STA] input terminal function
		017	[STP] input terminal function
		018	[F/R] input terminal function

12.5.5 Operation with RS485 Communication



- I want to make RUN / STOP operation with a command through RS485 communication.



- RS485 MODBUS communication is used to give an operation start/stop command.



- The output of the inverter requires not only a RUN command but also a frequency reference.
- The forced operation 023 [F-OP] is enabled, the command destination specified in the [F-OP] function becomes effective irrespective of the present setting.

Parameter.

Name	Code	Data	Description
RUN command input source selection, 1st-motor	[AA111]	03	Start/Stop by RS485 communication command.

12.5.6 Operation from Optional Cassette



- I want to make RUN / STOP operation with a command through communication of the optional cassette.



- Optional communication command is used to give an operation start/stop command.



- The output of the inverter requires not only a RUN command but also a frequency reference.
- The forced operation 023 [F-OP] is enabled, the command destination specified in the [F-OP] function becomes effective irrespective of the present setting.

Parameter.

Name	Code	Data	Description
RUN command input source selection, 1st-motor	[AA111]	04	Frequency command from option 1 enabled.
		05	Frequency command from option 2 enabled.
		06	Frequency command from option 3 enabled.

12.5.7 Disabling the Keys on Operator Keypad

Q

- I don't want to enable the keypad's stop when the RUN command other than keypad is valid.
- I don't want to enable the keypad's stop when the inverter is in running via RS485 communication, however want to valid the trip reset from keypad.

A

- When a terminal command or communication command is given, the operation can be disabled from the operator keypad by setting [AA-13]=00 or 02.
- Set [AA-13]=02 to disable the Stop key and use the resetting function in case of a trip.
- When 102 [DISP] input terminal function is ON, the operator keypad screen is fixed to home screen.

!

- Set [AA-13] to 01: enabled if a stop command is given from the operator keypad of the inverter in case of emergency.
- Usually, operation under the RUN command from other than the operator keypad can be stopped by using the Stop/Reset key on the operator keypad.
- When the operation under an external command is stopped from the operator keypad, the operation stops for safety. To restart the operation, turn off the external command and on it again.
- The selection of the STOP-key enable [AA-13] is valid when the RUN command input source selection [AA111] is set to other than 02(Keypad's RUN-key).

Parameter.

Name	Code	Data	Description
RUN command input source selection, 1st-motor	[AA111]	00	Run/Stop from the control circuit terminal block. ([FW], [RV] terminals)
		01	Run/Stop from the control circuit terminal block. ([STA], [STP] terminals)
		02	Run/Stop from Operator Keypad.
		03	Run/Stop by RS485 communication command.
		04	Run/Stop from optional cassette 1
		05	Run/Stop from optional cassette 2
		06	Run/Stop from optional cassette 3
STOP-key enable	[AA-13]	00	Function disabled. Always recognizes stop/reset key operation.
		01	Function enabled. The stop/reset key no longer works.
		02	Only inverter trips can be reset by the stop/reset key.
Input terminal function selection	[CA-01] to [CA-11]	102	[DISP] terminal function

12.5.8 Temporary Change the RUN Command Input Source



- I want to make RUN / STOP command from the operator keypad temporarily.
- I want to make RUN / STOP command from the input terminal block temporarily.



- When the 023 [F-OP] Force operation function is ON, the RUN command input source selected in [CA-71] has priority over others.



- When the 023 [F-OP] Force operation function is ON, the frequency reference input source is also selected by [CA-70]. See also “12.4.13 Temporary Change the Frequency Reference Input Source”.
- If [AA111] and [CA-71] are set differently from each other, when the [F-OP] terminal is turned ON or OFF while the inverter is in running, the inverter will be stopped. In this case, once the selected RUN command is turned off and then turned on again, the inverter will restart running.

Parameter.

Name	Code	Data	Description
Input terminal function	[CA-01] to [CA-11]	023	[F-OP]: Force operation
Speed reference source selection when [F-OP] is active	[CA-70]	01 to 16	01(Terminal[Ai1])/ 02(Terminal[Ai2])/ 03(Terminal[Ai3])/ 04(Terminal[Ai4])/ 05(Terminal[Ai5])/ 06(Terminal[Ai6])/ 07(Parameter Setting)/ 08(RS485)/ 09(Option-1)/ 10(Option-2)/ 11(Option-3)/ 12(Pulse train input(internal))/ 13(Pulse train input(option))/ 14(Program function)/ 15(PID calc.)/ 16(MOP Keypad's VR)
RUN command source selection when [F-OP] is active	[CA-71]	00 to 06	00([FW]/[RV] terminal)/ 01(3-wire)/ 02(Keypad's RUN-key)/ 03(RS485)/ 04(Option-1)/ 05(Option-2)/ 06(Option-3)

12.6 Limits to Frequency Reference and RUN Command

12.6.1 Limit Frequency References

Q

- I want to limit the frequency reference range.
- I want to set the lower limit of the frequency reference value to prevent excessively low flow rate.
- I want to set the upper limit of the frequency reference value for the system.

A

- The upper and lower limits of the frequency reference can be set. In addition, the input source of the upper limit value can be set by setting [bA101]. For example, the upper limit can be specified from the analog input.
- This function limits a frequency command even if a frequency command value outside the range between the upper and lower limiters is set.



- To enable the Upper frequency limit, sets the [bA101] to a value other than 00 (Disable).
- When the Upper frequency limit source selection [bA101] = 07 (Parameter Setting), be sure to set the Upper frequency limit [bA102]. Note that this function operates even in the initial setting 0.00 Hz, and the inverter output frequency at starts will be limited 0.00 Hz.
- The Upper and Lower frequency limit settings should be set lower than the Max. frequency. Otherwise, the inconsistency warning is occurred.
- First, set the Upper frequency limit [bA102], and then make sure that the Upper frequency limit [bA102] setting is larger than the Lower frequency limit [bA103] setting.
- The LIM icon is displayed on the operator keypad when the output frequency is limited by the upper, lower, and minimum frequency limit settings.

Parameters

Name	Code	Data range (unit)	Description
Async. Motor maximum frequency setting, 1st-motor / Sync. Motor Maximum frequency setting, 1st-motor	[Hb105] / [Hd105]	10.00 ([Hb104]/[Hd104]) to 590.00 (Hz)	Sets the max. frequency. IM: Induction motor [AA121]=00 to 10 SM(PMM): Synchronous motor (permanent magnet motor) [AA121]=11, 12
Minimum frequency adjustment, 1st-motor	[Hb130]	0.00 to 10.00 (Hz)	Sets the min. frequency to start output. Disabled when [AA121]=09, 10.
Upper frequency limit source selection, 1st-motor	[bA101]	00 to 13	00(Disable)/ 01(Terminal[Ai1])/ 02(Terminal[Ai2])/ 03(Terminal[Ai3])/ 04(Terminal[Ai4])/ 05(Terminal[Ai5])/ 06(Terminal[Ai6])/ 07(Parameter Setting)/ 08(RS485)/ 09(Option-1)/ 10(Option-2)/ 11(Option-3)/ 12(Pulse train input(internal))/ 13(Pulse train input(option))
Upper frequency limit, 1st-motor	[bA102]	[bA103] to Max. frequency (Hz)	Sets the upper limit of the frequency command.
Lower frequency limit, 1st-motor	[bA103]	0.00 to [bA102] (Hz)	Sets the lower limit of the frequency command.
Frequency upper limit monitor	[dA-14]	0.00 to 590.00(Hz)	The employed upper limit of the frequency is shown.

Limiting a command

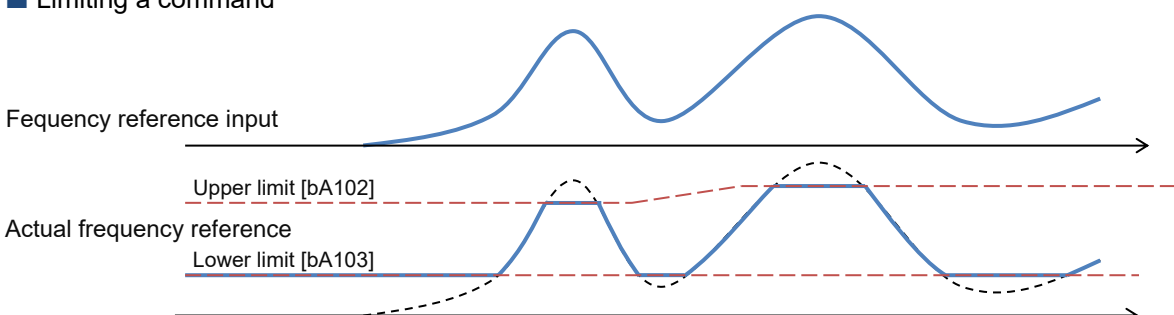

12.6.2 Limit RUN Commands Direction

Q

- I want to limit the RUN command direction.
- I want to prevent damage of the machine due to the inverter output in opposite direction.

A

- Output in the allowed rotation direction can be obtained by setting the RUN direction restriction [AA114] to limit the direction of the operation.
- Set the RUN direction restriction if reverse operation output could adversely affect connected machines with no external force applied.
- If [AA114] is set to 01 (valid only for forward rotation), reverse rotation due to negative frequency command will also be limited.
- While the direction is limited, the output from the inverter to the motor is shut off.

!

- Even if the RUN command direction restriction by this function works, the inverter may output reverse rotation depending on the control result in cases other than V/f control.
In this case, enable the [HC114] Direction reversal protection function.
See “12.6.3 Limit the Rotation Output Direction of the Inverter.”
- Even if this function is used, the motor may rotate in the reverse direction under an external force applied in that direction. In such case, Please configure the system that limits the rotation direction by not receiving an external force in the opposite direction.

Parameters

Name	Code	Data	Description
RUN direction restriction, 1st-motor	[AA114]	00	Both forward and reverse rotations enabled
		01	Only forward rotation enabled
		02	Only reverse rotation enabled

12.6.3 Limit the Rotation Output Direction of the Inverter.



- I want to prevent damage of the machine due to reverse rotation of the motor.



- Depending on the control method, the inverter may output rotation in the direction opposite to the run command direction at low speeds. The output can be restricted in the direction specified by the RUN command by using the Direction reversal protection [HC114] is used.
- Enable this function if the reverse rotation of the motor could give damage to the connected machine.



- This function is enabled when the control method [AA121] is set to 08 (Sensorless vector control (IM)), 09 (Zero-Hz-range sensorless vector control (IM)), or 10 (Vector control with encoder (IM)).
- Even if this function is used, the motor may rotate in the reverse direction under a high-load external force applied in that direction. When using this function, Please make a sufficient confirmation that the motor does not rotate in the reverse direction.

Name	Code	Data	Description
Control mode selection, 1st-motor	[AA121]	08	Sensorless vector control (IM)
		09	Zero-Hz-range sensorless vector control (IM)
		10	Vector control with encoder (IM)
Direction reversal protection, 1st-motor	[HC114]	00	Disabled
		01	Enabled

12.6.4 Disable Output Until RUN Command Permission

Q

- I want to prohibit output from the inverter to the motor until the system allows the RUN command.

A

- In consideration of the safety of the system configuration, it is possible to prevent the inverter to be running until the system gives permission, regardless of the status of the RUN command.
- If 101[REN] is assigned in the input terminal function, the inverter cannot output to the motor until the terminal 101[REN] becomes ON.



- This function becomes enabled when 101[REN] is set to any of the input terminal function [CA-01] to [CA-11].
- The operation does not start if 101[REN] is set to OFF. When the inverter is temporarily operated for test run, etc., 101[REN] must be temporarily set to 000[no].

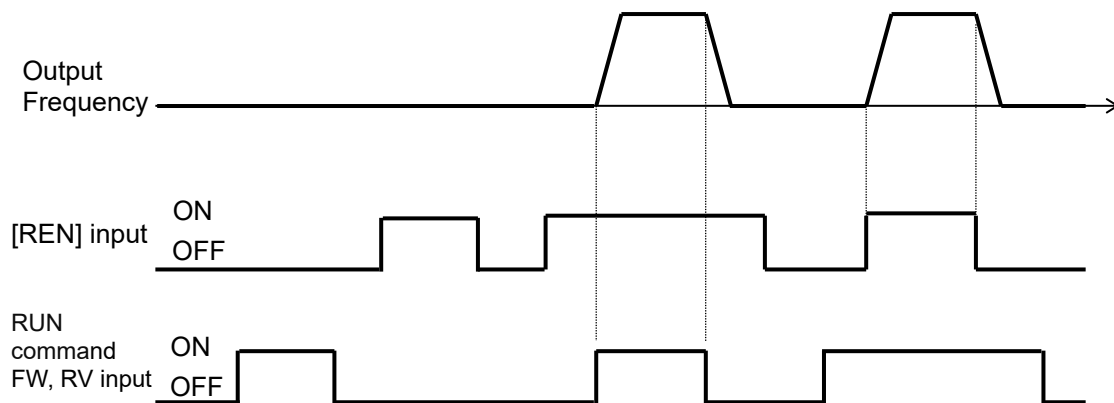

Parameters

Name	Code	Data	Description
Input terminal function	[CA-01] to [CA-11]	101	[REN]: RUN command enabled / Not enabled ON: Enabled OFF: Not enabled

12.7 Temperature Protection of Motor

12.7.1 Electronic Thermal Settings of Motor

Q

- I want to make thermal protection of motor.
- I want to change the protection level in accordance with the motor rated current.

Change of electronic thermal level of motor.

A

- By setting according to the motor rated current, the electronic thermal protection is applied if current exceeding the rated current continues to flow to the motor. To make the protection earlier, the Electronic thermal level setting [bC110] should be set lower than the motor rated current.

(Ex. 1) The motor rated current is 64 A.

Conditions:

[bC110] = 64.0 A;

[bC111] = 00 or 01;

When driving at the base frequency;

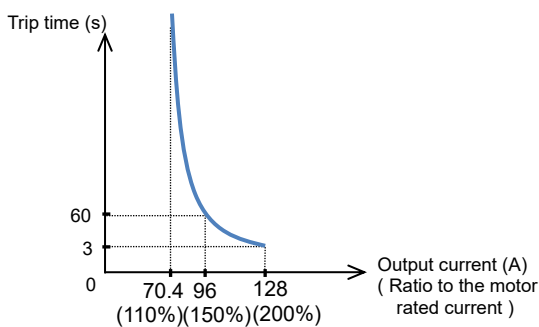

Parameters.

Name	Code	Data range (unit)	Description
Electronic thermal level setting, 1st-motor	[bC110]	0.0 to 3.0 times the rated current of the inverter (unit: A) *1)	Sets the protection current of motor.
Electronic thermal characteristic selection, 1st-motor	[bC111]	00	Reduced torque characteristics: This pattern corresponds to the deterioration of the motor's cooling capacity in the low speed range.
		01	Constant torque characteristics: This pattern corresponds to constant torque output.
		02	Free setting: The pattern can be freely set the electronic thermal characteristics according to the characteristics of the motor.

*1) The inverter rated current is switched by the load type selection [Ub-03]. Even if [bC110] is set to be high, [E001] Overcurrent error occurs when the output current exceeds the over current level.

!

- Make the setting correctly as this is necessary to protect the motor.
- When the thermal protection occurs, the [E005] Motor overload error occurs.
- When the current grows rapidly, the [E001] Overcurrent error could occur before the [E005] Motor overload error.
- In SJ-P1, the electronic thermal protection of the inverter and the electronic thermal protection of the motor are implemented separately. Therefore, even if large value is set to [bC110], the inverter overload protection error [E039] may occurred before [E005]. Also, note that the electronic thermal characteristics of the inverter are fixed for each model and cannot be changed by user parameters.
- See below for details on the electronic thermal of the inverter:
 - "12.19.9 Outputting a Warning Before Thermal Protection of the Inverter";
 - "13.13.2 Checking the Load Factor of the Thermal Load Rating (Inverter)";
 - "E039 Controller (inverter) overload error" in Chapter 18;

A

- The electronic thermal time-limited characteristics is shown in (Ex. 1) when the [bC110] is 64 A, the [bC111] is 00 or 01 and the inverter is driven at the base frequency (It means reduction rate is x1).
- If current of 150% of the Electronic thermal level setting [bC110] continues to flow, [E005] Motor overload error occurs after 60 sec.
- Depending on the Electronic thermal characteristic selection [bC111], the reduction rate characteristic is changed and the time until the trip occurs is changed too. For details, see the next section.

Change of electronic thermal characteristics.

Q

- I want to perform protection considering the cooling ability of the motor at low speed.
- I want to change the thermal protection setting pattern freely.

A

- Optimal protection characteristics can be obtained in consideration of the reduction of motor cooling capacity at low speed. ([bC111]=00)
- By the free setting of electronic thermal characteristics selection, the thermal characteristics depending on the frequency can be set. ([bC111]=02)

!

- Self-cooling motor needs to be used with reduced load (current) since the cooling function of the self-cooling fan becomes less effective when the motor rotation frequency decreases.
- The reduced torque characteristics is in accordance with the heat generation of the self-cooling motor.

Parameters.

Name	Code	Data range (unit)	Description
Electronic thermal characteristic selection, 1st-motor	[bC111]	00	Reduced torque characteristics: This pattern corresponds to the deterioration of the motor's cooling capacity in the low speed range.
		01	Constant torque characteristics: This pattern corresponds to constant torque output.
		02	Free setting: The pattern can be freely set the electronic thermal characteristics according to the characteristics of the motor.

Reduced torque electronic thermal [bC111]=00.

(Ex. 2) Induction motor rated current 64A,

Conditions:

- [bC110] = 64.0 A; [bC111] = 00;
- Base frequency [Hb104] = 60 Hz;
- Output frequency = 20 Hz;
- (As shown in the figure below, at 20 Hz, the reduction rate is 80%.)

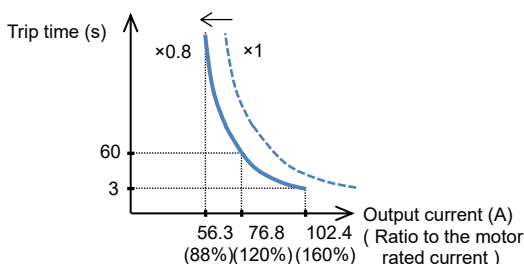
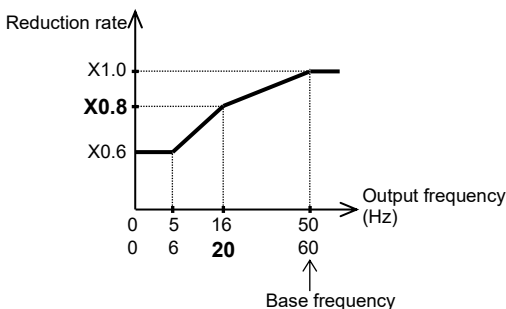

A

- It can be used in applications which it is necessary to reduce the load current according to the cooling capacity of the motor at low speed.
- When the electronic thermal level [bC110] is 64 A and the output frequency is 20 Hz and the base frequency is 60 Hz, the reduction rate is 80% and the electronic thermal characteristics are as shown in the lower left diagram of Example 2.
- Since Example 1 shows the case of the reduction rate =100%, so the [E005] trip occurs after 60 sec when the electric current of 150% ×1 of the motor rated current flows continuously. In case Example 2, the [E005] trip occurs after 60 sec when the electric current of 150%×0.8=120% of the motor rated current flows continuously.

- Constant torque electronic thermal.
 - Use this setting to use the constant-torque motor

(Ex. 3) Induction motor rated current: 64A,
 [bC110]=64(A),
 Base frequency [Hb104]=50Hz,
 Output frequency =5Hz

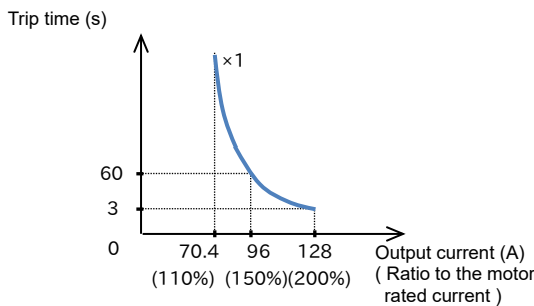
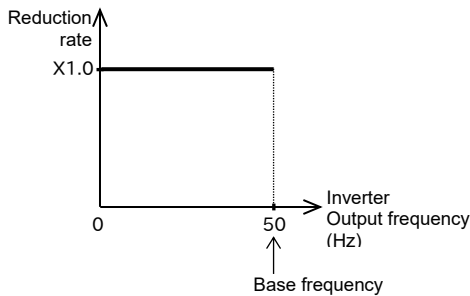

- When the electronic thermal level [bC110] is 64A and the output frequency is 5Hz to 50Hz with the base frequency of 50Hz, the reduction rate is $\times 1.0$, and the electronic thermal characteristics is shown in the lower figure of Example 3.
- Since the reduction rate is $\times 1.0$ same as Example 1, the [E005] trip occurs 60 seconds after 150% $\times 1$ of current flows continuously.



- For protect the inverter, thermal characteristic in the low speed range below 5 Hz is reduced (80% at 0 Hz) with the electronic thermal protection of the inverter. Therefore, the inverter overload protection error [E039] may occurred in the low speed range.
- When using a self-cooling motor that reduces motor cooling capacity at low speeds, take care of the heat generated by the motor. Use the reduced torque characteristics or free setting in the electronic thermal characteristic selection [bC110] depending on the heat generation characteristics of the motor.

- Free electronic thermal characteristics.
 - To protect the motor, the electronic thermal characteristics can be freely set in accordance with the load.

■ Parameters.

Name	Code	Data range (unit)	Description
Free electronic thermal frequency-1, 1st-motor	[bC120]	0.00 to [bC122] (Hz)	Frequency corresponding to free electronic thermal current 1
Free electronic thermal current-1, 1st-motor	[bC121]	(0.0 to 3.0) x Inverter rated current (A) *1)	Current corresponding to free electronic thermal frequency 1
Free electronic thermal frequency-2, 1st-motor	[bC122]	[bC120] to [bC124](Hz)	Frequency corresponding to free electronic thermal current 2
Free electronic thermal current-2, 1st-motor	[bC123]	(0.0 to 3.0) x Inverter rated current (A) *1)	Current corresponding to free electronic thermal frequency 2
Free electronic thermal frequency-3, 1st-motor	[bC124]	[bC122] to 590.00(Hz)	Frequency corresponding to free electronic thermal current 3
Free electronic thermal current-3, 1st-motor	[bC125]	(0.0 to 3.0) x Inverter rated current (A) *1)	Current corresponding to free electronic thermal frequency 3

*1) The inverter rated current is switched by the load type selection [Ub-03].

Free electronic thermal characteristics (continued).
(Ex. 4) For output frequency = [bC122]

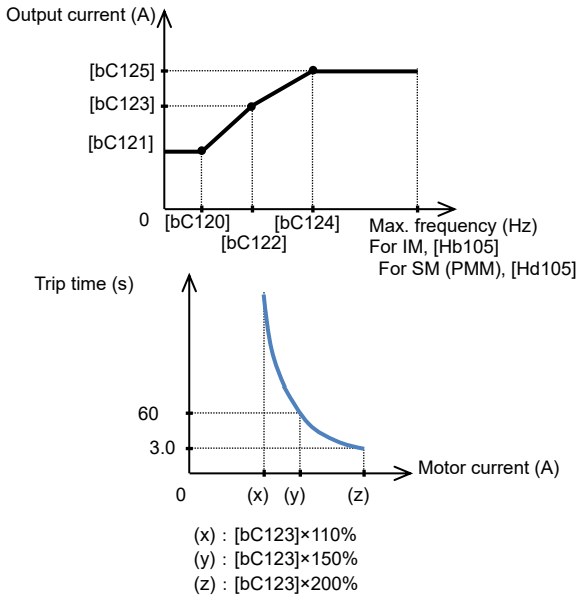

Change the heat dissipation characteristics of electronic thermal.



I want to set heat dissipation characteristics of the motor appropriately.



When the output current is below the Electronic thermal level setting [bC110], the electronic thermal load rating integration data can be reduced according to the heat emission from the motor. ([bC112]=01)

Ex. 1) Subtraction mode (for [bC112]=01, [bC113]=600 s(10 min.))

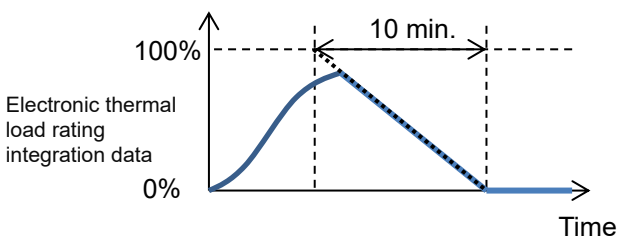

*) Electronic thermal load rating of the motor can be monitored at the [dA-42].

Parameters.

Name	Code	Data range (unit)	Description
Electronic thermal decrease function enable, 1st-motor	[bC112]	00	Constant period mode: The electronic thermal load rating integration data only increases. It is automatically cleared every 10 minutes.
		01	Subtraction mode: The electronic thermal load rating integration data is increases or decreases according to the heat emission of the motor.
Electronic thermal decreasing time, 1st-motor	[bC113]	1 to 1000 (sec)	Set according to the heat emission time of the motor. Sets the time for the integration data to change form 100% to 0%.



- When the output frequency coincides with the free-electronic thermal frequency 2 [bC122], the electronic thermal time-limited characteristics are given in the lower part of Example 4.
- In Example 4, the [E005] trip occurs after 60 sec when an electric current of 150% of the designated free- electronic thermal current 2 [bC123] is continuously flowing.



- When [bC121],[bC123] and [bC125] are set to the default (0.00) and [bC111] electronic thermal is set to 02 and driven, the [E005] trip occurs.
- Be sure to set [bC125][bC123] and [bC121] in this sequence when to set free electronic thermal.



- The setting of the subtraction characteristic shown figure below are for the electronic thermal of the motor. Note that the subtraction characteristic of the electronic thermal of the inverter is implemented separately and cannot be changed by user parameters.
- Appropriate setting should be made for the using motor.
- In case of [bC112]=00, resetting cannot be made in 10 sec after occurrence of the [E005] error.
- If want to set same as SJ700, set 00 to [bC112].

Ex. 2) Constant period mode (for [bC112]=00)

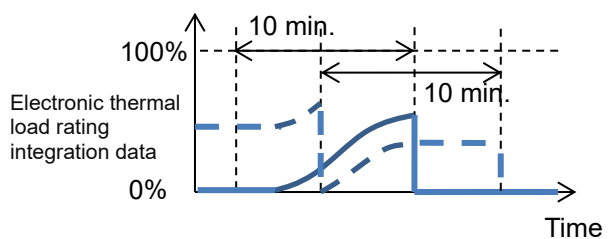

*) In the constant period mode, there are two integrated data as shown above. If either one reaches 100%, the [E005] trip occurs. And the data is cleared every 10 minutes.

- To store the Electronic thermal load rating integration data to non-volatile memory even after the power is shut off or the reset is turned on.



- I want to continue the motor thermal protection even after the power supply is shut off and the system is restarted.



- When [bC-14] is 01, even if the inverter is restarted immediately after power off or trip reset, the electronic thermal protection of the motor is continued without clearing the electronic thermal load rating integration data.
When the power is turned off or the trip is reset, the electronic thermal load rating integration data is stored in the memory and is reloaded after the power is turned on or the reset process is end.



- When the data stored function is used, the integration data are held even if the inverter is powered off for a long period of time, and a risk of occurrence of an error would increase. After it is powered on, a short-time operation could cause an error.

Name	Code	Data	Description
Store electronic thermal counter at power-off	[bC-14]	00	Not stored : The electronic thermal load rating integration data is cleared at the power supply shut-off and resetting.
		01	Stored : The electronic thermal load rating integration data is not cleared and subtracted only in the subtraction mode.

■ Related functions.



- I want to check the electronic thermal load rating integration data of the motor.



- It can be monitored by the Electronic thermal load rating monitor (Motor) [dA-42].
- If want to output a warning signal when the electronic thermal exceeds a certain level, set the output terminal function 026 [THM] and the Electronic thermal warning level (Motor) [CE-30].

For details, see “12.19.8 Outputting a Warning Before Thermal Protection of the Motor”



- I want to check the electronic thermal load rating integration data of the inverter.



- It can be monitored by the Electronic thermal warning level (Inverter) [dA-43].
- If want to output a warning signal when the electronic thermal exceeds a certain level, set the output terminal function 027 [THC] and the Electronic thermal warning level (Inverter) [CE-31].

For details, see “12.19.9 Outputting a Warning Before Thermal Protection of the Inverter”

12.7.2 Monitoring of Motor Temperature

Q

- I want to make thermal protection of motor.
- I want to make temperature protection of the motor using a thermistor resistance.

A

- The temperature protection of an external device can be made by connecting a thermistor installed in the motor or other external device to the inverter and setting the function of the thermistor.
- The external thermistor should be wired between the control terminals TH+ and TH-.
- Set the [Cb-40] Thermistor type selection and the [bb-70] Thermistor error level accordance with the thermistor's specifications.
- When the thermistor resistance value due to the motor temperature reaches the [bb-70] thermistor error level, the [E035] thermistor error occurs.
- When [Cb-40] is set to 02, [dA-38] motor temperature monitor indicates the detected temperature of the motor.



- When an external thermistor is not connected, a trip occurs if the thermistor selection [Cb-40] is set to 01.
- To use this function, the wiring distance between the motor and the inverter has to be 20 m or shorter. Since the current flowing in the thermistor is very weak, a measure such as wiring separation should be taken to prevent noise from the motor current.
- When [Cb-40] is set to a value other than 02, [dA-38] motor temperature monitor indicates 0 °C.

Parameters.

Name	Code	Data range (unit)	Description
Thermistor error level	[bb-70]	0 to 10000 (Ω)	Sets the resistance for the temperature at which a trip occurs in accordance with the thermistor resistance specifications. Effective when [Cb-40]=01, 02
Thermistor type selection	[Cb-40]	00	Disabled
		01	Enabled Positive temperature coefficient resistor (PTC)
		02	Enabled Negative temperature coefficient resistor (NTC)
Thermistor gain adjustment	[Cb-41]	0.0 to 1000.0	Used as a gain adjustment for the detected temperature.
Motor temperature monitor	[dA-38]	-20.0 to 200.0 ($^{\circ}\text{C}$)	Indicates the detected motor temperature.

12.8 Using Functions of Accelerating or Decelerating Motor Speed

12.8.1 Change Acceleration Time and Deceleration Time



- I want to accelerate faster to improve the response of the motor.
- I want to set a long acceleration time to prevent overcurrent errors.
- I want to set a long deceleration time to prevent overvoltage errors.
- I want to slow down the acceleration and deceleration because of the load inertia is large.



- Set up the acceleration time and the deceleration time of the motor. If want to slower acceleration or deceleration of the motor, set to longer time to each parameter. If want to faster, set inversely shorter time.
- The setting acceleration time is the time of increases from 0 Hz to the maximum frequency and deceleration time is the time of decreases from maximum frequency to the 0 Hz. Note that the times are not between 0 Hz and requery reference.
- In the initial state, the Acceleration time setting 1 [AC120] and the Deceleration time setting 1 [AC122] are enabled.
- The currently enabled acceleration time and deceleration time can be monitored with [FA-10] and [FA-12].



- When the function of acceleration or deceleration action cancellation 071 [LAC] is selected as the input terminal function and turned ON, the acceleration or deceleration time will become 0 sec and the output frequency will be made instantaneously to follow the frequency reference.
- The input source of command for the acceleration or deceleration time can be selected below with [AC-01].
 - Parameter setting / Option-1 to 3 / Program function EzSQ
- The acceleration or deceleration time can be changed for the each frequency references given by the multi-speed function. For details, see "12.4.10 Multi-Stage Switching of Frequency References".

Parameters.

Name	Code	Data range (unit)	Description
Async. Motor maximum frequency setting, 1st-motor	[Hb105]	10.00 to 590.00(Hz)	Set the rated maximum frequency of the motor.
Sync. Motor Maximum frequency setting, 1st-motor	[Hd105]		
Acceleration time setting 1, 1st-motor	[AC120]	0.00 to 3600.00(s)	Set the acceleration time when increasing from the 0 Hz to maximum frequency.
Deceleration time setting 1, 1st-motor	[AC122]	0.00 to 3600.00(s)	Set the deceleration time when decreasing from the maximum frequency to 0 Hz.
Acceleration/Deceleration time input source selection	[AC-01]	00 to 04	00(Parameter setting) / 01(Option-1) / 02(Option-2) / 03(Option-3) / 04(Function EzSQ)
Input terminal function	[CA-01] to [CA-11]	071	The acceleration and deceleration times become 0 sec while [LAC] is ON. OFF: Function disabled. ON: Function enabled. The accel/decel time becomes 0.
Acceleration time setting or monitor	[FA-10]	0.00 to 3600.00(s)	Display the currently enabled acceleration time.
Deceleration time setting or monitor	[FA-12]	0.00 to 3600.00(s)	Display the currently enabled deceleration time.

- An actual example of setting up the acceleration or deceleration time.

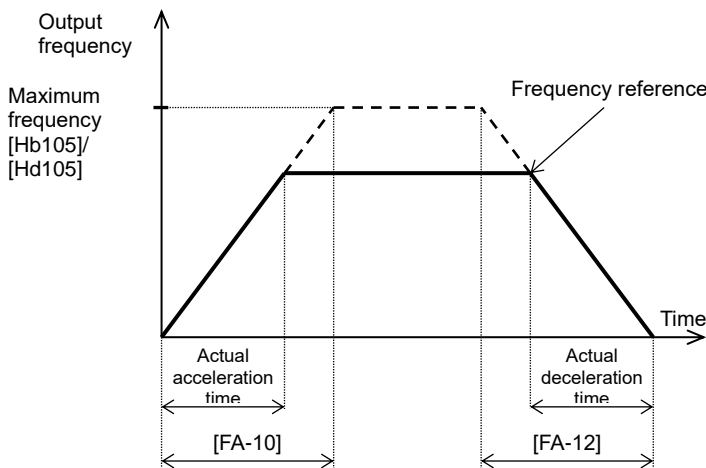

- However short the acceleration or deceleration time is set, the actual acceleration or deceleration of the motor cannot be shorter than the minimum acceleration or deceleration time that is determined by the moment of inertia J of the mechanical system and the motor torque. An act of acceleration or deceleration in a shorter time than the minimum acceleration or deceleration time may cause the [E001] Overcurrent error, [E005] Motor over load error, [E007] Overvoltage error and etc to happen.

Acceleration time t_s

$$t_s = \frac{(J_L + J_M) \times N_M}{9.55 \times (T_s - T_L)}$$

Deceleration time t_B

$$t_B = \frac{(J_L + J_M) \times N_M}{9.55 \times (T_B + T_L)}$$

J_L : Moment of inertia J ($\text{kg} \cdot \text{m}^2$) of the load converted into that of the motor shaft.

J_M : Moment of inertia J ($\text{kg} \cdot \text{m}^2$) of the motor itself.

N_M : Revolution speed of the motor (r/min)

T_s : Maximum acceleration torque (N·m) of the motor driven by the inverter.

T_B : Maximum deceleration torque (N·m) of the motor driven by the inverter.

T_L : Required operating torque (N·m)
(Load torque (constant speed) (N·m))

12.8.2 Switching Accel. / Decel. Time by 2-Stage Accel./ Decel. Function

Q

- I want to change the acceleration/deceleration time by an external signal to the input terminal.
- I want to accelerate slowly at low speed and further accelerate when the speed exceeds a predetermined value since large torque is required at the time of startup.
- I want to accelerate / decelerate the motor fast in forward rotation and slowly accelerate / decelerate in reverse rotation.

A

- Using the 2-stage acceleration / deceleration function, the acceleration / deceleration time can be changed during operation by the signal in to input terminal, frequency reference, or direction command.
- When [AC115] = 00, setting 031 [2CH] in any of the [CA-01] to [CA-11] and turning OFF/ON the input terminal allows you to switch the acceleration or deceleration time.
⇒ (Example 1)

!

- When the input terminal is used for switching accel/decel, to assign 031 [2CH] to any of [CA-01] to [CA-11].

- When [AC115] = 01, the acceleration time or deceleration time can be switched when the actual frequency reference crossing the set value [AC116] or [AC117].
⇒ (Example 2)
- When [AC115] = 02, the acceleration or deceleration time can be switched between that for the forward revolution and that for the reverse revolution.
⇒ (Example 3)

Parameters.

Name	Code	Data range (unit)	Description
Async. Motor maximum frequency setting, 1st-motor	[Hb105]	10.00 to 590.00(Hz)	Set the maximum frequency
Sync. Motor Maximum frequency setting, 1st-motor	[Hd105]		
Acceleration time setting 1, 1st-motor	[AC120]	0.00 to 3600.00(s)	Set the acceleration time when increasing from the 0 Hz to maximum frequency.
Deceleration time setting 1, 1st-motor	[AC122]	0.00 to 3600.00(s)	Set the deceleration time when decreasing from the maximum frequency to 0 Hz.
Acceleration time setting 2, 1st-motor	[AC124]	0.00 to 3600.00(s)	Set the acceleration time when increasing from the 0 Hz to maximum frequency.
Deceleration time setting 2, 1st-motor	[AC126]	0.00 to 3600.00(s)	Set the deceleration time when decreasing from the maximum frequency to 0 Hz.
Accel/Decel change trigger, 1st-motor	[AC115]	00	Switching by [2CH] terminal. (Example 1)
		01	Switching by 2-stage frequency. (Example 2)
		02	Switching when the revolution direction is changed between forward and reverse. (Example 3)
Accel1 to Accel2 frequency transition point, 1st-motor	[AC116]	0.00 to 590.00(Hz)	Using when the [AC115] Accel/Decel change trigger is 01.
Decel1 to Decel2 frequency transition point, 1st-motor	[AC117]	0.00 to 590.00(Hz)	Using when the [AC115] Accel/Decel change trigger is 01..
Acceleration/Deceleration time input source selection	[AC-01]	00	Accel/Decel time input source are " Parameter setting " of the operator keypad.
Input terminal function	[CA-01] to [CA-11]	031	[2CH] 2-stage acceleration or deceleration function. When [AC115] = 00, OFF: The acceleration or deceleration command is selected by [AC-01]. ON: [AC124]/[AC126] is forcefully enabled.

A

- How to switching of the acceleration or deceleration time can be selected the [AC115] following three methods:
 - Turn ON / OFF of the [2CH] input terminal;
 - Any given set frequency [AC116] / [AC117];
 - When revolution direction is changed:
- Described below is an exemplar case of switching between the acceleration or deceleration time 1 and the acceleration or deceleration time 2.

!

- The set time of accel. / decel. is the time between 0 Hz and maximum frequency. Each of the set times are the corresponding following.
 - Acceleration time 1: [AC120];
 - Deceleration time 1: [AC122];
 - Acceleration time 2: [AC124];
 - Deceleration time 2: [AC126].

(Example 1) In the case of setting [AC115] = 00

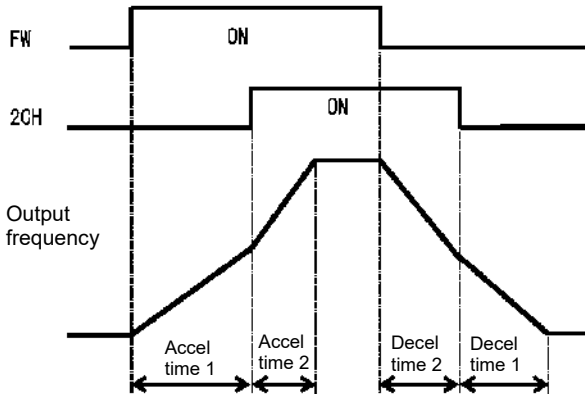

(Example 2) In the case of setting [AC115] = 01

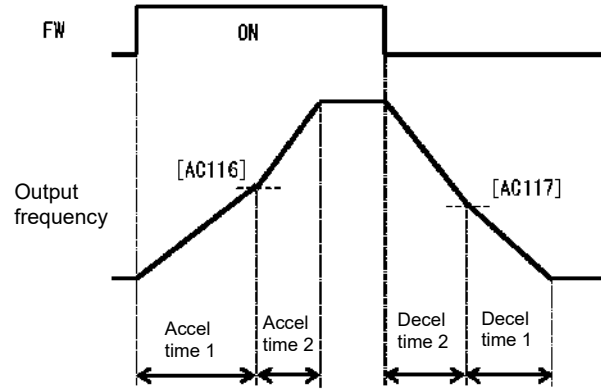

(Example 3) In the case of setting [AC115] = 02

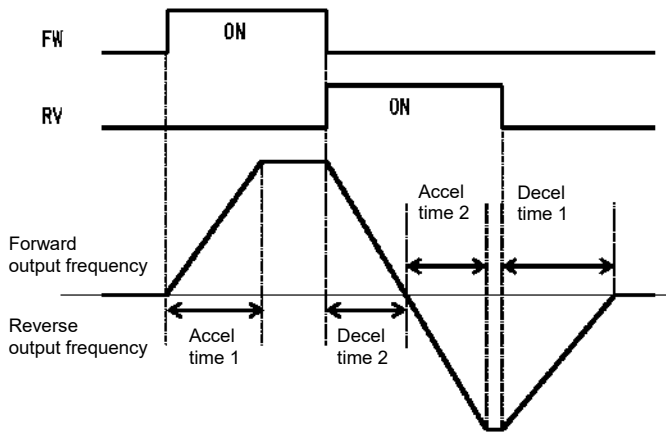

12.8.3 Switching of Accel / Decel Time for Each Multi-Stage Speed Reference

Q

- I want to use the multi-stage speed function with different acceleration or deceleration times for each speed.
- I want to accelerate or decelerate to a predetermined frequency by using a plurality of different acceleration or deceleration times.

A

- Setting up this function allows the acceleration or deceleration time to be changed in correspondence to the multi-stage speed terminal.

Parameters.



- When using the input terminal function to switch the multi-stage speed, operation should be performed by assigning 003 [CF1] to 006 [CF4] or 007 [SF1] to 013 [SF7] to any of [CA-01] to [CA-11].
- When the Acceleration / Deceleration selection [AC-02] is 01, the 2-stage acceleration / deceleration function is disabled.

Name	Code	Data range (unit)	Description
Acceleration / Deceleration selection	[AC-02]	00	The acceleration or deceleration time follows [AC120] / [AC122] or [AC124] / [AC126] (when 2-stage acceleration or deceleration function is enabled).
		01	The acceleration or deceleration time will be switched in accordance with the each multi-stage speed.
Multi-speed 1 to 15 setting	[Ab-11] to [Ab-25]	0.00 to 590.00 (Hz)	Set the multi-stage speeds to 1st speed [Ab-11] to 15th speed [Ab-25].
Accel. time for Multi-speed 1 to 15	[AC-30], [AC-34], [AC-38], [AC-42], [AC-46], [AC-50], [AC-54], [AC-58], [AC-62], [AC-66], [AC-70], [AC-74], [AC-78], [AC-82], [AC-86]	0.00 to 3600.00(s)	Set acceleration times for each multi-stage speed.
Decel. time for Multi-speed 1 to 15	[AC-32], [AC-36], [AC-40], [AC-44], [AC-48], [AC-52], [AC-56], [AC-60], [AC-64], [AC-68], [AC-72], [AC-76], [AC-80], [AC-84], [AC-88]	0.00 to 3600.00(s)	Set deceleration times for each multi-stage speed.
Multi-speed operation selection	[Ab-03]	00	Corresponding to 16-speed binary operation. 003[CF1] to 006[CF4]
		01	Corresponding to 8-speed bit operation. 007[SF1] to 013[SF7]
Input terminal function	[CA-01] to [CA-11]	003 to 006/ 007 to 013	Assign the multi-speed input terminal function. 003[CF1] to 006[CF4]/ 007[SF1] to 013[SF7]

A

- Shown below are the multi-stage speed function table for binary operation (when [Ab-03] = 00) and bit operation (when [Ab-03] = 01).

■ Table for binary operation [Ab-03]=00:
Input terminal function 003 [CF1] to 006 [CF4].

Multiple speeds	CF4	CF3	CF2	CF1
0th speed	OFF	OFF	OFF	OFF
1st speed	OFF	OFF	OFF	ON
2nd speed	OFF	OFF	ON	OFF
3rd speed	OFF	OFF	ON	ON
4th speed	OFF	ON	OFF	OFF
5th speed	OFF	ON	OFF	ON
6th speed	OFF	ON	ON	OFF
7th speed	OFF	ON	ON	ON
8th speed	ON	OFF	OFF	OFF
9th speed	ON	OFF	OFF	ON
10th speed	ON	OFF	ON	OFF
11th speed	ON	OFF	ON	ON
12th speed	ON	ON	OFF	OFF
13th speed	ON	ON	OFF	ON
14th speed	ON	ON	ON	OFF
15th speed	ON	ON	ON	ON

■ Table for bit operation [Ab-03] = 01.
Input terminal function 007 [SF1] to 013 [SF7].

Multiple speeds	SF7	SF6	SF5	SF4	SF3	SF2	SF1
0th speed	OFF	OFF	OFF	OFF	OFF	OFF	OFF
1st speed	-	-	-	-	-	-	ON
2nd speed	-	-	-	-	-	ON	OFF
3rd speed	-	-	-	-	ON	OFF	OFF
4th speed	-	-	-	ON	OFF	OFF	OFF
5th speed	-	-	ON	OFF	OFF	OFF	OFF
6th speed	-	ON	OFF	OFF	OFF	OFF	OFF
7th speed	ON	OFF	OFF	OFF	OFF	OFF	OFF

Note : Do not evaluate ON / OFF of "-" in the table above.

■ Exemplar operation.

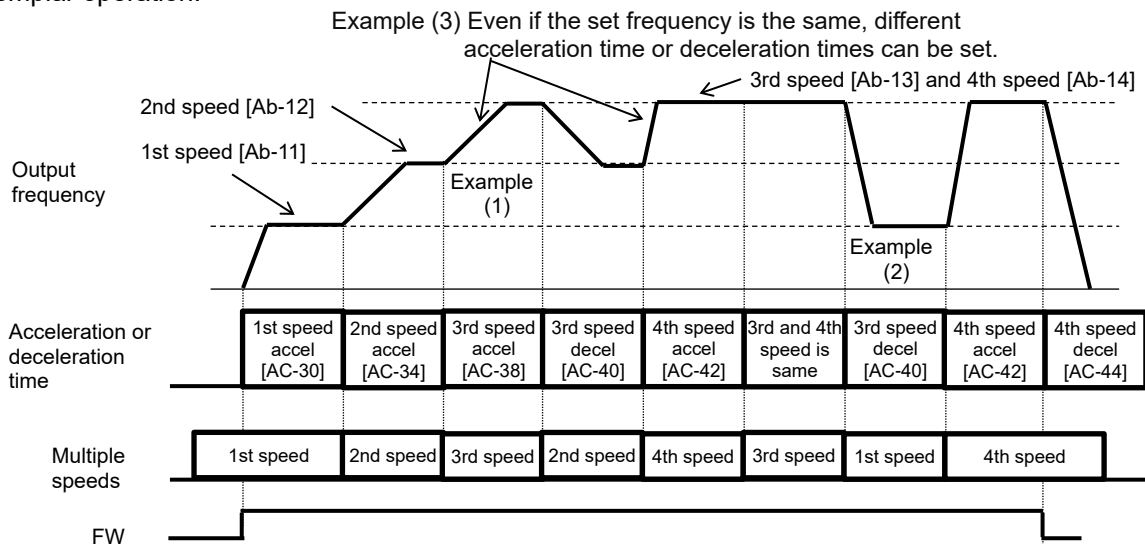

Example (1) If the multi-speed 3rd speed is selected with acceleration direction, the selected acceleration time is the [AC-38] Accel time for Multi-speed 3.

Example (2) When the multi-speed 1st speed is selected with deceleration direction during multi-speed 3 speed running, the selected deceleration time is the [AC-40] Decel time for Multi-speed 3.

Example (3) When the multi-speed 3 and multi-speed 4 are set the same and the respective acceleration time settings [AC-38] and [AC-42] are set differently, the same frequency reference with different acceleration times is possible as shown figure above.

■ Acceleration or deceleration time table.

- The following table shows the multi-speed commands and their corresponding acceleration or deceleration times.

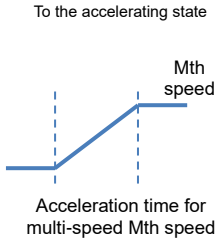
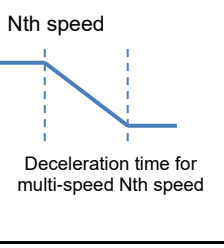
Setting state	Multi-speed command	Command state	Acceleration or deceleration time to be used
The frequency after a speed is ON will be higher than the speed before that. To the accelerating state  Acceleration time for multi-speed Mth speed	1st speed ON	Multi-speed 1st speed [Ab-11] > Frequency before 1st speed is ON	Accel. time for Multi-speed 1 [AC-30]
	2nd speed ON	Multi-speed 2nd speed [Ab-12] > Frequency before 2nd speed is ON	Accel. time for Multi-speed 2 [AC-34]
	3rd speed ON	Multi-speed 3rd speed [Ab-13] > Frequency before 3rd speed is ON	Accel. time for Multi-speed 3 [AC-38]
	4th speed ON	Multi-speed 4th speed [Ab-14] > Frequency before 4th speed is ON	Accel. time for Multi-speed 4 [AC-42]
	5th speed ON	Multi-speed 5th speed [Ab-15] > Frequency before 5th speed is ON	Accel. time for Multi-speed 5 [AC-46]
	6th speed ON	Multi-speed 6th speed [Ab-16] > Frequency before 6th speed is ON	Accel. time for Multi-speed 6 [AC-50]
	7th speed ON	Multi-speed 7th speed [Ab-17] > Frequency before 7th speed is ON	Accel. time for Multi-speed 7 [AC-54]
	8th speed ON	Multi-speed 8th speed [Ab-18] > Frequency before 8th speed is ON	Accel. time for Multi-speed 8 [AC-58]
	9th speed ON	Multi-speed 9th speed [Ab-19] > Frequency before 9th speed is ON	Accel. time for Multi-speed 9 [AC-62]
	10th speed ON	Multi-speed 10th speed [Ab-20] > Frequency before 10th speed is ON	Accel. time for Multi-speed 10 [AC-66]
	11th speed ON	Multi-speed 11th speed [Ab-21] > Frequency before 11th speed is ON	Accel. time for Multi-speed 11 [AC-70]
	12th speed ON	Multi-speed 12th speed [Ab-22] > Frequency before 12th speed is ON	Accel. time for Multi-speed 12 [AC-74]
	13th speed ON	Multi-speed 13th speed [Ab-23] > Frequency before 13th speed is ON	Accel. time for Multi-speed 13 [AC-78]
	14th speed ON	Multi-speed 14th speed [Ab-24] > Frequency before 14th speed is ON	Accel. time for Multi-speed 14 [AC-82]
	15th speed ON	Multi-speed 15th speed [Ab-25] > Frequency before 15th speed is ON	Accel. time for Multi-speed 15 [AC-86]
	No multi-speed	Other than those above	Acceleration time setting 1, 1st-motor [AC120]
The frequency after a speed is OFF will be lower than the speed before that. To the decelerating state  Deceleration time for multi-speed Nth speed	1st speed OFF	Multi-speed 1st speed [Ab-11] > Frequency after 1st speed is OFF	Decel. time for Multi-speed 1 [AC-32]
	2nd speed OFF	Multi-speed 2nd speed [Ab-12] > Frequency after 2nd speed is OFF	Decel. time for Multi-speed 2 [AC-36]
	3rd speed OFF	Multi-speed 3rd speed [Ab-13] > Frequency after 3rd speed is OFF	Decel. time for Multi-speed 3 [AC-40]
	4th speed OFF	Multi-speed 4th speed [Ab-14] > Frequency after 4th speed is OFF	Decel. time for Multi-speed 4 [AC-44]
	5th speed OFF	Multi-speed 5th speed [Ab-15] > Frequency after 5th speed is OFF	Decel. time for Multi-speed 5 [AC-48]
	6th speed OFF	Multi-speed 6th speed [Ab-16] > Frequency after 6th speed is OFF	Decel. time for Multi-speed 6 [AC-52]
	7th speed OFF	Multi-speed 7th speed [Ab-17] > Frequency after 7th speed is OFF	Decel. time for Multi-speed 7 [AC-56]
	8th speed OFF	Multi-speed 8th speed [Ab-18] > Frequency after 8th speed is OFF	Decel. time for Multi-speed 8 [AC-60]
	9th speed OFF	Multi-speed 9th speed [Ab-19] > Frequency after 9th speed is OFF	Decel. time for Multi-speed 9 [AC-64]
	10th speed OFF	Multi-speed 10th speed [Ab-20] > Frequency after 10th speed is OFF	Decel. time for Multi-speed 10 [AC-68]
	11th speed OFF	Multi-speed 11th speed [Ab-21] > Frequency after 11th speed is OFF	Decel. time for Multi-speed 11 [AC-72]
	12th speed OFF	Multi-speed 12th speed [Ab-22] > Frequency after 12th speed is OFF	Decel. time for Multi-speed 12 [AC-76]
	13th speed OFF	Multi-speed 13th speed [Ab-23] > Frequency after 13th speed is OFF	Decel. time for Multi-speed 13 [AC-80]
	14th speed OFF	Multi-speed 14th speed [Ab-24] > Frequency after 14th speed is OFF	Decel. time for Multi-speed 14 [AC-84]
	15th speed OFF	Multi-speed 15th speed [Ab-25] > Frequency after 15th speed is OFF	Decel. time for Multi-speed 15 [AC-88]
	No multi-speed	Other than those above	Deceleration time setting 1, 1st-motor [AC122]



- The switching timing of frequency reference by multi-speed input terminals is different from that of the deceleration time.

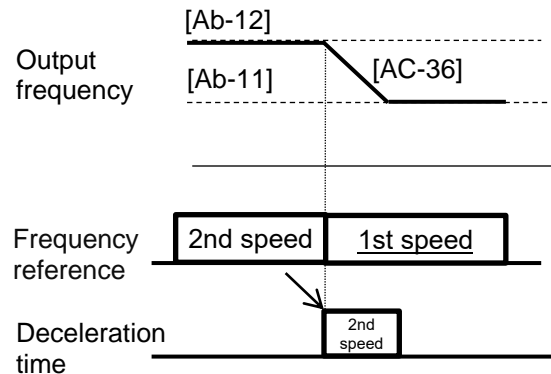
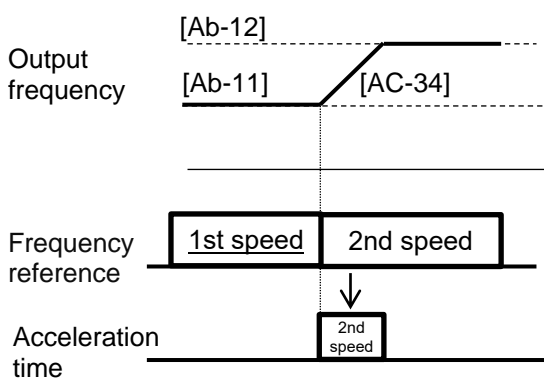

12.8.4 Stop Acceleration or Deceleration and Hold the Actual Frequency Reference



- I want to temporarily stop acceleration until the motor speed follows the frequency reference because torque is required for startup.
- I want to temporarily stop deceleration until the motor speed drops follows frequency reference in order to facilitate that allows the complete stop of the motor when the load is large.



- Use the hold function, which is more effective for a mechanical system that has a larger moment of inertia.
- The acceleration-hold is the function that is to withhold further acceleration until the motor slip becomes small at start. Use this function when an over current error will be happened at the start of the motor.
- The deceleration-hold is the function that is to withhold further deceleration until the motor slip becomes small enough. Use this function when an over voltage error will be happened during deceleration.



- This function works for all patterns regardless of the contents of the Acceleration curve selection [AC-03] and the Deceleration curve selection [AC-04].

■ Hold at any set frequency for the set time.

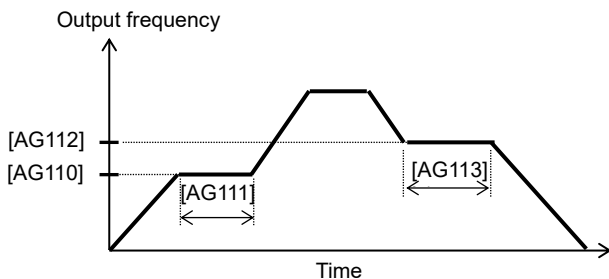

■ To hold the frequency by use of the input terminal 100 [HLD] terminal function.

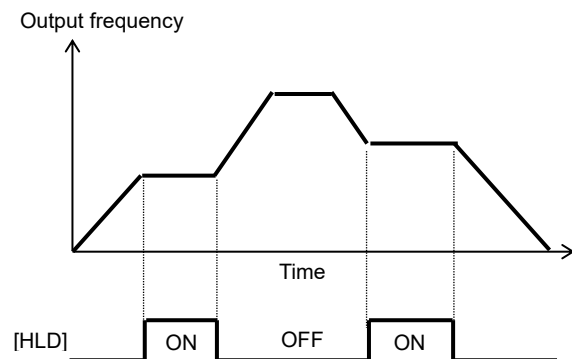

■ Parameters.

Name	Code	Data range (unit)	Description
Acceleration stop frequency setting, 1st-motor	[AG110]	0.00 to 590.00(Hz)	Setting the frequency at which the acceleration is withheld. A setting of 0.00 is not valid.
Acceleration stop time setting, 1st-motor	[AG111]	0.00 to 60.00(s)	Setting the length of time for which the acceleration is withheld.
Deceleration stop frequency setting, 1st-motor	[AG112]	0.00 to 590.00(Hz)	Setting the frequency at which the deceleration is withheld. A setting of 0.00 is not valid.
Deceleration stop time setting, 1st-motor	[AG113]	0.00 to 60.00(s)	Setting the length of time for which the deceleration is withheld.
Input terminal function	[CA-01] to [CA-11]	100	Using the acceleration or deceleration hold [HLD] function.

12.8.5 Change the Acceleration or Deceleration Pattern



- I want to reduce the load collapse caused by the impact of sudden movements such as elevators and conveyors.
- I want to reduce the shock when the motor starts and stops.
- I want to change the acceleration gradient according to the winding amount and the feed amount.



- Setting a(n) acceleration or deceleration pattern is possible that suit each system.
- Setting the acceleration pattern selection and the deceleration pattern selection can be done independently of each other by the [AC-03] and [AC-04], respectively.
- When using a(n) acceleration / deceleration pattern other than a linear line (00), stable operation can be performed with fixed frequency references such as parameter setting and multi-stage speed references.
- Even if a acceleration or deceleration pattern is set, the acceleration time is set increasing time from the 0 Hz to maximum frequency and the deceleration time is set decreasing time from the maximum frequency to 0 Hz.



- When the acceleration / deceleration pattern is changed, the acceleration / deceleration gradient may become steep in some areas. If the [E001] Overcurrent error or the [E007] Overvoltage error occurs, it is necessary to adjust the acceleration / deceleration time.
- If the acceleration / deceleration pattern is set to other than the linear (00), an impact may occur due to recalculation of the acceleration / deceleration pattern by changing the frequency reference value during acceleration / deceleration.
- If the acceleration / deceleration pattern is set to other than the linear (00), use the other than analog frequency references. An unsteady frequency reference value may cause recalculation many times of the acceleration or deceleration pattern, which may prolong the actual acceleration or deceleration time.

■ Pattern selection.

Select a pattern for each of patterns by referring to the following table.

Set value	00	01	02	03	04
Curve	Linear	S-curve	U-curve	Reverse U-curve	EL-S-curve
[AC-03] (Acceleration)					
[AC-04] (Deceleration)					
Description	Linear acceleration / deceleration up to the frequency reference value.	Effective in the prevention of load collapse in lifts or on conveyors, for example.	Effective when a winder or the like needs to be wound from being cut. Usable for 1-shot winding/feeding.		Providing a shockless start / stop similar to the S-curve, and the middle part is linear acceleration / deceleration.

- Curve constant (degree of bulging) of pattern.
- When the acceleration / deceleration pattern is selected with [AC-03] / [AC-04], the curve bulge can be set with the acceleration / deceleration curve constant [AC-05] / [AC-06].

The figure below shows examples of S-curve, U-curve and Reverse U-curve, and curve constants set to 2 and 10, respectively.

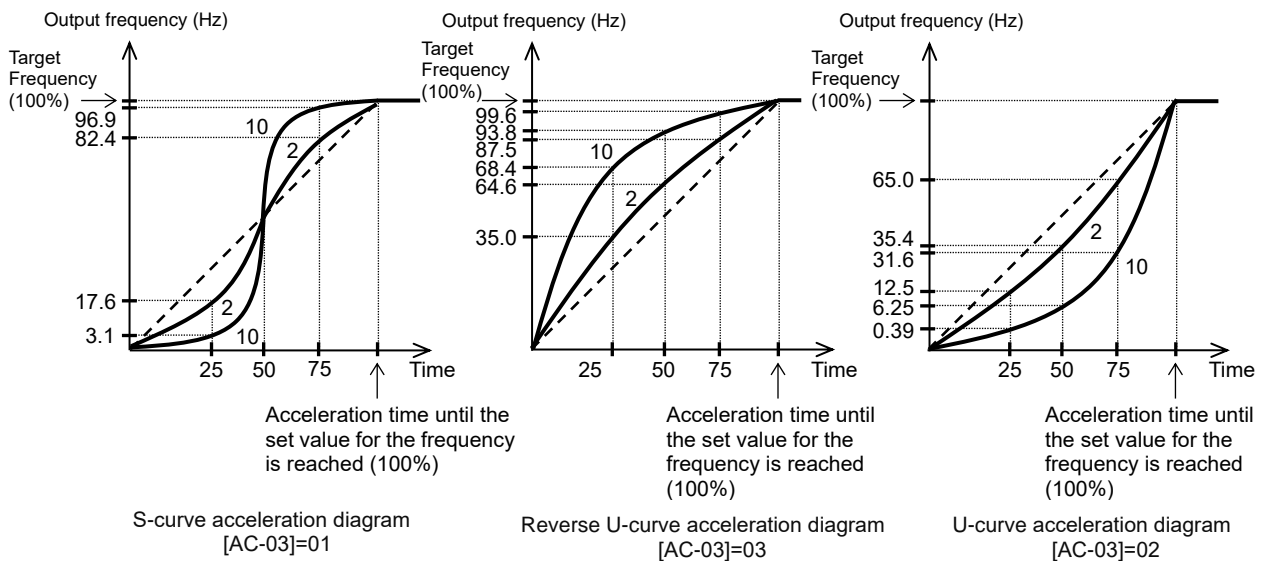

- EL-S-curve curvature.
- Use of an EL-S-curve allows the curvature settings [AC-08] to [AC-11] for acceleration/deceleration.

- Setting all the curvatures at 50 (%) makes the EL-S-curve equivalent to an S-curve.
- When setting the pair of [AC-08] and [AC-09] or that of [AC-10] and [AC-11], set the divided values so that the total of each parameter of the pair is 100%.
- If [AC-08] = 100 and [AC-09] = 0 are set, the curve becomes same as the U-curve acceleration curve.

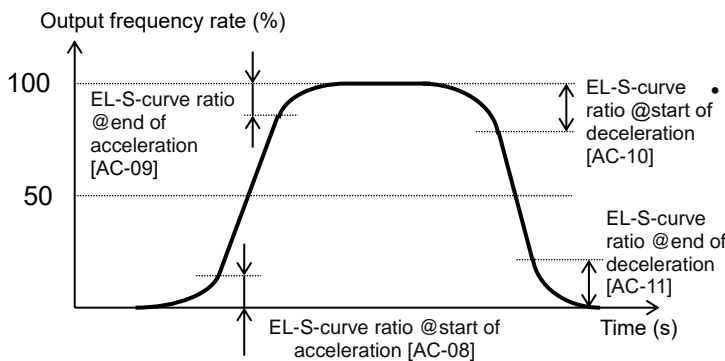

Parameters.

Name	Code	Data	Description
Acceleration curve selection	[AC-03]	00	Linear acceleration/deceleration
		01	S-curve acceleration/deceleration
		02	U-curve acceleration/deceleration
		03	Reverse U-curve acceleration/deceleration
		04	Elevator S-curve (EL-S-curve) acceleration/deceleration
Deceleration curve selection	[AC-04]	00 to 04	Same as [AC-03]
Acceleration curve constant setting	[AC-05]	1 to 10	1 (small bulging)
Deceleration curve constant setting	[AC-06]		10 (large bulging)
EL-S-curve ratio @start of acceleration	[AC-08]	0 to 100(%)	Designate the curvature of the curved sector when an EL-S-curve pattern is used. (For acceleration)
EL-S-curve ratio @end of acceleration	[AC-09]		
EL-S-curve ratio @start of deceleration	[AC-10]	0 to 100(%)	Designate the curvature of the curved sector when an EL-S-curve pattern is used. (For deceleration)
EL-S-curve ratio @end of deceleration	[AC-11]		

12.8.6 Make the Actual Speed Follow the Frequency Reference Instantaneously

Q

- I want to use the analog input value as the actual frequency reference without accel /decel time.
- I want to make the motor speed follow the frequency reference as fast as possible.

A

- If the acceleration or deceleration cancel [LAC] function is selected as the input terminal function and it is turned ON, the acceleration or deceleration time becomes ignored and the output frequency is made instantaneously to follow the set frequency.

!

- As the use of the acceleration or deceleration cancellation function makes the output follow the command, a large amount of increase/decrease in the frequency demanded by the command may cause a trip.
- [LAC] function is valid for any frequency reference such as one from parameter setting, one from the communication, and so on.

Item	Parameter	Data	Description
Input terminal function	[CA-01] to [CA-11]	071	Acceleration or deceleration cancellation function [LAC] is selected. Canceling the acceleration or deceleration and making the output follow the command.

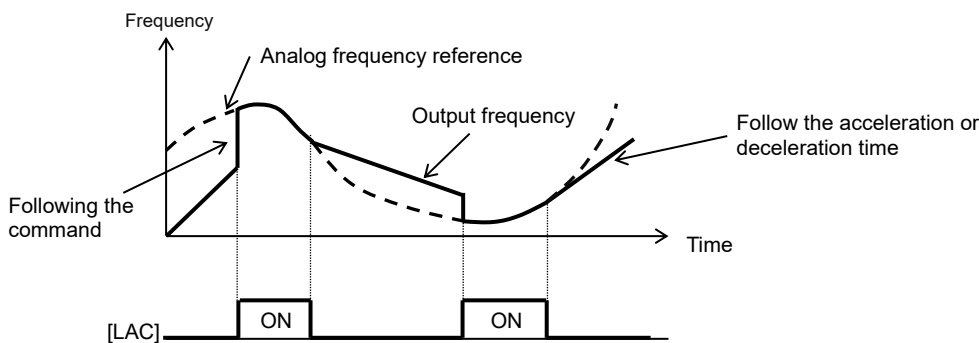

12.9 Select the Appropriate Control Mode for the Motor and Load

12.9.1 Selection of Control Mode

Q

- I want to run a fan/pump with settings that provide a better energy-saving effect.
- I want to freely change the frequency-voltage characteristics of a high-speed motor/special motor.
- I want to drive multiple motors with one inverter.
- I want to use high-torque control of conveyors or the like without using encoder feedback.
- I want to perform high torque control around 0 Hz on cranes, lifts or the like without using encoder feedback.
- I want to use torque control for mechanical stopper control and tension control.

A

- Select an appropriate motor control mode for the motor to be driven and the control mode.
- Set [AA121] = 11 or 12 to drive a synchronous motor (SM)/permanent magnet motor (PMM).
- The characteristics of the control operation may be improved by auto-tuning.
- Whether the currently-selected mode is the control mode for induction motors or that for synchronous motors (SMs)/permanent magnet motors (PMMs) can be checked by [dC-45] IM/SM(PMM) monitor.

!

- If the motor type and control mode setting do not match, the intended motor performance will not be obtained, so make sure to set it properly.
- See "12.3 Basic Settings of Motor" for checking.
- To drive multiple induction motors (IMs) by a single inverter, it is recommendable to use it with V/f control's constant torque characteristics.
- An exemplar selection of control mode will be shown in the following pages. Some of your systems may have more suitable modes than what is selected as the example.

■ Parameters.

Item	Parameter	Data	Description
Control mode selection, 1st-motor	[AA121]	00	V/f control-constant torque characteristics (IM)
		01	V/f control-reducing torque characteristics (IM)
		02	V/f control-free V/f (IM)
		03	V/f control automatic torque boost (IM)
		04	V/f control-constant torque characteristics (IM) with encoder
		05	V/f control-reducing torque characteristics (IM) with encoder
		06	V/f control-free V/f (IM) with encoder
		07	V/f control automatic torque boost (IM) with encoder
		08	Sensorless vector control (IM)
		09	Zero-Hz range sensorless vector control (IM)
		10	Vector control (IM) with encoder
		11	Synchronous-start type sensorless vector control (SM (PMM))
		12	IVMS-start type sensorless vector control (SM (PMM))
IM/SM(PMM) monitor	[dC-45]	00	Induction motor IM being selected.
		01	Synchronous motor SM (permanent magnet motor PMM) being selected.

- * IM : Induction motor
 SM (PMM) : Synchronous motor (permanent magnet motor)



1 Check the motor type.

• To use a synchronous motor (SM) / permanent magnet motor (PMM). Proceed to "12.9.16 Control Synchronous Motor (Permanent Magnet Motor)"

2 Select a control mode for IM motor
Not using a encoder feedback

Applications that require a encoder feedback

• For use with generic characteristics of V/f control, proceed to "12.9.2 Drive with V/f Control (Constant Torque Characteristics)".

• To perform energy-saving operation with optimum characteristics for fans and pumps, proceed to "12.9.3 Drive with V/f Control(Reducing Torque Characteristics)".

• For use in applications where the frequency-voltage characteristics of a high-speed motor/special motor need to be changed freely as intended, proceed to "12.9.4 Drive with Free V/f Control".

• Combined function in V/f mode (reducing / constant and free V/f):
 - By using the energy saving mode, more energy savings may be possible. Refer to "12.9.6 Drive with the Energy-Saving function";
 - For a light load application but high torque is required at start-up, use the manual torque boost function. Refer to "12.9.7 Drive with Manual Torque Boost Function";

• For light load applications but high torque is required at start-up and want to automatically calculate the start-up torque according to the motor characteristics, proceed to "12.9.5 Drive with Automatic Torque Boost Control".

• For use in applications that require high torque and speed stability under heavy load such as conveyors and machine tools, proceed to "12.9.9 Drive with Sensorless Vector Control".

• For use in applications that require higher torque at startup, such as lifts and cranes, Proceed to "12.9.10 Drive with Zero-Hz Range Sensorless Vector Control".

• To use in applications where a motor with an encoder is driven and where the motor needs to be used with generic characteristics of V/f control, proceed to "12.9.11 Drive with V/f Control with Encoder(Constant Torque Characteristics)"

• For applications where it is necessary to match the motor rotation speed and command speed using a feedback encoder while performing energy-saving operation with optimal characteristics for fans and pumps, proceed to "12.9.12 Drive with V/f Control with Encoder (Reducing Torque Characteristics)".

• For applications where it is necessary to match the motor rotation speed and command speed using a feedback encoder and where the frequency-voltage characteristics need to be changed freely, proceed to "12.9.13 Drive with Free V/f Control with Encoder"

• For applications where it is necessary to match the motor rotation speed and command speed using a feedback encoder and where a high torque that is automatically calculated according to the motor characteristics is required at start-up, proceed to "12.9.14 Drive with Automatic Torque Boost Function with Encoder"

• For applications that require high torque under heavy load, and/or that require the motor speed to match the command speed, and/or that require position control, proceed to "12.9.15 Drive with Vector Control with Encoder".



• When a motor is hunting and vibrating, refer to "12.9.8 Stabilize Motor Revolution" to perform stabilization adjustment.



• To perform encoder feedback, see also "12.9.17 Use Encoder" and "12.9.18 Check the Set-Up for the Pulse Train Input"

12.9.2 Drive with V/f Control (Constant Torque Characteristics)



- I want to drive travel motion loads such as conveyors and carriages.
- I want to drive fans and pumps that constantly change the output.
- I want to drive avoid errors when the control mode is V/f with reduced torque characteristics.
- I want to drive multiple motors with one inverter.



- When a motor is hunting and vibrating, an adjustment of the [HA110] Stabilization constant may improve the state of the motor.
- When a single inverter runs multiple motors and the motors are vibrating, a downward adjustment of the [HA110] Stabilization constant may stabilize the state of the motors.



- V/f control (constant torque characteristics).
- With constant torque characteristics, the output voltage is outputted proportionally to a given command frequency along the straight line drawn from the point 0 Hz/0 V to the intersection of the base frequency and the rated voltage.
- The output voltage corresponding to a frequency range from 0 Hz to the base frequency is determined proportionally to the given frequency, but the output voltage corresponding to a frequency range from the base frequency to the maximum frequency is constant irrespective of the frequency.
- Use of the manual boost function renders the output voltage higher than that on the basic proportional line by the boost voltage. The manual boost function is effective in the case of low speeds and insufficient torque.

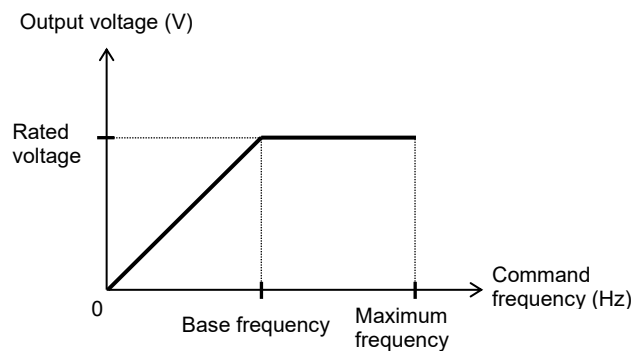

■ Parameters.

Name	Code	Data range (unit)	Description
Control mode selection, 1st-motor	[AA121]	00	To be used with the V/f control and the constant torque characteristics (IM).
Stabilization constant, 1st-motor	[HA110]	0 to 1000(%)	To adjust the control for reducing the hunting of motors.
Async. Motor base frequency setting, 1st-motor	[Hb104]	10.00 to [Hb105] (Hz)	To set the base frequency of motors.
Async. Motor maximum frequency setting, 1st-motor	[Hb105]	[Hb104] to 590.00 (Hz)	To set the maximum frequency of motors.
Async. Motor rated voltage, 1st-motor	[Hb106]	1 to 1000 (V)	Set the rated voltage of motors.

12.9.3 Drive with V/f Control (Reducing Torque Characteristics)

Q

- To reduce the output voltage in accordance with the fan/pump's characteristics in order to get a higher energy-saving effect.
- To use in a more efficient state with less vibration and lower noise, because no large torque is necessary at lower speeds.

A

- V/f control (reducing torque characteristics).
- Suitable for applications, such as a fan/pump, that require no large torque at a low-speed range.

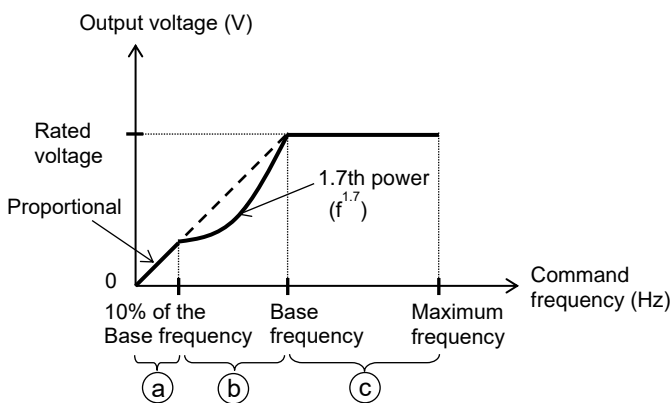

!

- When a motor is hunting and vibrating, an adjustment of the [HA110] Stabilization constant may improve the state of the motor.

- As the output voltage is low at a low-speed range, improved efficiency, lower noise, and less vibration can be expected.

Period a: Constant torque characteristics are employed for a period from 0 Hz to the frequency that is 10% of the base frequency. (e.g.) A 60-Hz base frequency yields constant torque characteristics for a range from 0 to 6 Hz.

Period b: Reducing torque characteristics are employed for a period from the frequency that is 10% of the base frequency to the base frequency. For a given frequency, the voltage on the curve of the 1.7th power to the given frequency is outputted.

Period c: The voltage has constant-output characteristics for a range from the base frequency to the maximum frequency.

■ Parameters.

Name	Code	Data range (unit)	Description
Control mode selection, 1st-motor	[AA121]	01	To be used with the V/f control and the reducing torque characteristics (IM).
Stabilization constant, 1st-motor	[HA110]	0 to 1000(%)	To adjust the control for reducing the hunting of motors.
Async. Motor base frequency setting, 1st-motor	[Hb104]	10.00 to [Hb104] (Hz)	To set the base frequency of motors.
Async. Motor maximum frequency setting, 1st-motor	[Hb105]	[Hb105] to 590.00 (Hz)	To set the maximum frequency of motors.
Async. Motor rated voltage, 1st-motor	[Hb106]	1 to 1000 (V)	Set the rated voltage of motors.

12.9.4 Drive with Free V/f Control



- To change the characteristics of V/f control in accordance with the voltage characteristics of a special motor.
- To adjust manually the voltage characteristics to optimal ones in order to save energy.



- V/f control (free V/f).
- In the free V/f set-up, any intended V/f characteristics can be set by setting the voltage and the frequency at 7 points.



- When a motor is hunting and vibrating, an adjustment of the [HA110] Stabilization constant may improve the state of the motor.
- The frequencies set by free V/f set-up have to always meet the following requirement: $f_1 \leq f_2 \leq f_3 \leq f_4 \leq f_5 \leq f_6 \leq f_7 \leq \text{base frequency}$. The initial value for each of the frequencies set by the free V/f set-up is 0 Hz. Set the maximum frequency and the base frequency first, and then set the frequencies $f_7, f_6, f_5, f_4, f_3, f_2,$ and f_1 in this order by the free V/f set-up.

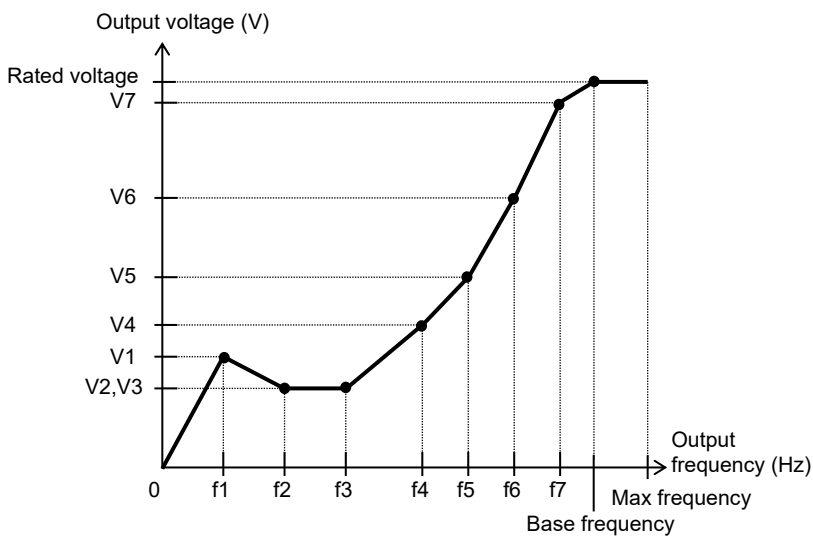

■ Parameters.

Name	Code	Data range (unit)	Description
Control mode selection, 1st-motor	[AA121]	02: Free V/f (IM)	To use the free V/f (IM)
Stabilization constant, 1st-motor	[HA110]	0 to 1000(%)	To adjust the control for reducing the hunting of motors.
Async. Motor base frequency setting, 1st-motor	[Hb104]	10.00 to [Hb105] (Hz)	To set the base frequency of motors.
Async. Motor maximum frequency setting, 1st-motor	[Hb105]	[Hb104] to 590.00 (Hz)	To set the maximum frequency of motors.
Async. Motor rated voltage, 1st-motor	[Hb106]	1 to 1000 (V)	Set the rated voltage of motors.
Free-V/f frequency 1 setting, 1st-motor	[Hb150]	0.00 to [Hb152] (Hz)	Set the frequency at each break point.
Free-V/f frequency 2 setting, 1st-motor	[Hb152]	[Hb150] to [Hb154] (Hz)	
Free-V/f frequency 3 setting, 1st-motor	[Hb154]	[Hb152] to [Hb156] (Hz)	
Free-V/f frequency 4 setting, 1st-motor	[Hb156]	[Hb154] to [Hb158] (Hz)	
Free-V/f frequency 5 setting, 1st-motor	[Hb158]	[Hb156] to [Hb160] (Hz)	
Free-V/f frequency 6 setting, 1st-motor	[Hb160]	[Hb158] to [Hb162] (Hz)	
Free-V/f frequency 7 setting, 1st-motor	[Hb162]	[Hb160] to [Hb104] (Hz)	
Free-V/f voltage 1 setting, 1st-motor	[Hb151]	0.0 to 1000.0(V)	Set the output voltage at each break point.
Free-V/f voltage 2 setting, 1st-motor	[Hb153]		
Free-V/f voltage 3 setting, 1st-motor	[Hb155]		
Free-V/f voltage 4 setting, 1st-motor	[Hb157]		
Free-V/f voltage 5 setting, 1st-motor	[Hb159]		
Free-V/f voltage 6 setting, 1st-motor	[Hb161]		
Free-V/f voltage 7 setting, 1st-motor	[Hb163]		



- Even the setting of 1000 V for all of the free V/f voltages 1 to 7 can not output a voltage for higher than the input voltage of power supply and the motor rated voltage.
- Set the each points very carefully because inappropriate characteristic settings may cause over current to happen during the acceleration or deceleration and/or may cause machine vibration or failure.

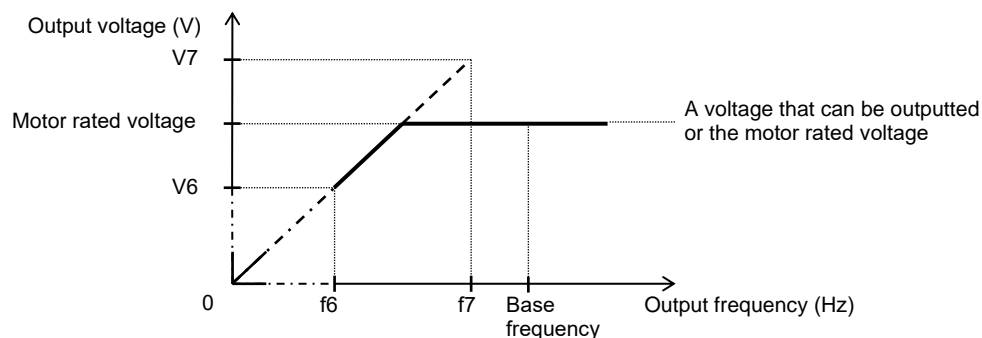

12.9.5 Drive with Automatic Torque Boost Control

Q

- To improve the delayed start of the motor from the start of the operation.
- Since the load is heavy, the rotation of the motor follows the frequency command slowly.

A

- Automatically adjust the frequency and the output voltage so as to achieve a higher torque.
- The automatic torque boost corrects the frequency and the output in order to control the motor. Accordingly, it requires the acquisition of the motor constant by means of auto-tuning or the like.

!

- When a motor is hunting and vibrating, an adjustment of the [HA110] Stabilization constant may improve the state of the motor.
- In the automatic torque boost, set the motor capacity appropriately, the number of motor poles, the base frequency, the rated voltage, and the rated current in order to perform motor control.
- When the motor performs below its potential characteristics, perform the auto-tuning and make adjustment by referring to the next page.

■ Parameters.

Name	Code	Data range (unit)	Description
Control mode selection, 1st-motor	[AA121]	03	To use the automatic torque boost (IM).
Stabilization constant, 1st-motor	[HA110]	0 to 1000(%)	To adjust the control for reducing the hunting of motors.
Async. Motor base frequency setting, 1st-motor	[Hb104]	10.00 to [Hb105] (Hz)	To set the base frequency of motors.
Async. Motor maximum frequency setting, 1st-motor	[Hb105]	[Hb104] to 590.00 (Hz)	To set the maximum frequency of motors.
Async. Motor rated voltage, 1st-motor	[Hb106]	1 to 1000 (V)	Set the rated voltage of motors.
Automatic torque boost voltage compensation gain, 1st-motor	[HC101]	0 to 255 (%)	To adjust the amount of the voltage added by the automatic torque boost.
Automatic torque boost slip compensation gain, 1st-motor	[HC102]	0 to 255 (%)	To adjust the amount of the frequency added by the automatic torque boost.

Phenomenon▶	Estimated cause(s)▶	Exemplar measures to be taken
Slower motor revolution at low speeds than what is expected.	<ul style="list-style-type: none"> • Insufficient output voltage, which in turn renders the torque insufficient. • Insufficient frequency correction, which in turn renders the torque insufficient. 	<ul style="list-style-type: none"> • Make an adjustment by incrementing the automatic torque boost voltage compensation gain [HC101] by approximately 5% each. • Make an adjustment by incrementing the automatic torque boost slip compensation gain [HC102] by approximately 5% each.
A heavy load lowers the revolution frequency of the motor.	<ul style="list-style-type: none"> • Insufficient frequency correction, which in turn renders the torque insufficient. 	<ul style="list-style-type: none"> • Make an adjustment by incrementing the automatic torque boost slip compensation gain [HC102] by approximately 5% each.
A heavy load raises the revolution frequency of the motor.	<ul style="list-style-type: none"> • An excessive frequency correction raises the frequency. 	<ul style="list-style-type: none"> • Make an adjustment by decrementing the automatic torque boost slip compensation gain [HC102] by approximately 5% each.
With a heavy load, an acceleration causes an over current.	<ul style="list-style-type: none"> • An excessive voltage correction increases the current. • An excessive frequency correction raises the frequency. 	<ul style="list-style-type: none"> • Make an adjustment by decrementing the automatic torque boost voltage compensation gain [HC101] by approximately 5% each. • Make an adjustment by decrementing the automatic torque boost slip compensation gain [HC102] by approximately 5% each.



- When the rotation of the motor is obstructed by the motor lock caused by the brake or foreign matter, the Overcurrent error or etc. will occur. Therefore, when the phenomenon cannot be improved by the adjustments described above, the cause may be found by checking the motor and its surroundings, and the situation may be improved.
- If an application of load results in a great amount of change in output frequency monitor [dA-01], the function which automatically changes the output frequency may be work. For example the overload limiting function, the instantaneous power failure non-stop function, the over voltage suppression function, and others. For details, see "Chapter 18 Tips/FAQ/Troubleshooting"

12.9.6 Drive with the Energy-Saving Function



- I want to perform more energy-saving operation in applications such as fans and pumps.



- The energy-saving function automatically adjusts the inverter to the minimum output power during constant speed operation. Suitable for the load corresponding to the reducing torque characteristics of a fan and pump.
- For automatic energy saving operation, set 01 to the [Hb145] Eco drive enable. The response and the accuracy can be adjusted by the [Hb416] Eco drive response adjustment.



- Because this function is implemented by relatively slow control, a rapid change in load, such as an impact load, may stall the motor and cause an over current trip or etc.
- This function works in V/f control (constant torque characteristics), V/f control (reducing torque characteristics), and free V/f control. ([AA121]=00,01,02,04,05,06)

Parameters.

Name	Code	Data range (unit)	Description		
Eco drive enable, 1st-motor	[Hb145]	00: disabled; 01: enabled	Select whether or not to perform the energy-saving operation.		
Eco drive response adjustment, 1st-motor	[Hb146]	0 to 100	Setting	Response	Accuracy
			0 ↕ 100	Slow ↕ Fast	High ↕ Low

12.9.7 Drive with Manual Torque Boost Function



- To improve the delayed start of the motor from the start of the operation.
- To improve the small torque at low speeds.



- The manual torque boost function increases the output voltage by adding an extra voltage in order to achieve a higher torque at low speed.
- Basically, V/f control does not make any special compensation to control the motor. Accordingly, at low output voltages, the resistance component of the motor and/or the wiring will cause the voltage drop, which in turn lowers the voltage applied to the motor. Therefore, the manual torque boost corrects the voltage and thereby improves the lowering of the torque at the low-speed range.



- Be sure not to cause an over excitation of the motor when raising the set value for the manual torque boost. Boosting increases the flow of the current, which may burn the motor.
- As the amount of manual torque boost [Hb141], set the proportion thereof to the motor rated voltage [Hb106] (= 100 %). The set value is the maximum amount to be added at manual torque boost break point [Hb142].
- As the manual torque boost break point [Hb142], set the proportion of the frequency at that point to the base frequency [Hb104] (= 100%).
- This function works in V/f control (constant torque characteristics), V/f control (reducing torque characteristics), and free V/f control. ([AA121]=00,01,02,04,05,06)

e.g.) When [Hb140] = 02, the boost works only for the forward revolution of the motor.

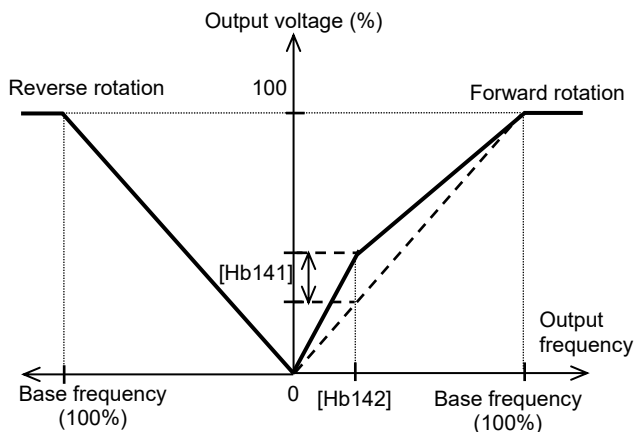

■ Parameters.

Name	Code	Data range (unit)	Description
Manual torque boost operation mode selection, 1st-motor	[Hb140]	00	Disabled
		01	Always enabled
		02	Enable at Forward rotation
		03	Enable at Reverse rotation
Manual torque boost value, 1st-motor	[Hb141]	0.0 to 20.0(%)	Sets the torque boost amount at the break point as the ratio to the motor rated voltage [Hb106].
Manual torque boost peak speed, 1st-motor	[Hb142]	0.0 to 50.0(%)	Sets, as the break point frequency, the value as the ratio to the base frequency [Hb104].

12.9.8 Stabilize Motor Revolution

Q

- To improve the unstable state of the motor caused by the vibration that occurs at a certain frequency or higher.

A

- This is a function to adjust the motor that is hunting to achieve a stable state. Search a set range for a point where the hunting stops, and make an adjustment accordingly.
- When a single inverter drives multiple motors, setting the stability constant at 0 may improve the state.
- When a load with large inertia such as a fan is rotated, decrementing the stability constant [HA110] by 10% each time may improve the state.
- When the motor capacity is smaller than the rated capacity of the inverter, incrementing the set value by 10% each time may improve the state. In contrast, when the motor capacity is larger than the rated capacity of the inverter, decrementing the set value by 10% each time may improve the state.



- If the motor is hunting and vibrating, check if appropriate settings are provided for the motor capacity, the number of motor poles, the base frequency, the rated voltage, and the rated current.
- Then perform the auto-tuning to check if the hunting is settled, and adjust the stability constant.
- Exemplar methods of reducing the hunting include the following methods:

1. Adjust the carrier frequency [bb101] by gradually decrementing it down to 2 kHz.
2. Adjust the output voltage gain [Hb180] by gradually decrementing it down to 80%.

If it is no effect, return the parameter setting value to the previous value.



Caution

- Do not perform a steady operation with a setting for the output voltage gain [Hb180] that exceeds 100%. The motor may be burned.

Parameters.

Name	Code	Data range (unit)	Description
Stabilization constant, 1st-motor	[HA110]	0 to 1000(%)	Adjust the control for reducing the hunting. This function works when the [AA121] = 00 to 07.
Output voltage gain, 1st-motor	[Hb180]	0 to 255(%)	Decrease it if the motor is hunting. A lower setting decreases the output voltage. This function works when the [AA121] = 00 to 07.
Carrier frequency setting, 1st-motor	[bb101]	0.5 to 16.0(kHz) *)	Change the carrier frequency of the PWM output. If the motor is hunting, lower the setting.

*) By models or settings may limit the carrier frequency. For details, see "12.12 Adjustments for Motor Electromagnetic Sound Noise, Electrical Noise, Heat Generation of Inverter".

12.9.9 Drive with Sensorless Vector Control

Q

- The motor has a slow response of frequency.
- More torque is needed.
- To use in applications that require a high torque at the start.
- To control the frequency accurately.
- To solve that the motor speed is slower than the frequency command at the heavy load.

A

- Sensorless vector control (SLV) automatically adjusts the output frequency and output voltage to control the motor, and by adjusting the response to the load to achieve highly accurate frequency output, and torque output with high response even low speeds.
- Even if a Hitachi's standard motor is used and/or the motor constant is directly set into as a parameter, it may be better to perform auto-tuning when the load inertia is huge or the length of wiring to the motor is long.
- Use of other motors than Hitachi's standard motors requires the setting-up of the motor constant and the load inertia by, for example performing the auto-tuning.

!

- In the sensorless vector control, set appropriately the motor capacity, the number of motor poles, the base frequency, the rated voltage, and the rated current in order to perform motor control.
- When the motor performs below its potential characteristics, perform the auto-tuning and make adjustment by referring to the next page.
- In the case of a long wiring (approximately longer than 20 m) and in the case of controlling another manufacturer motors, the performance may be below what are expected from the characteristics.
- In sensorless vector control, if the controlled motor capacity deviates from the applicable motor capacity for the inverter, sufficient operating characteristics cannot be obtained.
- In the sensorless vector control, adjustment of the response is possible. It is effective for the applications that require more following performance of the output frequency for the command.
- When a motor is hunting and vibrating, an adjustment of the [HA115] and [HC120] may improve the state of the motor.
- The control calculation may cause the output frequency to become negative near 0 speed and reverse rotate. In this case, the output direction can limit by enable the [HC114].
- By enabling [HC113], a slip changes due to temperature changes can be corrected. In this case, it is required to connect an external thermistor for motor temperature measurement to the TH+ / TH- terminals.

Parameters.

Name	Code	Data range (unit)	Description
Control mode selection, 1st-motor	[AA121]	08	To use the sensorless vector control (IM).
Speed response, 1st-motor	[HA115]	0 to 1000 (%)	To adjust the responsiveness of the control. A larger value enhances the responsiveness.
Boost value at start, 1st-motor (IM-SLV,IM-CLV)	[HC111]	0 to 50 (%)	To adjust the current command at the start when the starting torque is not sufficient.
Secondary resistance (R2) correction, 1st-motor	[HC113]	00	Disabled
		01	Enabled. Requiring a temperature thermistor.
Direction reversal protection, 1st-motor	[HC114]	00	Disabled
		01	Enabled. Limit the output to prevent the output in the reverse direction.
Torque current reference filter time constant, 1st-motor	[HC120]	0 to 100 (ms)	To adjust the filter for the torque current.
Speed feedforward compensation gain, 1st-motor	[HC121]	0 to 1000 (%)	To adjust the feed forward control of the speed controller.

Phenomenon▶	Estimated cause(s)▶	Exemplar measures to be taken
Shocks occur during the revolutions at the start.	<ul style="list-style-type: none"> The control system has a speed response that is too high. 	<ul style="list-style-type: none"> Make an adjustment by decrementing the Speed response [HA115] by 5% each time. Make an adjustment by decrementing the Async. Motor constant J [Hb118] by 5% each time. Make an adjustment by decrementing the Boost value at start [HC111] by 5% each time.
Unsteady revolutions at low speeds, resulting in fluctuating revolutions.	<ul style="list-style-type: none"> The control system has a speed response that is too low. 	<ul style="list-style-type: none"> Make an adjustment by incrementing the Speed response [HA115] by 5% each time. Make an adjustment by incrementing the IM motor constant J [Hb118] by 5% each time.
The motor is hunting.	<ul style="list-style-type: none"> The control system has a speed response that is too high. 	<ul style="list-style-type: none"> Make an adjustment by decrementing the Speed response [HA115] by 5% each time. Make an adjustment by decrementing the Async. Motor constant J [Hb118] by 5% each time.
When a load in the motor-stopping direction is applied to the motor, the revolution frequency becomes lower.	<ul style="list-style-type: none"> The motor constant R2 is set at too small a value. 	<ul style="list-style-type: none"> Make an adjustment by incrementing the current value of the Async. Motor constant R2 [Hb112] by 5% each time.
When a load in the motor-stopping direction is applied to the motor, the revolution frequency becomes higher.	<ul style="list-style-type: none"> The motor constant R2 is set at too large a value. 	<ul style="list-style-type: none"> Make an adjustment by decrementing the current value of the Async. Motor constant R2 [Hb112] by 5% each time.
When a load in the motor-rotating direction is applied to the motor at low speed, the revolution frequency becomes higher.	<ul style="list-style-type: none"> Insufficient regenerative torque at low speeds. 	<ul style="list-style-type: none"> Make an adjustment by incrementing the Async. Motor constant R1 [Hb110] by 5% of the current value each time. Make an adjustment by incrementing the Async. Motor constant I0 [Hb116] by 5% of the current value each time.
Revolution in the opposite direction to the command direction occurs for an instant.	<ul style="list-style-type: none"> A command demanding the revolution in the opposite direction is dispatched over the control system for an instant. 	<ul style="list-style-type: none"> Enable the Direction reversal protection [HC114].



- Set the carrier frequency [bb101] at a value of 2.0 kHz or higher. A set frequency of 1.9 kHz or lower may cause hunting.
- When the rotation of the motor is obstructed by the motor lock caused by the brake or foreign matter, the Overcurrent error or etc. will occur. Therefore, when the phenomenon cannot be improved by the adjustments described above, the cause may be found by checking the motor and its surroundings, and the situation may be improved.

- If an application of load results in a great amount of change in output frequency monitor [dA-01], the function which automatically changes the output frequency may be work. For example the overload limiting function, the instantaneous power failure non-stop function, the over voltage suppression function, and others. For details, see "Chapter 18 Tips/FAQ/Troubleshooting".

12.9.10 Drive with Zero-Hz Range Sensorless Vector Control

Q

- To use in applications, such as cranes, that require a high torque at the start.
- To accurately control the frequency.

A

- Zero-Hz range sensorless vector control automatically adjusts the frequency and output voltage so that torque output with high response is possible even at low speeds.
- In the Zero-Hz range sensorless vector control, the sensorless vector control is supplemented with an output that can achieve an intended torque from at extremely low speeds such as those in the Zero-Hz range.
- Even in the case of Hitachi's standard motors, a large load inertia and/or a long wiring may require the auto-tuning.
- Use of other motors than Hitachi's standard motors requires the setting-up of the motor constant and the load inertia by the auto-tuning or etc.
- As in the case of the sensorless vector control, acquire the motor constant by means of auto-tuning or the like.

!

- In the Zero-Hz range sensorless vector control, as in the case of the sensorless vector control, set appropriately the motor capacity, the number of motor poles, the base frequency, the rated voltage, and the rated current in order to perform motor control.
- When the motor performs below its potential characteristics, perform the auto-tuning and make adjustment by referring to the next page.
- In the case of a long wiring (approximately longer than 20 m) and in the case of controlling another manufacturer motors, the performance may be below what are expected from the characteristics.
- In the Zero-Hz range sensorless vector control, if the controlled motor capacity deviates from the applicable motor capacity for the inverter, sufficient operating characteristics cannot be obtained.
- In the Zero-Hz range sensorless vector control, as in the case of the sensorless vector control, adjustment of the response is possible. In addition to the adjustment of the response, it is possible to set the torque boost for the current at the start.
- When a motor is hunting and vibrating, an adjustment of the [HA115] and [HC120] may improve the state of the motor.
- The control calculation may cause the output frequency to become negative near 0 speed and reverse rotate. In this case, the output direction can limit by enable the [HC114].
- By enabling [HC113], a slip changes due to temperature changes can be corrected. In this case, it is required to connect an external thermistor for motor temperature measurement to the TH+ / TH- terminals.

Parameters.

Name	Code	Data range (unit)	Description
Control mode selection, 1st-motor	[AA121]	09	To use the Zero-Hz range sensorless vector control (IM) function.
Speed response, 1st-motor	[HA115]	0 to 1000(%)	To adjust the responsiveness of the control. A larger value enhances the responsiveness.
Zero speed range limiter, 1st-motor (IM-0Hz-SLV)	[HC110]	0 to 100(%)	To limit the current at the start so as not to allow the rising of the current to rise too high.
Boost value at start, 1st-motor (IM-0Hz-SLV)	[HC112]	0 to 50(%)	To adjust the current command at the start when the starting torque is not sufficient.
Secondary resistance (R2) correction, 1st-motor	[HC113]	00	Disabled
		01	Enabled. Requiring a temperature thermistor.
Direction reversal protection, 1st-motor	[HC114]	00	Disabled
		01	Enabled. Limit the output to prevent the output in the reverse direction.
Torque current reference filter time constant, 1st-motor	[HC120]	0 to 100(ms)	To adjust the filter for the torque current.
Speed feedforward compensation gain, 1st-motor	[HC121]	0 to 1000(%)	To adjust the feed forward control of the speed controller.

- In addition to the adjustment of the sensorless vector control, refer to the following description.

Phenomenon▶	Estimated cause(s)▶	Exemplar measures to be taken
Shocks occur during the revolutions at the start. Over current occurs at the start.	<ul style="list-style-type: none"> • Boost amount is too large. 	<ul style="list-style-type: none"> • Make an adjustment by decrementing the Zero speed range limiter [HC110] by 5% each time. • Make an adjustment by decrementing the Boost value at start [HC112] by 5% each time.
The motor cannot provide enough torque for the load is too high for the motor to at the start. Acceleration is not possible.	<ul style="list-style-type: none"> • Boost amount is too small. 	<ul style="list-style-type: none"> • Make an adjustment by incrementing the Boost value at start [HC112] by 5% each time.



- Set the carrier frequency [bb101] at a value of 2.0 kHz or higher. A set frequency of 1.9 kHz or lower may cause hunting.
- When the rotation of the motor is obstructed by the motor lock caused by the brake or foreign matter, the Overcurrent error or etc. will occur. Therefore, when the phenomenon cannot be improved by the adjustments described above, the cause may be found by checking the motor and its surroundings, and the situation may be improved.
- If an application of load results in a great amount of change in output frequency monitor [dA-01], the function which automatically changes the output frequency may be work. For example the overload limiting function, the instantaneous power failure non-stop function, the over voltage suppression function, and others. For details, see "Chapter 18 Tips/FAQ/Troubleshooting".

12.9.11 Drive with V/f Control with Encoder
(Constant Torque Characteristics)

Q

- I want to perform a V/f control with a high revolution accuracy by using the revolution-speed feedback of a motor.
- I want the output frequency to follow the frequency reference with high accuracy in order to calculate the number of turns of the winding machine or etc.

!

- When [CA-90] = 02, Input terminals [A] and [B] are switched to the terminals for feedback control. When [CA-90] ≠ 02, terminals [EA] and [EB] of the feedback option P1-FB are enabled. See "12.9.17 Use Encoder."

A

- The feedback of the encoder signal from the motor allows highly accurate frequency control.
- For the adjustment of V/f control (constant torque characteristics), see "12.9.2 Drive with V/f Control (Constant Torque Characteristics)."
- In the V/f control with encoder, as shown below, the output is corrected by PI control at the feedback frequency and the command frequency and the motor is controlled.

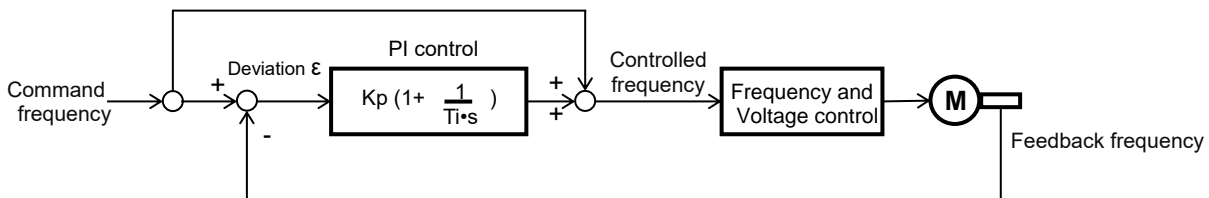

Kp: proportional gain setting; Ti: integral time; s: operator; ε: deviation
Ki: integral gain setting (Ki = Kp/Ti)

Parameters.

Name	Code	Data range (unit)	Description
Control mode selection, 1st-motor	[AA121]	04	To use V/f control with encoder (constant torque characteristics).
Slip compensation P-gain at V/f with encoder, 1st-motor	[Hb170]	0 to 1000(%)	This is the P gain for the slip compensation of control with sensor.
Slip compensation I-gain at V/f with encoder, 1st-motor	[Hb171]	0 to 1000(%)	This is the I gain for the slip compensation of control with sensor.



- Please refer to the following in addition to the notes for each control mode.

Phenomenon▶	Estimated cause(s)▶	Exemplar measures to be taken
<ul style="list-style-type: none"> • The motor speed follows the command frequency slowly. 	<ul style="list-style-type: none"> • Since the output response is slow, following of motor speed (feedback value) becomes slow. 	<ul style="list-style-type: none"> • Increment the proportional (P) gain [Hb170].
<ul style="list-style-type: none"> • The motor operates unstably. • Overshoot and/or hunting occur. 	<ul style="list-style-type: none"> • Since the control response is too high. 	<ul style="list-style-type: none"> • Decrement the proportional (P) gain [Hb170].
<ul style="list-style-type: none"> • The motor speed vibrates gently. • To reach the command frequency and stabilize the operation requires a long time. 	<ul style="list-style-type: none"> • Since the integral control response is too low. 	<ul style="list-style-type: none"> • Increment the integral (I) gain [Hb171].
<ul style="list-style-type: none"> • The motor speed vibrates and does not easily match the command frequency. 	<ul style="list-style-type: none"> • Since the integral control response is too high. 	<ul style="list-style-type: none"> • Decrement the integral (I) gain [Hb171].



- When the rotation of the motor is obstructed by the motor lock caused by the brake or foreign matter, the Overcurrent error or etc. will occur. Therefore, when the phenomenon cannot be improved by the adjustments described above, the cause may be found by checking the motor and its surroundings, and the situation may be improved.

- If an application of load results in a great amount of change in output frequency monitor [dA-01], the function which automatically changes the output frequency may be work. For example the overload limiting function, the instantaneous power failure non-stop function, the over voltage suppression function, and others. For details, see "Chapter 18 Tips/FAQ/Troubleshooting".

12.9.12 Drive with V/f control with Encoder
(Reducing Torque Characteristics)

Q

- To perform a V/f control with a high revolution accuracy by use of the revolution-speed feedback of a motor.
- To output the revolutions of fans and/or pumps exactly in accordance with their respective speed characteristics.

!

- When [CA-90] = 02, Input terminals [A] and [B] are switched to the terminals for feedback control. When [CA-90] ≠ 02, terminals [EA] and [EB] of the feedback option P1-FB are enabled. See "12.9.17 Use Encoder."

A

- The feedback of the encoder signal from the motor allows highly accurate frequency control.
- For the adjustment of V/f control (reducing torque characteristics), see "12.9.3 Drive with V/f Control (Reducing Torque Characteristics)."
- In the V/f control with encoder, as shown below, the output is corrected by PI control at the feedback frequency and the command frequency and the motor is controlled as shown below.

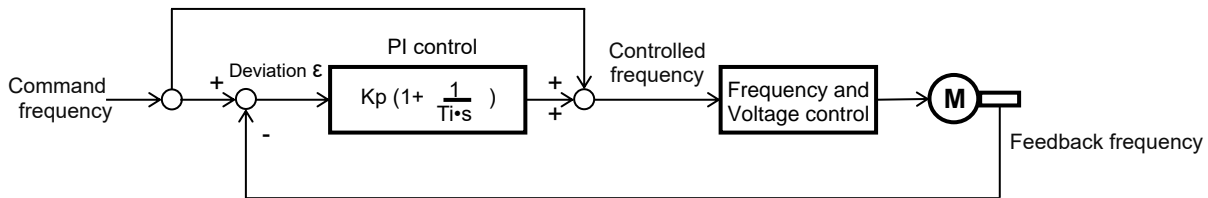

Kp: proportional gain setting; Ti: integral time; s: operator; ε: deviation
Ki: integral gain setting (Ki = Kp/Ti)

Parameters.

Name	Code	Data range (unit)	Description
Control mode selection, 1st-motor	[AA121]	05	To use V/f control with sensor (reducing torque characteristics).
Slip compensation P-gain at V/f with encoder, 1st-motor	[Hb170]	0 to 1000(%)	This is the P gain for the slip compensation of control with sensor.
Slip compensation I-gain at V/f with encoder, 1st-motor	[Hb171]	0 to 1000(%)	This is the I gain for the slip compensation of control with sensor.



- Please refer to the following in addition to the notes for each control mode.

Phenomenon▶	Estimated cause(s)▶	Exemplar measures to be taken
<ul style="list-style-type: none"> • The motor speed follows the command frequency slowly. 	<ul style="list-style-type: none"> • Since the output response is slow, following of motor speed (feedback value) becomes slow. 	<ul style="list-style-type: none"> • Increment the proportional (P) gain [Hb170].
<ul style="list-style-type: none"> • The motor operates unstably. 	<ul style="list-style-type: none"> • Since the control response is too high. 	<ul style="list-style-type: none"> • Decrement the proportional (P) gain [Hb170].
<ul style="list-style-type: none"> • Overshoot and/or hunting occur. 		
<ul style="list-style-type: none"> • The motor speed vibrates gently. 	<ul style="list-style-type: none"> • Since the integral control response is too low. 	<ul style="list-style-type: none"> • Increment the integral (I) gain [Hb171].
<ul style="list-style-type: none"> • To reach the command frequency and stabilize the operation requires a long time. 		
<ul style="list-style-type: none"> • The motor speed vibrates and does not easily match the command frequency. 	<ul style="list-style-type: none"> • Since the integral control response is too high. 	<ul style="list-style-type: none"> • Decrement the integral (I) gain [Hb171].



- When the rotation of the motor is obstructed by the motor lock caused by the brake or foreign matter, the Overcurrent error or etc. will occur. Therefore, when the phenomenon cannot be improved by the adjustments described above, the cause may be found by checking the motor and its surroundings, and the situation may be improved.

- If an application of load results in a great amount of change in output frequency monitor [dA-01], the function which automatically changes the output frequency may be work. For example the overload limiting function, the instantaneous power failure non-stop function, the over voltage suppression function, and others. For details, see "Chapter 18 Tips/FAQ/Troubleshooting".

12.9.13 Drive with Free V/f Control with Encoder

Q

- To perform a V/f control with a high revolution accuracy by use of the revolution-speed feedback of a motor.
- To control the speed of high-speed motors



- When [CA-90] = 02, Input terminals [A] and [B] are switched to the terminals for feedback control. When [CA-90] ≠ 02, terminals [EA] and [EB] of the feedback option P1-FB are enabled. See "12.9.17 Use Encoder."

A

- The feedback of the encoder signal from the motor allows highly accurate frequency control.
- For the adjustment of V/f control (free V/f), see "12.9.4 Drive with Free V/f Control".
- In the V/f control with encoder, as shown below, the output is corrected by PI control at the feedback frequency and the command frequency and the motor is controlled.

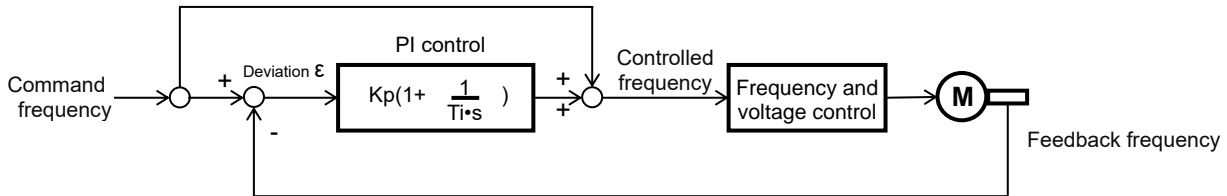

Kp: proportional gain setting; Ti: integral time; s: operator; ε: deviation
 Ki: integral gain setting (Ki = Kp/Ti)

Parameters.

Name	Code	Data range (unit)	Description
Control mode selection, 1st-motor	[AA121]	06	To use V/f control with sensor (free V/f).
Slip compensation P-gain at V/f with encoder, 1st-motor	[Hb170]	0 to 1000(%)	This is the P gain for the slip compensation of control with sensor.
Slip compensation I-gain at V/f with encoder, 1st-motor	[Hb171]	0 to 1000(%)	This is the I gain for the slip compensation of control with sensor.



- Please refer to the following in addition to the notes for each control mode.

Phenomenon▶	Estimated cause(s)▶	Exemplar measures to be taken
<ul style="list-style-type: none"> • The motor speed follows the command frequency slowly. 	<ul style="list-style-type: none"> • Since the output response is slow, following of motor speed (feedback value) becomes slow. 	<ul style="list-style-type: none"> • Increment the proportional (P) gain [Hb170].
<ul style="list-style-type: none"> • The motor operates unstably. 	<ul style="list-style-type: none"> • Since the control response is too high. 	<ul style="list-style-type: none"> • Decrement the proportional (P) gain [Hb170].
<ul style="list-style-type: none"> • Overshoot and/or hunting occur. 		
<ul style="list-style-type: none"> • The motor speed vibrates gently. 	<ul style="list-style-type: none"> • Since the integral control response is too low. 	<ul style="list-style-type: none"> • Increment the integral (I) gain [Hb171].
<ul style="list-style-type: none"> • To reach the command frequency and stabilize the operation requires a long time. 		
<ul style="list-style-type: none"> • The motor speed vibrates and does not easily match the command frequency. 	<ul style="list-style-type: none"> • Since the integral control response is too high. 	<ul style="list-style-type: none"> • Decrement the integral (I) gain [Hb171].



- When the rotation of the motor is obstructed by the motor lock caused by the brake or foreign matter, the Overcurrent error or etc. will occur. Therefore, when the phenomenon cannot be improved by the adjustments described above, the cause may be found by checking the motor and its surroundings, and the situation may be improved.
- If an application of load results in a great amount of change in output frequency monitor [dA-01], the function which automatically changes the output frequency may be work. For example the overload limiting function, the instantaneous power failure non-stop function, the over voltage suppression function, and others. For details, see "Chapter 18 Tips/FAQ/Troubleshooting".

12.9.14 Drive with Automatic Torque Boost Function with Encoder



- To perform a V/f control with a high revolution accuracy by use of the revolution-speed feedback of a motor.
- To make the motor follow the command frequency accurately in applications that require a certain torque.



- When [CA-90] = 02, Input terminals [A] and [B] are switched to the terminals for feedback control. When [CA-90] ≠ 02, terminals [EA] and [EB] of the feedback option P1-FB are enabled. See "12.9.17 Use Encoder."



- The feedback of the encoder signal from the motor allows highly accurate frequency control.
- For the adjustment of the automatic boost control, see, "12.9.5 Drive with Automatic Torque Boost Control".
- In the V/f control with encoder, as shown below, the output is corrected by PI control at the feedback frequency and the command frequency and the motor is controlled.

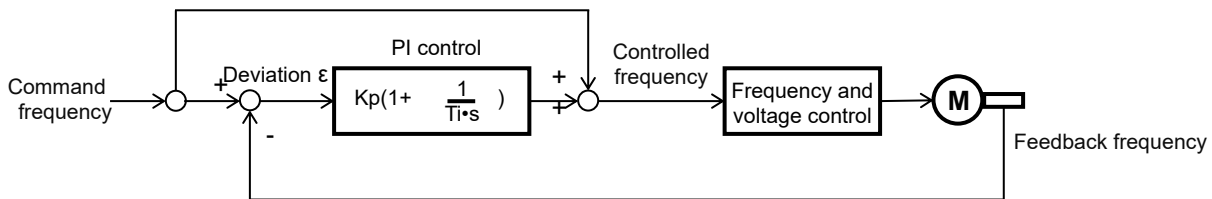

Kp: proportional gain setting; Ti: integral time; s: operator; ε: deviation
 Ki: integral gain setting (Ki = Kp/Ti)

■ Parameters.

Name	Code	Data range (unit)	Description
Control mode selection, 1st-motor	[AA121]	07	To use the automatic torque boost with sensor.
Slip compensation P-gain at V/f with encoder, 1st-motor	[Hb170]	0 to 1000(%)	This is the P gain for the slip compensation of control with sensor.
Slip compensation I-gain at V/f with encoder, 1st-motor	[Hb171]	0 to 1000(%)	This is the I gain for the slip compensation of control with sensor.



• Please refer to the following in addition to the notes for each control mode.

Phenomenon▶	Estimated cause(s)▶	Exemplar measures to be taken
<ul style="list-style-type: none"> • The motor speed follows the command frequency slowly. 	<ul style="list-style-type: none"> • Since the output response is slow, following of motor speed (feedback value) becomes slow. 	<ul style="list-style-type: none"> • Increment the proportional (P) gain [Hb170].
<ul style="list-style-type: none"> • The motor operates unstably. 	<ul style="list-style-type: none"> • Since the control response is too high. 	<ul style="list-style-type: none"> • Decrement the proportional (P) gain [Hb170].
<ul style="list-style-type: none"> • Overshoot and/or hunting occur. 		
<ul style="list-style-type: none"> • The motor speed vibrates gently. 	<ul style="list-style-type: none"> • Since the integral control response is too low. 	<ul style="list-style-type: none"> • Increment the integral (I) gain [Hb171].
<ul style="list-style-type: none"> • To reach the command frequency and stabilize the operation requires a long time. 		
<ul style="list-style-type: none"> • The motor speed vibrates and does not easily match the command frequency. 	<ul style="list-style-type: none"> • Since the integral control response is too high. 	<ul style="list-style-type: none"> • Decrement the integral (I) gain [Hb171].



• When the rotation of the motor is obstructed by the motor lock caused by the brake or foreign matter, the Overcurrent error or etc. will occur. Therefore, when the phenomenon cannot be improved by the adjustments described above, the cause may be found by checking the motor and its surroundings, and the situation may be improved.

• If an application of load results in a great amount of change in output frequency monitor [dA-01], the function which automatically changes the output frequency may be work. For example the overload limiting function, the instantaneous power failure non-stop function, the over voltage suppression function, and others. For details, see "Chapter 18 Tips/FAQ/Troubleshooting".

12.9.15 Drive with Vector Control with Encoder



- To perform highly accurate control on the motor with encoder feedback.
- To use the position control function.



- The feedback of the encoder signal from the motor allows highly accurate frequency control from the low-speed range.
- In the vector control with sensor, to control the motor, the frequency and the output voltage are corrected and the response is adjusted with respect to the load inertia. Accordingly, it requires the acquisition of the motor constant and the load inertia by means of auto-tuning or the like.
- In the vector control with sensor, adjustment of the response is possible. The vector control with sensor can be used in applications that require a better follow-up performance of the speed to the command.
- In the vector control with sensor, the position control mode can be used.
- Even in the case of Hitachi's standard motors, a large load inertia and/or a long wiring may require the auto-tuning.
- Use of other motors than Hitachi's standard motors requires the setting-up of the motor constant and the load inertia by, for example perform the auto-tuning.
- When a motor is hunting and vibrating, an adjustment of the [HA115] and [HC120] may improve the state of the motor.



- Conducting the vector control with encoder requires the encoder feedback from the motor.
- When [CA-90] = 02, Input terminals [A] and [B] are switched to the terminals for feedback control. When [CA-90] ≠ 02, terminals [EAP], [EBP], [EAN], and [EBN] of the feedback option P1-FB are enabled. See "12.9.17 Use Encoder."
- In the vector control with encoder, set appropriately the motor capacity, the number of motor poles, the base frequency, the rated voltage, and the rated current in order to perform motor control.
- If the controlled motor capacity becomes smaller and smaller from the applicable motor capacity for the inverter, sufficient operating characteristics cannot be obtained.
- In the case of a long wiring (approximately longer than 20 m) and in the case of controlling another manufacturer motors, the performance may be below what are expected from the characteristics.
- The control calculation may cause the output frequency to become negative near 0 speed and reverse rotate. In this case, the output direction can limit by enable the [HC114].
- By enabling [HC113], a slip changes due to temperature changes can be corrected. In this case, it is required to connect an external thermistor for motor temperature measurement to the TH+ / TH- terminals.

■ Parameters.

Name	Code	Data range (unit)	Description
Control mode selection, 1st-motor	[AA121]	10	To use the vector control with sensor (IM).
Speed response, 1st-motor	[HA115]	0 to 1000(%)	To adjust the responsiveness of the control. A larger value enhances the responsiveness.
Vector control mode selection, 1st-motor	[AA123]	00	Operation is possible by switching between the speed control and the torque control.
		01	Activate the pulse train position control mode.
		02	Activate the absolute position control mode.
		03	Activate the high-resolution absolute position control mode.
Boost value at start, 1st-motor (IM-SLV,IM-CLV)	[HC111]	0 to 50(%)	To adjust the current command at the start when the starting torque is not sufficient.
Secondary resistance (R2) correction, 1st-motor	[HC113]	00	Disabled
		01	Enabled. Requiring a temperature thermistor.
Direction reversal protection, 1st-motor	[HC114]	00	Disabled
		01	Enabled. Limit the output to prevent the output in the reverse direction.
Torque current reference filter time constant, 1st-motor	[HC120]	0 to 100(ms)	To adjust the filter for the torque current.
Speed feedforward compensation gain, 1st-motor	[HC121]	0 to 1000(%)	To adjust the feed forward control of the speed controller.

Phenomenon▶	Estimated cause(s)▶	Exemplar measures to be taken
The performance is not sufficient for what the motor control characteristics predict.	<ul style="list-style-type: none"> An improper motor constant is being used. 	<ul style="list-style-type: none"> The performance may be improved by auto-tuning. Check "12.3.3 Auto-Tuning of Motor".
Shocks occur during the revolutions at the start.	<ul style="list-style-type: none"> The control system has a frequency response that is too high. 	<ul style="list-style-type: none"> Make an adjustment by decrementing the Speed response [HA115] by 5% each time. Make an adjustment by decrementing the Async. Motor constant J [Hb118] by 5% each time.
The motor is hunting.	<ul style="list-style-type: none"> The control system has a frequency response that is too low. 	<ul style="list-style-type: none"> Make an adjustment by incrementing the Speed response [HA115] by 5% each time. Make an adjustment by incrementing the Async. Motor constant J [Hb118] by 5% each time.
Unsteady revolutions at low speeds, resulting in fluctuating revolutions.	<ul style="list-style-type: none"> The control system has a frequency response that is too low. 	<ul style="list-style-type: none"> Make an adjustment by incrementing the Speed response [HA115] by 5% each time. Make an adjustment by incrementing the Async. Motor constant J [Hb118] by 5% each time.
Normal acceleration is impossible and the protection against the over load works.	<ul style="list-style-type: none"> An improper motor constant is being used. 	<ul style="list-style-type: none"> The performance may be improved by auto-tuning. Check "12.3.3 Auto-Tuning of Motor".
	<ul style="list-style-type: none"> An improper phase sequence is being used. 	<ul style="list-style-type: none"> Set V/f control (00) in [AA121], and check the Detect speed monitor [dA-08]. The wiring is correct if the forward [FW] has a positive (+) value and if the reverse [RV] has a negative (-) value. If the forward and reverse RUN command have incorrect values, rearrange the phase sequence in the encoder or check again, "12.9.17 Use Encoder."



- Set the carrier frequency [bb101] at a value of 2.0 kHz or higher. A set frequency of 1.9 kHz or lower may cause an incorrect operation.
- When the rotation of the motor is obstructed by the motor lock caused by the brake or foreign matter, the Overcurrent error or etc. will occur. Therefore, when the phenomenon cannot be improved by the adjustments described above, the cause may be found by checking the motor and its surroundings, and the situation may be improved.
- If an application of load results in a great amount of change in output frequency monitor [dA-01], the function which automatically changes the output frequency may be work. For example the overload limiting function, the instantaneous power failure non-stop function, the over voltage suppression function, and others. For details, see "Chapter 18 Tips/FAQ/Troubleshooting".

12.9.16 Control Synchronous Motor (Permanent Magnet Motor).

Q

- I want to use the synchronous motor (permanent magnet motor) for saving energy.
- I want to replace the replace an induction motor with a synchronous motor (permanent magnet motor).

■ Precautions for the synchronous motor (permanent magnet motor) control

!

- Set an appropriate the Overcurrent detection level [bb160]. Do not drive a motor whose maximum current (demagnetization level) is below the 150% of [bb160].
 - * Be aware of the root-mean-square value and the peak value. The rated output current listed in the specification table is the root-mean-square value.
- This is the control mode for the reducing torque applications where the motor that has the same frame number as the inverter's rating needs a torque at the start that is 50% or smaller. If higher starting torque is necessary, please contact our sales office.
- This mode can be used neither in applications that require a constant torque from low speeds nor in applications that involve rapid acceleration or deceleration and that require a large torque from low speeds. Never use this mode for applications involving a gravity load, such as lifts.
- Synchronous motors (permanent magnet motors) cannot be operated by a direct input from the commercial power supply.
- Multiple synchronous motors (permanent magnet motors) cannot be driven by a single inverter.
- Synchronous motors (permanent magnet motors) are more likely to cause over voltage errors than non-synchronous motors (induction motors). For applications that require rapid deceleration, consider using the optional braking resistor or external regenerative braking unit.
- When a hold brake is used, release the brake before the motor starts operation. Otherwise, the motor may lose its synchronism.
- The motor may move in the reverse direction at the start of its revolution. When a malfunction is caused by the reverse revolution, set the Starting method for Sync.M [Hd132] to 01(Initial motor position estimation (IMPE)).
- It is recommended to set the carrier frequency [bb101] to 8.0kHz or higher. If the carrier frequency is low, the motor heat may increase. Please contact the motor manufacturer for details.
- The tolerable load moment of inertia is 50 times as large as the motor's moment of inertia or smaller. Some applications whose loads moment of inertia exceed the above mentioned range may result in a performance that is below the desired one.
- In the case of a long wiring (approximately longer than 20 m) and in the case of controlling another manufacturer motors, the performance may be below what are expected from the characteristics.
- In the case of a long wiring (approximately longer than 20 m), frequency matching restart function may cause an over current error.
- Driving a motor that the Sync. Motor rated current [Hd108] exceeds the inverter's rated current or a motor whose using motor size is smaller than the applicable motor for the inverter by 2 size or more may result in a performance that is below the desirable one.
- Set not only the Sync. Motor rated current [Hd108] but also the Electronic thermal level setting [bC110].
- If the initial motor position estimation is enabled in the Starting method for Sync. M [Hd132], a shrill sound caused by the position detection action may be heard, but this sound has nothing to do with any abnormality.
- If the initial motor position estimation is enabled in the Starting method for Sync. M [Hd132], start the operation from the state in which the motor stopped. Otherwise a failure to acquire the correct position may occur, which may result in unintended revolution, over current, or loss of synchronization.

A

- Controlling a synchronous motor (permanent magnet motor) requires the setting-up of the motor constant. See, "12.3 Basic Settings of Motor" The motor constant is data corresponding to one phase of Y-connection (including wiring).

■ Disabled functions with SM(PMM) mode.



- The following functions cannot be used when the synchronous motor (permanent magnet motor) control is selected.
- Even when they are enabled by setting of parameters, they are actually disabled.
- In the following table, only the common settings (parameter center "-") and the first settings (parameter center "1") are listed, but it is not possible either to use the second settings (parameter center "2").

■ Parameters that are invalid during synchronous motor (permanent magnet motor) control.

Item	Parameter	Description
Functions associated with torque control	[FA-15], [FA-16], [dA-15], and [dA-16]	Torque command monitor function
	[Ad-01] to [Ad-04], and [Ad-40] to [Ad-42], Input terminal 067 [ATR]	Torque control function
	[Ad-11] to [Ad-14], Input terminal 068 [TBS]	Torque bias function
	[bA110] to [bA116], and [bA210] to [bA216], Input terminals 060 [TL], 061 [TRQ1], and 062 [TRQ2], Output terminal 022 [TRQ]	Torque limit function
	[CE120] to [CE123], Output terminal 019 [OTQ]	Over torque signal
Over current suppression function	[bA120] and [bA121]	Over current suppression function
Functions associated with induction motor control	[HA110]	Stabilization adjustment gain
	[Hb130], [Hb131], [Hb140] to [Hb142], [Hb145], [Hb146], [Hb150] to [Hb163], [Hb170], [Hb171], and [Hb180]	Functions associated with V/f control
	[HC101] and [HC102]	Functions associated with automatic torque boost
	[HC110] to [HC115], [HC120], and [HC121]	Sensorless vector control, Zero-Hz range sensorless vector control, Vector control with encoder
Part of gain mapping function	[HA126],[HA129],[HA132],[HA134]	Constant for Integral control
Part of auto-tuning	[HA-01]=02	Rotating system tuning
	[HA-03]	Online auto-tuning
Commercial power supply switching function	Input terminal 035 [CS]	Switching to commercial power supply
Acceleration or deceleration cancellation function	Input terminal 071 [LAC]	Acceleration or deceleration cancellation function
Jogging Operation	[AG-20], [AG-21], Input Terminals029[JG]	Jogging Operation Function

■ Control operation in synchronous start mode.

A

- In this control mode, operation is switched in the order of magnetic-pole position estimation, synchronous start control, and sensorless vector control.
- In the magnetic-pole position estimation, it is possible to select whether the motor is started after the motor's magnetic-pole positions are estimated by use of the initial motor position estimation (IMPE) function or the magnetic-pole positions are synchronized by use of the DC braking function.
- In the case of starting after the magnetic-pole position estimation, estimation operation is performed at the start by setting the start method [Hd132] at 01.
- In the case of the start method [Hd132] being set at 00, the motor is started as its magnetic poles are synchronized with the output phases. In the case where the magnetic poles and the output phases are unsynchronized by a great amount, or in the case that require a certain starting torque, use the DC braking force at start to synchronize the magnetic-pole positions and the output phases before the acceleration.
- Use [AF108] to adjust the current during a synchronous starting. Adjustment is possible even when [AF101] = 00. When a larger torque is needed than what is needed in the synchronous starting mode, use of IVMS start mode may improve the situation. Please contact our sales officer.
- The frequency at which the synchronous start control is switched to the sensorless vector control is adjusted by the Minimum frequency adjustment for Sync.M [Hd130].
- When a motor is hunting and vibrating, an adjustment of the speed response [HA115] and/or the no-load current [Hd131] may improve the state of the motor.
- When the DC braking force at start function is used at the start, see "12.14.2 Starting with DC Braking".

■ Parameters for synchronous start mode.

Name	Code	Data range (unit)	Description
Control mode selection, 1st-motor	[AA121]	11	To use synchronous-start type sensorless vector control (SM/PMM)
Speed response, 1st-motor	[HA115]	0 to 1000(%)	To adjust the responsiveness of the control. A larger value enhances the responsiveness.
Minimum frequency adjustment for Sync.M, 1st-motor	[Hd130]	0 to 50(%)	At the frequency of [Hd130] × base frequency [Hd104], synchronous start control or IVMS start control is switched to sensorless control. By this setting, there is no effect on the frequency command like the [Hb103] Minimum frequency for IM.
No-Load current for Sync.M, 1st-motor	[Hd131]	0 to 100(%)	Set the ratio of the no-load current to the rated current during the sensorless vector control.
Starting method for Sync.M, 1st-motor	[Hd132]	00	Initial motor position estimation (IMPE) is disabled.
		01	Initial motor position estimate (IMPE) is enabled.
IMPE 0V wait number for Sync.M, 1st-motor	[Hd133]	0 to 255	This is a stand-by adjustment value to stabilize the reference value for the IMPE detection.
IMPE detect wait number for Sync.M, 1st-motor	[Hd134]	0 to 255	This is an adjustment value to stabilize the current rise of the IMPE operation.
IMPE detect number for Sync.M, 1st-motor	[Hd135]	0 to 255	This is a detection-operation adjustment value of the IMPE operation.
IMPE voltage gain for Sync.M, 1st-motor	[Hd136]	0 to 200(%)	This is a output-voltage adjustment gain of the IMPE operation.
IMPE Mg-pole position offset, 1st-motor	[Hd137]	0 to 359°	To perform corrections in a case where the IMPE operation has a certain error.
DC braking selection, 1st-motor	[AF101]	01	Internal DC braking: enabled
DC braking force at start, 1st-motor	[AF108]	0 to 100(%)	To adjust the DC braking force. Setting of 100% will provide maximum braking force.
DC braking active time at start, 1st-motor	[AF109]	0.0 to 60.0(s)	Enabled during the internal DC braking. When the operation command is turned ON, DC braking is started.
Overcurrent detection level, 1st-motor	[bb160]	Inverter ND rated current × (0.2 to 2.2)	To Set the level at which the over current is detected.

Phenomenon▶	Estimated cause(s)▶	Exemplar measures to be taken
At the start, rotating temporarily in the opposite direction to the intended one.	<ul style="list-style-type: none"> Misalignment of the output phases and the motor's magnetic-pole positions. 	<ul style="list-style-type: none"> Enable the initial motor position estimation. [Hd132]=01. In the cases of a slight opposite-direction movement even in the initial motor position estimation function, make an adjustment by incrementing [Hd137] by 5° at a time.
Over current occurs at the start.	<ul style="list-style-type: none"> Insufficient starting torque. Misalignment of the output phases and the motor's magnetic-pole positions. 	<ul style="list-style-type: none"> Enable the initial motor position estimation. [Hd132]=01. Set the DC braking at the start [AF101] = 01, and after the start, the time needed for the motor to be stabilized is set in [AF109]. In addition, make an adjustment by incrementing the DC braking force at start [AF108] by 5% each time.
At the start, the motor loses synchronization and no acceleration.	<ul style="list-style-type: none"> Insufficient starting torque. Misalignment of the output phases and the motor's magnetic-pole positions. 	<ul style="list-style-type: none"> Enable the initial motor position estimation. [Hd132]=01. Set the DC braking at the start [AF101] = 01, and after the start, the time needed for the motor to be stabilized is set in [AF109]. In addition, make an adjustment by incrementing the DC braking force at start [AF108] by 5% each time.
A long starting time is required.	<ul style="list-style-type: none"> A long phase-synchronization time is required. 	<ul style="list-style-type: none"> When the magnetic-pole positions are synchronized in the DC braking at the starting, enable the initial motor position estimation instead of the DC braking at the start. [Hd132]=01.
Fluctuating revolutions occur at low speeds ([Hd130] minimum frequency or even lower).	<ul style="list-style-type: none"> Insufficient starting torque. 	<ul style="list-style-type: none"> Make an adjustment by incrementing the DC braking force at start [AF108] by 5% each time.
Hunting occurs at low speeds ([Hd130] minimum frequency or even lower).	<ul style="list-style-type: none"> There is a setting mismatch in motor constants. 	<ul style="list-style-type: none"> Decrement the motor constant R [Hd110] little by little until it reaches a value = set value × 0.7. Increment little by little each of the motor constant Ld [Hd112] and the motor constant Lq [Hd114] until they reach their respective values = set values × 1.4. Note, however that Ld ≤ Lq.
Shock or overcurrent occurs at about the [Hd130] minimum frequency.	<ul style="list-style-type: none"> The speed response is too low. Fluctuations occur near the frequency at which control is switched. 	<ul style="list-style-type: none"> Make an adjustment by incrementing the speed response [HA115] by 5% each time. Adjust the Minimum frequency adjustment for Sync.M [Hd130].
Hunting occurs at higher speeds (at the [Hd130] minimum frequency or higher).	<ul style="list-style-type: none"> Unsynchronized speed response. Distorted wave form of the current wave. 	<ul style="list-style-type: none"> Make an adjustment by incrementing/decrementing the speed response [HA115] by 5% each time. Make an adjustment by incrementing No-Load current for Sync.M [Hd131] by 5% each time.
A long initial motor position estimation time is required.	<ul style="list-style-type: none"> Set value for the estimation is too large. 	<ul style="list-style-type: none"> Lower the values [Hd133] to [Hd135] by the same ratio. * Too low a value may result in an operation in the opposite direction.
A movement in the opposite direction occurs while the initial motor position estimation is being used.	<ul style="list-style-type: none"> The estimation is improperly performed. 	<ul style="list-style-type: none"> Raise the values [Hd133] to [Hd135] by the same ratio, or raise the IMPE voltage gain for Sync.M [Hd136] by 5% each time.
While the initial motor position estimation is being used, overcurrent error occurred.	<ul style="list-style-type: none"> Voltage gain is too high. 	<ul style="list-style-type: none"> Decrement the IMPE voltage gain for Sync.M [Hd136] by 5% each time.
While the frequency matching restart function is used, an error occurred.	<ul style="list-style-type: none"> Too high revolution speeds and too large offset of the phases. 	<ul style="list-style-type: none"> Make an adjustment by incrementing the speed response [HA115] by 5% each time. Waiting a longer time for the re-start may improve the situation.



- When the rotation of the motor is obstructed by the motor lock caused by the brake or foreign matter, the Overcurrent error or etc. will occur. Therefore, when the phenomenon cannot be improved by the adjustments described above, the cause may be found by checking the motor and its surroundings, and the situation may be improved.

- If an application of load results in a great amount of change in output frequency monitor [dA-01], the function which automatically changes the output frequency may be work. For example the overload limiting function, the instantaneous power failure non-stop function, the over voltage suppression function, and others. For details, see "Chapter 18 Tips/FAQ/Troubleshooting".

■ Control operation in IVMS start mode.

A

- IVMS start mode is a start mode where larger torque is provided than in the synchronous starting mode.
- When the synchronous starting mode provides an insufficient torque, use of the IVMS start mode may improve the performance.
- Use of the IVMS start mode requires an SM(PMM) constant that is set by the sensorless vector control and an adjustment dedicated for IVMS start mode.
- Before the motor drive, perform an IVMS auto-tuning and a test run with the load removed.



- Some SM (PMM) may be unable to start in the IVMS start mode.
- IVMS start mode is a control mode that requires a strict adjustment. If your motor cannot start, please contact our sales office.
- IVMS start mode requires a re-adjustment when the inverter is replaced. When a malfunctioning inverter needs to be restored immediately by replacing the malfunctioning inverter with a new one, the synchronous starting mode should be used.
- As the IVMS start mode is a very special control, which may make a unique operation sound as the starting sound.

■ Parameters for IVMS start mode.

Name	Code	Data range (unit)	Description
IVMS carrier frequency	[Hd-41]	0.5 to 16.0 (kHz)	Set the carrier frequency for the IVMS drive.
Filter gain of IVMS current detection	[Hd-42]	0 to 1000	The filter adjustment gain applied to the detection current during the IVMS drive.
Open-phase voltage detection gain	[Hd-43]	00 to 03	The adjustment gain applied to the detection voltage during the IVMS drive.
Open-phase switching threshold compensation	[Hd-44]	00	IVMS correction: Disabled (no correction)
		01	IVMS correction: Enabled (correction to be performed)
SM(PMM)-IVMS speed control P gain	[Hd-45]	0 to 1000	Speed control P gain during the IVMS drive. A larger value enhances the responsiveness of the speed control.
SM(PMM)-IVMS speed control I gain	[Hd-46]	0 to 10000	Speed control Integral gain during the IVMS drive. A larger value enhances the responsiveness of the speed control.
SM(PMM)-IVMS wait time for open-phase switching,	[Hd-47]	0 to 1000	Waiting time for the open-phase switching during the IVMS drive. A larger value enhances the stability.
SM(PMM)-IVMS restriction on the rotation-direction determination	[Hd-48]	00	Rotation-direction determination: Disabled (no restriction)
		01	Rotation-direction determination: Enabled (restricted to the operation-command direction)
SM(PMM)-IVMS open-phase voltage detection timing adjustment	[Hd-49]	0 to 1000	Adjustment value of the IVMS detection timing.
SM(PMM)-IVMS minimum pulse width adjustment	[Hd-50]	0 to 1000	To adjust the width of the voltage pulse during the IVMS drive. A larger value renders the pulse width wider.
IVMS threshold current limit	[Hd-51]	0 to 255	Set a limit on each of the upper and the lower limits of the detection current during the IVMS drive. Enabled when [Hd-44] = 01 (enabled).
IVMS threshold gain	[Hd-52]	0 to 255	To adjust the IVMS auto-tuning value.
IVMS carrier-frequency switching start/finish point	[Hd-58]	0 to 50 (%)	To adjust the point where the carrier frequency is switched in the IVMS start mode.

A

- In this control mode, operations of magnetic-pole position estimation, IVMS start control, and sensorless vector control are started in this order.
- In this control mode, only the parameters set by the first set-up are enabled. Terminal [SET] cannot be used.
- In the magnetic-pole position estimation, it is possible to select whether the motor is started after the motor's magnetic-pole positions are estimated by use of the initial motor position estimation function or the magnetic-pole positions are synchronized by use of the DC braking force at start function.
- In the case of starting after the magnetic-pole position estimation, estimation operation is performed at the start by setting the start method [Hd132] at 01.
- In the case of the start method [Hd132] being set at 00, the magnetic poles are positioned to the output phases at the start. As a large offset between the magnetic poles and the output phases may fail the starting, use the DC braking force at start function to synchronize the magnetic-pole positions and the output phases before the starting.

■ Parameters common to this mode and the synchronous start mode.

Name	Code	Data range (unit)	Description
Control mode selection, 1st-motor	[AA121]	12	To use IVMS-start type sensorless vector control (SM/PMM).
Speed response, 1st-motor	[HA115]	0 to 1000(%)	To adjust the responsiveness of the control. A larger value enhances the responsiveness.
Minimum frequency adjustment for Sync.M, 1st-motor	[Hd130]	0 to 50(%)	At the frequency of [Hd130] × base frequency [Hd104], synchronous start control or IVMS start control is switched to sensorless control. By this setting, there is no effect on the frequency command like the [Hb103] Minimum frequency for IM.
No-Load current for Sync.M, 1st-motor	[Hd131]	0 to 100(%)	Set the ratio of the no-load current to the rated current during the sensorless vector control.
Starting method for Sync.M, 1st-motor	[Hd132]	00	Initial motor position estimation (IMPE) is disabled.
		01	Initial motor position estimation (IMPE) is enabled.
IMPE 0V wait number for Sync.M, 1st-motor	[Hd133]	0 to 255	This is a stand-by adjustment value to stabilize the reference value for the IMPE detection.
IMPE detect wait number for Sync.M, 1st-motor	[Hd134]	0 to 255	This is an adjustment value to stabilize the current rise of the IMPE operation.
IMPE detect number for Sync.M, 1st-motor	[Hd135]	0 to 255	This is a detection-operation adjustment value of the IMPE operation.
IMPE voltage gain for Sync.M, 1st-motor	[Hd136]	0 to 200(%)	This is a output-voltage adjustment gain of the IMPE operation.
IMPE Mg-pole position offset, 1st-motor	[Hd137]	0 to 359(°)	To perform corrections in a case where the IMPE operation has a certain error.
DC braking selection, 1st-motor	[AF101]	01	Internal DC braking: enabled
DC braking force at start, 1st-motor	[AF108]	0 to 100(%)	To adjust the DC braking force. Setting of 100% will provide maximum braking force.
DC braking active time at start, 1st-motor	[AF109]	0.0 to 60.0(s)	Enabled during the internal DC braking. When the operation command is turned ON, DC braking is started.
Overcurrent detection level, 1st-motor	[bb160]	Inverter ND rated current × (0.2 to 2.2)	To Set the level at which the over current is detected.

- Set-up procedures of IVMS start mode.



1

Set the protection for the PM motor.

- Setting the Overcurrent detection level [bb160]
- Setting the Electronic thermal level setting [bc110]



2

Set the PM motor's Plate Data.

- Setting the Sync. Motor capacity [Hd102]
- Setting the Sync. Motor number of poles [Hd103]
- Setting the Sync. Motor Base frequency [Hd104]
- Setting the Sync. Motor Maximum frequency [Hd105]
- Setting the Sync. Motor rated voltage [Hd106]
- Setting the Sync. Motor rated current [Hd108]



3

Set the PM motor constants.

- Setting the Sync. Motor constant R [Hd110].
- Setting the Sync. Motor constant Ld [Hd112].
- Setting the Sync. Motor constant Lq [Hd114].
- Setting the Sync. Motor constant Ke [Hd116].
- Setting the Sync. Motor constant J [Hd118].



4

Perform the IVMS auto-tuning.

- Set the control mode [AA121] at 12 (SM-IVMS).
- Set the auto-tuning selection [HA-01] at 03 (IVMS).
- Input the starting command for the auto-tuning (RUN command).
- The inverter will automatically be in running.
- Tuning is finished.



Next page.



- The over-current detection level should be set appropriately by taking into account the maximum current (demagnetization level) of the PM motor to be used. Set the over-current detection level so that the SM (PMM)'s maximum current (demagnetization level) is not below 150% of the over-current detection level.
- See also "**12.7.1 Electronic Thermal Settings of Motor**" and set it appropriately
- See also "**12.3.1 Parameter Settings of Motor Rating Data**" and set them appropriately.
- See also "**12.3.2 Motor Constant Settings**" and set them appropriately.
- For the procedures from the auto-tuning start to the auto-tuning finish, check "**12.3.3 Auto-Tuning of Motor**" and follow the procedures.
- In IVMS auto-tuning, the motor shaft is rotated little by little for tuning. Therefore, if the motor shaft is locked, or if the load is heavy, even a normal finish of the auto-tuning may result in an adjustment failure. Perform the IVMS auto-tuning with nothing attached to the motor shaft.
- When an over current occurs during the automatic operation of the IVMS auto-tuning, check the following items.
 - (1) Motor lock caused by braking and/or foreign matters.
 - (2) Setting the Overcurrent detection level [bb160]. Check these items, and when there is no problem, perform the IVMS auto-tuning by incrementing the SM(PMM)-IVMS minimum pulse width adjustment [Hd-50] by 10 each time.
- It may take approximately 5 minute to perform the IVMS auto-tuning.

5 Run test running.

- Set the Main speed reference setting or monitor [FA-01] at a value that is smaller than the Minimum frequency adjustment for Sync.M [Hd130], and check that stable drive can be provided for the forward revolutions, the backward revolutions, the acceleration, and the deceleration.
- Then, Set the [FA-01] at a value that is larger than the [Hd130], and check that stable drive can be provided for the forward revolutions, the backward revolutions, the acceleration, and the deceleration.



- When the adjustment has been performed repeatedly but no trial operation can be performed, it may be due to the unavailability of IVMS start mode for use. Use the synchronous starting mode, or please contact our sales office.

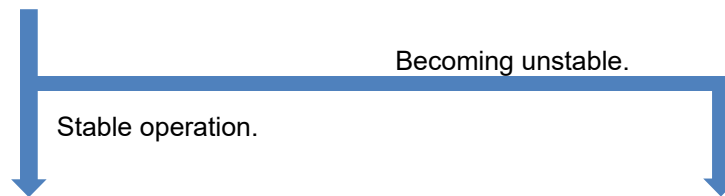

- Finish the test running. **Proceed to "6 Perform real operation."**

6 Perform real operation.

- Combine the target motor with a load device that you want to drive actually and then start the operation, and then check whether the motor can provide a stable drive. And the drive performance may be improved by parameters adjustment. For more details, see the following.
- For the adjustment of the high-speed (lowest frequency (switch) or higher), see also the descriptions of the synchronous starting mode.

- Change the following parameter settings re-perform **"4 Perform IVMS auto-tuning"**.

- (1) Open-phase voltage detection gain [Hd-43]:
Adjust by Incrementing the value from 00 to 03 by one each time.
- (2) SM(PMM)-IVMS minimum pulse width adjustment [Hd-50]:
Adjust by incrementing the value by 10 each time.



- During the real operation, do not change the following parameters set in **4 "Perform the IVMS auto-tuning"** and **"5 Run test running"**. Such changes may cause the driving instability.
- Open-phase voltage detection gain [Hd-43]
- SM(PMM)-IVMS minimum pulse width adjustment [Hd-50]

■ Not successful.

Phenomenon▶	Estimated cause(s)▶	Exemplar measures to be taken
Overcurrent occurs at the start.	<ul style="list-style-type: none"> • Insufficient starting torque. • Misalignment of the output phases and the motor's magnetic-pole positions. 	<ul style="list-style-type: none"> • Enable the Open-phase switching threshold compensation [Hd-44]. • Adjust each of the speed control P gain [Hd-45] and the speed control I gain [Hd-46] by 10 each time. Some motor characteristics require an adjustment by raising and lowering the settings. • Adjust the wait time for open-phase switching [Hd-47] by incrementing it by 5 each time. Some motor characteristics require an adjustment by raising and lowering the settings.
At the start, the motor step-out and no acceleration.		
Step-out, hunting, and/or over current occur at low speeds (at the lowest frequency(switch) or even lower).	<ul style="list-style-type: none"> • Insufficient torque • Misalignment of the output phases and the motor's magnetic-pole positions. 	<ul style="list-style-type: none"> • Enable the Open-phase switching threshold compensation [Hd-44]. • Adjust each of the speed control P gain [Hd-45] and the speed control I gain [Hd-46] by 10 each time. Some motor characteristics require an adjustment by raising and lowering the settings. • Adjust the wait time for open-phase switching [Hd-47] by incrementing it by 5 each time. Some motor characteristics require an adjustment by raising and lowering the settings.
Step-out, hunting, and/or over current occur at low speeds (at the lowest frequency(switch) or even lower) and with a heavy load.		<ul style="list-style-type: none"> • Adjust by decrementing the IVMS threshold current limit [Hd-51] by 5 each time. Some motor characteristics may provide instability with excessively small settings. • Adjust by decrementing the IVMS threshold gain [Hd-52] by 5 each time. Some motor characteristics require an adjustment by raising and lowering the settings.
The drive becomes unstable at low speeds (at the lowest frequency(switch) or even lower).	<ul style="list-style-type: none"> • Misalignment of the output phases and the motor's magnetic-pole positions. 	<ul style="list-style-type: none"> • Adjust by decrementing the Filter gain of IVMS current detection [Hd-42] by 5 each time. Some motor characteristics require an adjustment by raising and lowering the settings. • Adjust the SM(PMM)-IVMS wait time for open-phase switching [Hd-47] by incrementing it by 5 each time. Some motor characteristics require an adjustment by raising and lowering the settings.



- When the above-described procedures fail to allow successful adjustment, special adjustment may be necessary. Please contact our sales office.

12.9.17 Use Encoder

Q

- To set up the encoder when the revolution-speed feedback of a motor is used.

A

- In SJ-P1, the control with encoder and the absolute position control can be performed by inputting the feedback from the motor into the controller circuit terminal of the main body or into the feedback option P1-FB.
- When [CA-90] ≠ 00, Input terminals [A] and [B] of the main body are switched to dedicated terminals for pulse train input.
It is also required to set the input terminal functions 103 [PLA] and 104 [PLB] to the parameters [CA-10] and [CA-11] respectively.



- To perform the pulse train position control, terminals [SAP], [SBP], [SAN], and [SBN] of the feedback option P1-FB are used.
- When the feedback option P1-FB was once set in a slot and was removed later, a trip occurs with a feedback option connection error [E112].

- For feedback option P1-FB, encoder disconnection error [E100] can be enabled or disabled by setting the switch on the option. For more details, see the User's Guide of P1-FB.
- When [CA-90] = 02, the controls with encoder and the absolute position control are possible with Input terminals [A] and [B].
- When [CA-90] ≠ 02, the controls with encoder and the absolute position control are possible with terminals [EAP], [EBP], [EAN], and [EBN] of the feedback option P1-FB.

■ Parameters.

Name	Code	Data range (unit)	Description
Encoder constant setting (Internal)	[CA-81]	32 to 65535(pls)	Setting the encoder constant
Encoder phase sequence selection (Internal)	[CA-82]	00	Phase-A is leading.
		01	Phase-B is leading.
Motor gear ratio numerator (Internal)	[CA-83]	1 to 10000	Setting the numerator of the gear ratio of a motor.
Motor gear ratio denominator (Internal)	[CA-84]	1 to 10000	Setting the denominator of the gear ratio of a motor.
Pulse train input, target function selection (Internal)	[CA-90]	00	Disable
		01	Frequency reference
		02	Speed feedback
		03	Pulse count
Pulse train input mode selection (Internal)	[CA-91]	00	MD0: 90 degrees shift pulse train
		01	MD1: Forward/Reverse pulse train and direction signal
		02	MD2: Forward pulse train and reverse pulse train
Encoder constant setting (option)	[ob-01]	32 to 65535(pls)	Setting the encoder constant
Encoder phase sequence selection (option)	[ob-02]	00	Phase-A is leading.
		01	Phase-B is leading.
Motor gear ratio numerator (option)	[ob-03]	1 to 10000	Setting the numerator of the gear ratio of a motor.
Motor gear ratio denominator (option)	[ob-04]	1 to 10000	Setting the denominator of the gear ratio of a motor.
Pulse train input, target function selection (option)	[ob-10]	00	Frequency reference
		01	Pulse train position reference
Pulse train input mode selection (option)	[ob-11]	00	MD0: 90 degrees shift pulse train
		01	MD1: Forward/Reverse pulse train and direction signal
		02	MD2: Forward pulse train and reverse pulse train

Encoder's setting table.

	Setting description	Terminals [A] and [B] of main body	terminals [EAP], [EBP], [EAN], and [EBN] of P1-FB.
(1)	Encoder constant set-up	[CA-81]	[ob-01]
(2)	Encoder phase-sequence selection	[CA-82]	[ob-02]
(3)	Encoder gear ratio's numerator	[CA-83]	[ob-03]
(4)	Encoder's gear ratio's denominator	[CA-84]	[ob-04]



- When [CA-82] or [ob-02] is 00 (A phase lead), it is normal if the A phase leads the B phase by 90-degrees during forward rotation.
- When [CA-82] or [ob-02] is 01 (B phase lead), it is normal if the B phase leads the A phase by 90-degrees during forward rotation.
- To check if the encoder input into the main body or into P1-FB is correct, set [AA121] = 00, meaning V/f control (00), and check the [dA-08] Detect speed monitor. The wiring is correct if the forward operation [FW] has a positive (+) value and if the reversal operation [RV] has a negative (-) value. If it is incorrect, either revising the wiring or switching the corresponding encoder phase sequence selection [CA-82] or [ob-02].



- Table (1)Encoder constant-setup sets up the actual number of pulses of the encoder based on the terminals to be used.
- Table (2) encoder phase sequence selection is set up in accordance with the encoder's phase sequence.
- When [CA-90] = 02, the main-body speed feedback is enabled. When [CA-90] ≠ 02, P1-FB speed feedback is enabled.

Adjustment in cases where a gear exists between the motor and the encoder.



- When the encoder and motor shaft are connected by a gear, conversion can be performed by setting the encoder gear ratio numerator and encoder gear ratio denominator as shown in correspondence tables (3) and (4).
- Set the values ((3)/(4)) so as to be within a range between (1/50) to (20).
- An exemplar case where a gear is attached there.

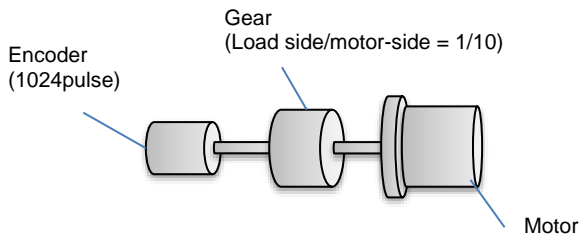

When the rotation ratio of the motor shaft reference is 1/10 for 1024 pulses in one rotation of the encoder,
 Table (1): Encoder constant set-up: 1024 pulses
 Table (3): Encoder's gear ratio's numerator: 1.
 Table (4): Encoder's gear ratio's denominator: 10
 Set up as above.

Encoder's speed detection.



- To acquire the frequency that was input through the encoder, the following settings are necessary.
 - Set-up of Tables (1), (3), and (4)
 - Set-up of the number of motor poles
 - * When the selected control mode [AA121] is the induction motor control ([AA121] = 00 to 10), setting of the IM motor pole number is set in the Async. Motor number of poles setting [Hb103].

■ Set-up of functions of the encoder feedback.



1 Check the encoder's set-up from the encoder's specifications.

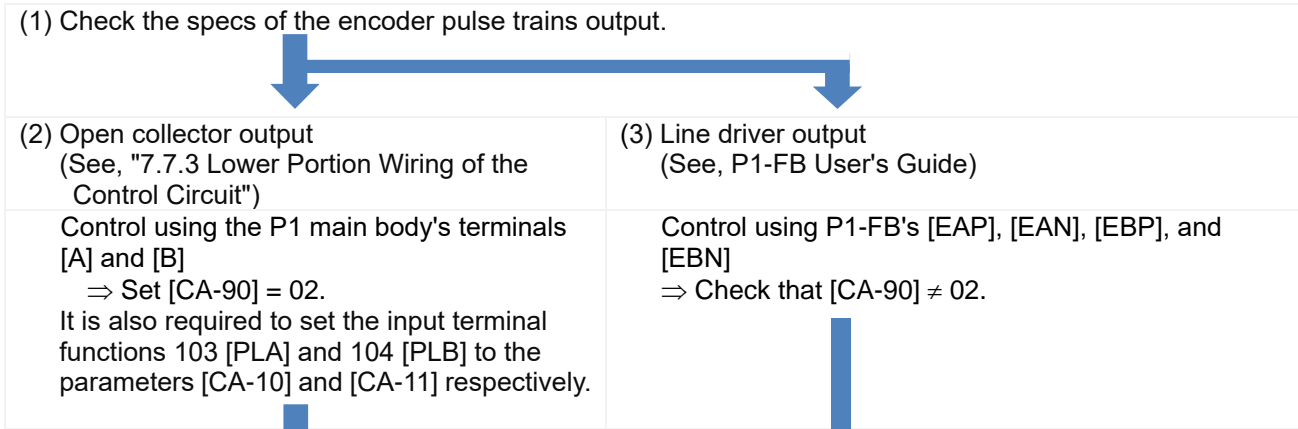

2 Set up the control mode.

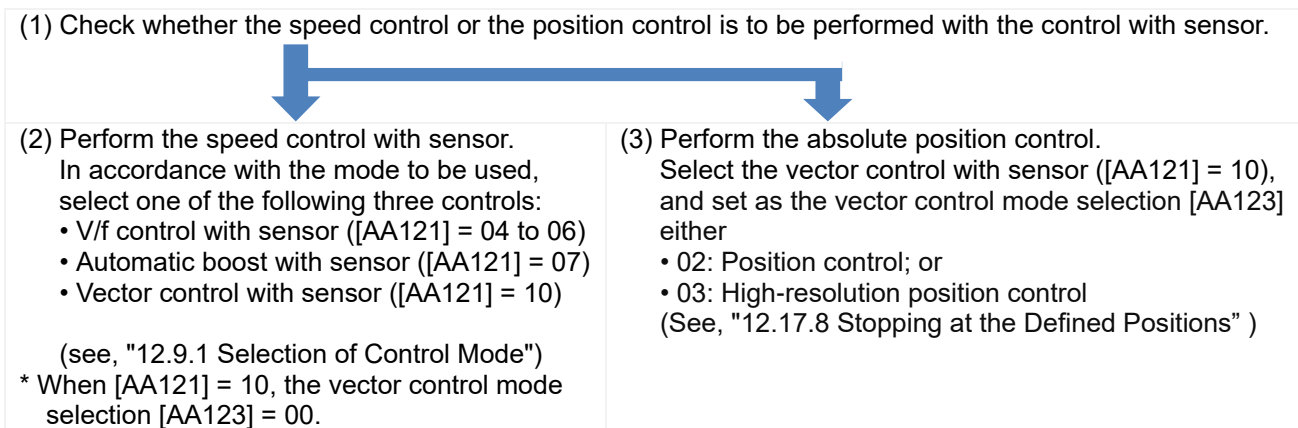

12.9.18 Check the Set-Up for the Pulse Train Input



- To check the related settings when either the encoder or the pulse generator is input.



- The following table shows the settings related to each control method and pulse train input.

Function used	Setting check	For pulse-train input
Speed control with sensor (V/f control)	Necessary settings; <ul style="list-style-type: none"> Control with sensor ([AA121] = 04 to 07) Selection of target for pulse train input detection. Related section; "12.9 Select the Appropriate Control Mode for the Motor and Load"	<ul style="list-style-type: none"> Input into P1 main body's terminals [A] and [B]. ([CA-90] = 02). Input into P1-FB's terminals [EAP], [EAN], [EBP], and [EBN]. ([CA-90] ≠ 02).
Vector control with sensor (Speed or Torque control)	Necessary settings; <ul style="list-style-type: none"> Vector control with sensor ([AA121] = 10 and [AA123] = 00). Selection of target for pulse train input detection. Related section; "12.9.15 Drive with Vector Control with Encoder" "12.11 Perform Torque Control Suitable for the Load "	
Absolute position control	Necessary settings; <ul style="list-style-type: none"> Vector control with sensor ([AA121] = 10 and [AA123] = 02, or [AA121] = 10 and [AA123] = 03). Selection of target for pulse train input detection. Related section; "12.9.15 Drive with Vector Control with Encoder" "12.17.9 Absolute Position Control Settings"	
Pulse train position control	Necessary settings; <ul style="list-style-type: none"> Vector control with sensor ([AA121] = 10 and [AA123] = 01). Pulse train input SA/SB ([ob-10] = 01) Related section; "12.17.7 Pulse Train Position Control Settings"	<ul style="list-style-type: none"> Input pulse train position command to P1-FB's terminals [SAP], [SAN], [SBP], and [SBN]. And Input position feedback from encoder to P1-FB's terminals [EAP], [EAN], [EBP], and [EBN]. (If necessary [EZP] and [EZN] too.) ([CA-90] ≠ 02).
Pulse train frequency reference (main body)	Necessary settings; <ul style="list-style-type: none"> Frequency reference ([AA101] = 12) Selection of target for pulse train input detection. Related section; "12.4.6 Making Command from Pulse Train Input"	<ul style="list-style-type: none"> Input into P1 main body's terminals [A] and [B]. ([CA-90] = 01).
Pulse train frequency reference (P1-FB)	Necessary settings; <ul style="list-style-type: none"> Frequency reference ([AA101] = 13). Pulse train input SA/SB ([ob-10] = 00). Related section; "12.4.6 Making Command from Pulse Train Input"	<ul style="list-style-type: none"> input into P1-FB's terminals [SAP], [SAN], [SBP], and [SBN]. ([CA-90] = 00).
Pulse count	Necessary settings; <ul style="list-style-type: none"> Selection of target for pulse train input detection. Related section; "12.4.6 Making Command from Pulse Train Input"	<ul style="list-style-type: none"> Input into P1 main body's terminals [A] and [B]. ([CA-90] = 03).

12.10 Perform Process Control Suitable for the System Using PID Control

12.10.1 Overview of the PID Functions

Q

- I want to perform process-control for flow rate, air flow, pressure and others.
- I want to switch PID control and normal control.
- I want to set soft-start for prevention of water hammer of the pump.
- I want to save energy by stopping the motor when the flow rate, air flow, pressure and others exceed a certain output.

A

- SJ-P1 is equipped with 4 independent PID functions, and each PID can be set independently.
- Four PID functions can be used for motor control by switching the [PIO1]/[PIO2] terminals.
- PID not used for motor control can be used for operation of exterior PID not related to inverter control freely.
- This helps to save space and cost because there is no need to install a separate PID controller.
- PID1 can be controlled based on 3 deviations.
- PID cascade control with the output of PID1 as the target value of PID2 is possible. More advanced PID control such as disturbance suppression is possible without adding an external PID unit.

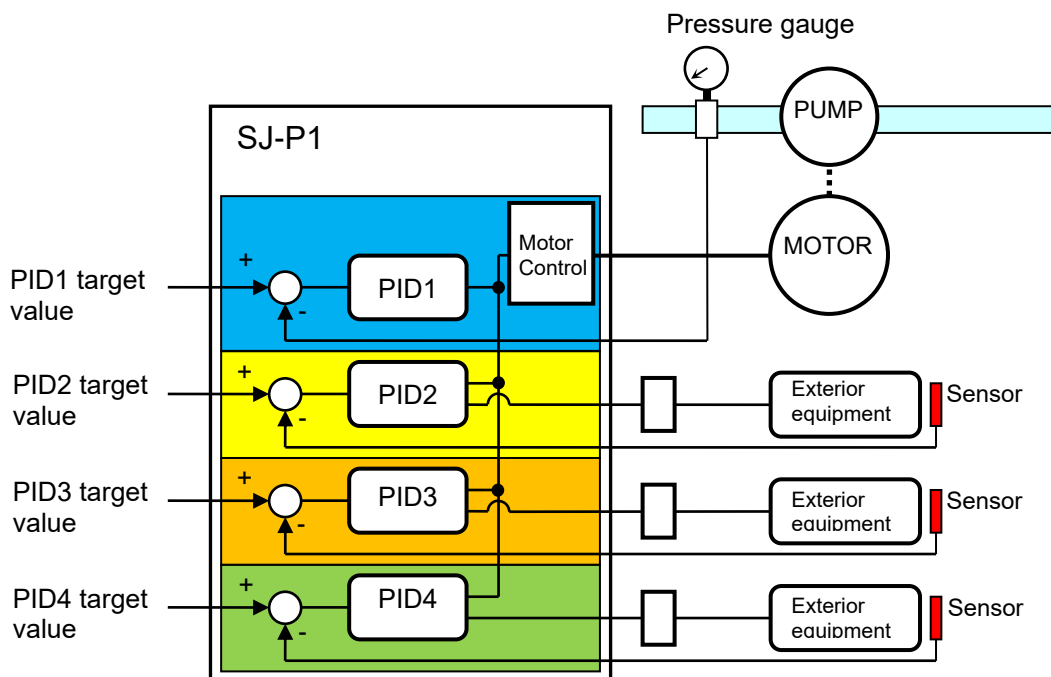

A

- To control the output frequency sent to the motor with the PID function, it is necessary to select PID1 to 4 and set the target value and feedback input for each.
- With the soft-start function of PID1, the output is increased by performing normal operation for a fixed time at the start-up, and then automatically shifts to PID control. See "12.10.3 PID Soft-Start Function".
- PID sleep function, which is more energy saving, can be set for when the flow rate or air volume is increased. See "12.10.4 PID Sleep and Wake Functions".
- During PID operation, the PID functions are disabled while the input terminals [PID]/[PID2]/[PID3]/[PID4] signal are turned ON, and normal frequency output is performed with the selected each target value setting as the frequency reference.
(In this case 100% set-point setting = maximum frequency setting.)
- Multi-stage target value setting is possible with PID1.
- Feedback control that stabilizes the disturbance and as well as feedforward control that stabilizes the disturbance is possible with PID1.

■ Basic composition of PID control.

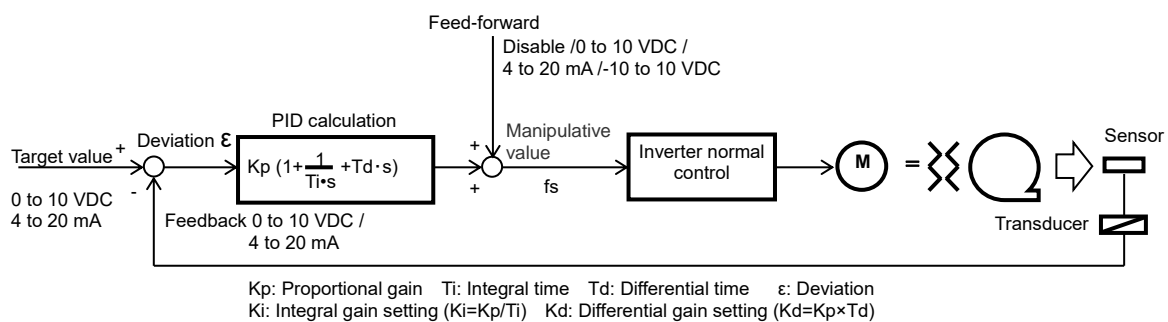

!

- In the case of controlling the motor by PID control, the Main speed input source selection [AA101] needs to be set to 15(PID calc.).
- The upper and lower limiter function operates for the frequency after the PID calculation output, not for the PID target value setting.

▼

e.g.) Follow the steps below to perform simple PID control by inputting a target value [Ai1] and a feedback (FB) value [Ai2] from where parameters are default.

- [1] Set [AH-01] to 01 (enable).
- [2] Set 15(PID calc.) to the Main speed input source selection [AA101].
- [3] Set 01 (Ai1) to the PID1 set-point 1 input source selection [AH-07].
- [4] Set 02 (Ai2) to the PID1 feedback 1 input source selection [AH-51].
- [5] Set the PID gain of PID1 to [AH-61] to [AH-63].
- [6] Input RUN command set to the RUN command input source selection [AA111] and start PID control.

■ PID operation.

- This section explains the individual controls using the case where the feedback (FB) value is constant and the PID target value is changed.

[1] P operation: P gain K_p

- This is an operation in which the PID manipulated variable is proportional to the deviation between the PID target value and the feedback (FB) value.
- PID manipulated variable can be adjusted by P gain.
- Deviation becomes (PID target value - FB value).

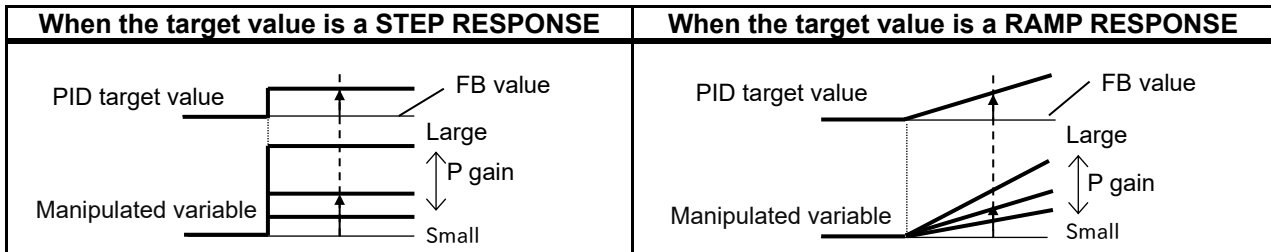

[2] I operation: I gain $K_i (=K_p/T_i)$

- PID manipulated variable is the time-integral value of the deviation between the PID target value and the feedback (FB) value.
- PID manipulated variable can be adjusted with I gain.
- Integral value can be cleared by the input function [PIDC].
- In P operation, When the deviation between PID target value and FB value becomes smaller, the manipulated variable also becomes smaller and it takes time to reach the target value, so I operation compensates for this.

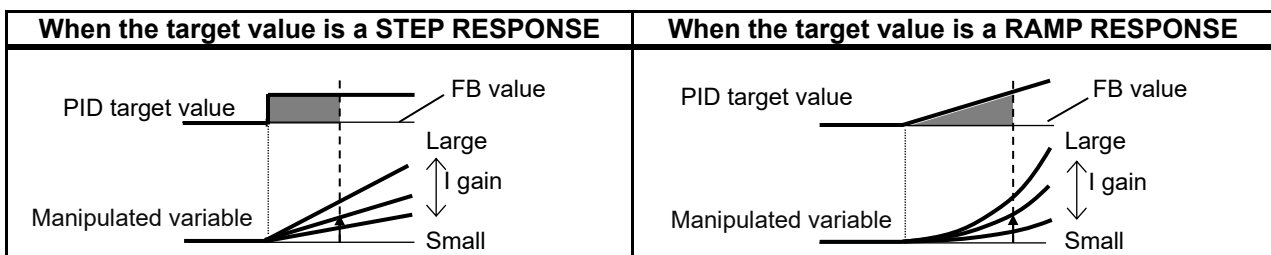

[3] D operation: D gain $K_d (=K_p \times T_d)$

- PID manipulated variable is the time-differentiated value of the deviation between the PID target value and the feedback (FB) value.
- PID manipulated variable can be adjusted by D gain.
- D operation has an effect to compensate the responsiveness of P operation and I operation.

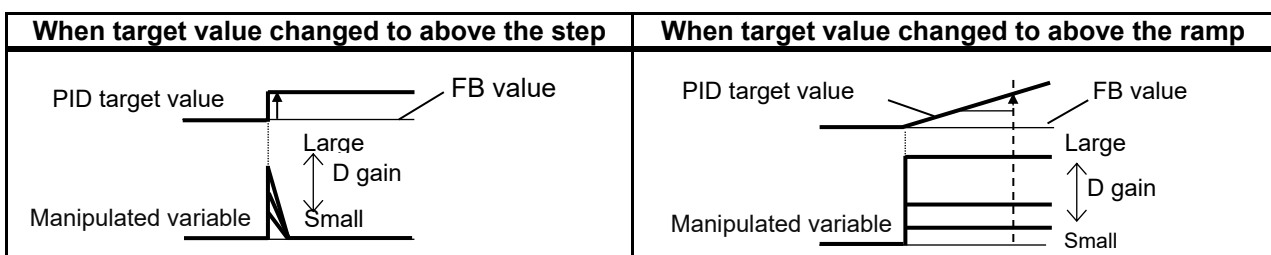

- PI operation is an operation with [1] and [2] combined.
- PD operation is an operation with [1] and [3] combined.
- PID operation is an operation with [1], [2] and [3] combined.

12.10.2 PID1 Functions Settings

A

- Three PID target values / PID feedback values can be input to PID1.
- Check the following block diagram.

- PID gain 1 and 2 can be switched by the input terminal function [PRO].
- PID1 output can be used as a target value of PID2.

■ Block diagram of PID1 control.

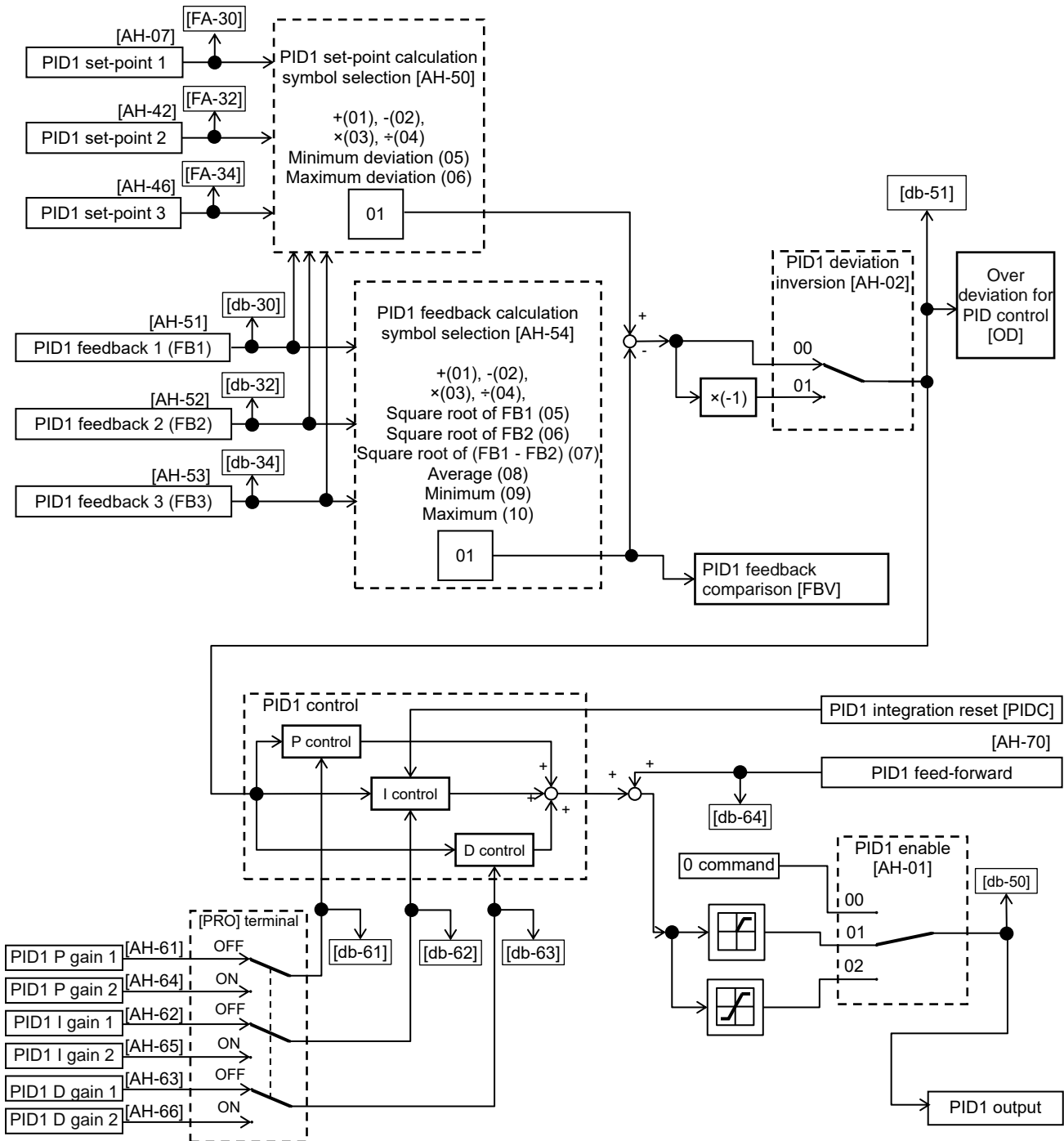

■ Parameters.

Name	Code	Data range (unit)	Description
PID1 enable	[AH-01]	00	Disable
		01	Enable (if command becomes negative, it does not output in a reverse direction)
		02	Enable (if command becomes negative, it outputs in a reverse direction)
PID1 deviation inversion	[AH-02]	00	Disable
		01	Enable (polarity inversion of deviation)
PID1 set-point 1 input source selection	[AH-07]	00 to 13	00(Not used)/ 01(Terminal[Ai1])/ 02(Terminal[Ai2])/ 03(Terminal[Ai3])/ 04(Terminal[Ai4])/ 05(Terminal[Ai5])/ 06(Terminal[Ai6])/ 07(Parameter setting)/ 08(RS485)/ 09(Option-1)/ 10(Option-2)/ 11(Option-3)/ 12(Pulse train input(internal))/ 13(Pulse train input(option))
PID1 set-point 1 setting	[AH-10]	-100.00 to 100.00(%) *1)	This is a set value when [AH-07] set to 07.
PID1 set-point 2 input source selection	[AH-42]	00 to 13	00(Not used)/ 01(Terminal[Ai1])/ 02(Terminal[Ai2])/ 03(Terminal[Ai3])/ 04(Terminal[Ai4])/ 05(Terminal[Ai5])/ 06(Terminal[Ai6])/ 07(Parameter setting)/ 08(RS485)/ 09(Option-1)/ 10(Option-2)/ 11(Option-3)/ 12(Pulse train input(internal))/ 13(Pulse train input(option))
PID1 set-point 2 setting	[AH-44]	-100.00 to 100.00(%) *1)	This is a set value when [AH-42] set to 07.
PID1 set-point 3 input source selection	[AH-46]	00 to 13	00(Not used)/ 01(Terminal[Ai1])/ 02(Terminal[Ai2])/ 03(Terminal[Ai3])/ 04(Terminal[Ai4])/ 05(Terminal[Ai5])/ 06(Terminal[Ai6])/ 07(Parameter setting)/ 08(RS485)/ 09(Option-1)/ 10(Option-2)/ 11(Option-3)/ 12(Pulse train input(internal))/ 13(Pulse train input(option))
PID1 set-point 3 setting	[AH-48]	-100.00 to 100.00(%) *1)	This is a set value when [AH-46] set to 07.
PID1 set-point calculation symbol selection	[AH-50]	01	(PID1 set-point 1) + (PID1 set-point 2)
		02	(PID1 set-point 1) - (PID1 set-point 2)
		03	(PID1 set-point 1) x (PID1 set-point 2)
		04	(PID1 set-point 1) / (PID1 set-point 2)
		05	Select the minimum deviation for inputs 1, 2, and 3.
		06	Select the maximum deviation for inputs 1, 2, and 3.

*1) Data range varies according to [AH-04],[AH-05],[AH-06] settings.

Name	Code	Data range (unit)	Description
PID1 feedback 1 input source selection	[AH-51]	00 to 13	00(Not used)/ 01(Terminal[Ai1])/ 02(Terminal[Ai2])/ 03(Terminal[Ai3])/ 04(Terminal[Ai4])/ 05(Terminal[Ai5])/ 06(Terminal[Ai6])/ 08(RS485)/ 09(Option-1)/ 10(Option-2)/ 11(Option-3)/ 12(Pulse train input(internal))/ 13(Pulse train input(option))
PID1 feedback 2 input source selection	[AH-52]	00 to 13	00(Not used)/ 01(Terminal[Ai1])/ 02(Terminal[Ai2])/ 03(Terminal[Ai3])/ 04(Terminal[Ai4])/ 05(Terminal[Ai5])/ 06(Terminal[Ai6])/ 08(RS485)/ 09(Option-1)/ 10(Option-2)/ 11(Option-3)/ 12(Pulse train input(internal))/ 13(Pulse train input(option))
PID1 feedback 3 input source selection	[AH-53]	00 to 13	00(Not used)/ 01(Terminal[Ai1])/ 02(Terminal[Ai2])/ 03(Terminal[Ai3])/ 04(Terminal[Ai4])/ 05(Terminal[Ai5])/ 06(Terminal[Ai6])/ 08(RS485)/ 09(Option-1)/ 10(Option-2)/ 11(Option-3)/ 12(Pulse train input(internal))/ 13(Pulse train input(option))
PID1 feedback calculation symbol selection	[AH-54]	01	(FB1)+(FB2)
		02	(FB1)-(FB2)
		03	(FB1)×(FB2)
		04	(FB1)÷(FB2)
		05	Square root of FB1
		06	Square root of FB2
		07	Square root of (FB1 - FB2)
		08	Average of FB1,FB2,FB3
		09	Minimum of FB1,FB2,FB3
		10	Maximum of FB1,FB2,FB3
PID1 gain change method selection	[AH-60]	00	Disable (gain 1 is used)
		01	Switch by [PRO] terminal
PID1 proportional gain 1	[AH-61]	0.0 to 100.0	Proportional gain
PID1 integral time constant 1	[AH-62]	0.0 to 3600.0(s)	Integral gain
PID1 derivative gain 1	[AH-63]	0.00 to 100.00(s)	Differential gain
PID1 proportional gain 2	[AH-64]	0.0 to 100.0	Proportional gain
PID1 integral time constant 2	[AH-65]	0.0 to 3600.0(s)	Integral gain
PID1 derivative gain 2	[AH-66]	0.00 to 100.00(s)	Differential gain
PID1 gain change time	[AH-67]	0 to 10000(ms)	Time for switch by [PRO] terminal operation
PID1 feed-forward input source selection	[AH-70]	00	Disable
		01	[Ai1] terminal input
		02	[Ai2] terminal input
		03	[Ai3] terminal input
		04	[Ai4] terminal input
		05	[Ai5] terminal input
		06	[Ai6] terminal input

■ Input terminal function.

Function name	Terminal symbol	Data	Description
Disable PID1	[PID]	041	Disables the PID1 function by turning ON the terminal function. When disabled, the set value of the selected PID set-point is used as the frequency reference.
PID1 integration reset	[PIDC]	042	Clears integral value of PID1 control.
Multi set-point selection 1	[SVC1]	051	Switches multiple target values.
Multi set-point selection 2	[SVC2]	052	
Multi set-point selection 3	[SVC3]	053	
Multi set-point selection 4	[SVC4]	054	
PID gain change	[PRO]	055	Switches PID gain 1 and 2 by input terminal.

■ Data monitor function.

Name	Code	Data range (unit)	Description
PID1 set-point 1 setting or monitor	[FA-30]	-100.00 to 100.00(%) *1)	Displays PID1 target value. This is changeable when [AH-07] = 07 or multi-stage target value 1 to 15 is enabled.
PID1 set-point 2 setting or monitor	[FA-32]	-100.00 to 100.00(%) *1)	Displays PID1 target value 2. Is changeable when [AH-42] = 07.
PID1 set-point 3 setting or monitor	[FA-34]	-100.00 to 100.00(%) *1)	Displays PID1 target value 3. Is changeable when [AH-46] = 07.
PID1 feedback value 1 monitor	[db-30]	-100.00 to 100.00(%) *1)	Displays PID1 feedback value 1.
PID1 feedback value 2 monitor	[db-32]	-100.00 to 100.00(%) *1)	Displays PID1 feedback value 2.
PID1 feedback value 3 monitor	[db-34]	-100.00 to 100.00(%) *1)	Displays PID1 feedback value 3.
PID1 target value monitor (after calculation)	[db-42]	-100.00 to 100.00(%) *1)	Displays target value after calculation by [AH-50].
PID1 feedback value monitor (after calculation)	[db-44]	-100.00 to 100.00(%) *1)	Displays feedback value after calculation by [AH-54].
PID1 output monitor	[db-50]	-100.00 to 100.00(%)	Displays PID1 output value.
PID1 deviation monitor	[db-51]	-200.00 to 200.00(%)	Displays PID1 deviation.
PID1 deviation 1 monitor	[db-52]	-200.00 to 200.00(%)	Monitors 3 deviations of PID1 when [AH-50] = 05 or 06.
PID1 deviation 2 monitor	[db-53]	-200.00 to 200.00(%)	
PID1 deviation 3 monitor	[db-54]	-200.00 to 200.00(%)	
Current PID P-Gain monitor	[db-61]	0.0 to 100.0	Displays current P gain.
Current PID I-Gain monitor	[db-62]	0.00 to 3600.00(s)	Displays current I gain.
Current PID D-Gain monitor	[db-63]	0.00 to 100.00(s)	Displays current D gain.
PID feedforward monitor	[db-64]	0.00 to 100.00(%)	Displays feed-forward command value.

*1) Data range varies according to [AH-04],[AH-05],[AH-06] settings.

■ PID1 set-point value selection.

- To set only one input Set-Point target value, set "00(Not used)" to [AH-42] and [AH-46] to disable the input source selection 2/3, and set "01(Addition)" to the [AH-50].

- Calculation result of operator [AH-50] will be restricted in a range of -100.00 to 100.00 (%).
- When 01 to 04 is selected in operator [AH-50], calculation is targeted to target value 1 and target value 2.



■ When [AH-50] is set to 01 to 04.

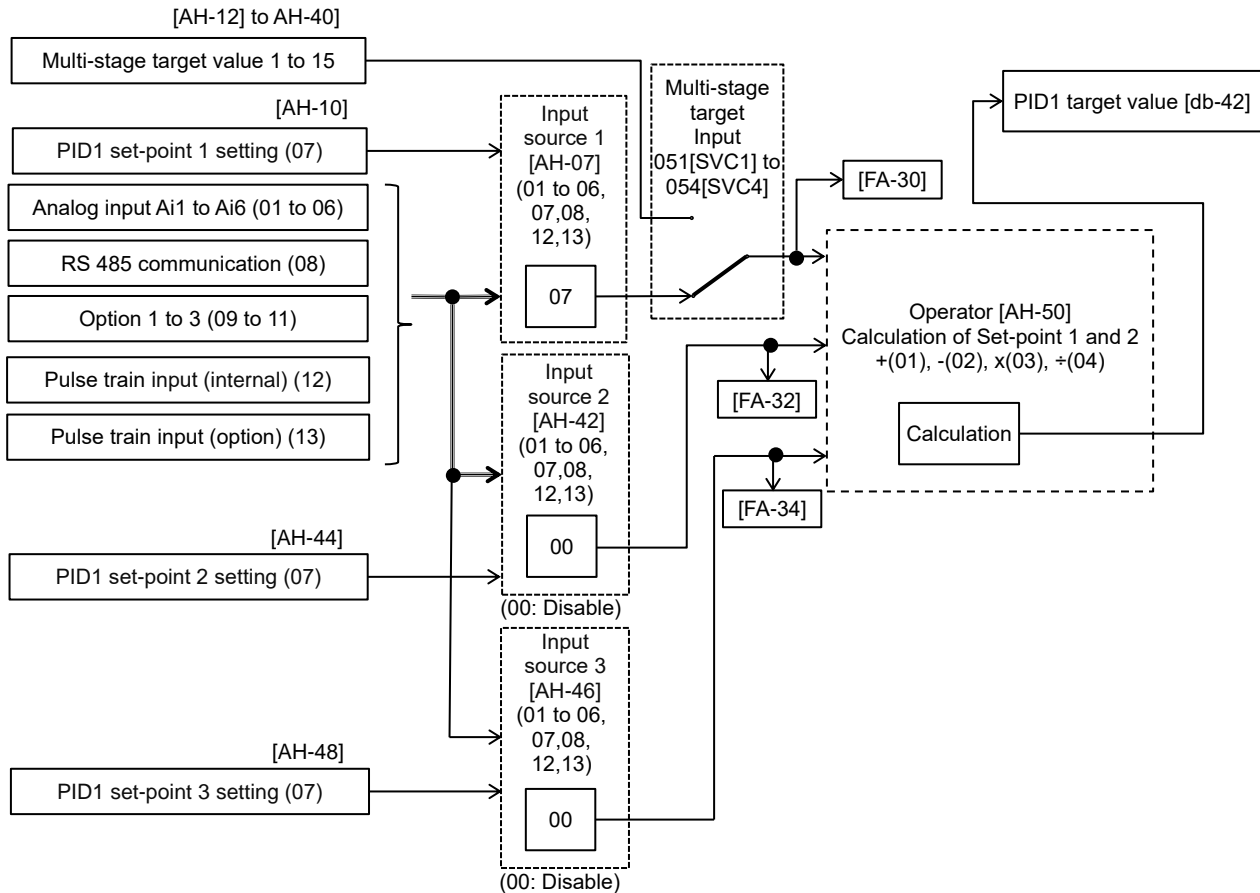

■ When [AH-50] is set to 05 or 06.

- When 05 or 06 is selected in [AH-50], (PID1 set-point 1) - (Feedback value 1), (PID1 set-point 2) - (Feedback value 2), (PID1 set-point 3) - (Feedback value 3), these 3 deviations are compared and PID calculation is performed by using the deviation of minimum (05) or maximum (06).



- For set-point value / feedback that are not used, select "00(Not used)" in the input source selection parameters.
- When the [AH-50] is set to 05 or 06, the [AH-54] is disabled.

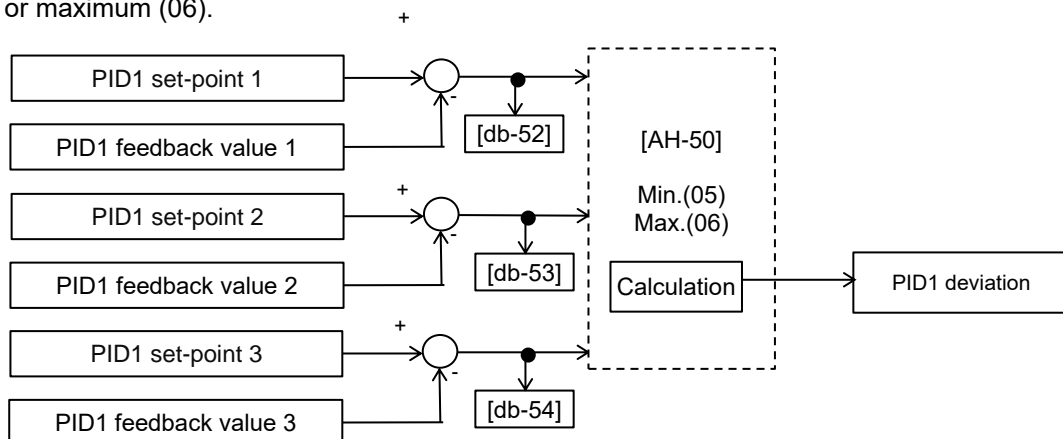

■ PID target value Multi set-point value switch function.

A

- PID1 Multi set-point value (0 to 15 speed) become selectable by assigning 051[SVC1] to 054[SVC4] to input terminals 1 to 9, A or B selection [CA-01] to [CA-11].

■ Operation table.

Multi set-point target	SVC4	SVC3	SVC2	SVC1	Parameter
Target value 0	OFF	OFF	OFF	OFF	[AH-10]*1)
Target value 1	OFF	OFF	OFF	ON	[AH-12]
Target value 2	OFF	OFF	ON	OFF	[AH-14]
Target value 3	OFF	OFF	ON	ON	[AH-16]
Target value 4	OFF	ON	OFF	OFF	[AH-18]
Target value 5	OFF	ON	OFF	ON	[AH-20]
Target value 6	OFF	ON	ON	OFF	[AH-22]
Target value 7	OFF	ON	ON	ON	[AH-24]
Target value 8	ON	OFF	OFF	OFF	[AH-26]
Target value 9	ON	OFF	OFF	ON	[AH-28]
Target value 10	ON	OFF	ON	OFF	[AH-30]
Target value 11	ON	OFF	ON	ON	[AH-32]
Target value 12	ON	ON	OFF	OFF	[AH-34]
Target value 13	ON	ON	OFF	ON	[AH-36]
Target value 14	ON	ON	ON	OFF	[AH-38]
Target value 15	ON	ON	ON	ON	[AH-40]

*1) When [AH-07] = 07. Follow the setting of [AH-07].



- Set the waiting time until the input terminals state is determined with the Multistage input determination time [CA-55] setting. It prevents the transition status of switching terminals from being selected.
- Data is finalized after the elapse of a set time for [CA-55] without input changes. Please be noted that setting a longer determination time makes the input response slow.

■ Operation graph.

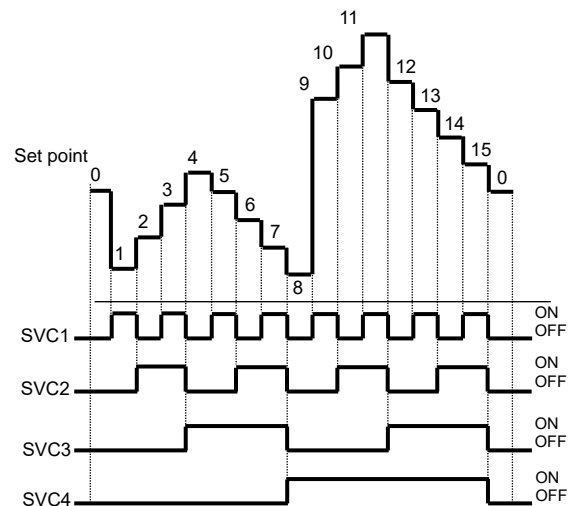

■ Input terminal function.

Function name	Terminal symbol	Data	Description
Multi set-point selection 1	[SVC1]	051	Switches multiple target values.
Multi set-point selection 2	[SVC2]	052	
Multi set-point selection 3	[SVC3]	053	
Multi set-point selection 4	[SVC4]	054	

■ PID1 target value selection.

Name	Code	Data range (unit)	Description
PID1 set-point 1 input source selection	[AH-07]	00 to 13	00(Not used)/ 01(Terminal[Ai1])/ 02(Terminal[Ai2])/ 03(Terminal[Ai3])/ 04(Terminal[Ai4])/ 05(Terminal[Ai5])/ 06(Terminal[Ai6])/ 07(Parameter setting)/ 08(RS485)/ 09(Option-1)/ 10(Option-2)/ 11(Option-3)/ 12(Pulse train input(internal))/ 13(Pulse train input(option))
PID1 set-point 1 setting	[AH-10]	-100.00 to 100.00[%] *1)	Is a parameter set value.
PID1 multistage set-point 1	[AH-12]		
PID1 multistage set-point 2	[AH-14]		
PID1 multistage set-point 3	[AH-16]		
PID1 multistage set-point 4	[AH-18]		
PID1 multistage set-point 5	[AH-20]		
PID1 multistage set-point 6	[AH-22]		
PID1 multistage set-point 7	[AH-24]		
PID1 multistage set-point 8	[AH-26]		
PID1 multistage set-point 9	[AH-28]		
PID1 multistage set-point 10	[AH-30]		
PID1 multistage set-point 11	[AH-32]		
PID1 multistage set-point 12	[AH-34]		
PID1 multistage set-point 13	[AH-36]		
PID1 multistage set-point 14	[AH-38]		
PID1 multistage set-point 15	[AH-40]		
PID1 set-point 2 input source selection	[AH-42]	00 to 13	00(Not used)/ 01(Terminal[Ai1])/ 02(Terminal[Ai2])/ 03(Terminal[Ai3])/ 04(Terminal[Ai4])/ 05(Terminal[Ai5])/ 06(Terminal[Ai6])/ 07(Parameter setting)/ 08(RS485)/ 09(Option-1)/ 10(Option-2)/ 11(Option-3)/ 12(Pulse train input(internal))/ 13(Pulse train input(option))
PID1 set-point 2 setting	[AH-44]	-100.00 to 100.00[%] *1)	This is a set value when [AF-42] set to 07.
PID1 set-point 3 input source selection	[AH-46]	00 to 13	00(Not used)/ 01(Terminal[Ai1])/ 02(Terminal[Ai2])/ 03(Terminal[Ai3])/ 04(Terminal[Ai4])/ 05(Terminal[Ai5])/ 06(Terminal[Ai6])/ 07(Parameter setting)/ 08(RS485)/ 09(Option-1)/ 10(Option-2)/ 11(Option-3)/ 12(Pulse train input(internal))/ 13(Pulse train input(option))
PID1 set-point 3 setting	[AH-48]	-100.00 to 100.00[%] *1)	This is a set value when [AF-46] set to 07.
PID1 set-point calculation symbol selection	[AH-50]	01	(PID1 set-point 1) + (PID1 set-point 2)
		02	(PID1 set-point 1) - (PID1 set-point 2)
		03	(PID1 set-point 1) x (PID1 set-point 2)
		04	(PID1 set-point 1) / (PID1 set-point 2)
		05	Select the minimum deviation for inputs 1, 2, and 3.
		06	Select the maximum deviation for inputs 1, 2, and 3.

*1) Data range varies according to [AH-04],[AH-05],[AH-06] settings.

■ PID1 feedback value selection.



- To set only one input feedback value, set “00(Not used)” to [AH-52] and [AH-53] to disable the input source selection 2/3, and set “01(Addition)” to the [AH-54].

- Calculation result of operator [AH-54] will be restricted in a range of -100.00 to 100.00 (%).

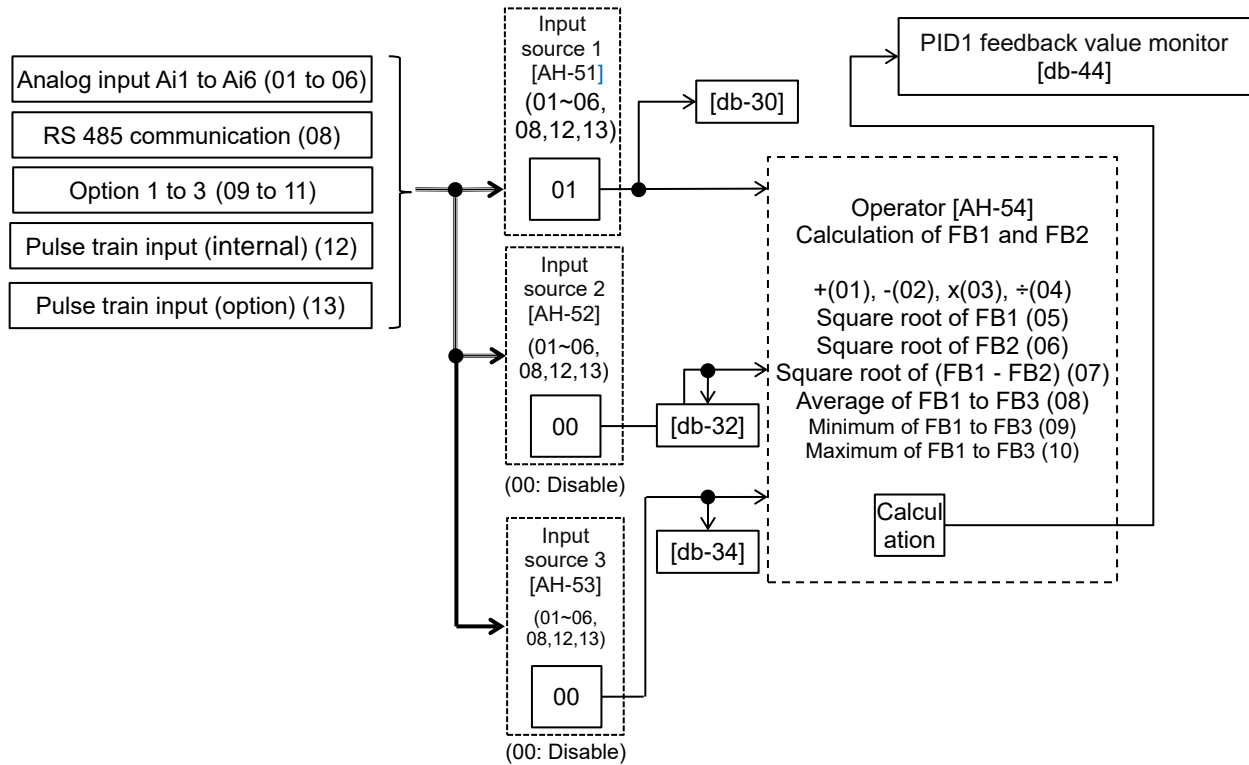

■ Behavior of operator [AH-54].



- When 01 to 07 is selected in operator [AH-54], calculation will be targeted to feedback value 1 and feedback value 2.
- When 08 to 10 is selected in operator [AH-54], calculation will be targeted to feedback value 1 to 3.



- Set 00(Not used) to the feedback input source selection parameters that is not used.
- Operator [AH-54] can use only when 01 to 04 is selected for the PID1 set-point calculation symbol selection [AH-50].

■ Invert the sign of PID1 deviation and output.

A

- The sign of the PID1 deviation output can be inverted.
- When the PID1 deviation inversion [AH-02] is 00, calculation will be performed by (PID set-point value - FB value). With 01, it will be the same operation as (FB value - PID set-point value).
- This is used when the polarity of the PID deviation does not match the inverter command due to the sensor characteristics, etc.

e.g.) Control the compressor for refrigerator.

When the temperature sensor specification is -20 to 100°C: 0 to 10 (V) and the target value is 0°C, and if the current temperature is 10°C, the speed will decrease in normal PID control as it is (FB value) > (PID target value).

- The inverter will raise the speed if [AH-02] = 01 is set.

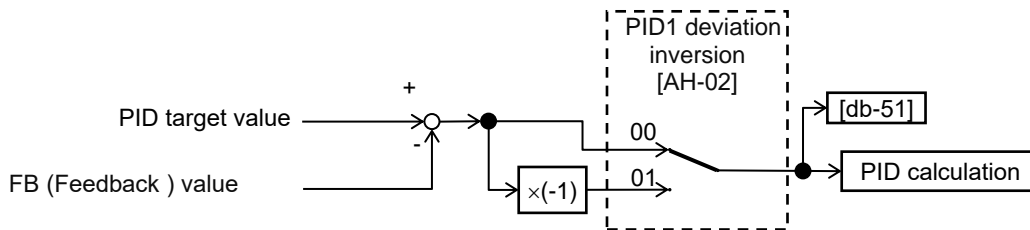

■ PID1 feed-forward value selection.

A

- For the feed forward control, by setting [AH-70] to a value other than 00, the function can be enabled and the input source can be selected.

!

- Note that this function is effective only for PID1.

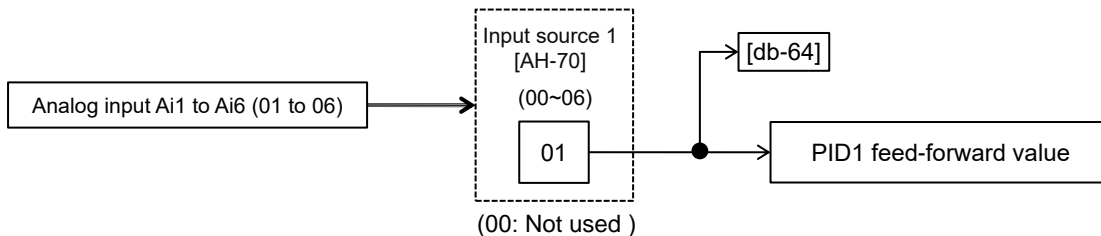

■ PID1 changeable range limitation.



- PID1 output limited range is changeable based on the PID1 target value.
- When [AH-71] is 0.00, the function is disabled.



- In the case of using this function, set the PID1 output range [AH-71]. It is limited within the range of PID target value \pm [AH-71] with the maximum frequency setting as 100%.

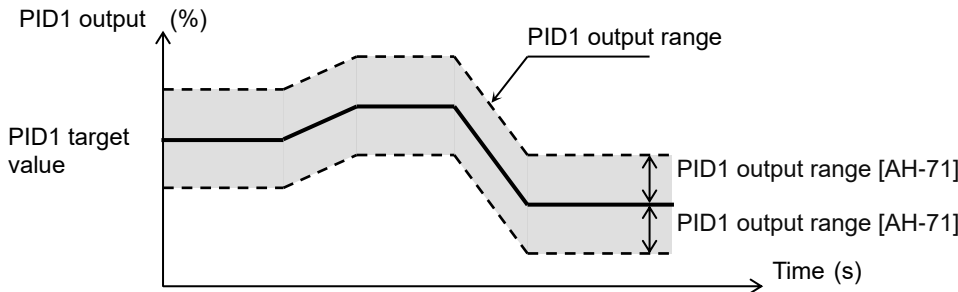

■ Parameter.

Name	Code	Data range (unit)	Description
PID1 output range	[AH-71]	0.00 to 100.00(%)	Changeable range based on the target value

■ PID1 reverse output.



- In normal PID control, when result of PID calculation is negative, the inverter does not output a negative output frequency and limits at 0 Hz. If select 02 (Enable with inverted output) for the PID1 enable [AH-01], output frequency can be output in a reverse direction, when result of PID calculation is negative.



- When [AH-01] is set to 02 (Enable with inverted output), the PID1 output range [AH-71] will be extended to the negative direction.

■ PID1 integral value reset function [PIDC].



- This is a function to clear the integral value of PID1 operation.
- In the case of turning ON the [PIDC] terminal, do so when PID1 is not in operation.



- Turning ON the [PIDC] terminal during PID1 operation clears the integral value added to the PID1 output command and changes the PID1 output command value abruptly, resulting in an overcurrent error or etc.

■ PID1 disable function [PID].



- Turning ON the [PID] terminal temporarily disables PID1 operation and performs output according to frequency reference.
- For the frequency reference, the value of the selected set-point input source selection is adopted. (When the set-point is 100%, frequency reference is maximum frequency setting.)

- Adjust PID1 control.
- When response is not stabilized in PID function operation, adjust according to the following procedure.



- If acceleration/deceleration time is set too long, following of output frequency will be delayed and control may not be successful. In this case, set the acceleration/deceleration time short.

Phenomenon ▶	Examples of measures
<ul style="list-style-type: none"> Output response is slow and feedback value does not change swiftly even if PID target value was changed. 	<ul style="list-style-type: none"> Increase PID1 proportional (P) gain 1 [AH-61].
<ul style="list-style-type: none"> Feedback value changes swiftly and is not stabilized. Overshooting or hunting occurs. 	<ul style="list-style-type: none"> Decrease PID1 proportional (P) gain 1 [AH-61].
<ul style="list-style-type: none"> Feedback value vibrates mildly. It takes time for operation to be stabilized. 	<ul style="list-style-type: none"> Increase PID1 integral (I) gain 1 [AH-62].
<ul style="list-style-type: none"> PID target value and feedback value do not match easily. 	<ul style="list-style-type: none"> Decrease PID1 integral (I) gain 1 [AH-62].
<ul style="list-style-type: none"> Response is slow even if proportional gain was increased. Small hunting occurs. 	<ul style="list-style-type: none"> Increase PID1 differential (D) gain 1 [AH-63].
<ul style="list-style-type: none"> Response due to disturbance is large and it takes time until stabilization. 	<ul style="list-style-type: none"> Decrease PID1 differential (D) gain 1 [AH-63].

- Control by switching PID1 gain.
- PID gain 1 and 2 can be switched by switching the input terminal function 055 [PRO].

- When using the [PRO] terminal, set the PID1 gain change method selection [AH-60] to 01.

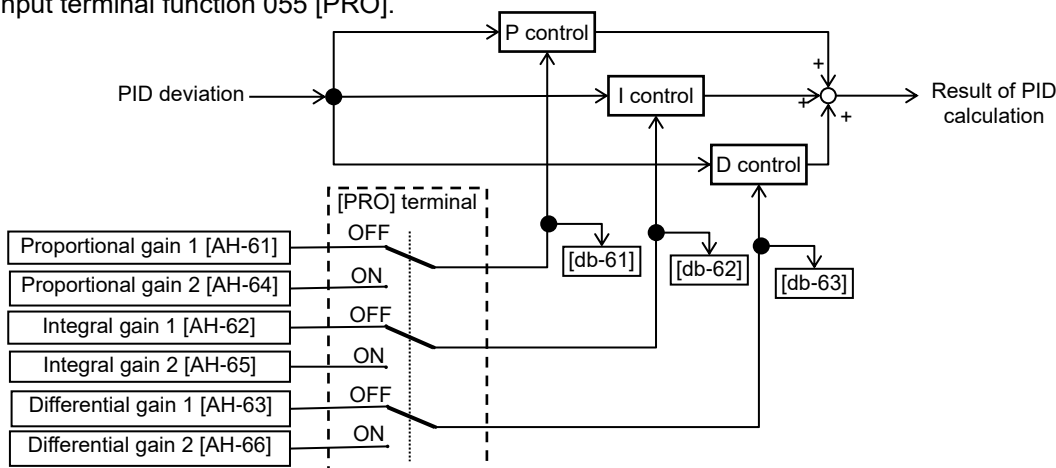

- The PID gain switches continuously at the PID1 gain change time [AH-67] as shown below.

- Each gain selected for PIDs can be checked by respective monitors [db-61] to [db-63].

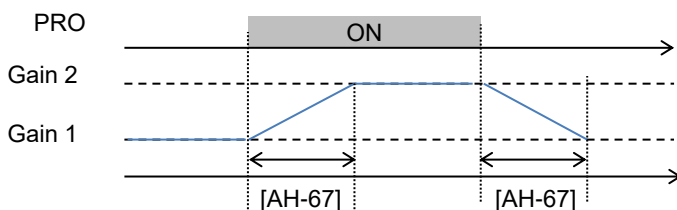

12.10.3 PID Soft-Start Function

■ PID soft-start function settings.

A

- In the case of using this function, enable PID1 control (set [AH-01] to 01 or 02) and set 01 to the PID soft-start function enable [AH-75].
- At the start of soft start, accelerate with the Acceleration time setting for PID soft start function [AH-80] until the Output Frequency reaches the PID soft start target level [AH-76].
- It will move to PID control automatically after the elapse of the time set in [AH-80].



- Note that this function is effective only for PID1.

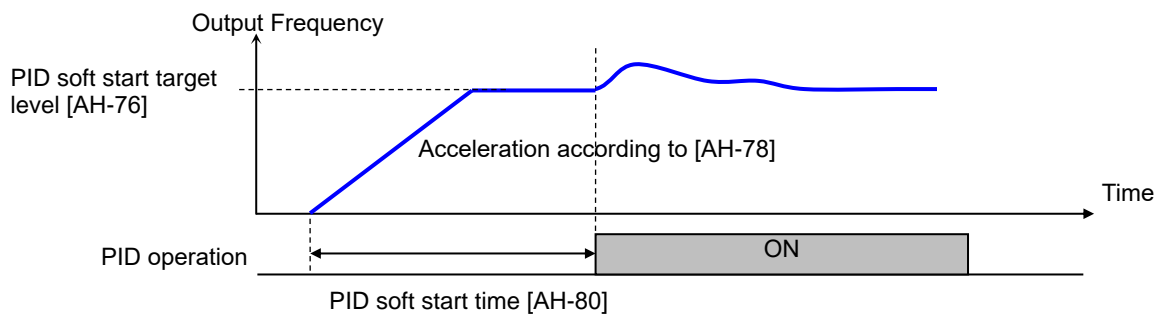

■ Parameter

Name	Code	Data range (unit)	Description
PID soft start function enable	[AH-75]	00	Disable
		01	Enable
PID soft start target level	[AH-76]	0.00 to 100.00(%)	It is a target value of the soft-start range with the maximum frequency as 100%.
Acceleration time setting for PID soft start function	[AH-78]	0.00 to 3600.00(s)	Sets acceleration time at the time of soft-start.
PID soft start time	[AH-80]	0.00 to 600.00(s) *1)	This is soft-start operation time.

* 1) The data range is 0.00 to 100.00 (s) for Ver2.01 or older.

■ PID start abnormal judgment.

A

- It is a function to detect breakage of pipes such as water leakage.
- As shown in the figure below, when the PID soft start time [AH-80] is elapsed after the start of the PID soft start operation, if the feedback value falls below the PID soft start error detection level [AH-82], it is judged as abnormal.
- When an abnormal is detected, abnormal operations vary depending on the setting of the PID soft start error detection enable [AH-81]:
 - when [AH-81] is 00, it is nothing occurred;
 - When [AH-81] is 01, the trip [E120] PID start error is occurred after the set time of [AH-80] is elapsed;
 - When [AH-81] is 02, the warning [SSE] terminal is turned ON after the set time of [AH-80] is elapsed. The [SSE] terminal stays ON while the inverter is in running;

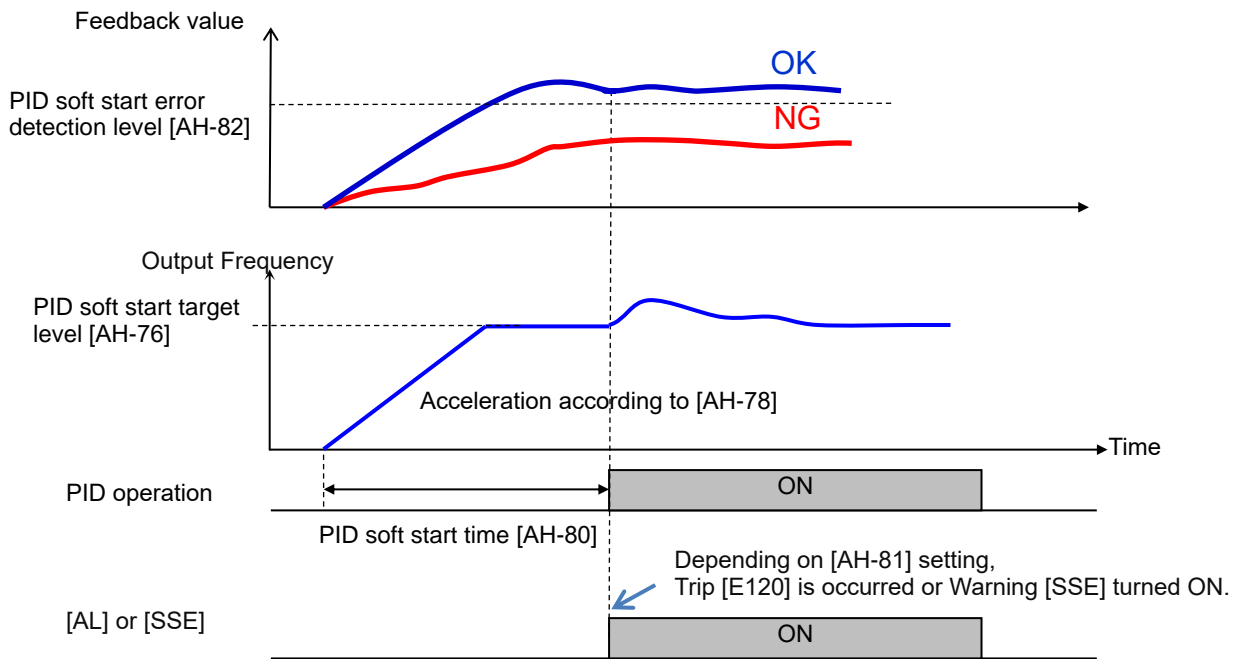

■ Parameter.

Name	Code	Data range (unit)	Description
PID soft start error detection enable	[AH-81]	00	Disable
		01	Enable: Error It will trip with [E120] PID start abnormality error when start abnormality is judged.
		02	Enable: Warning The [SSE] terminal will be turned ON when start abnormality is judged.
PID soft start error detection level	[AH-82]	0.00 to 100.00(%)	This is a level to judge start abnormality.

12.10.4 PID Sleep and Wake Functions

■ PID sleep and wake function settings.

A

- In the case of using this function, set 01 (output low) or 02 (SLEP terminal) to the PID sleep trigger selection [AH-85].
- The time and level for starting and canceling sleep operation can be changed according to the application.

- To cancel the PID sleep state, select 01 (Deviation), 02 (Low feedback) or 03 ([WAKE] terminal) with PID wake trigger selection [AH-93].
- When the PID sleep cancel by deviation, even if the sign of PID deviation is switched by setting [AH-02] to 01, the sleep is canceled only when the deviation expands in the direction in which the output decreases.

!

- Note that this function is effective only for PID1.

■ Parameter.

Name	Code	Data range (unit)	Description
PID sleep trigger selection	[AH-85]	00	Disable
		01	Starts sleep operation when output is low
		02	Starts operation at the rising edge of the [SLEP] terminal
PID sleep start level	[AH-86]	0.00 to 590.00(Hz)	This is a level of making a judgment of sleep operation for the output speed when [AH-85] = 01.
PID sleep active time	[AH-87]	0.00 to 100.00(s)	This is stand-by time before shifting to sleep operation.
Enable set-point boost before PID sleep	[AH-88]	00	Disable
		01	Boosts target value before sleep operation.
Set-point boost time before PID sleep	[AH-89]	0.00 to 100.00(s)	This is actuation time prior to PID sleep.
Set-point boost value before PID sleep	[AH-90]	0.00 to 100.00(%)	Sets a boost amount to be added to target value before sleep.
Minimum RUN time before PID sleep	[AH-91]	0.00 to 100.00(s)	Does not start sleep operation until [AH-91] has elapsed from start.
Minimum active time of PID sleep	[AH-92]	0.00 to 100.00(s)	Retains the sleep status until [AH-92] has elapsed, once the sleep operation started.
PID wake trigger selection	[AH-93]	01	Cancels the sleep operation when a deviation amount increases in a deceleration direction.
		02	Cancels the sleep operation when feedback value decreases.
		03	Cancels the sleep operation at the rising edge of the [WAKE] terminal
PID wake start level	[AH-94]	0.00 to 100.00(%)	Cancels the operation when feedback value goes below the set value when [AH-93] is 02.
PID wake start time	[AH-95]	0.00 to 100.00(s)	Is stand-by time for operation cancellation when [AH-93] is 02.
PID wake start deviation value	[AH-96]	0.00 to 100.00(%)	Cancels the operation when a deviation between target value and feedback value increases when [AH-93] is 01.

■ Input terminal function.

Function name	Terminal symbol	Data	Description
SLEEP condition activation	[SLEP]	058	Starts the sleep function with the terminal when [AH-85] = 02.
WAKE condition activation	[WAKE]	059	Cancels the sleep function with the terminal when [AH-93] = 03.

(Example 1)

- [AH-85] PID sleep trigger: 01 (output low)
- If the output frequency falls below the [AH-86] set value and continues for the [AH-87] set time, PID sleep operation starts.

- [AH-93] PID wake trigger: 01 (deviation)
- If the PID deviation exceeds the [AH-96] set value and continues for the [AH-95] set time, PID wake operation starts. Deviation operates with either figure (\pm).

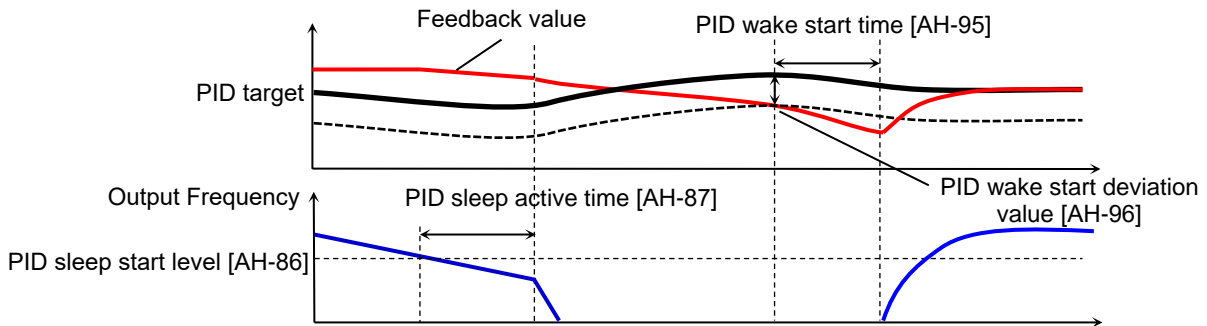

(Example 2)

- [AH-85] PID sleep trigger: 01 (output low)
- If the output frequency falls below the [AH-86] set value and continues for the [AH-87] set time, PID sleep operation starts.

- [AH-93] PID wake trigger: 02 (feedback low)
- If the feedback value falls below the [AH-94] set value and continues for the [AH-95] set time, PID wake operation starts.

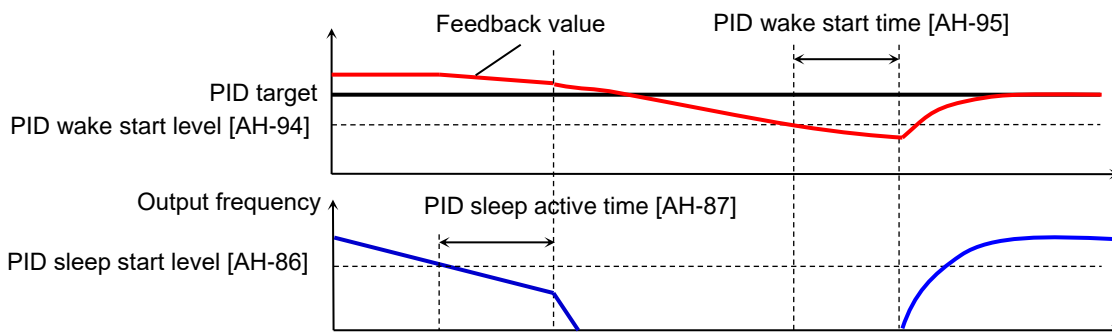

(Example 3)

- [AH-85] PID sleep trigger: 02 ([SLEP] terminal)
- Sleep operation starts after the elapse of [AH-87] from the ON edge of the [SLEP] terminal.

- [AH-93] PID wake trigger: 03 ([WAKE] terminal)
- Wake operation starts after the elapse of [AH-95] from the ON edge of the [WAKE] terminal.

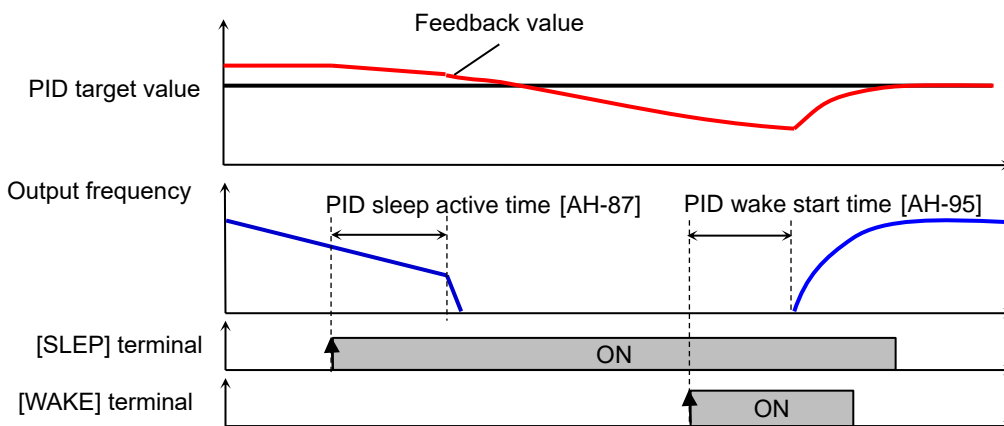

■ Boost function before PID sleep.

A

- Before starting PID sleep, increase the PID target value to temporarily increase the feedback value. This makes it possible to maintain the PID sleep state for a longer time.
- The figure below is an example when the [AH-85] PID sleep trigger set to 01(output low) and set the [AH-93] PID wake trigger to 02(feedback low).

- When [AH-88] is 01 (Enable), before the start of PID sleep, the Set-point boost value [AH-90] is added to the PID target value while the Set-point boost time [AH-89].

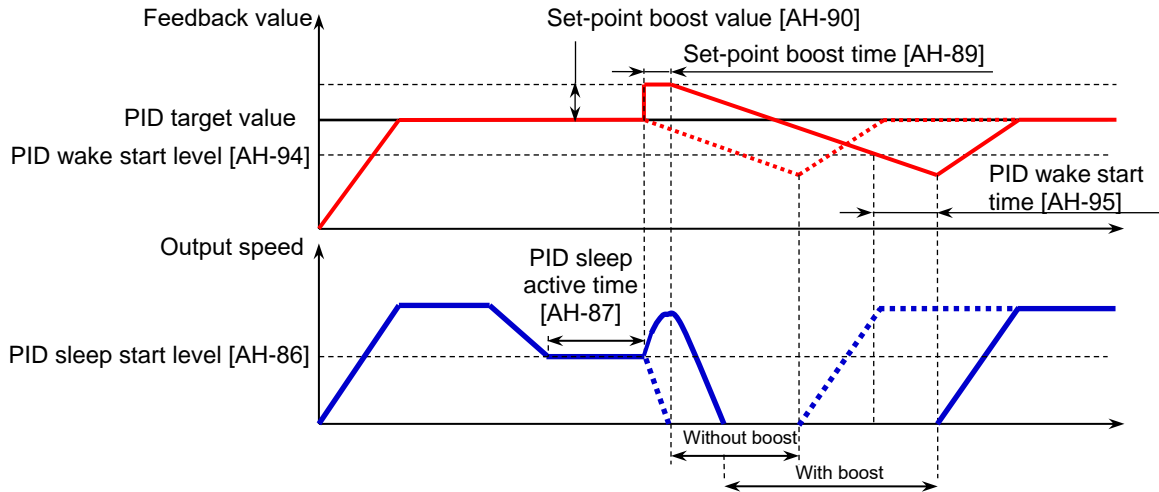

■ Sleep function disable time.

A

- The Minimum RUN time before PID sleep [AH-91] and The Minimum active time of PID sleep [AH-92] can be set.

- By setting these parameters, it is possible to prevent that frequently switches between the PID sleep state and the PID wake state during PID operation.

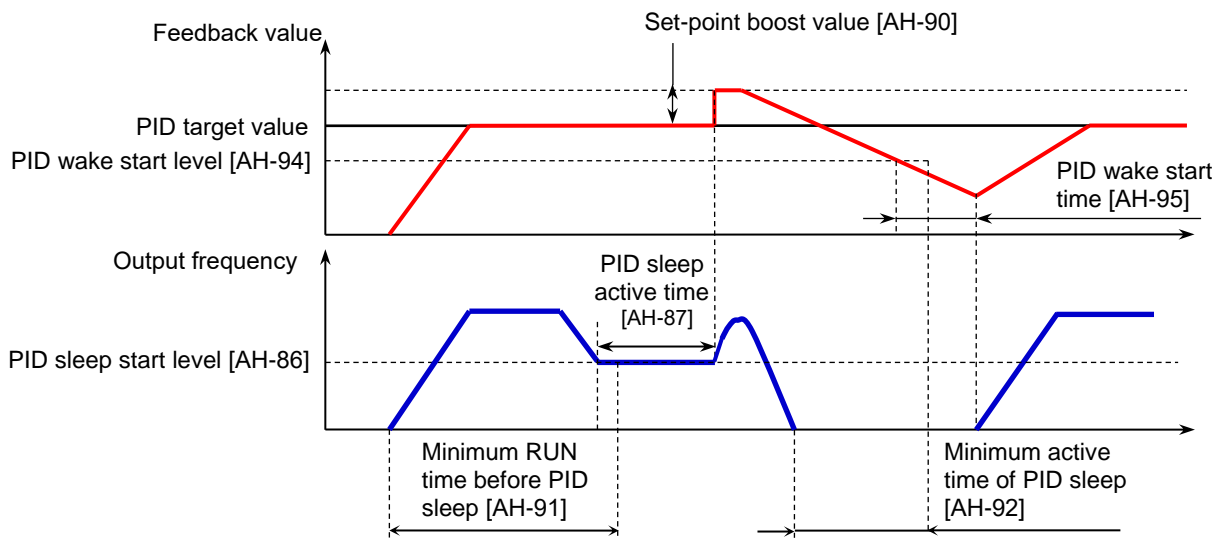

12.10.5 PID2/PID3/PID4 Functions Settings

■ PID2/PID3/PID4 control.

A

- PID1 to PID4 controls operate independently.
- By switching the operation of PID1 to PID4 with the input terminal, it can be applied to the switching of Batch control, etc.

- For PID2, the PID calculation output of PID1 can be selected as the target value. Therefore, advanced control with more higher response is possible with this cascade control.

■ Block diagram of PID2 control.

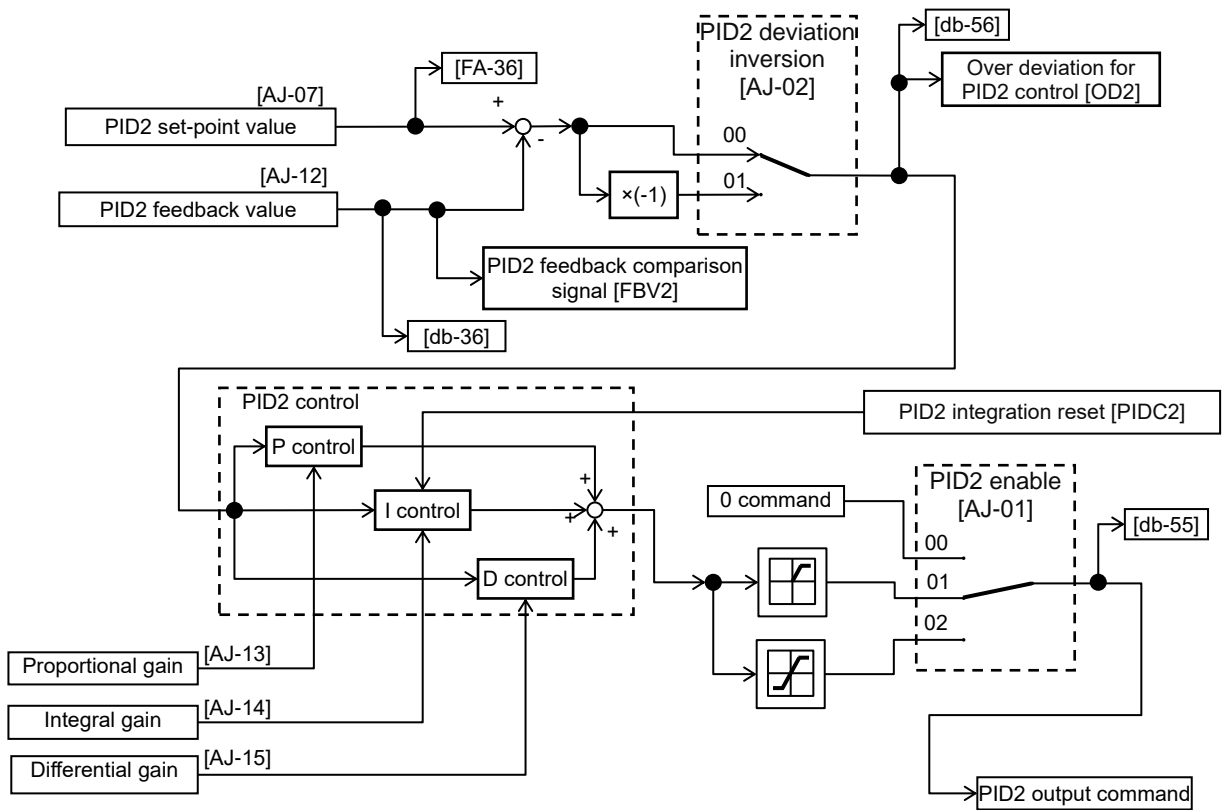

■ Block diagram of PID3 control.

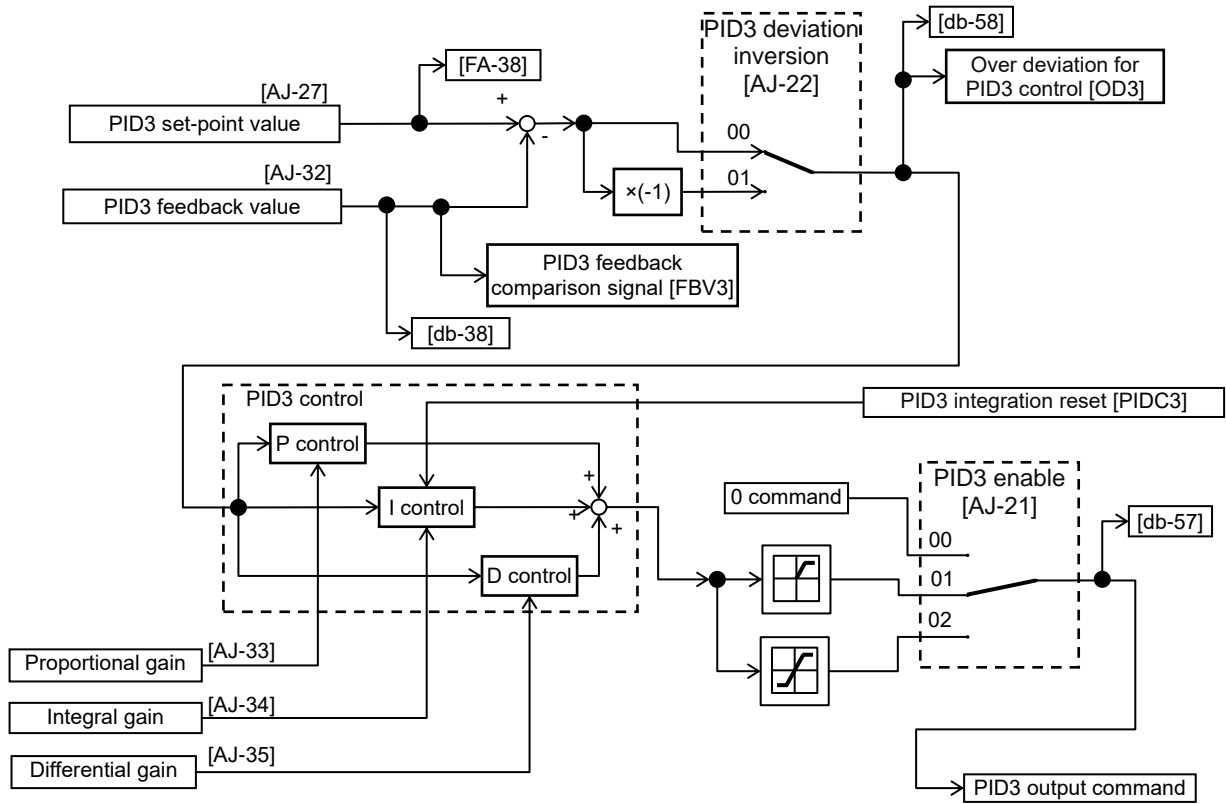

■ Block diagram of PID4 control.

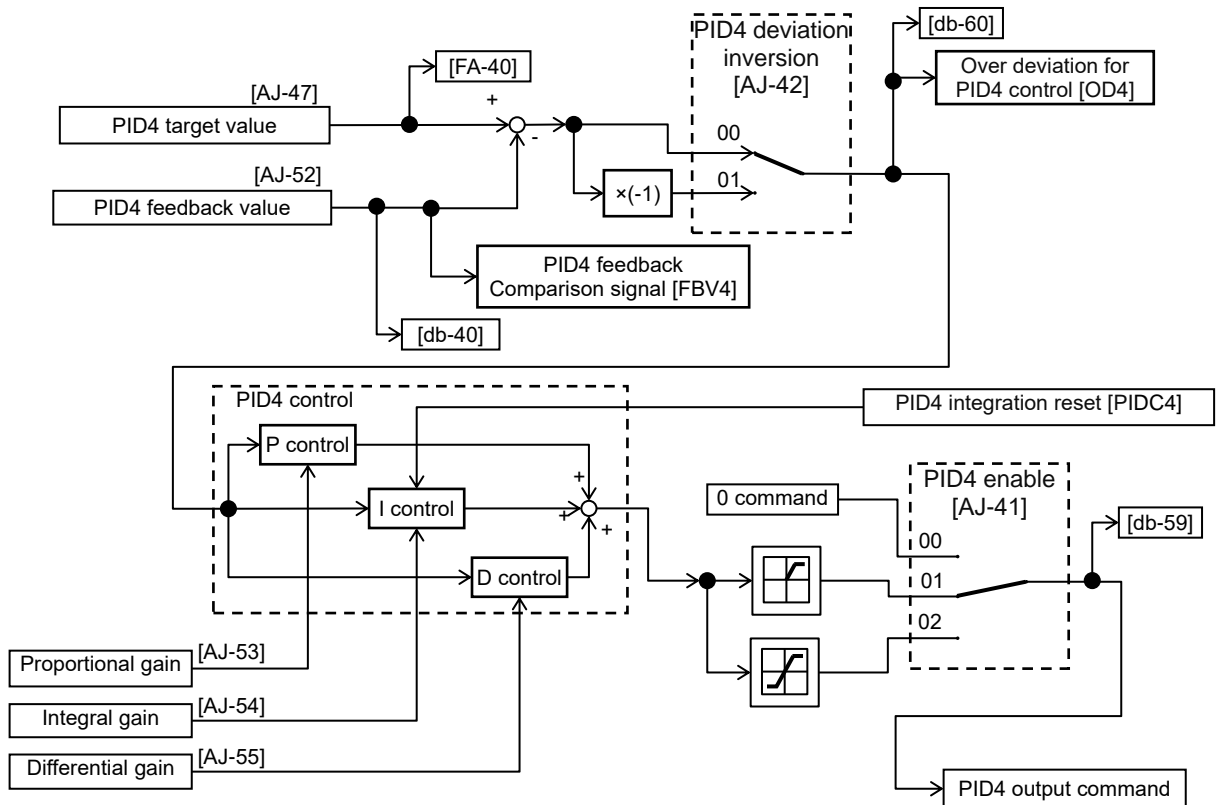

■ Switch PID1 to 4.

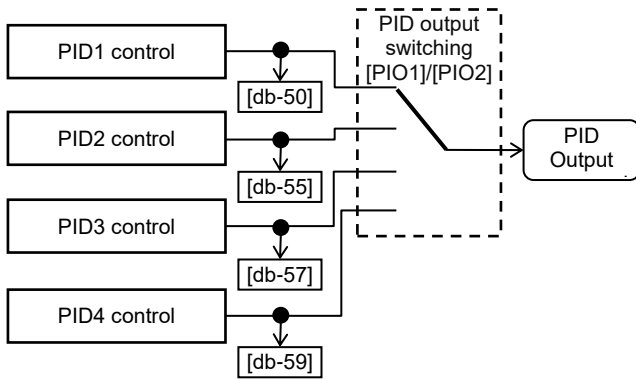

- Switching the input terminal function 056[PIO1]/057[PIO2] enables switching and controlling of PID1 to PID4.

Combination of PIO1/PIO2

	[PIO2]	[PIO1]
PID1 is enabled	OFF	OFF
PID2 is enabled	OFF	ON
PID3 is enabled	ON	OFF
PID4 is enabled	ON	ON

■ Connect PID1 and PID2.

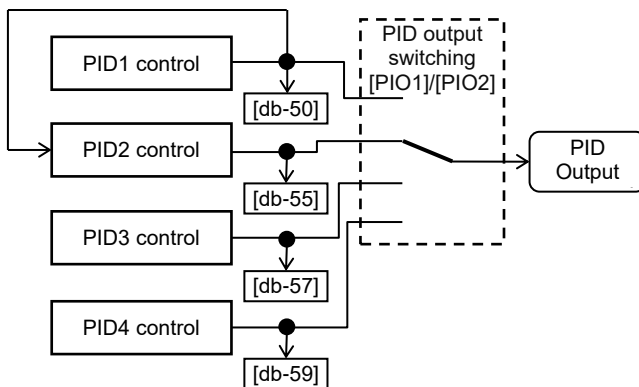

- Setting the target set point value of PID2 to output of PID1 ([AJ-07] = 15) can enable cascade control of PID1 and PID2. (PID3/PID4 cannot be selected.)
- Enable PID2 output command as follows.

Combination of PIO1/PIO2

	[PIO2]	[PIO1]
PID2 is enabled	OFF	ON

■ Parameters.

Name	Code	Data range (unit)	Description
PID2 enable	[AJ-01]	00	Disable
		01	Enable (if command becomes negative, it does not output in a reverse direction)
		02	Enable (if command becomes negative, it outputs in a reverse direction)
PID2 deviation inversion	[AJ-02]	00	Disable
		01	Enable (polarity inversion of deviation)
PID2 set-point input source selection	[AJ-07]	00 to 13,15	00(Not used)/ 01(Terminal[Ai1])/ 02(Terminal[Ai2])/ 03(Terminal[Ai3])/ 04(Terminal[Ai4])/ 05(Terminal[Ai5])/ 06(Terminal[Ai6])/ 07(Parameter setting)/ 08(RS485)/ 09(Option-1)/ 10(Option-2)/ 11(Option-3)/ 12(Pulse train input(internal))/ 13(Pulse train input(option))/ 15(PID1 output)
PID2 set-point setting	[AJ-10]	-100.00 to 100.00(%)*1)	This is a set value when [AJ-07] set to 07.
PID2 feedback input source selection	[AJ-12]	00 to 06, 08 to 13	00(Not used)/ 01(Terminal[Ai1])/ 02(Terminal[Ai2])/ 03(Terminal[Ai3])/ 04(Terminal[Ai4])/ 05(Terminal[Ai5])/ 06(Terminal[Ai6])/ 08(RS485)/ 09(Option-1)/ 10(Option-2)/ 11(Option-3)/ 12(Pulse train input(internal))/ 13(Pulse train input(option))
PID2 proportional gain	[AJ-13]	0.0 to 100.0	Proportional gain
PID2 integral time constant	[AJ-14]	0.0 to 3600.0(s)	Integral gain
PID2 derivative gain	[AJ-15]	0.00 to 100.00(s)	Differential gain
PID3 enable	[AJ-21]	00	Disable
		01	Enable (if command becomes negative, it does not output in a reverse direction)
		02	Enable (if command becomes negative, it outputs in a reverse direction)
PID3 deviation inversion	[AJ-22]	00	Disable
		01	Enable (polarity inversion of deviation)
PID3 set-point input source selection	[AJ-27]	00 to 13	00(Not used)/ 01(Terminal[Ai1])/ 02(Terminal[Ai2])/ 03(Terminal[Ai3])/ 04(Terminal[Ai4])/ 05(Terminal[Ai5])/ 06(Terminal[Ai6])/ 07(Parameter setting)/ 08(RS485)/ 09(Option-1)/ 10(Option-2)/ 11(Option-3)/ 12(Pulse train input(internal))/ 13(Pulse train input(option))
PID3 set-point setting	[AJ-30]	-100.00 to 100.00(%)*2)	This is a set value when [AJ-27] set to 07.
PID3 feedback input source selection	[AJ-32]	00 to 06, 08 to 13	00(Not used)/ 01(Terminal[Ai1])/ 02(Terminal[Ai2])/ 03(Terminal[Ai3])/ 04(Terminal[Ai4])/ 05(Terminal[Ai5])/ 06(Terminal[Ai6])/ 08(RS485)/ 09(Option-1)/ 10(Option-2)/ 11(Option-3)/ 12(Pulse train input(internal))/ 13(Pulse train input(option))
PID3 proportional gain	[AJ-33]	0.0 to 100.0	Proportional gain
PID3 integral time constant	[AJ-34]	0.0 to 3600.0(s)	Integral gain
PID3 derivative gain	[AJ-35]	0.00 to 100.00(s)	Differential gain

*1) Data range varies according to [AJ-04],[AJ-05],[AJ-06] settings.

*2) Data range varies according to [AJ-24],[AJ-25],[AJ-26] settings.

■ Parameters.

Name	Code	Data range (unit)	Description
PID4 enable	[AJ-41]	00	Disable
		01	Enable (if command becomes negative, it does not output in a reverse direction)
		02	Enable (if command becomes negative, it outputs in a reverse direction)
PID4 deviation inversion	[AJ-42]	00	Disable
		01	Enable (polarity inversion of deviation)
PID4 set-point input source selection	[AJ-47]	00 to 13	00(Not used)/ 01(Terminal[Ai1])/ 02(Terminal[Ai2])/ 03(Terminal[Ai3])/ 04(Terminal[Ai4])/ 05(Terminal[Ai5])/ 06(Terminal[Ai6])/ 07(Parameter setting)/ 08(RS485)/ 09(Option-1)/ 10(Option-2)/ 11(Option-3)/ 12(Pulse train input(internal))/ 13(Pulse train input(option))
PID4 set-point setting	[AJ-50]	-100.00 to 100.00(%) *3)	This is a set value when [AJ-47] set to 07.
PID4 feedback input source selection	[AJ-52]	00 to 08, 09 to 13	00(Not used)/ 01(Terminal[Ai1])/ 02(Terminal[Ai2])/ 03(Terminal[Ai3])/ 04(Terminal[Ai4])/ 05(Terminal[Ai5])/ 06(Terminal[Ai6])/ 08(RS485)/ 09(Option-1)/ 10(Option-2)/ 11(Option-3)/ 12(Pulse train input(internal))/ 13(Pulse train input(option))
PID4 proportional gain	[AJ-53]	0.0 to 100.0	Proportional gain
PID4 integral time constant	[AJ-54]	0.0 to 3600.0(s)	Integral gain
PID4 derivative gain	[AJ-55]	0.00 to 100.00(s)	Differential gain

*3) Data range varies according to [AJ-44],[AJ-45],[AJ-46] settings.

■ Input terminal function.

Function name	Terminal symbol	Data	Description
Disable PID2	[PID2]	043	Disables the PID2 function by turning ON the terminal function. When disabled, the set value of the selected PID2 set-point is used as the frequency reference.
PID2 integration reset	[PIDC2]	044	Clears the integral value of PID2 control.
Disable PID3	[PID3]	045	Disables the PID3 function by turning ON the terminal function. When disabled, the set value of the selected PID3 set-point is used as the frequency reference.
PID3 integration reset	[PIDC3]	046	Clears the integral value of PID3 control.
Disable PID4	[PID4]	047	Disables the PID4 function by turning ON the terminal function. When disabled, the set value of the selected PID4 set-point is used as the frequency reference.
PID4 integration reset	[PIDC4]	048	Clears the integral value of PID4 control.
PID output switching 1	[PIO1]	056	Switches PID output by a combination of PIO1 and PIO2.
PID output switching 2	[PIO2]	057	

■ Data monitor function.

Name	Code	Data range (unit)	Description
PID2 set-point setting or monitor	[FA-36]	-100.00 to 100.00(%) *1)	Displays the target value of PID2. Changeable when [AJ-07] = 07.
PID2 feedback value monitor	[db-36]	-100.00 to 100.00(%) *1)	Displays the feedback value of PID2.
PID2 output monitor	[db-55]	-100.00 to 100.00(%) *1)	Displays the output value of PID2.
PID2 deviation monitor	[db-56]	-200.00 to 200.00(%) *1)	Displays the deviation of PID2.
PID3 set-point setting or monitor	[FA-38]	-100.00 to 100.00(%) *2)	Displays the target value of PID3. Changeable when [AJ-27] = 07.
PID3 feedback value monitor	[db-38]	-100.00 to 100.00(%) *2)	Displays the feedback value of PID3.
PID3 output monitor	[db-57]	-100.00 to 100.00(%) *2)	Displays the output value of PID3.
PID3 deviation monitor	[db-58]	-200.00 to 200.00(%) *2)	Displays the deviation of PID3.
PID4 set-point setting or monitor	[FA-40]	-100.00 to 100.00(%) *3)	Displays the target value of PID4. Changeable when [AJ-47] = 07.
PID4 feedback value monitor	[db-40]	-100.00 to 100.00(%) *3)	Displays the feedback value of PID4.
PID4 output monitor	[db-59]	-100.00 to 100.00(%) *3)	Displays the output value of PID4.
PID4 deviation monitor	[db-60]	-200.00 to 200.00(%) *3)	Displays the deviation of PID4.

*1) Data range varies according to [AJ-04],[AJ-05],[AJ-06] settings.

*2) Data range varies according to [AJ-24],[AJ-25],[AJ-26] settings.

*3) Data range varies according to [AJ-44],[AJ-45], [AJ-46] settings.

■ Adjust PID2/PID3/PID4 control.

A

- When response is not stabilized in PID function operation, adjust according to the following procedure.
- Adjust respective PID gains for each PID2/PID3/PID4.



- If acceleration/deceleration time is set too long, following of output frequency will be delayed and control may not be successful. In this case, set the acceleration/deceleration time short.

Phenomenon ▶	Examples of measures
<ul style="list-style-type: none"> • Output response is slow and feedback value does not change swiftly even if PID target value was changed. 	<ul style="list-style-type: none"> • Increase PID proportional gain according to the correspondence table [1].
<ul style="list-style-type: none"> • Feedback value changes swiftly and is not stabilized. • Overshooting or hunting occurs. 	<ul style="list-style-type: none"> • Decrease PID proportional gain according to the correspondence table [1].
<ul style="list-style-type: none"> • Feedback value vibrates mildly. • It takes time for the operation to stabilize. 	<ul style="list-style-type: none"> • Increase PID integral gain according to the correspondence table [2].
<ul style="list-style-type: none"> • PID target value and feedback value do not match easily. 	<ul style="list-style-type: none"> • Decrease PID integral gain according to the correspondence table [2].
<ul style="list-style-type: none"> • Response is slow even if proportional gain was increased. • Small hunting occurs. 	<ul style="list-style-type: none"> • Increase PID differential gain according to the correspondence table [3].
<ul style="list-style-type: none"> • Response due to disturbance is large and it takes time until stabilization. 	<ul style="list-style-type: none"> • Decrease PID differential gain according to the correspondence table [3].

• Gain correspondence table

	[1] Proportional gain	[2] Integral gain	[3] Differential gain
PID2	[AJ-13]	[AJ-14]	[AJ-15]
PID3	[AJ-33]	[AJ-34]	[AJ-35]
PID4	[AJ-53]	[AJ-54]	[AJ-55]

■ PID2/PID3/PID4 changeable range limitation.



- PID output is restricted to a changeable range based on the target value.
- The limitation function of PID for which 0.00 was set for the following changeable range will be disabled.



- In the case of using this function, set the corresponding PID changeable range ([AJ-16]/[AJ-36]/[AJ-56]). Restriction will be set with the maximum speed as 100% (PID target value ± changeable range).

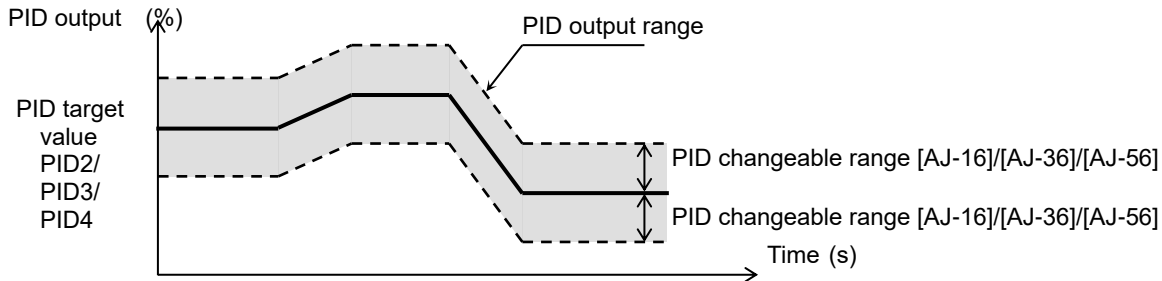

■ Parameters.

Name	Code	Data range (unit)	Description
PID2 output range	[AJ-16]	0.00 to 100.00(%)	Changeable range based on PID2 target value
PID3 output range	[AJ-36]	0.00 to 100.00(%)	Changeable range based on PID3 target value
PID4 output range	[AJ-56]	0.00 to 100.00(%)	Changeable range based on PID4 target value

■ PID2/PID3/PID4 reverse output.



- In normal PID control, the inverter does not output a negative value for frequency reference and limits at 0 Hz. If you select 02 (with reverse output) for each selection [AJ-01]/[AJ-21]/[AJ-41] of PID2/PID3/PID4, frequency reference can be output in a reverse direction, if the result of the corresponding PID calculation was negative.



- When [AJ-01]/[AJ-21]/[AJ-41] is set to 02 (with reverse output), the PID changeable range limit function [AJ-16]/[AJ-36]/[AJ-56] will be extended to the negative direction.

■ Parameters.

Name	Code	Data range (unit)	Description
PID2 enable	[AJ-01]	02	Enable (if command becomes negative, it outputs in a reverse direction)
PID3 enable	[AJ-21]		
PID4 enable	[AJ-41]		

■ PID2/PID3/PID4 integral value reset function [PIDC2]/[PIDC3]/[PIDC4].



- This function clears each integral value for each PID operation.
- In the case of turning ON the [PIDC2]/[PIDC3]/[PIDC4] terminal, do so when the corresponding PID is not in operation.



- Turning ON the [PIDC2]/[PIDC3]/[PIDC4] terminal during PID operation clears the integral value added to the PID output command and changes the PID output command value abruptly, resulting in an overcurrent or etc error.

■ PID2/PID3/PID4 disable function [PID2]/[PID3]/[PID4].



- Turning ON the corresponding terminal disables PID operation temporarily and performs output according to frequency reference.

- The target value for each PID is adopted in the frequency reference for each set point input source selection parameter. (In this case 100% set-point setting = maximum frequency setting.)

12.10.6 PID Output Signals

PID over deviation signals.

A

- Over deviation for each PID control signals are output when each PID deviation exceeds the each PID over deviation level.

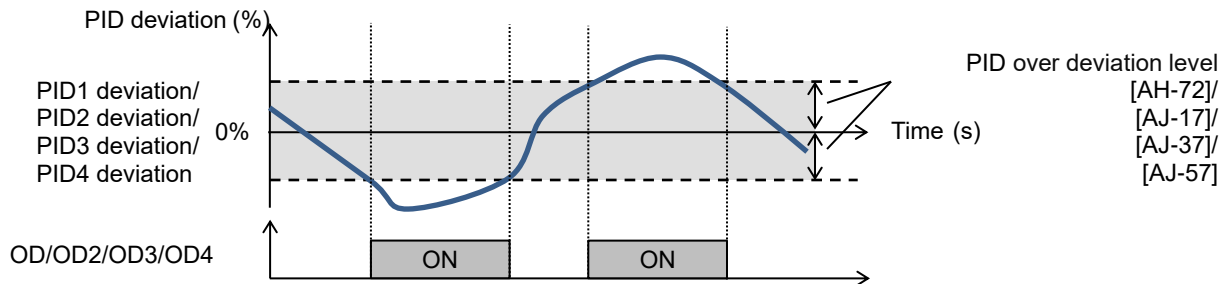

Parameter.

Name	Code	Data range (unit)	Description
PID1 over deviation level	[AH-72]	0.00 to 100.00(%)	045 [OD] signal output judgment level
PID2 over deviation level	[AJ-17]	0.00 to 100.00(%)	047 [OD2] signal output judgment level
PID3 over deviation level	[AJ-37]	0.00 to 100.00(%)	089 [OD3] signal output judgment level
PID4 over deviation level	[AJ-57]	0.00 to 100.00(%)	091 [OD4] signal output judgment level

Output signal function.

Function name	Terminal symbol	Data	Description
Deviation over for PID1 control	OD	045	Signal will be turned ON when the difference between PID target value and feedback value exceeds the range of PID1 deviation excessive level.
Deviation over for PID2 control	OD2	047	Signal will be turned ON when the difference between PID target value and feedback value exceeds the range of PID2 deviation excessive level.
Deviation over for PID3 control	OD3	089	Signal will be turned ON when the difference between PID target value and feedback value exceeds the range of PID3 deviation excessive level.
Deviation over for PID4 control	OD4	091	Signal will be turned ON when the difference between PID target value and feedback value exceeds the range of PID4 deviation excessive level.

PID feedback comparison signals.



- Feedback compare signals turn off when the feedback value exceeds the turn-on/off levels for each PID control. For details, see shown figure below.



- Set PID1 feedback to be OFF level \geq ON level. OFF operation will be prioritized when it is set to Off level $<$ ON level.
- Setting ON level/OFF level to be other than 0.00 starts outputting of a feedback comparison signal.

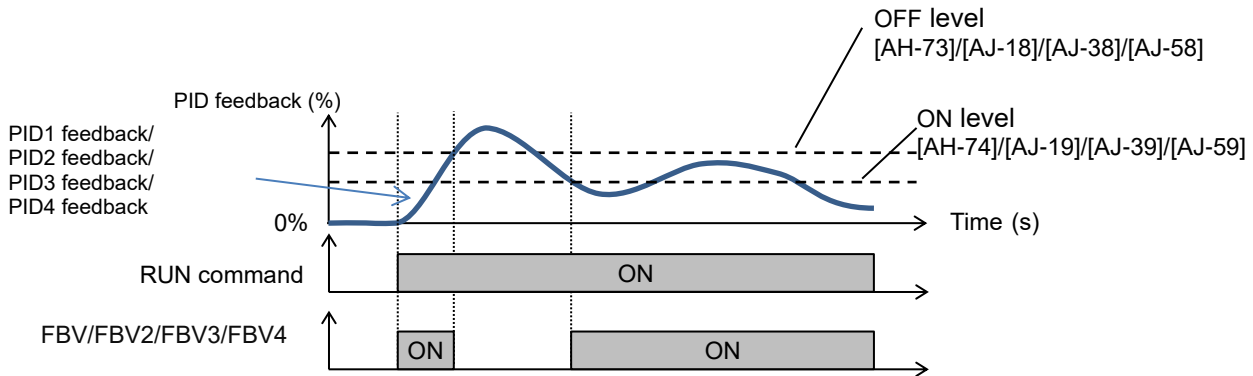

Parameters.

Name	Code	Data range (unit)	Description
Turn-off level for the PID1 feedback compare signal	[AH-73]	0.00 to 100.00(%)	FBV signal output OFF judgment level
Turn-on level for the PID1 feedback compare signal	[AH-74]	0.00 to 100.00(%)	FBV signal output ON judgment level
Turn-off level for the PID2 feedback compare signal	[AJ-18]	0.00 to 100.00(%)	FBV2 signal output OFF judgment level
Turn-on level for the PID2 feedback compare signal	[AJ-19]	0.00 to 100.00(%)	FBV2 signal output ON judgment level
Turn-off level for the PID3 feedback compare signal	[AJ-38]	0.00 to 100.00(%)	FBV3 signal output OFF judgment level
Turn-on level for the PID3 feedback compare signal	[AJ-39]	0.00 to 100.00(%)	FBV3 signal output ON judgment level
Turn-off level for the PID4 feedback compare signal	[AJ-58]	0.00 to 100.00(%)	FBV4 signal output OFF judgment level
Turn-on level for the PID4 feedback compare signal	[AJ-59]	0.00 to 100.00(%)	FBV4 signal output ON judgment level

Feedback comparison signal.

Function name	Terminal symbol	Data	Description
PID1 feedback comparison signal	[FBV]	046	PID1 feedback signal [FBV] OFF: Exceeded the OFF level. ON: Went below the ON level.
PID2 feedback comparison signal	[FBV2]	048	PID2 feedback signal [FBV2] OFF: Exceeded the OFF level. ON: Went below the ON level.
PID3 feedback comparison signal	[FBV3]	090	PID3 feedback signal [FBV3] OFF: Exceeded the OFF level. ON: Went below the ON level.
PID4 feedback comparison signal	[FBV4]	092	PID4 feedback signal [FBV4] OFF: Exceeded the OFF level. ON: Went below the ON level.

12.10.7 PID Unit Conversion

Unit conversion of target value and feedback value.

A

- This function enables to change the unit and scale of the following parameters.

PID1 display conversion parameter.

Name	Code
PID1 set-point 1 setting or monitor	[FA-30]
PID1 set-point 2 setting or monitor	[FA-32]
PID1 set-point 3 setting or monitor	[FA-34]
PID1 feedback value 1 monitor	[db-30]
PID1 feedback value 2 monitor	[db-32]
PID1 feedback value 3 monitor	[db-34]
PID1 target value monitor (after calculation)	[db-42]
PID1 feedback value monitor (after calculation)	[db-44]
PID1 set-point-1 setting	[AH-10]
PID1 multistage set-point 1 to 15	[AH-12] to [AH-40]
PID1 set-point 2 setting	[AH-44]
PID1 set-point 3 setting	[AH-48]

PID2 display conversion parameter.

Name	Code
PID2 set-point setting or monitor	[FA-36]
PID2 feedback value monitor	[db-36]
PID2 set-point setting	[AJ-10]

PID3 display conversion parameter.

Name	Code
PID3 set-point setting or monitor	[FA-38]
PID3 feedback value monitor	[db-38]
PID3 set-point setting	[AJ-30]

PID4 display conversion parameter.

Name	Code
PID4 set-point setting or monitor	[FA-40]
PID4 feedback value monitor	[db-40]
PID4 set-point setting	[AJ-50]

Unit conversion method.

The PID target value and feedback monitor value can be converted from "-100.00% to 100.00%" of the internal scale to the desired setting range and unit using the unit conversion parameter. In case [FA-30] PID1 set-point 1 setting or monitor, the factory default values are [AH-03] = "%", [AH-04] = 0, [AH-05] = 10000, [AH-06] = 2 (2 decimal places), so the setting range is -100.00 To 100.00%. (Right figure, solid line).

- In this setting, display descriptions of zero point and maximum point are set.
- An adjustment example is displayed at the bottom of this section.

Unit table.

No.	Unit	No.	Unit
00	non	31	cm
01	%	32	°F
02	A	33	l/s
03	Hz	34	l/min
04	V	35	l/h
05	kW	36	m3/s
06	W	37	m3/min
07	hr	38	m3/h
08	s	39	kg/s
09	kHz	40	kg/min
10	ohm	41	kg/h
11	mA	42	t/min
12	ms	43	t/h
13	P	44	gal/s
14	kgm2	45	gal/min
15	pls	46	gal/h
16	mH	47	ft3/s
17	Vdc	48	ft3/min
18	°C	49	ft3/h
19	kWh	50	lb/s
20	mF	51	lb/min
21	mVs/rad	52	lb/h
22	Nm	53	mbar
23	min ⁻¹	54	bar
24	m/s	55	Pa
25	m/min	56	kPa
26	m/h	57	PSI
27	ft/s	58	mm
28	ft/min		
29	ft/h		
30	m		

Notes on unit conversion.

In unit conversion, [AH-04] sets a conversion value of 0% (center point) for the internal scale "-100.00 to 100.00 (%)".

For example, if [AH-04] = 5000, [AH-05] = 10000, and [AH-6] = 2 (2 decimal places), the range after conversion is 0.00 to 100.00 as shown in the dotted line below.

In addition, when the input source is only + side, such as 0 to 10V of [Ai1] and [Ai2], the range after conversion is only "50.00 to 100.00" on the + side as shown below.

(See also examples 1 and 2 on the next page.)

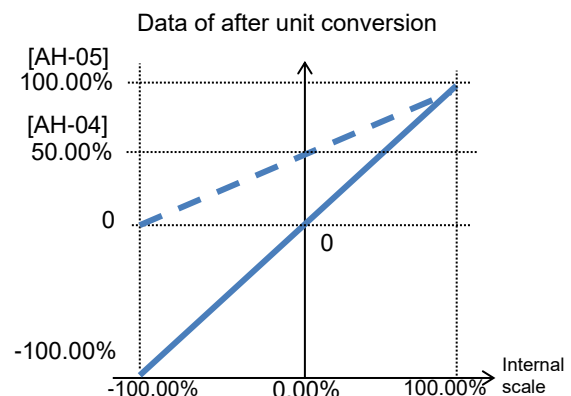

■ Parameter.

Name	Code	Data range (unit)	Description
Unit selection for PID1	[AH-03]	* Refer to the unit table in the previous page	Sets the unit of PID1 display conversion parameter.
PID1 adjustment (0%)	[AH-04]	-10000 to 10000	Sets the criteria of input 0% of PID1 display conversion parameter.
PID1 adjustment (100%)	[AH-05]	-10000 to 10000	Sets the criteria of input 100% of PID1 display conversion parameter.
PID1 adjustment (decimal point position)	[AH-06]	0	00000.
		1	0000.0
		2	000.00
		3	00.000
		4	0.0000
PID2 unit selection	[AJ-03]	* Refer to the unit table in the previous page	Sets the unit of PID2 display conversion parameter.
PID2 scale adjustment (0%)	[AJ-04]	-10000 to 10000	Sets the criteria of input 0% of PID2 display conversion parameter.
PID2 scale adjustment (100%)	[AJ-05]	-10000 to 10000	Sets the criteria of input 100% of PID2 display conversion parameter.
PID2 scale adjustment (decimal point position)	[AJ-06]	0	00000.
		1	0000.0
		2	000.00
		3	00.000
		4	0.0000
PID3 unit selection	[AJ-23]	* Refer to the unit table in the previous page	Sets the unit of PID3 display conversion parameter.
PID3 scale adjustment (0%)	[AJ-24]	-10000 to 10000	Sets the criteria of input 0% of PID3 display conversion parameter.
PID3 scale adjustment (100%)	[AJ-25]	-10000 to 10000	Sets the criteria of input 100% of PID3 display conversion parameter.
PID3 scale adjustment (decimal point position)	[AJ-26]	0	00000.
		1	0000.0
		2	000.00
		3	00.000
		4	0.0000
PID4 unit selection	[AJ-43]	* Refer to the unit table in the previous page	Sets the unit of PID4 display conversion parameter.
PID4 scale adjustment (0%)	[AJ-44]	-10000 to 10000	Sets the criteria of input 0% of PID4 display conversion parameter.
PID4 scale adjustment (100%)	[AJ-45]	-10000 to 10000	Sets the criteria of input 100% of PID4 display conversion parameter.
PID4 scale adjustment (decimal point position)	[AJ-46]	0	00000.
		1	0000.0
		2	000.00
		3	00.000
		4	0.0000

(Adjustment example 1)

If you want to display 0 to 10 VDC (0 to 100%) as 0.1 to 0.5 kPa in [db-30] when the voltage is feed-backed to the analog input 1 [Ai1]

- Unit [AH-03] = 56 (kPa), decimal point position [AH-06] = 2, zero point [AH-04] = 10, end point [AH-05] = 50

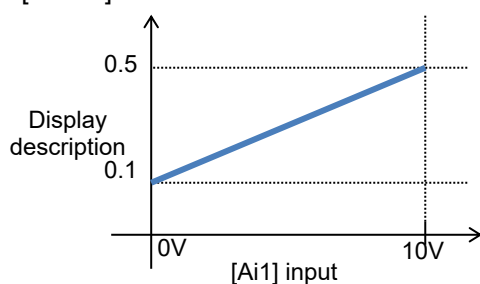

(Adjustment example 2)

If you want to display -10 to 10 VDC (-100 to 100%) as 0.1 to 0.5kPa in [db-30] when the voltage is feed-backed to the analog input 3 [Ai3]

- Unit [AH-03] = 56 (kPa), decimal point position [AH-06] = 2, zero point [AH-04] = 30, end point [AH-05] = 50

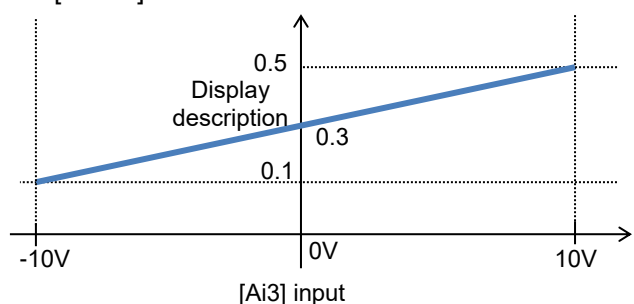

(Memo)

12.11 Perform Torque Control Suitable for the Load

12.11.1 How to Control the Output Torque

A

- There are the following two methods to control the output torque using an inverter:

(i) Using the torque limit function in the speed control mode.

- This is the control that limits the output torque of the motor when it exceeds the specified torque value during speed control mode. Even if the load condition changes, the output torque of the motor is limited by suppressing the output current.

The torque limit function in the speed control mode can be used when the Control mode selection [AA121] setting is:

- 08: Sensorless vector control (IM);
- 09: Sensorless vector control (IM) in zero Hz range;
- 10: Vector control with encoder (IM);

However, in 09 Zero-Hz range sensorless vector control (IM), the control for output high torque in around 0 Hz has priority.

(ii) Torque control mode with specify output torque.

This is the control that the output torque of the motor follows the specified torque reference. Even if the load condition changes, if the torque reference is constant, the output current is controlled so that the output torque of the motor is constant.

The torque control mode can be used when the control mode selection [AA121] setting is:

- 08: Sensorless vector control (IM);
- 10: Vector control with encoder (IM);.

Control mode	Torque limit function in the speed control mode	Torque control mode
Operation	The inverter output is controlled so that the output torque of the motor does not exceed the specified torque limit value.	The inverter output is controlled so that the output torque of the motor follows the torque reference.
Description	<ul style="list-style-type: none"> • Even if the load condition changes, the output torque of the motor is controlled so that it does not exceed the specified torque limit value. • When the load exceeds the torque limit, the motor speed will slow down accordingly. • It is used for applications that prevent excessive force from being applied, such as Extruder machines. 	<ul style="list-style-type: none"> • Regardless of the load condition, the output current is controlled so that the output torque of the motor follows the torque reference. As a result, the motor speed goes up and down. • In torque control mode, when the load is too small for the torque reference, the motor speed will continue to increase. Normally, the speed limit function is set to avoid such over speed errors. • It is used for applications that keep the output torque constant even when an external force that fluctuates irregularly is applied, such as a winder that wants to keep the tension constant.

12.11.2 Motor Control Response Gain Settings



- I want to switch the response of motor control by situation.
- I want to change the speed response by speed.
- I want to change the response gain depending on the speed that changes with the diameter, such as in a winding machine, etc.
- I want to set the gain based on the speed because inertia changes by speed.



- This switches control gain (ASR(Automatic Speed Regulator) gain) of motor control.
- In the control gain switch function, two types of PI gains are switched and applied by turning ON and OFF the input terminal function [CAS].

■ When [CAS] terminal switch [HA120] = 00.

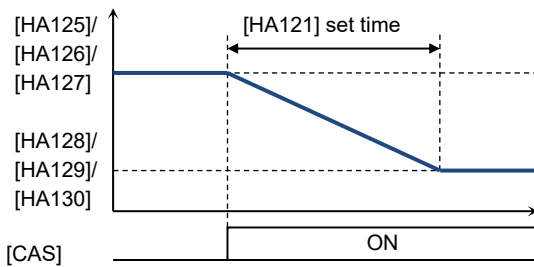

- When the gain is switched at the [PPI] terminal when using the control gain mapping function, the ASR gain mapping P control P-gain 2 [HA130] is applied at the ASR gain mapping intermediate speed 1 [HA122] or higher.
- In the case of using this function, 08:Sensorless vector control (IM), 09:Zero-Hz range sensorless vector control (IM), and 10:Vector control (IM) with encoder need to be selected in the [AA121] control method.
- In the case of using this function in SM (PMM) control, P gain is adopted.

- In the gain mapping function to be switched by setting, setting multiple control gains corresponding to the speed can change the gain with the speed change.

- The gains to be applied by switching of the [CAS] terminal are as follows.

Terminal function	[PPI]OFF	[PPI]ON
[CAS] OFF	ASR gain mapping P-gain 1 [HA125] ASR gain mapping I-gain 1 [HA126]	ASR gain mapping P control P-gain 1 [HA127]
[CAS] ON	ASR gain mapping P-gain 2 [HA128] ASR gain mapping I-gain 2 [HA129]	ASR gain mapping P control P-gain 2 [HA130]

■ In the case of switching by setting [HA120] = 01.

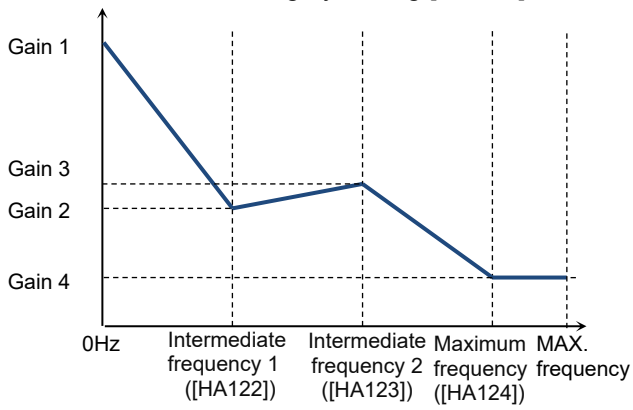

- The gains to be applied by switching of the control gain mapping function are as follows.

Speed	Applied gain	[PPI] OFF	[PPI] ON
Zero Hz	Gain 1	ASR gain mapping P-gain 1 [HA125] ASR gain mapping I-gain 1 [HA126]	ASR gain mapping P control P-gain 1 [HA127]
Intermediate frequency 1	Gain 2	ASR gain mapping P-gain 2 [HA128] ASR gain mapping I-gain 2 [HA129]	ASR gain mapping P control P-gain 2 [HA130]
Intermediate frequency 2	Gain 3	ASR gain mapping P-gain 3 [HA131] ASR gain mapping I-gain 3 [HA132]	
Maximum frequency	Gain 4	ASR gain mapping P-gain 4 [HA133] ASR gain mapping I-gain 4 [HA134]	

■ Parameters.

Name	Code	Data range (unit)	Description
ASR gain switching mode selection, 1st-motor	[HA120]	00	Switches gain 1 and 2 by the [CAS] terminal.
		01	Switches by speed based on the setting.
ASR gain switching time setting, 1st-motor	[HA121]	0 to 10000(ms)	Switches the gain over the set time when [CAS] gain is switched.
ASR gain mapping intermediate speed 1, 1st-motor	[HA122]	0.00 to 590.00(Hz)	Is a frequency for which the control gain 2 of the gain mapping function is applied.
ASR gain mapping intermediate speed 2, 1st-motor	[HA123]	0.00 to 590.00(Hz)	Is a frequency for which the control gain 3 of the gain mapping function is applied.
ASR gain mapping maximum speed, 1st-motor	[HA124]	0.00 to 590.00(Hz)	Is a frequency for which the control gain 4 of the gain mapping function.
ASR gain mapping P-gain 1, 1st-motor	[HA125]	0.0 to 1000.0(%)	Sets the P gain of PI control when the [CAS] terminal is OFF or the gain mapping is at zero speed.
ASR gain mapping I-gain 1, 1st-motor	[HA126]	0.0 to 1000.0(%)	Sets the I gain of PI control when the [CAS] terminal is OFF or the gain mapping is at zero speed.
ASR gain mapping P control P-gain 1, 1st-motor	[HA127]	0.0 to 1000.0(%)	Sets the P gain of P control when the [CAS] terminal is OFF or the gain mapping is at zero speed.
ASR gain mapping P-gain 2, 1st-motor	[HA128]	0.0 to 1000.0(%)	Sets the P gain of PI control when the [CAS] terminal is ON or the gain mapping intermediate speed is at 1.
ASR gain mapping I-gain 2, 1st-motor	[HA129]	0.0 to 1000.0(%)	Sets the I gain of PI control when the [CAS] terminal is ON or the gain mapping intermediate speed is at 1.
ASR gain mapping P control P-gain 2, 1st-motor	[HA130]	0.00 to 10.00	Sets the P gain of P control when the [CAS] terminal is ON or the gain mapping intermediate speed is at 1.
ASR gain mapping P-gain 3, 1st-motor	[HA131]	0.0 to 1000.0(%)	Sets the P gain of PI control when the gain mapping intermediate speed is at 2.
ASR gain mapping I-gain 3, 1st-motor	[HA132]	0.0 to 1000.0(%)	Sets the I gain of PI control when the gain mapping intermediate speed is at 2.
ASR gain mapping P-gain 4, 1st-motor	[HA133]	0.0 to 1000.0(%)	Sets the P gain of PI control at the gain mapping maximum speed.
ASR gain mapping I-gain 4, 1st-motor	[HA134]	0.0 to 1000.0(%)	Sets the I gain of PI control at the gain mapping maximum speed.
Input terminal function	[CA-01] to [CA-11]	063	Switches PI control and P control by the [PPI] terminal.
		064	Switches gains by the [CAS] terminal.

12.11.3 Drooping Control Operation



- I want to balance the output torque of each motor when one axis is driven by multiple motors and inverters.



- For example, if one axis is driven by two motors and inverters for load dispersing (eg, conveyor, traveling crane, etc.), switch the control gain (ASR(Automatic Speed Regulator) gain) of motor control from PI control to P control for one inverter. By doing so, the inverter automatically increases or decreases the output frequency to balance the load with the other one.
- In P control, decreasing the ASR gain mapping P control P-gain 1 [HA127], the (X) in the right figure will become large. Adjust the P control P gain according to the actual system.



- The drooping control can be used when the control mode selection [AA121] setting is:
 - 08: Sensorless vector control (IM);
 - 09: Sensorless vector control (IM) in zero Hz range;
 - 10: Vector control with encoder (IM);
- When selecting inverter to change to P control, it may be better to select an inverter that causes [E001] overcurrent error or [E007] overvoltage error when multiple inverters are driven by PI control. Actually, select an inverter that is changed to P control according to the your system, and adjust the P gain of that inverter.

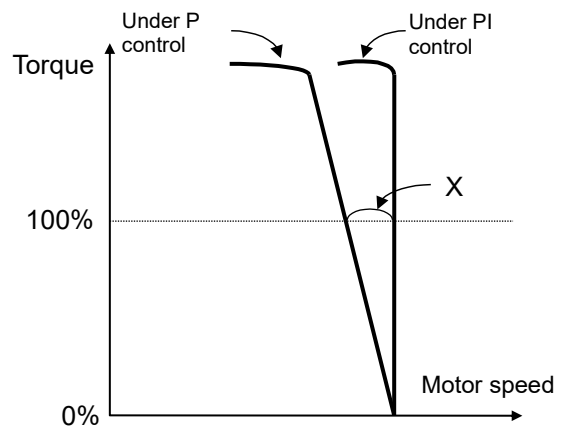

■ When turn ON/OFF [CAS] terminal ([HA120] = 00).

Terminal function	[PPI] OFF	[PPI] ON
[CAS] OFF	ASR gain mapping P-gain 1 [HA125] ASR gain mapping I-gain 1 [HA126]	ASR gain mapping P control P-gain 1 [HA127]
[CAS] ON	ASR gain mapping P-gain 2 [HA128] ASR gain mapping I-gain 2 [HA129]	ASR gain mapping P control P-gain 2 [HA130]

■ When use the Gain mapping function ([HA120] = 01).

Speed	Applied gain	[PPI] OFF	[PPI] ON
0Hz	Gain 1	ASR gain mapping P-gain 1 [HA125] ASR gain mapping I-gain 1 [HA126]	ASR gain mapping P control P-gain 1 [HA127]
Intermediate frequency 1	Gain 2	ASR gain mapping P-gain 2 [HA128] ASR gain mapping I-gain 2 [HA129]	ASR gain mapping P control P-gain 2 [HA130]
Intermediate frequency 2	Gain 3	ASR gain mapping P-gain 3 [HA131] ASR gain mapping I-gain 3 [HA132]	
Maximum frequency	Gain 4	ASR gain mapping P-gain 4 [HA133] ASR gain mapping I-gain 4 [HA134]	

■ Parameters.

Name	Code	Data range (unit)	Description
ASR gain switching mode selection, 1st-motor	[HA120]	00	Switches gain 1 and 2 by the [CAS] terminal.
		01	Switches by speed based on the setting.
ASR gain switching time setting, 1st-motor	[HA121]	0 to 10000(ms)	Switches the gain over the set time when [CAS] gain is switched.
ASR gain mapping intermediate speed 1, 1st-motor	[HA122]	0.00 to 590.00(Hz)	Is a frequency for which the control gain 2 of the gain mapping function is applied.
ASR gain mapping intermediate speed 2, 1st-motor	[HA123]	0.00 to 590.00(Hz)	Is a frequency for which the control gain 3 of the gain mapping function is applied.
ASR gain mapping maximum speed, 1st-motor	[HA124]	0.00 to 590.00(Hz)	Is a frequency for which the control gain 4 of the gain mapping function.
ASR gain mapping P-gain 1, 1st-motor	[HA125]	0.0 to 1000.0(%)	Sets the P gain of PI control when the [CAS] terminal is OFF or the gain mapping is at zero speed.
ASR gain mapping I-gain 1, 1st-motor	[HA126]	0.0 to 1000.0(%)	Sets the I gain of PI control when the [CAS] terminal is OFF or the gain mapping is at zero speed.
ASR gain mapping P control P-gain 1, 1st-motor	[HA127]	0.0 to 1000.0(%)	Sets the P gain of P control when the [CAS] terminal is OFF or the gain mapping is at zero speed.
ASR gain mapping P-gain 2, 1st-motor	[HA128]	0.0 to 1000.0(%)	Sets the P gain of PI control when the [CAS] terminal is ON or the gain mapping intermediate speed is at 1.
ASR gain mapping I-gain 2, 1st-motor	[HA129]	0.0 to 1000.0(%)	Sets the I gain of PI control when the [CAS] terminal is ON or the gain mapping intermediate speed is at 1.
ASR gain mapping P control P-gain 2, 1st-motor	[HA130]	0.00 to 10.00	Sets the P gain of P control when the [CAS] terminal is ON or the gain mapping intermediate speed is at 1.
ASR gain mapping P-gain 3, 1st-motor	[HA131]	0.0 to 1000.0(%)	Sets the P gain of PI control when the gain mapping intermediate speed is at 2.
ASR gain mapping I-gain 3, 1st-motor	[HA132]	0.0 to 1000.0(%)	Sets the I gain of PI control when the gain mapping intermediate speed is at 2.
ASR gain mapping P-gain 4, 1st-motor	[HA133]	0.0 to 1000.0(%)	Sets the P gain of PI control at the gain mapping maximum speed.
ASR gain mapping I-gain 4, 1st-motor	[HA134]	0.0 to 1000.0(%)	Sets the I gain of PI control at the gain mapping maximum speed.
Input terminal function	[CA-01] to [CA-11]	063	Switches PI control and P control by the [PPI] terminal.
		064	Switches gains by the [CAS] terminal.

12.11.4 Torque Limit Settings



- I want to limit torque not to be excessive.
- I want to perform contact positioning control when reaching the end of the system.
- I want to monitor the torque that the inverter limits.



- This limits torque when the speed is controlled.
- In the case of using [AA121] control method is 08:Sensorless vector control (IM), 09:Zero-Hz range sensorless vector control (IM) or 10: Vector control with encoder (IM), output torque of the motor can be limited.
- The torque limit function is set in [bA110].
- When a torque limiting signal is selected in output selection, the output terminal 022 [TRQ] torque limiting signal will be turned ON once the torque limit function above starts operation.



- If the torque limiting enable [TL] is set to an input terminal, the torque limit function set to [bA110] will be enabled, only when [TL] is turned ON. When it is OFF, the torque limit setting will be disabled and the torque limit value will be the maximum value.
- If the torque limiting enable [TL] is not set to an input terminal, the torque limit function set to the torque limit selection [bA110] will be enabled constantly.
- When using the torque limit function in the low speed range, use the overload limit function together.
- The torque reference value (100%) for this function is selected with the parameters [HC115] / [HC215]. (See "12.11.8 Torque Reference Settings for Torque Control" for details.)
Therefore, the output torque at that time varies depending on the combined motor. Please note that the absolute value of torque is not expressed.
- The torque limit function and related input terminal functions [TL] / [TRQ1] / [TRQ2] and output terminal [TRQ] / [OTQ] described in this chapter are effective function when the [AA121] control method is 08:Sensorless vector control (IM), 09:Zero-Hz range sensorless vector control (IM) or 10: Vector control with encoder (IM).

[1] Analog input mode

- It is a mode to set a torque limit value in all four quadrants states by applied voltage/current by setting the Ai1/Ai2/Ai3 terminal on the control terminal block in the torque limit selection [bA110].

■ Input to Ai1/Ai2 terminal.

0 to 10 (VDC) / 0 to 20 (mA) corresponding value
Torque limit value: 0.0 to 500.0(%)

■ Input to Ai3 terminal.

-10 to 10 (VDC) corresponding value
Torque limit value: -500.0 to 500.0(%)

- The setting of the ratio above can be changed by adjusting the analog input start end function. See "12.24.5 Analog Input Settings".

(e.g.) In the case of setting 0.0 to 50.0% to the torque limit value for 0 to 10 (VDC)/0 to 20 (mA) input as [Ai1],
To change the maximum torque limit value of [Ai1] from 500.0% to 50.0%, set [Cb-04] to 10.0%.
([Cb-03]=0.0,[Cb-04]=10.0,[Cb-05]=0.0,[Cb-06]=100.0)

[2] 4 Quadrant specific setting mode

- It is a mode to set respective torque limits 1 to 4 ([bA112] to [bA115]) in the four quadrants of forward powered, forward regenerative, reverse powered, and reverse regenerative.
- It will be enabled when the torque limit selection [bA110] = 07 (parameter setting) and the torque limiting parameters mode selection [bA111] = 00 (by each quadrant).
- The relationship of four quadrants and torque limits is shown in the figure below.

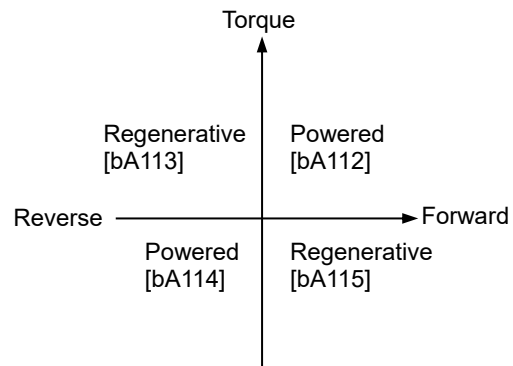

[3] Terminal switch mode

- The values of the torque limit 1 to 4 ([bA112] to [bA115]) are switched depending on the combination of the Torque limit selection bit 1/2 (061 [TRQ1]/ 062 [TRQ2]) assigned to the input terminals. The selected torque limit value is valid in all four quadrants.
- This mode is valid when the torque limit selection [bA110]=07 (parameter setting) and the torque limiting parameters mode selection [bA111]=01 (Switched by [TRQ1]/[TRQ2] terminals) are selected. The torque limit value selected depending on the status of [TRQ1] and [TRQ2] is shown in the right figure.

(e.g.) When the [TRQ1] is assigned to the input terminal 7 and the 062 [TRQ2] to the input terminal 8.

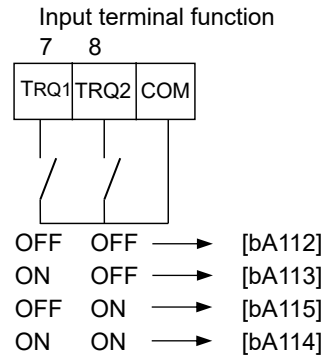

- Maintain acceleration/deceleration command of speed control when torque control is switched.

A

- If torque pulsation occurs at the time of canceling after torque limit operation, enabling the torque limit LADSTOP selection [bA116] may be effective.

■ Parameters.

Name	Code	Data range (unit)	Description
Torque limit selection, 1st-motor	[bA110]	00 to 11	00(Disable)/ 01(Terminal[Ai1])/ 02(Terminal[Ai2])/ 03(Terminal[Ai3])/ 04(Terminal[Ai4])/ 05(Terminal[Ai5])/ 06(Terminal[Ai6])/ 07(Parameter Setting)/ 08(RS485)/ 09(Option-1)/ 10(Option-2)/ 11(Option-3)
Torque limiting parameters mode selection, 1st-motor	[bA111]	00	Four Quadrant specific
		01	Switched by [TRQ1][TRQ2] terminals
Torque limit 1 (Forward drive), 1st-motor	[bA112]	0.0 to 500.00(%)	The torque limit function is operate when output torque exceeds this set value.
Torque limit 2 (Reverse regenerative), 1st-motor	[bA113]		
Torque limit 3 (Reverse drive), 1st-motor	[bA114]		
Torque limit 4 (Forward regenerative), 1st-motor	[bA115]		
Torque limit LADSTOP selection, 1st-motor	[bA116]	00	Disable
		01	Enable: retains frequency information when the torque limit is switched. (at the time of deceleration operation)

■ Input terminal function [CA-01] to [CA-11].

Function name	Terminal symbol	Data	Description
Torque limit enable	[TL]	060	Switches enable/disable of the torque limit function.
Torque limit selection bit 1	[TRQ1]	061	Is the torque limit command switch terminal 1.
Torque limit selection bit 2	[TRQ2]	062	Is the torque limit command switch terminal 2.

■ Output terminal [CC-01] to [CC-07].

Function name	Terminal symbol	Data	Description
Torque limited	[TRQ]	022	Signal turns ON when the torque limit function is enabled.

■ Output a signal when torque rises or drops.

A

- The output terminal 019 [OTQ] over torque signal will be turned ON when the torque output value [dA-17] exceeds [CE120] to [CE123].
- To change 019[OTQ] to an under torque signal, change the output terminal a/b[NO/NC] setting of the output terminal to which 019[OTQ] is assigned from 00 to 01.

■ Monitor torque limit value.

A

- The torque limit that switched by each setting and input terminal can be checked with the torque limit monitor [dA-16].

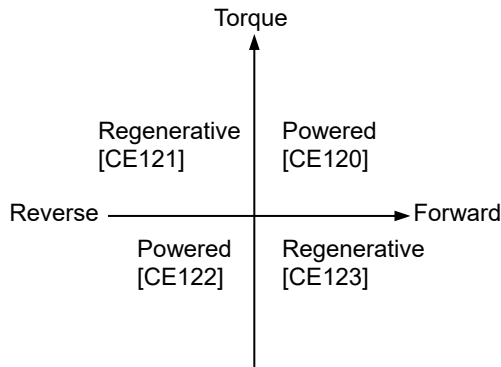

■ Parameters.

Name	Code	Data range (unit)	Description
Torque limit monitor	[dA-16]	0.0 to 500.0(%)	Displays the limit value of the torque limit function.
Output torque monitor	[dA-17]	-1000.0 to 1000.0(%)	Displays the output torque.
Over-torque level (Forward drive), 1st motor	[CE120]	0.0 to 500.0(%)	Turns On the [OTQ] output terminal function when the output torque exceeds respective levels.
Over-torque level (Reverse regenerative), 1st motor	[CE121]		
Over-torque level (Reverse drive), 1st motor	[CE122]		
Over-torque level (Forward regenerative), 1st motor	[CE123]		

■ Output terminal [CC-01] to [CC-07].

Function name	Terminal symbol	Data	Description
Over torque	[OTQ]	019	It turns ON when the output torque exceeds the Over-torque level settings.

12.11.5 Drive Multiple Motors with One Inverter

Q

- I want to output high torque when operating two induction motors with one inverter.
- I want to perform high torque multi-operation control.

A

- In the case of performing high torque multi-operation control, connect two motors with the same specification to one inverter and perform sensorless vector control (IM).
- Motor constant needs to be set as follows.



- In the case of operating different loads on two motors, the load fluctuation on one motor may influence the operation status of the other and cause inappropriate control. Make sure to operate them with a load that can be considered as one load.
- See "12.9 Select the Appropriate Control Mode for the Motor and Load " for adjustment method.

Motor base parameters.

Name	Code	Data range (unit)	Description
Async. Motor capacity setting, 1st-motor	[Hb102]	0.01 to 160.00 (kW) (P1-550L/P1-1320H or smaller) 0.01 to 500.00(kW) (P1-1600H or larger)	Sets a 2-fold capacity of a motor in high torque multi-operation.
Async. Motor number of poles setting, 1st-motor	[Hb103]	0 to 23 (2 to 48 poles)	Sets the number of poles per motor.
Async. Motor base frequency setting, 1st-motor	[Hb104]	1.00 to 590.00 (Hz)	Sets the base frequency per motor.
Async. Motor maximum frequency setting, 1st-motor	[Hb105]	1.00 to 590.00 (Hz)	Sets the maximum frequency per motor.
Async. Motor rated voltage, 1st-motor	[Hb106]	1 to 1000 (V)	Sets the rated voltage per motor.
Async. Motor rated current, 1st-motor	[Hb108]	0.01 to 10000.00(A)	Sets a 2-fold rated current of a motor in high torque multi-operation.

IM motor constant parameters.

Name	Code	Data range (unit)	Description
Async. Motor constant R1, 1st-motor	[Hb110]	0.000001 to 1000.000000(Ω)	Sets half of primary resistance of a motor in high torque multi-operation.
Async. Motor constant R2, 1st-motor	[Hb112]	0.000001 to 1000.000000(Ω)	Sets half of secondary resistance of a motor in high torque multi-operation.
Async. Motor constant L, 1st-motor	[Hb114]	0.000001 to 1000.000000(mH)	Sets half of leaked inductance value of a motor in high torque multi-operation.
Async. Motor constant I0, 1st-motor	[Hb116]	0.01 to 10000.00(A)	Sets a 2-fold non-load current value of a motor in high torque multi-operation.
Async. Motor constant J, 1st-motor	[Hb118]	0.00001 to 10000.00000(kg m^2)	Sets a 2-fold system inertia moment of a motor in high torque multi-operation.

Parameter.

Name	Code	Data range (unit)	Description
Control mode selection, 1st-motor	[AA121]	08: Sensorless vector control (IM) 09: Zero-Hz-range sensorless vector control (IM)	Uses the sensorless vector control function or Zero-Hz-range sensorless vector control.

12.11.6 Torque Bias Function Settings

Q

- I want to operate by adding torque reference temporarily for lifting up/down or like.
- I want to increase the starting torque reference when starting the motor.

A

- The torque bias function operates by enabling torque bias mode selection at the time of speed control.
- The torque bias function is enabled when the [AA121] control method is 08:Sensorless vector control (IM), 09:Zero-Hz range sensorless vector control (IM) or 10: Vector control with encoder (IM).
- The torque bias function operates in either speed control or torque control.
- When the 068 [TBS] torque bias enable function is set to the input terminal, the torque bias function will be enabled, only when [TBS] is turned ON. When it is OFF, the torque bias setting will be disabled and the torque addition will be 0.
- In the torque bias function, switching forward/reverse can switch the adding direction.

[1] When it is per the sign $[\pm]$ of [Ad-13] = 00
Regardless of the operation direction, torque will be added to the forward direction, when the torque bias value is (+), and to the reverse direction, when the torque bias is (-).

[2] When it is dependent on the operation direction [Ad-13] = 01
The sign of torque bias value and the direction of action of torque bias change based on the direction of RUN command.

- When the RUN command is Forward:
Adds torque in the same direction as the torque bias value.
- When the RUN command is Reverse:
Adds torque in the reverse direction as the torque bias value.



- The torque bias function increases current because torque reference is added.
- In the case of setting torque bias, values corresponding to analog inputs are as follows.

■ Input to Ai1/Ai2 terminal.

0 to 10 (VDC) / 0 to 20 (mA) corresponding value
Torque bias value: 0.0 to 500.0(%)

■ Input to Ai3 terminal.

-10 to 10 (VDC) corresponding value
Torque bias value: -500.0 to 500.0(%)

- The setting of the ratio above can be changed by adjusting the analog input start end function. See "12.24.5 Analog Input Settings".

(e.g.) In the case of setting 0.0 to 50.0% to the torque bias value for 0 to 10 (VDC) / 0 to 20 (mA) input as [Ai1],
To change the maximum bias value of [Ai1] from 500.0% to 50.0%, set [Cb-04] to 10.0%.
([Cb-03]=0.0,[Cb-04]=10.0,
[Cb-05]=0.0,[Cb-06]=100.0)

- The torque reference value (100%) for this function is selected with the parameters [HC115] / [HC215]. (See "12.11.8 Torque Reference Settings for Torque Control" for details.)

■ Monitoring of torque bias command value.

- Commanded torque bias value can be monitored on the torque bias setting or monitor [FA-16].
- In the case of [Ad-11] = 07, the setting can be changed on the [FA-16] monitor.
- The torque reference monitor (after calculation) [dA-15] displays the value with torque bias added to the present torque reference value.

■ Parameters.

Name	Code	Data range (unit)	Description
Torque bias input source selection	[Ad-11]	01 to 13,15	00(Disable)/ 01(Terminal[Ai1])/ 02(Terminal[Ai2])/ 03(Terminal[Ai3])/ 04(Terminal[Ai4])/ 05(Terminal[Ai5])/ 06(Terminal[Ai6])/ 07(Parameter Setting)/ 08(RS485)/ 09(Option-1)/ 10(Option-2)/ 11(Option-3)/ 12(Pulse train input(internal))/ 13(Pulse train input(option))/ 15(PID calc.)
Torque bias value setting	[Ad-12]	-500.0 to 500.0(%)	Adds a torque addition amount.
Torque bias polarity	[Ad-13]	00 (Per sign)	Regardless of the operation direction, torque will be added to the forward direction, when the value is (+), and to the reverse direction, when the value is (-).
		01 (Follow the revolution direction)	Changes the sign of the value and the direction of torque bias action into the RUN command.
Enable terminal [TBS]	[Ad-14]	00	Disable
		01	Enable
Torque bias setting or monitor	[FA-16]	-500.0 to 500.0(%)	Is the torque bias set monitor.
Torque reference monitor (after calculation)	[dA-15]	-1000.0 to 1000.0(%)	Is the torque reference monitor calculated set value and bias value.
Input terminal function	[CA-01] to [CA-11]	068	[TBS]: Can switch enable/disable of bias by the terminal ON/OFF switch when [TBS] is assigned and [Ad-14] = 01. ON: Enable/OFF: Disable

12.11.7 Switching Between Torque Control and Speed Control.



- I want to perform contact positioning control after moving objects.
- I want to use the system by switching speed control and torque control.



- If the torque reference changes in a step manner when switching from speed control to torque control, the current may rise instantaneously.



- In the case of operating by switching between torque control and speed control, turn ON and OFF the input terminal function 067 [ATR] function.
*) ATR(Automatic Torque Regulator).

■ Parameter.

Name	Code	Data range (unit)	Description
Switching time of speed control to torque control	[Ad-04]	0 to 1000(ms)	Switches to torque reference gradually based on the set time when switching speed control to torque control.

■ Input terminal function.

Name	Code	Data range (unit)	Description
Input terminal function	[CA-01] to [CA-11]	067	[ATR]: Permission of torque control

12.11.8 Torque Reference Settings for Torque Control

Q

- I want to control as such a certain torque is applied on the motor.
- I want to perform contact positioning control.
- I want to set a certain torque when winding machine or like.

A

- In the case of using [AA121] control method in sensorless vector control, sensorless vector control in the zero speed area, and sensor vector control, this drives the motor based on torque reference.
- This function can be used not only in speed control/pulse train position control but also in torque control. It can also be applied to a winding machine or like.
- When the torque bias function is used during torque control, the torque bias value is added to the torque reference.



- Because the speed under torque control is decided by the balance with load, set the speed limit input source selection at torque control [Ad-40] for prevention of runaway.
In the case of 07: Parameter setting, set the speed limit value setting [Ad-41]/[Ad-42].
- In the case of operating by torque control, assign 067 [ATR] to any of the input terminals. Turning ON the [ATR] terminal switches from speed control to torque control.
- Torque reference is the input value selected in the torque reference input source selection [Ad-01].
- The torque reference value (100%) for this function is selected with the parameters [HC115] / [HC215].

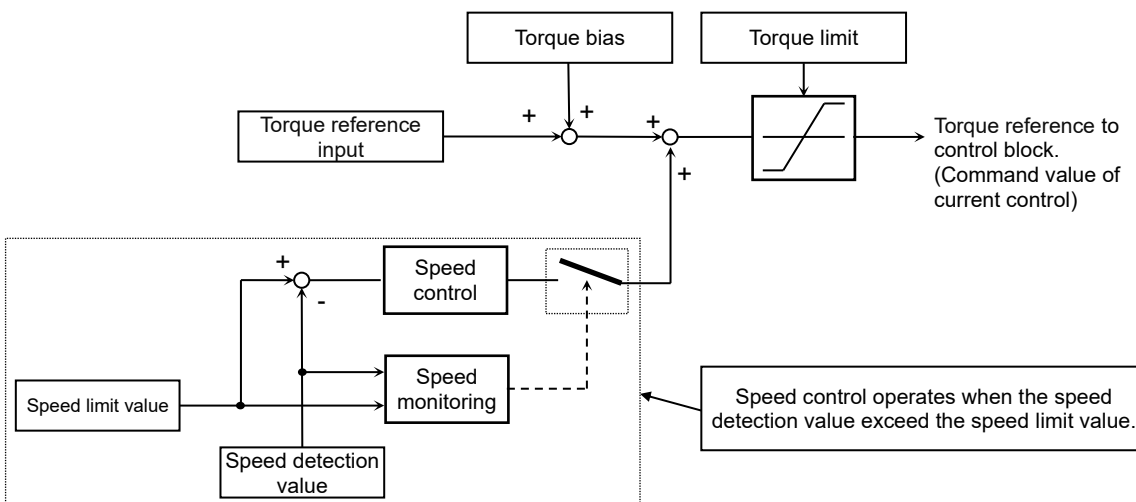

■ Parameters.

Name	Code	Data range (unit)	Description
Speed limit input source selection at torque control	[Ad-40]	01 to 13	01(Terminal[Ai1])/ 02(Terminal[Ai2])/ 03(Terminal[Ai3])/ 04(Terminal[Ai4])/ 05(Terminal[Ai5])/ 06(Terminal[Ai6])/ 07(Parameter Setting)/ 08(RS485)/ 09(Option-1)/ 10(Option-2)/ 11(Option-3)/ 12(Pulse train input(internal))/ 13(Pulse train input(option))
Speed limit at torque control (at Forward rotation)	[Ad-41]	0.00 to 590.00(Hz)	Sets frequency to limit in the forward rotation during torque control.
Speed limit at torque control (at Reverse rotation)	[Ad-42]	0.00 to 590.00(Hz)	Sets frequency to limit in the reverse rotation during torque control.

■ Monitoring of torque reference and output torque.



- The torque reference setting or monitor [FA-15] displays a current torque reference value.
- In the case of [Ad-01] = 07, the torque reference set value can be changed on the [FA-15] monitor.
- The torque reference monitor (after calculation) [dA-15] displays the value with torque bias added to the current torque reference.
- Current output torque can be monitored on the output torque monitor [dA-17].



- Output torque monitor [dA-17] is enabled when the [AA121] control method is 08:Sensorless vector control (IM), 09:Zero-Hz range sensorless vector control (IM) or 10: Vector control with encoder (IM).
- The torque reference value (100%) for torque related function is selected with the parameters [HC115] / [HC215].
The torque reference value (100%) for each selection is as shown in the table below.
(When 01 (current) is selected, it is equivalent to the SJ700 series, etc.)

■ Parameters.

Name	Code	Data range (unit)	Description
Torque reference input source selection	[Ad-01]	01 to 13,15	01(Terminal[Ai1])/ 02(Terminal[Ai2])/ 03(Terminal[Ai3])/ 04(Terminal[Ai4])/ 05(Terminal[Ai5])/ 06(Terminal[Ai6])/ 07(Parameter Setting)/ 08(RS485)/ 09(Option-1)/ 10(Option-2)/ 11(Option-3)/ 12(Pulse train input(internal))/ 13(Pulse train input(option))/ 15(PID calc.)
Torque reference value setting	[Ad-02]	-500.0 to 500.0(%)	Adds a torque addition amount.
Polarity selection for torque reference	[Ad-03]	00 (Per sign)	Regardless of the operation direction, torque will be added to the forward direction when the value is (+), and to the reverse direction when the value is (-).
		01 (Follow the revolution direction)	Changes the sign of value and the direction of torque bias action based on the RUN command direction.
Torque reference monitor (after calculation)	[dA-15]	-1000.0 to 1000.0(%)	It is the torque reference monitor calculated set value and bias value.
Output torque monitor	[dA-17]	-1000.0 to 1000.0(%)	Displays the output torque.
Torque reference setting or monitor	[FA-15]	-500.0 to 500.0(%)	It is the torque reference setting or monitor.
Torque conversion method selection, 1st-motor	[HC115]	00(Torque)/ 01(Current)	Select the 100% reference value of the parameter setting for torque. 00(Torque):Calculate the torque reference value (100%) as follows. Torque reference value = 79.58 x motor capacity x number of poles / base frequency (Example)Torque reference value = 79.58 × 5.5 (kW) × 4 (P) / 50 (Hz) ≒ 35Nm 01(Current):The torque reference value (100%) is the motor output torque at the rated current output (same as SJ700).

■ Input terminal function.

Item	Parameter	Data	Description
Input terminal function	[CA-01] to [CA-11]	067	Torque reference input approval [ATR]

(Memo)

12.12 Adjustments for Motor

Electromagnetic Sound Noise.

Electrical Noise.

Heat Generation of Inverter

12.12.1 Adjusting Carrier Frequency



- I want to reduce the electromagnetic sound noise from the motor.
- I want to reduce the electrical noise from the inverter.
- I want to suppress the heat generated in the inverter.
- I want to suppress the leakage current.



- Depend on setting of [Ub-03] Load specifications, the carrier frequency setting will be automatically restrained.
- To increase the carrier frequency setting, output current derating is required. For details on derating, see "20.4 Current Derating".
- When the induction motor (IM) is driven and the control mode selection [AA121] is 03([V/f] Auto torque boost (IM)) or 08(Sensorless vector control (IM)) or 09(Zero-Hz-range sensorless vector control (IM)), set the carrier frequency to 2.0 kHz or higher.



- The carrier frequency is the frequency at which the element that controls the inverter output changes.
- The carrier frequency can be changed using the [bb101] setting.
- It is also effective in avoiding resonance of mechanical systems and motors.

- When the control mode selection [AA121] is 11(Synchronous start type sensorless vector control(SM/PMM)) or 12(IVMS start type sensorless vector control (SM/PMM)), the carrier frequency setting is recommended to be 8.0kHz or higher. Please contact the PM motor manufacturer for details.
- The carrier frequency should be set to 10 times or higher of the Motor maximum frequency ([Hb105] for IM, [Hd105] for SM (PMM)).
(Ex.) When [Hb105] = 60 Hz, [bb101] = 0.6 kHz (600 Hz) or higher
- The current derating characteristics differ depending on the model and the load type selection ([Ub-03]), so refer to "20.4 Current Derating" to set an appropriate carrier frequency.

Carrier frequency and its extent of the effect.

Carrier frequency	Low	High
Motor electromagnetic sound noise	Loud	Quiet
Electrical noise	Low	High
Inverter heat generation	Little	Much
Leakage current	Low	High
Inverter output voltage waveform example (PWM output)	<p>Carrier frequency: Low</p>	<p>Carrier frequency: High</p>

Parameters.

Name	Code	Data range (unit)	Description
Carrier frequency setting, 1st-motor	[bb101]	P1-550L / P1-550H or smaller [Ub-03]=02(ND): 0.5 to 16.0 (kHz) [Ub-03]=01(LD): 0.5 to 12.0 (kHz) [Ub-03]=00(VLD): 0.5 to 10.0 (kHz) P1-750H or larger [Ub-03]=02(ND): 0.5 to 10.0 (kHz) [Ub-03]=01(LD): 0.5 to 8.0 (kHz) [Ub-03]=00(VLD): 0.5 to 8.0 (kHz)	Changes the carrier frequency.

12.12.2 Automatic Reduction of Carrier Frequency

Q

- I want to lower the carrier frequency automatically according to the current flowing to the inverter output.
- I want to lower the carrier frequency automatically according to the inverter temperature.

A

- The automatic carrier frequency reduction selection can be changed using the [bb103] setting.
- The higher the inverter carrier frequency is, the more the temperature inside the inverter tends to increase.
- The Automatic carrier frequency reduction function reduces life degradation of the elements by lowering the carrier frequency automatically according to the output current or temperature.

!

- When the automatic carrier frequency reduction function is activated, the electromagnetic noise of the motor changes.
- If the carrier frequency [bb101] is 2.0 kHz or lower, this function will not be activated.
- The carrier frequency change rate is 2 kHz per second while the inverter is in running.
- When the automatic carrier frequency reduction function is activated, the electromagnetic sound noise generated by the motor changes slowly.

■ Parameters.

Name	Code	Data range (unit)	Description
Automatic carrier reduction selection, 1st-motor	[bb103]	00	Follows the carrier frequency [bb101] setting.
		01	Reduces the carrier frequency according to the inverter output current.
		02	Reduces the carrier frequency according to the inverter temperature.

- Output current-dependent ([bb103] = 01).
 - Carrier frequency reduction starts once the current exceeds a certain value to the rated current.
 - When the current decreases, the carrier frequency is automatically regained.

- Cooling fin temperature-dependent ([bb103] = 02).
 - Carrier frequency reduction starts once the temperature of the internal output element exceeds a certain value.
 - When the temperature lowers, the carrier frequency is automatically regained.

[1-1] 200V/400V class 55kW or lower models

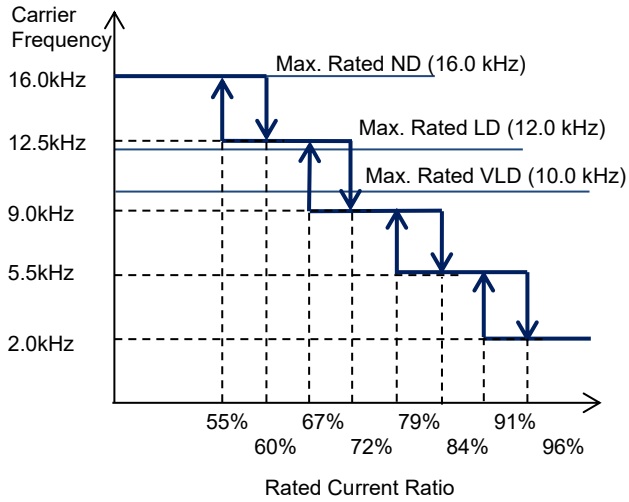

[2-1] 200V/400V class 55kW or lower models

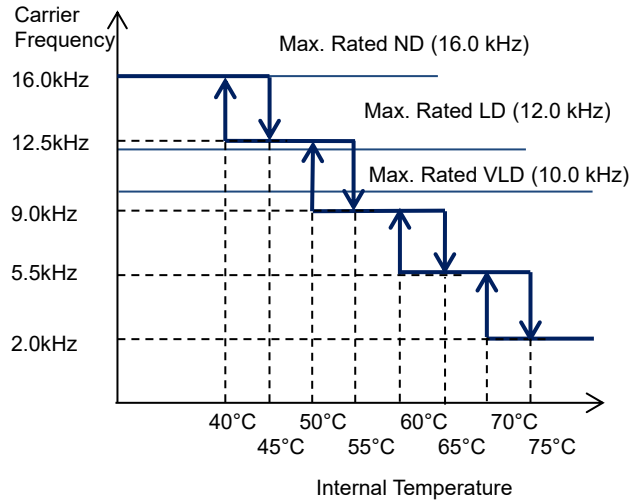

[1-2] 400V class 75kW or higher models.

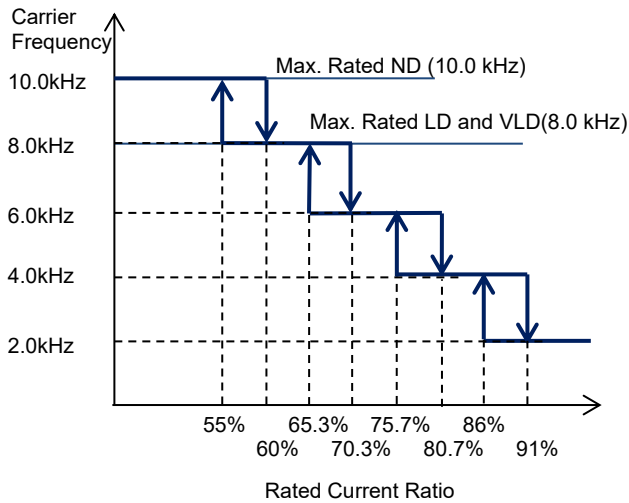

[2-2] 400V class 75kW or higher models.

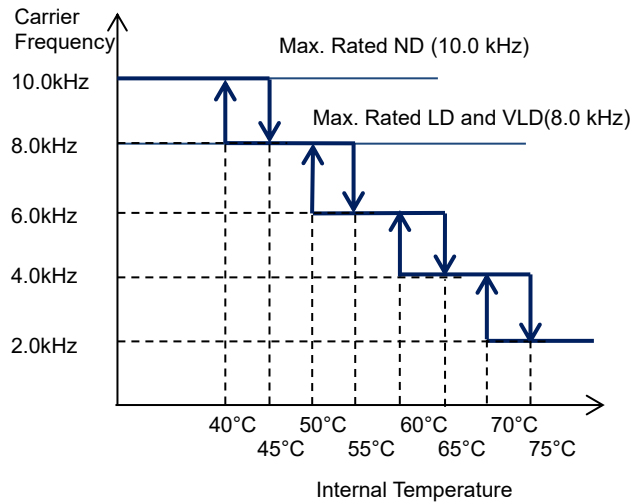

12.12.3 Reduction of Motor Electromagnetic Sound Noise

Q

- I want to lower the electromagnetic sound noise of motor produced by the carrier frequency.

A

- Sprinkle carrier pattern selection can be changed using the [bb102] setting.
- The inverter carrier frequency is about the same as when output at 3 kHz.

!

- Changing the sprinkle carrier pattern selection cuts the electromagnetic sound noise of a certain area and changes the electromagnetic sound noise of the motor.
- The electromagnetic sound noise reduction effect does not depend on the set value. Check with the combination with the using motor. Also, depending on the motor characteristics, it may not be effective.

■ Parameters.

Item	Parameter	Data	Description
Sprinkle carrier pattern selection, 1st-motor	[bb102]	00	Disabled (Follows other carrier frequency setting)
		01	Pattern 01
		02	Pattern 02
		03	Pattern 03

12.13 Functions to Prevent Trips or Restart on Trips

12.13.1 Restriction to Avoid Over-Load

Q

- I want to avoid over load by lowering the output frequency.
- I want to prevent stall.
- I want to accelerate while suppressing the motor current.
- I want to prevent overcurrent tripping caused by sudden fluctuation of load.

!

- If the overload restriction action time is set too short, an overvoltage error may occur due to the regenerative energy from the motor due to the automatic deceleration of this function.
- If this function is activated during acceleration and the frequency does not reach the target frequency, the situation can be improved with the adjustments shown below.
 - Make the acceleration time longer
 - Adjust the torque boost
 - Increase the overload limit level

A

- Set the overload restriction 1 mode selection [bA122] to any value other than 00, and the output frequency automatically lowers according to overload limit time once the output current reaches the overload restriction 1 active level [bA123].
 - When [bA122] = 01, the output current is monitored during acceleration or at constant speed. It limits overload when the moment of inertia increases during acceleration or the motor speed rapidly accelerate.
 - When [bA122] = 02, the output current is monitored only at constant speed. It prevents overloading caused by sudden load fluctuation at constant speed without decelerating during acceleration.
 - When [bA122] = 03, the output current is monitored during acceleration or at constant speed. In addition to the operation with [bA122] = 01, it accelerates to prevent overloading when regenerative load is applied at constant speed.
- The overload restriction 1 action time [bA124] corresponds to the acceleration time from 0Hz to the maximum frequency as shown in the figure below.
 - If this function is activated while the inverter is accelerating, the acceleration time will be longer than the set time.

■ Operation example.

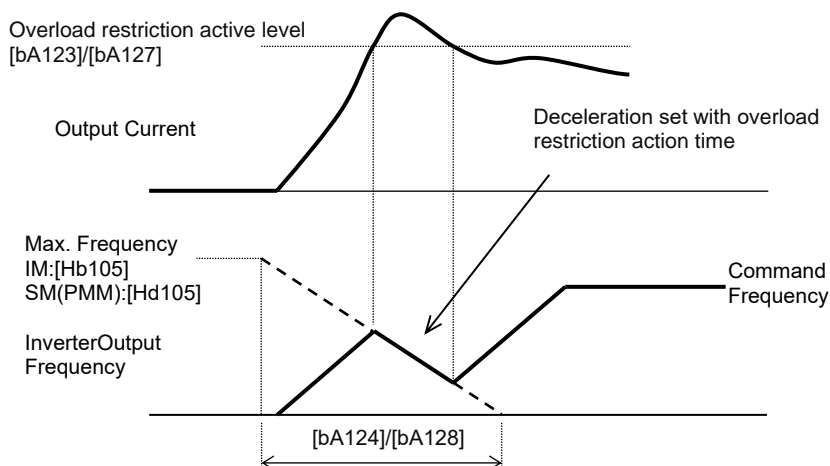

Q

- I want to switch the overload limit function with terminal input.
- I want to switch the overload limit level according to the load since the load weight differs from situation to situation.

A

- Two overload restriction functions can be set with [bA122] to [bA124] and [bA126] to [bA128].
- Overload restriction 1 and overload restriction 2 are switched by input terminal function 038 [OLR]. When [OLR] is ON, the overload restriction 2 is valid.

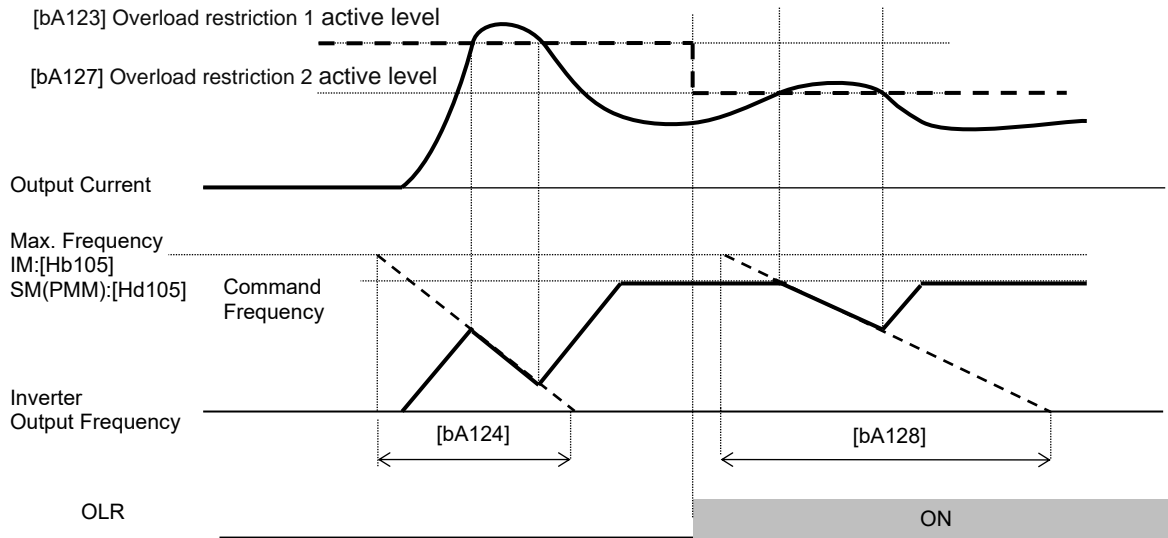

■ Parameters.

Name	Code	Data range (unit)	Description
Overload restriction 1 mode selection, 1st-motor	[bA122]	00	Disabled
		01	Enabled during acceleration and at constant speed
		02	Enabled at constant speed
Overload restriction 2 mode selection, 1st-motor	[bA126]	03	Enabled during acceleration and at constant speed (Speed increases during regeneration)
Overload restriction 1 active level, 1st-motor	[bA123]	Inverter rated current × (0.2 to 2.0) (A)	Overload restriction function is activated when the output current exceeds this set value.
Overload restriction 2 active level, 1st-motor	[bA127]		
Overload restriction 1 action time, 1st-motor	[bA124]	0.10 to 3600.00(s)	Acceleration/Deceleration time when exceeded the overload restriction level.
Overload restriction 2 action time, 1st-motor	[bA128]		

■ Input terminal function.

Item	Parameter	Data	Description
Input terminal function	[CA-01] to [CA-11]	038	[OLR] Overload restriction selection OFF: Overload limit 1 enabled. ON: Overload limit 2 enabled.

12.13.2 Restriction to Avoid Over-Current



- I want to avoid over current trip occurs due to impact load.
- I want to avoid tripping when the current increases for a moment.
- I want to accelerate while suppressing the motor current.
- I want to prevent tripping caused by sudden fluctuation of load.



- Disable this function for elevators, cranes or like. Suppressing the current causes insufficient torque, which may result in a slip down of the hanging load.
- The overcurrent tripping may take place even if this function is enabled if the current increases sharply due to shock load, etc.
- This function will be automatically enabled during DC braking.



- When the Overcurrent suppression enable[bA120] is set to 01, the overcurrent suppression function is enabled.
- This function suppresses the overcurrent caused by steep current increase due to sudden acceleration, etc.
- When the overcurrent suppression function is enabled, the overcurrent suppression function will be activated if the motor current exceeds the set value [bA121] due to a momentary current increase.

Parameters.

Name	Code	Data range (unit)	Description
Overcurrent suppression enable, 1st-motor	[bA120]	00	Disabled
		01	Enabled (Overcurrent suppression is activated.)
Overcurrent suppression level, 1st-motor	[bA121]	Inverter rated current × (0.0 to 2.0) (A)	Sets the operation level of the overcurrent suppression function.
OC-suppress level at active frequency matching	[bb-46]	Inverter rated current × (0.0 to 2.0) (A)	Sets the operation level of the overcurrent suppression function when activated active frequency matching.* 1)

*1) See "12.14.4 Starting with Active Frequency matching" for details.

12.13.3 Suppress Over-Voltage by Controlling Output Frequency

Q

- I want to avoid overvoltage errors when decelerating the motor.
- I want to decelerate the motor by automatically extending the deceleration time.
- I want to prevent overvoltage error by increasing the frequency when regenerative load is applied.

A

- The overvoltage suppression function can be enabled by setting [bA140].
- The overvoltage suppression function will be activated when the internal DC bus voltage (P-N voltage) of the inverter main circuit capacitor exceeds the value set by the Overvoltage suppression active level [bA141].

!

- When this function is enabled, the actual deceleration time may get longer than the set value.
- When using this function, it may take long time before the motor stops depending on the motor load moment of inertia.
- Depending on the deceleration rate or load status, the overvoltage tripping may be triggered even if this function is enabled.
- Set [bA141] to be receiving voltage $\times \sqrt{2} \times 1.1$ or higher.
If a value lower than the PN voltage during operation is set in [bA141], the motor may not be able to stop.

Parameters.

Name	Code	Data range (unit)	Description
Overvoltage suppression enable setting, 1st-motor	[bA140]	00	Disabled
		01	Constant DC bus voltage control (In deceleration stop).
		02	Overvoltage avoidance by acceleration (only in deceleration)
		03	Overvoltage avoidance by acceleration (In constant and deceleration)
Overvoltage suppression active level, 1st-motor	[bA141]	200 V class: 330.0 to 400.0 (VDC) 400 V class: 660.0 to 800.0 (VDC)	Sets the level at which the overvoltage suppression function starts.
Overvoltage suppression active time, 1st-motor	[bA142]	0.00 to 3600.00 (s)	Acceleration time when the overvoltage suppression function is activated.
Constant DC bus voltage control P gain, 1st-motor	[bA144]	0.00 to 5.00	Proportional gain of PI control for constant DC bus voltage control.
Constant DC bus voltage control I gain, 1st-motor	[bA145]	0.00 to 150.00 (s)	Integral gain of PI control for constant DC bus voltage control.

■ Constant DC bus voltage control [bA140] = 01.

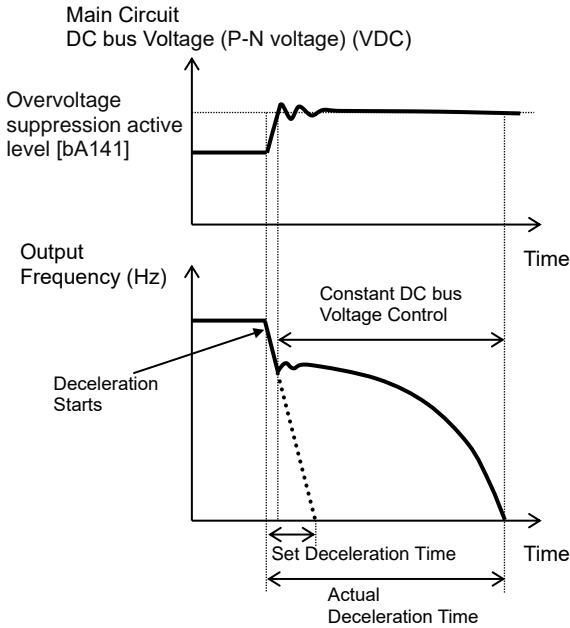

- When [bA140] is 01, PI control is performed so that the internal DC bus voltage (P-N voltage) will be constant.
- Setting the constant DC bus voltage control P gain [bA144] to be large will accelerate the response. However, setting it to be too large will dissipate the control, tending to cause tripping.
- Setting the constant DC bus voltage control I gain [bA145] to be short will accelerate the response. However, setting it to be too short will tend to cause tripping.
- If the internal DC bus voltage increases when [bA140] is 02 or 03, acceleration control is performed.
- The acceleration control accelerates to the maximum frequency setting according to the overvoltage suppression active time [bA142]. After the acceleration, it decelerates to the target value according to the normal deceleration time.



- If the overvoltage suppression active time [bA142] is set to be too short, it accelerates more than decelerating and may prevent the motor from stopping. In this case, increase the setting of the overvoltage suppression active level [bA141].

■ Overvoltage avoidance by acceleration (only in deceleration) [bA140] = 02.

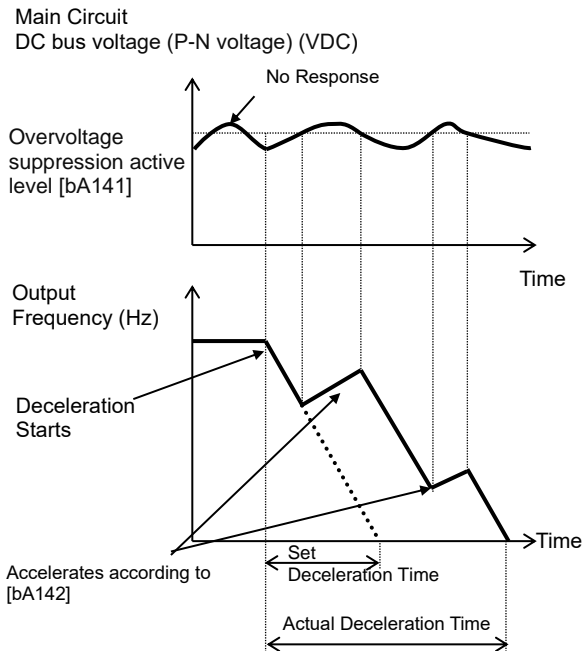

■ Overvoltage avoidance by acceleration (In constant and deceleration) [bA140] = 03.

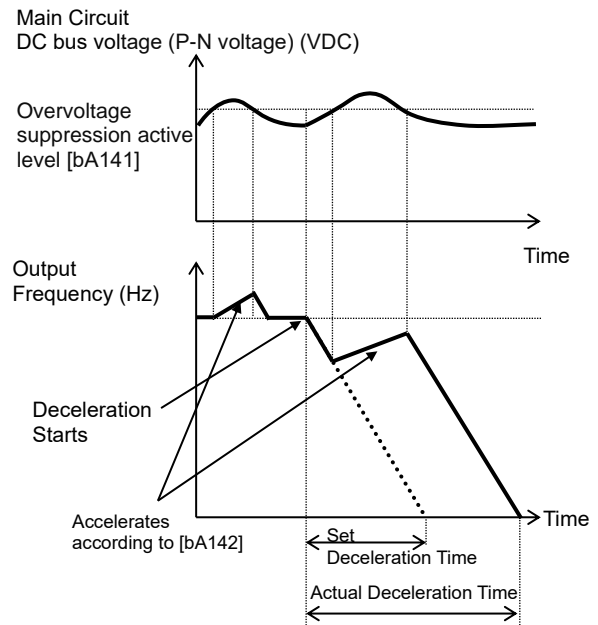

12.13.4 Suppress Over-Voltage by Controlling Output Voltage

Q

- I want to avoid overvoltage errors when decelerating the motor.
- I want to decelerate the motor by automatically increasing the output voltage according to the regenerative energy during deceleration.
- I want to prevent overvoltage error by increasing the output voltage when regenerative load is applied.

A

- This function can be enabled by the Over-magnetization function selection [bA146].
- The over magnetization function increases motor loss and reduces regenerated energy to suppress overvoltage and prevent trips.

!

- When this function is enabled, the current may increase as the output voltage increases.
- When using this function, the motor will be over magnetization and the heat generated by the motor may increase.
- Depending on the deceleration rate or load status, the overvoltage tripping may be triggered even if this function is enabled.
- This function works in V/f control (constant torque characteristics), V/f control (reducing torque characteristics), and free V/f control. ([AA121]=00,01,02,04,05,06).

■ Parameters.

Name	Code	Data range (unit)	Description
Over-magnetization function selection, 1st-motor	[bA146]	00	Disabled
		01	Always enable
		02	At deceleration only
		03	Operation at setting level
		04	Operation at setting level at deceleration only
Over-magnetization function output filter time constant, 1st motor	[bA147]	0.00 to 1.00 (s)	Filter time constant applied to the over magnetization output.
Over-magnetization function voltage gain, 1st-motor	[bA148]	50 to 400 (%)	Gain for the over magnetization output voltage.
Over-magnetization function level setting, 1st-motor	[bA149]	200 V class: 330.0 to 400.0 (VDC) 400 V class: 660.0 to 800.0 (VDC)	The level at which the over magnetization function starts its operation.

- Always enable [bA146] = 01.
- Always activated according to the P-N voltage.

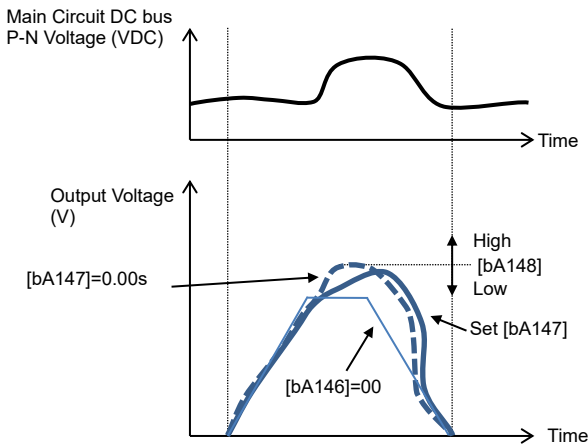

- At deceleration only [bA146] = 02.
- Operates according to the P-N voltage during deceleration.

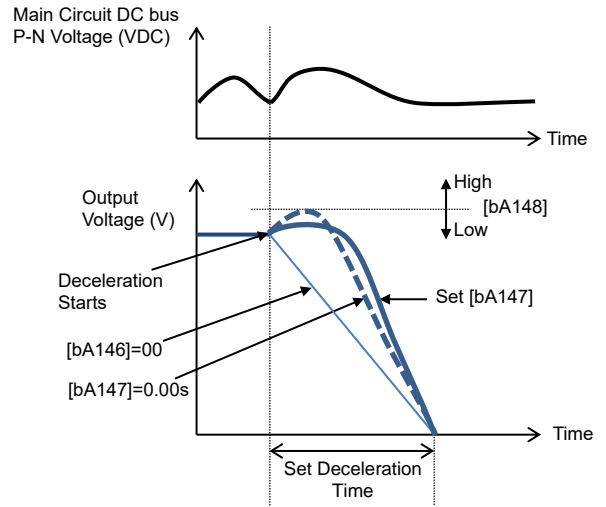

- Operation at setting level [bA146] = 03.
- Activated when the P-N voltage exceeds the set level.

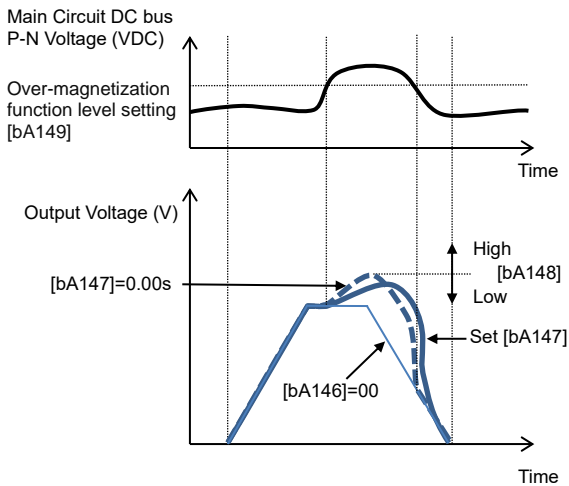

- Operation at setting level at deceleration only [bA146] = 04.
- Activated when the P-N voltage exceeds the set level only during deceleration.

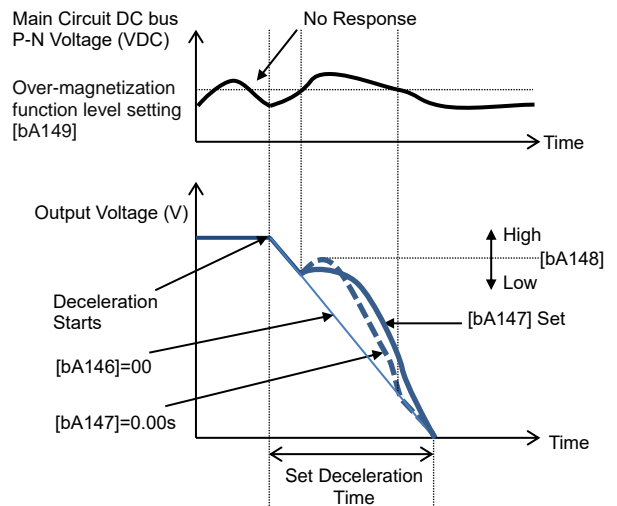

12.13.5 Suppress Over-Voltage with Braking Resistor



- I want to avoid overvoltage errors when decelerating the motor.
- I want to avoid overvoltage errors due to regenerative load.
- I want to use the motor for applications in which it is rapidly decelerated.
- I want to use it for unwinding equipment.



- Suppresses overvoltage errors by using braking resistors. In this case, make settings related to the built-in braking circuit (BRD).
- This function is to consume the regenerative energy from the motor as heat using the external resistor.

■ Operation rate.

The inverter will trip when the operation rate exceeds the use rate.

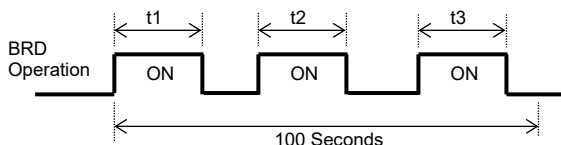

$$\text{Operation Rate (\%)} = \frac{(t1+t2+t3)}{100 \text{ Seconds}} \times 100$$

■ Parameters.

Name	Code	Data range (unit)	Description
Dynamic brake use ratio	[bA-60]	0.0 to 10.0× [[bA-63]/(minimum resistor)] ² (%) (Max. setting value is 100%) *1)	If set to 0.0, the BRD function is not work. If the setting is other than 0.0 and the BRD load rate monitor [dA-41] exceeds this set value, the inverter is tripped with [E006] Braking resistor overload error.
Dynamic brake activation selection	[bA-61]	00	Disabled
		01	Enabled (Disable while being stopped)
		02	Enabled (Enabled while being stopped)
Dynamic brake activation level	[bA-62]	200 V class: 330.0 to 400.0 (VDC) 400 V class: 660.0 to 800.0 (VDC)	The ON level at which the BRD is activated.
Dynamic brake resistor value	[bA-63]	Minimum resistance to 600 (Ω) *1)	Setting the BRD resistance to be connected automatically sets the maximum value for [bA-60].

*1) The minimum resistance value depends on the inverter model.

■ Monitoring.

Name	Code	Data range (unit)	Description
BRD load rate monitor	[dA-41]	0.00 to 100.00(%)	Displays the load rate of braking resistor.



- You can also use the optional BRD unit instead of using the built-in braking circuit (BRD). When using the BRD unit, it is not necessary to set the parameters below.
- The BRD ON level is the level setting for the main circuit DC smoothing capacitor inside the inverter. It needs to be set to a value exceeding the input voltage times $\sqrt{2}$.
- For the minimum resistance value that can be connected, refer to "Chapter 20 Specifications".

12.13.6 Restarting After Under Voltage

Q

- I want to continue driving the inverter even if the main power is cut off for a moment.
- I want to match the inverter output frequency to the motor speed and restart when recovering from under voltage.

A

- When the main power supply (R, S, T) fails, you can select either tripping ([bb-21] = 00) or restarting ([bb-21] ≠ 00) when power supply recovery.
- If the input power supply to the inverter is separately to main power supply (R, S, T) and control power supply (R0, T0), the restart function operates depending on the the main power supply (R, S, T).

!

- If the input power supply to the inverter is input to the control power supply (R0, T0) via main power supply (R, S, T), instantaneous power failure tripping or instantaneous power failure retry may be triggered first depending on the operating situation.
- If the control power supply is completely shut off, restarting the inverter is the same as when the power supply is turned on.
- Even if [bb-27] = 00 or 02, an under voltage error will occur if 40 seconds elapse with the main power (R, S, T) dropping.
- Inverter's internal P-N voltage can be monitored with [dA-40].

- When [bb-27] = 00, an under voltage error will not occur if the inverter output is stopping even if the main power is turned off to save energy.
- When [bb-27] = 02, you can avoid under voltage error caused by power shutdown during deceleration and stop.

Parameters.

Name	Code	Data range (unit)	Description
Number of retries after under voltage	[bb-21]	00 to 16(Counts)/ 255(∞)	Set the number of times that an under voltage retry can be performed. If set to 0, the inverter trips without retry. If set to 255, there is no retry limit.
Restart mode selection after instantaneous power failure/under-voltage error	[bb-24]	00	Restarts at 0 Hz
		01	Restart with frequency matching
		02	Restart with active frequency matching
		03	Detect speed (Supported Ver 2.00 or higher)
		04	Decelerate and stop with frequency matching and then trip
Retry wait time after instantaneous power failure/under-voltage error	[bb-26]	0.3 to 100.0(s)	Starts after waiting for the set time upon power voltage recovery.
Enable instantaneous power failure/ under-voltage trip while in stop status	[bb-27]	00	Disabled
		01	Enabled
		02	Disabled during stop and deceleration stop

(Ex. 1) When [bb-21] = 00, tripping occurs.

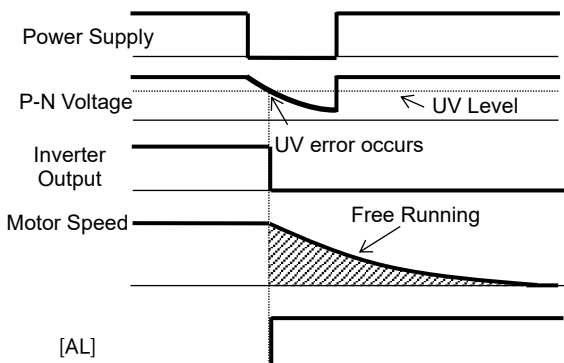

(Ex. 2) When [bb-21] ≠ 00 and [bb-24] = 00, it restarts at 0 Hz.

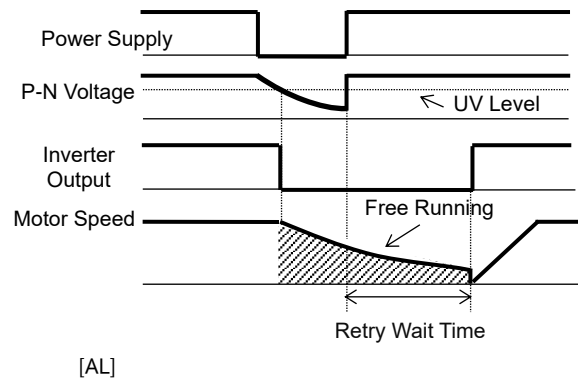

(Ex. 3) When [bb-21] ≠ 00 and [bb-24] = 01, It restart with frequency matching.

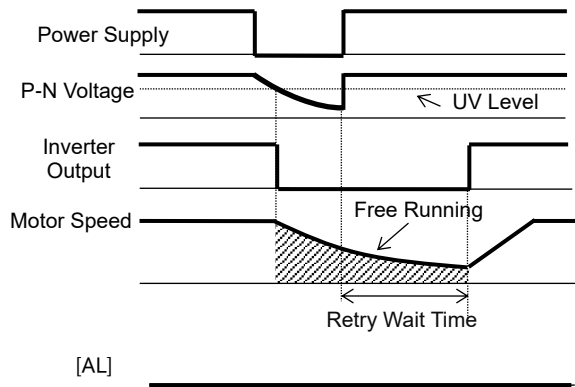

- See "12.14.3 Starting with Frequency Matching" for details.

(Ex. 4) When [bb-21] ≠ 00 and [bb-24] = 02, it restarts with active frequency matching.

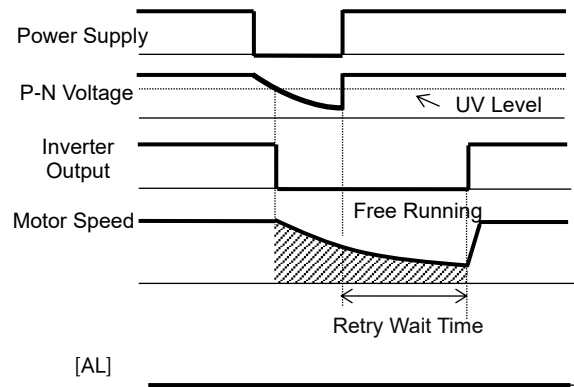

- See "12.14.4 Starting with Active Frequency Matching" for details.

(Ex. 5) When [bb-21] ≠ 00 and [bb-24] = 03, it restarts using the motor speed feedback.

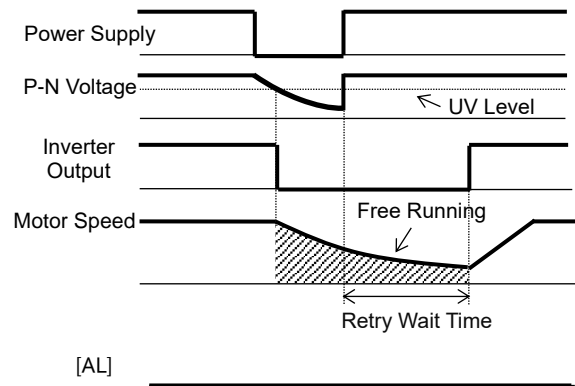

- For motor speed feedback, the feedback input to the input terminals A and B, or feedback input to the optional cassette P1-FB is required.
 - Even when [bb-24] = 03, if the feedback detection speed is less than [bb-42], 0Hz restart is performed.
- See "12.14.3 Starting with Frequency Matching" for details.

(Ex. 6) When [bb-21] ≠ 00 and [bb-24] = 04, it restarts with frequency matching, and then after deceleration according to the setting, the motor trips when stopped.

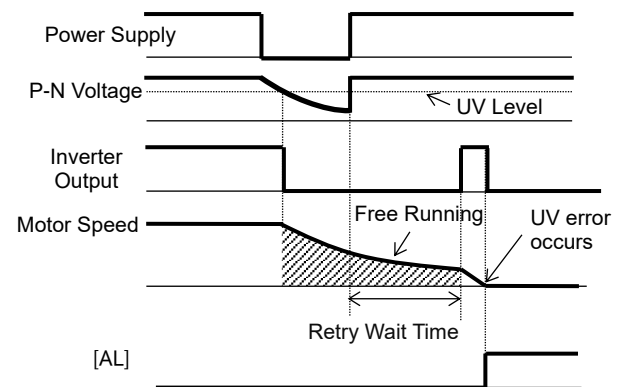

12.13.7 Restarting After Instantaneous Power Failure Recovery

Q

- I want to continue operating the inverter even if an instantaneous power failure occurs.
- I want to set the restart while the control power supply is active by inputting the P-N voltage to the control circuit.
- I want to restart even if the power supply failed by connecting 24 VDC backup power supply.

A

- When the power supply voltage drops below the under voltage level, it is possible to select whether trip ([bb-20] = 00) or restart ([bb-20] ≠ 00) when power supply is recovered.
- If the input power supply to the inverter is input separately to main power supply (R, S, T) and control power supply (R0, T0), the instantaneous power failure is detected based on the main power supply (R, S, T).



- The judgement of instantaneous power failure of the inverter is based on the detection of voltage drop in the main power supply (R, S, T).
- Depending on the fluctuation rate of the main power supply (R, S, T), errors other than instantaneous power failure may occur.
- If the input power supply to the inverter is input to the control power supply (R0, T0) via main power supply (R, S, T), under voltage tripping or under voltage retry may be triggered first depending on the operating situation.
- When the power supplied to the control power supply (R0, T0) is shut off, the power will be lost within about 80 ms. In this case, it will be a power supply shutdown.

- When [bb-27] = 00, It is possible to avoid the [E016] instantaneous power failure error at when turned off power supply while the inverter output is stopped for save energy.
- When [bb-27] = 02, you can avoid instantaneous power failure error caused by power shutdown during deceleration and stop. See also "12.16.6 Detecting Instantaneous Power Failure and Under-Voltage" for more details.

Parameters.

Name	Code	Data range (unit)	Description
Number of retries after instantaneous power failure	[bb-20]	00 to 16(Counts)/255(∞)	Set the number of times that an instantaneous power failure retry can be performed. If set to 0, the inverter trips without retry. If set to 255, there is no retry limit.
Restart mode selection after instantaneous power failure/under-voltage error	[bb-24]	00	Restarts at 0 Hz
		01	Restart with frequency matching
		02	Restart with active frequency matching
		03	Detect speed (Supported Ver 2.00 or higher)
		04	Decelerate and stop with frequency matching and then trip
Instantaneous power failure allowed time	[bb-25]	0.3 to 25.0(s)	Restarts if the instantaneous power failure time is within the set value.
Retry wait time after instantaneous power failure/under-voltage error	[bb-26]	0.3 to 100.0(s)	Starts after waiting for the set time upon power voltage recovery.
Enable instantaneous power failure/ under-voltage trip while in stop status	[bb-27]	00	Disabled
		01	Enabled
		02	Disabled during stop and deceleration stop

(Ex. 1) When [bb-20] = 00, tripping occurs.

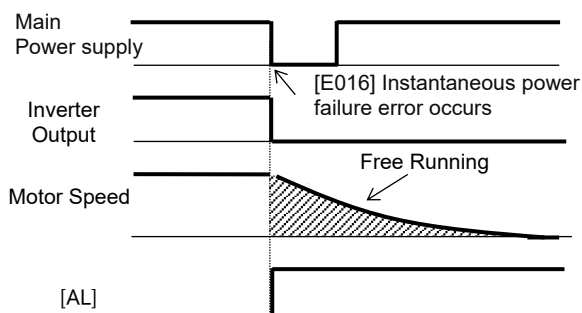

(Ex.2) When [bb-20] ≠00 and [bb-24]=00, restarts at 0 Hz.

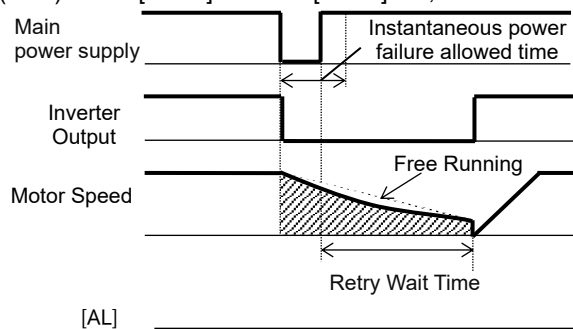

*) A trip occurs, if the power supply recovers after instantaneous power failure allowed time.

(Ex. 3) When [bb-20] ≠ 00 and [bb-24] = 01, it restarts with frequency matching.

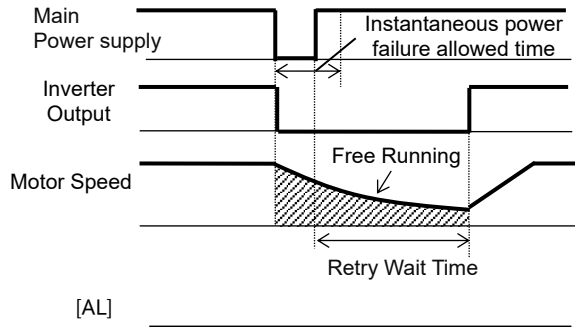

- *) A trip occurs, if the power supply recovers after instantaneous power failure allowed time.
- See "12.14.3 Starting with Frequency Matching " for details.

(Ex. 4) When [bb-20] ≠ 00 and [bb-24] = 02, it restarts with active frequency matching.

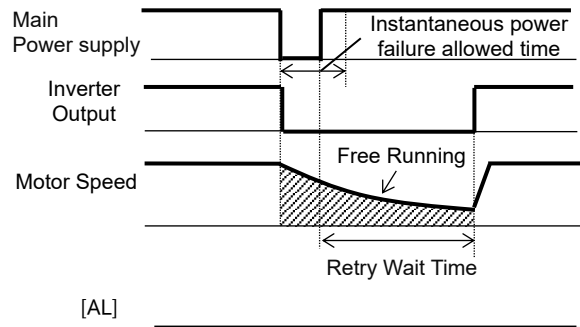

- *) A trip occurs, if the power supply recovers after instantaneous power failure allowed time.
- See "12.14.4 Starting with Active Frequency Matching" for details.

(Ex. 5) When [bb-20] ≠ 00 and [bb-24] = 03, it restarts using the motor speed feedback.

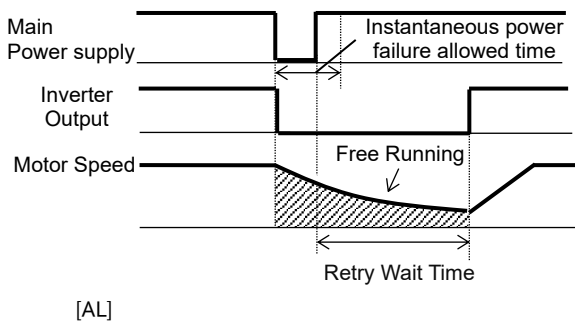

- *) A trip occurs, if the power supply recovers after instantaneous power failure allowed time.
- For motor speed feedback, the feedback input to the input terminals A and B, or feedback input to the optional cassette P1-FB is required.
- Even when [bb-24] = 03, if the feedback detection speed is less than [bb-42], 0Hz restart is performed.
- See "12.14.3 Starting with Frequency Matching" for details.

(Ex. 6) When [bb-20] ≠ 00 and [bb-24] = 04, it restarts with frequency matching, and then deceleration stops and the [E016] Instantaneous power failure occurs.

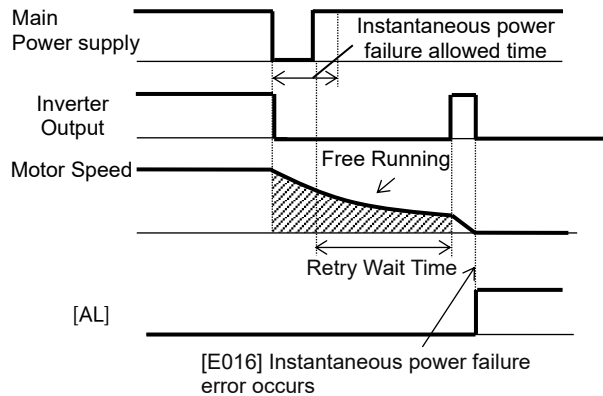

- *) A trip occurs, if the power supply recovers after instantaneous power failure allowed time.

12.13.8 Restarting After Over-Current



- I want to restart the inverter when overcurrent occurs since it does not cause a problem for the system.
- I want the system to continue operating even if overcurrent occurs.



- If overcurrent continues to be observed, there are some possible causes: short acceleration time, heavy load, locked motor, etc.



- In case of overcurrent, you can restart without causing tripping.

Parameters.

Name	Code	Data range (unit)	Description
Overcurrent detection level, 1st-motor	[bb160]	Inverter ND rated current × (0.2 to 2.2) (A)	Sets the level at which the overcurrent is to be detected.
Number of retries after overcurrent	[bb-22]	0 to 5 (Counts)	Set the number of times that an overcurrent retry can be performed. If set to 0, the inverter trips without retry.
Restart mode selection after an overcurrent error	[bb-28]	00	Restarts at 0 Hz
		01	Restart with frequency matching
		02	Restart with active frequency matching
		03	Detection speed (frequency) (Ver 2.00 or higher)
		04	Decelerate and stop with frequency matching and then trip
Retry wait time after an overcurrent error	[bb-29]	0.3 to 100.0(s)	Restarts after waiting for the set time upon overcurrent.

(Ex. 1) When [bb-22] = 00, tripping occurs.

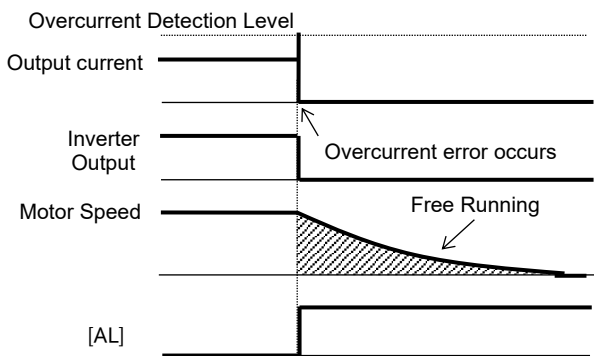

(Ex. 2) When [bb-22] ≠ 00 and [bb-28] = 00, it restarts at 0 Hz.

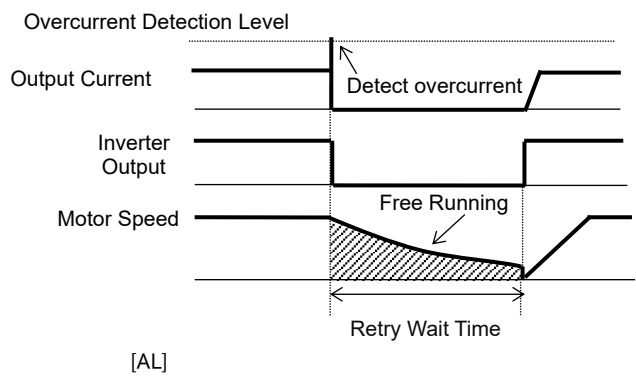

(Ex. 3) When [bb-22] ≠ 00 and [bb-28] = 01, it restarts with frequency matching.

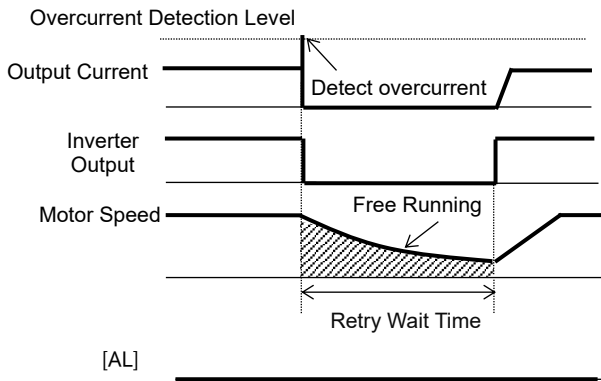

- See "12.14.3 Starting with Frequency Matching" for details.

(Ex. 4) When [bb-22] ≠ 00 and [bb-28] = 02, it restarts with active frequency matching.

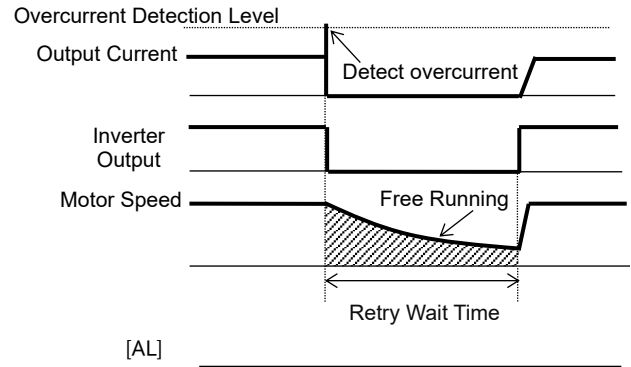

- See "12.14.4 Starting with Active Frequency Matching" for details.

(Ex. 5) When [bb-22] ≠ 00 and [bb-28] = 03, it restarts using the motor speed feedback.

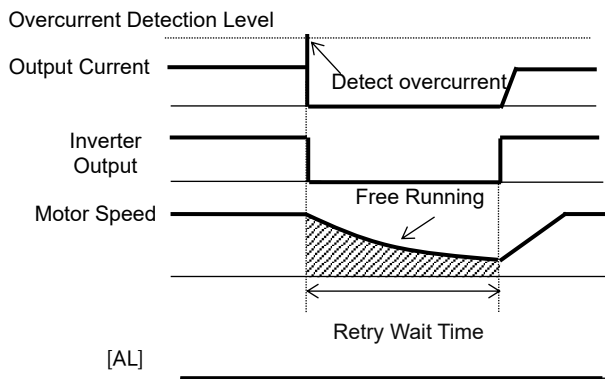

- For motor speed feedback, the feedback input to the input terminals A and B, or feedback input to the optional cassette P1-FB is required.
- Even when [bb-28] = 03, if the feedback detection speed is less than [bb-42], 0Hz restart is performed. see "12.14.3 Starting with Frequency Matching" for details.

(Ex. 6) When [bb-22] ≠ 00 and [bb-28] = 04, it restarts with frequency matching, and then deceleration stops and overcurrent error occurs.

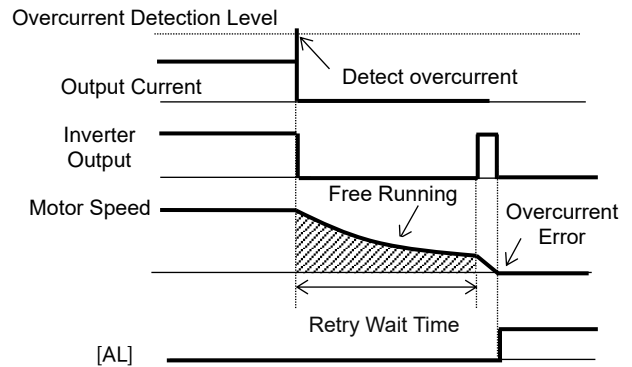

12.13.9 Restarting After Over-Voltage



- I want to restart the inverter when overvoltage occurs since it does not cause a problem for the system.
- I want the system to continue operating even if overvoltage occurs.



- If an overvoltage occurs continuously, the cause may be that the deceleration time is too short, the load is heavy, or the motor is being rotated by an external force, or etc.



- In case of overvoltage, you can restart without causing tripping.

Parameters.

Name	Code	Data range (unit)	Description
Number of retries after over voltage	[bb-23]	0 to 5 (Counts)	Set the number of times that an overvoltage retry can be performed. If it is set to 0, the inverter trips without retry.
Restart mode selection after an overvoltage error	[bb-30]	00	Restarts at 0 Hz
		01	Restart with frequency matching
		02	Restart with active frequency matching
		03	Detection speed (frequency) <Ver 2.00 or higher>
		04	Decelerate with frequency matching and stop then trip
Retry wait time after an overvoltage error	[bb-31]	0.3 to 100.0(s)	After the overvoltage occurs, the inverter restarts after waiting the set time

(Ex. 1) When [bb-23] = 00, tripping occurs.

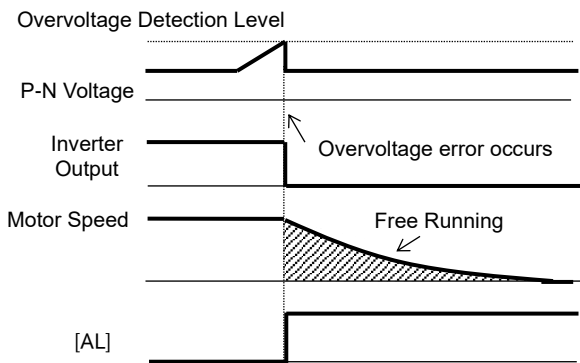

(Ex. 2) When [bb-23] ≠ 00 and [bb-30] = 00, it restarts at 0 Hz.

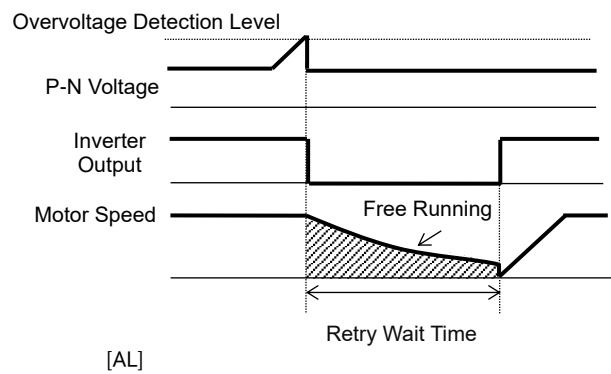

(Ex. 3) When [bb-23] ≠ 00 and [bb-30] = 01, it restarts with frequency matching.

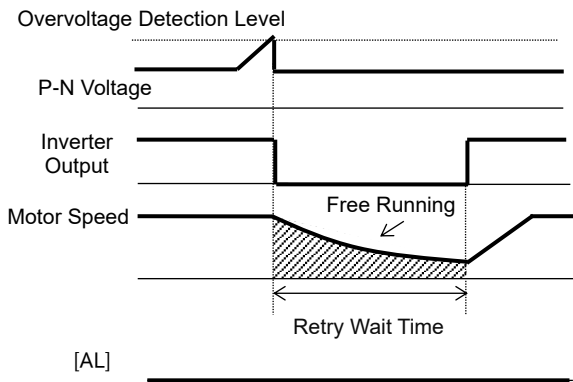

- See "12.14.3 Starting with Frequency Matching" for details.

(Ex. 4) When [bb-23] ≠ 00 and [bb-30] = 02, it restarts active frequency matching.

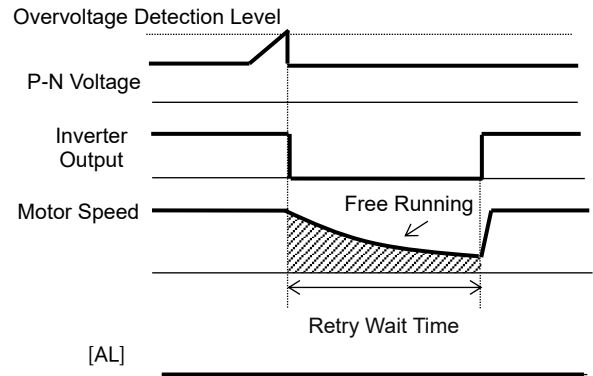

- See "12.14.4 Starting with Active Frequency Matching" for details.

(Ex. 5) When [bb-23] ≠ 00 and [bb-30] = 03, it restarts using the motor speed feedback.

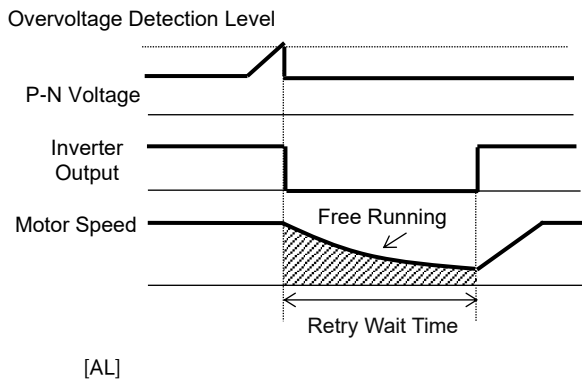

- For motor speed feedback, the feedback input to the input terminals A and B, or feedback input to the optional cassette P1-FB is required.
- Even when [bb-30] = 03, if the feedback detection speed is less than [bb-42], 0Hz restart is performed. See "12.14.3 Starting with Frequency Matching" for details.

(Ex. 6) When [bb-23] ≠ 00 and [bb-30] = 04, it restarts with frequency matching, and then after deceleration, the motor trips then stopped.

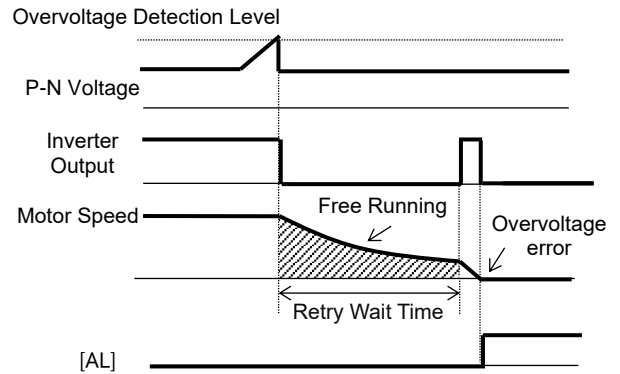

12.13.10 Drive Continues Even after Instantaneous Power Failure

Q

- I want to decelerate and stop the motor even if the instantaneous power failure is not recovered.

A

- This function allows deceleration and stop of the motor while maintaining the voltage under the overvoltage level when the power supply is shut down during operation.
- One of the three modes can be selected with the instantaneous power failure non-stop function, mode selection [bA-30].

!

- Instantaneous power failure non-stop function is activated when the input to the main power supply (R, S, T) drops.
- When [bA-30] is 01 or 02, the motor decelerates and stops after the function is activated. To restart, it is necessary to turn off and on again the RUN command. In addition, even if [bA-30] is 03, if the drive stop without restart after the function is activated, To restart, it is necessary to turn off and on again the RUN command.
- If the control power supply (R0, T0) is not input separately from main power supply, the instantaneous power failure non-stop function works by the P-N voltage to the control power supply (R0, T0). When using this function, disconnect the J51 connector line connected to the R0 and T0 terminals and connect the wire from main terminal P to R0, and N to T0. Use electrical wire of 0.75 mm² or larger.

Parameters.

Name	Code	Data range (unit)	Description
Instantaneous power failure non-stop function, mode selection	[bA-30]	00	Disabled
		01	Decelerates and stops, and maintains the stop status.
		02	Decelerates and stops with constant DC bus voltage control, and maintains the stop status.
		03	Decelerates and stops with constant DC bus voltage control, and maintains the stop status. If the power supply recovers during the process, return to normal running.
Instantaneous power failure non-stop function, start voltage level	[bA-31]	(200 V class) 0.0 to 410.0(VDC) (400 V class) 0.0 to 820.0(VDC)	Is the voltage level at which the instantaneous power failure non-stop control starts when the P-N voltage drops.
Instantaneous power failure non-stop function, target voltage level	[bA-32]	(200 V class) 0.0 to 410.0(VDC) (400 V class) 0.0 to 820.0(VDC)	Is the target output PN voltage when the instantaneous power failure non-stop control is applied.
Instantaneous power failure non-stop function, deceleration time	[bA-34]	0.01 to 3600.00(s)	Sets deceleration time for instantaneous power failure non-stop deceleration and stop operation.
Instantaneous power failure non-stop function, start frequency decrement	[bA-36]	0.00 to 10.00(Hz)	The setting for starting deceleration by lowering frequency during instantaneous power failure non-stop deceleration and stop operation.
Instantaneous power failure non-stop function, DC bus voltage control P gain	[bA-37]	0.00 to 5.00	Proportional gain for PI control during constant DC bus voltage control.
Instantaneous power failure non-stop function, DC bus voltage control I gain	[bA-38]	0.00 to 150.00(s)	Integral gain for PI control during constant DC bus voltage control.
Output terminal function	[CC-01] to [CC-07]	023	[IPS] IP-Non stop function is active OFF: The function is not active. ON: Instantaneous power failure non-stop deceleration in function.

- Instantaneous power failure non-stop
Deceleration stop ([bA-30] = 01).

A

- This function allows deceleration and stop of the motor while maintaining the voltage under the [bA-32] (Instantaneous power failure non-stop function, target voltage level) after the power supply was shut down during operation.
- If the power supply shut off during operation and the P-N voltage falls below the [bA-31] (Instantaneous power failure non-stop function, start voltage level), the output frequency is dropped by the [bA-36] (Instantaneous power failure non-stop function, start frequency decrement), and then decelerates at the [bA-34] (Instantaneous power failure non-stop function, deceleration time).
- During deceleration, if the P-N voltage exceeds the [bA-32] due to regeneration state due to deceleration torque, the speed is constant until the P-N voltage falls below the [bA-32].

!

- If [bA-32] < [bA-31], this function works by equating [bA-32] with [bA-31]. (However, the set values will not be changed).
- If [bA-32] is lower than the input voltage multiplied by $\sqrt{2}$, the constant speed state will be maintained and deceleration will not take place if the power recovers while this function is in operation. (Power should be shut off and turned on again, or [bA-32] needs to be re-setting during operation.). [bA-32] must be set to a value greater than the input voltage multiplied by $\sqrt{2}$.
- This function will not be disabled until the operation stop will be completed. To recover power and restart the operation while this function is in operation, input the stop command (operation command OFF) and then input the operation command again after the motor stopped.
- If [bA-34] is too short, sudden deceleration will cause overcurrent tripping. If [bA-36] is too low or [bA-34] is too long, insufficient regenerative force will cause undervoltage tripping.

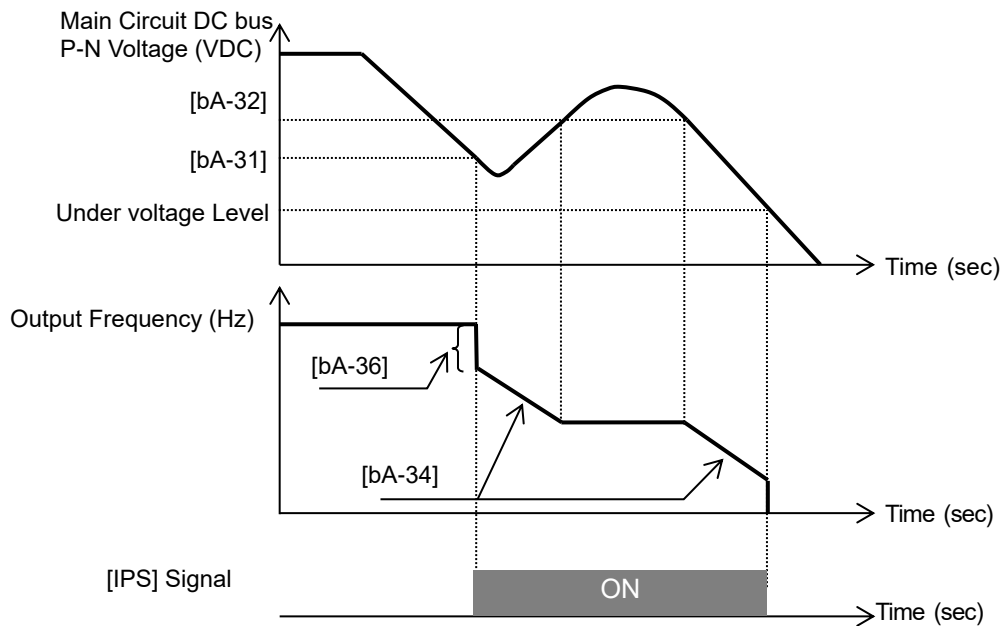

- Instantaneous power failure non-stop.
Constant DC bus voltage control.
([bA-30]=02: No recovery, [bA-30]=03: Recovery)

A

- This function decelerates while maintaining the PN voltage at the value set for the [bA-32] when an instantaneous power failure occurs or the PN voltage drops during operation.
- The condition to activate this function is when all the conditions below are met:
 - [bA-30] is 02 or 03;
 - In operation (It will not function while being tripped, under voltage or stopped);
 - When the instantaneous power failure occurs at the control power supply or when the main circuit P-N voltage drops to the [bA-31] , or lower;
- If the instantaneous power failure time is short, continuous operation without interrupting output is possible. However, if undervoltage is observed upon instantaneous power failure, the output is interrupted immediately and this function will be terminated. The operation after recovering from the instantaneous power failure depends on the selection of how to restart after instantaneous power failure and undervoltage.
- When [bA-30] is 03, the inverter is returned to normal operation if a instantaneous power failure or undervoltage is resolved before the inverter output is shut off. However, it may decelerate and stop depending on the [bA-32] setting. Details are given below.

[bA-30]	[bA-32]	Action
02 (No recovery)	[bA-32] > Received power supply voltage when power recovered	Deceleration stop (constant DC bus voltage control) (Ex.1)
	[bA-32] < Received power supply voltage when power recovered	Deceleration stops (normal operation) (Ex.2)
03 (With recovery)	[bA-32] > Received power supply voltage when power recovered	Deceleration stop (constant DC bus voltage control) (Ex.1)
	[bA-32] < Received power supply voltage when power recovered	Operation (normal operation) (Ex.2)

- Even if the power line for J51 connector connected to R0 and T0 terminals are disconnected to be connected from P of the main terminal to R0 and from N to T0, or even if the control power supply and main circuit power supply are powered independently, this function operates if the above operation start conditions are met.
- If the operation of this function causes a deceleration stop, it will be forcibly stopped even if [FW] is ON. When restarting, confirm that the power has been restored and then turn [FW] ON again.

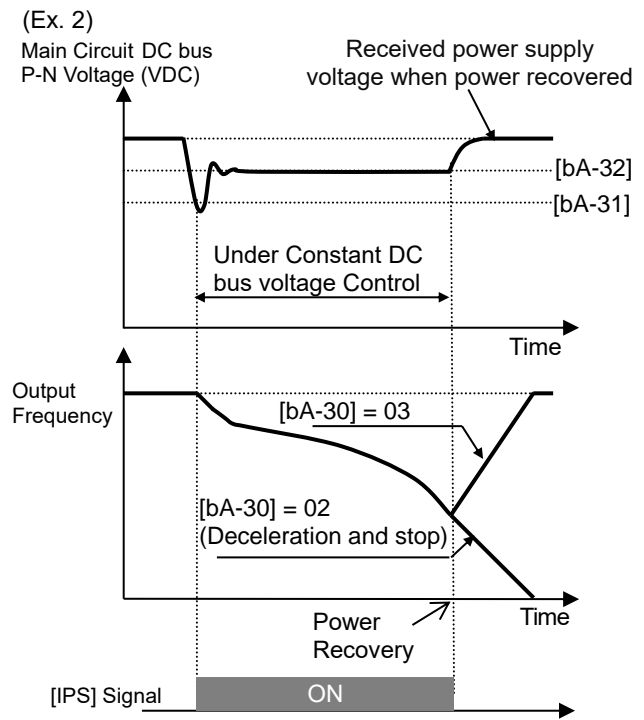
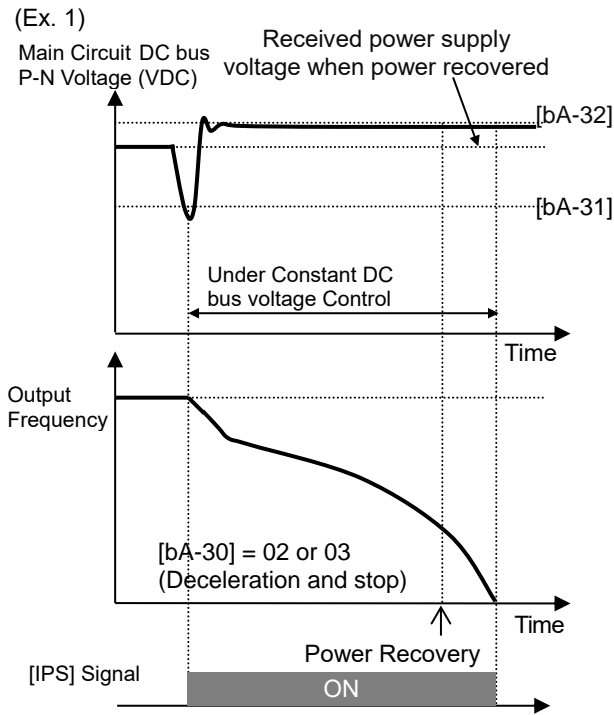

Note) Depending on the proportional gain and integral time settings ([bA-37], [bA-38]), the main circuit DC bus voltage level while the function is being activated may be lower than



- Set [bA-31] and [bA-32] to the under voltage recovery level (P-N voltage 180 VDC (200 V class), 360 VDC (400 V class)) or higher. Otherwise, this function is not work after undervoltage occur.
- Set [bA-31] lower than [bA-32]. If the difference between the settings of [bA-31] and [bA-32] is large and the proportional gain [bA-37] is set too high, the motor may suddenly accelerate immediately after this function operates and overcurrent may occur.
- When [bA-30] is 02 or 03, PI control is performed so that the P-N voltage becomes as constant.
- Setting the proportional gain [bA-37] is set to a large value, the response becomes faster. However, setting it to be too large may dissipate the control, tending to cause tripping.
- Setting the integral gain [bA-38] is set to a small value, the response becomes faster. However, setting it to be too small may also tend to cause tripping.
- If the proportional gain [bA-37] is small, an undervoltage trip may occur due to the voltage drop immediately after the start of function operation.
- In order to retry even with a relatively long instantaneous power failure, supply power R0 and T0 from the P- N voltage.

12.14 Each Start Mode Settings

12.14.1 Starting with Gradually Increasing Voltage



- How to minimize overcurrent at starting when the minimum frequency has been set high to obtain a higher torque.



- This function allows you to make the inverter increase the voltage gradually when starting the motor while outputting the minimum frequency.
- The time to reach the output voltage for the reduced voltage start can be set with [Hb131].



- Set a small value for the Reduced voltage start time setting [Hb131] if you intend to increase the start torque. On the other hand, if it is set to a small value, it will be in a state similar to inputting commercial power directly to the inverter, and overcurrent trips are likely to occur.
- This function is effective only when V/f control (constant torque characteristics, reduced torque characteristics, or free V/f control) is selected for the Control mode selection [AA121].

Name	Code	Data range (unit)	Description
Minimum frequency adjustment, 1st-motor	[Hb130]	0.10 to 10.00(Hz)	Sets the start frequency.
Reduced voltage start time setting, 1st-motor	[Hb131]	0 to 2000(ms)	Sets the time to increase the voltage from the start of RUN command to the output voltage corresponding to the minimum frequency.

(Ex. 1) In case of reduced voltage start time setting = 0ms

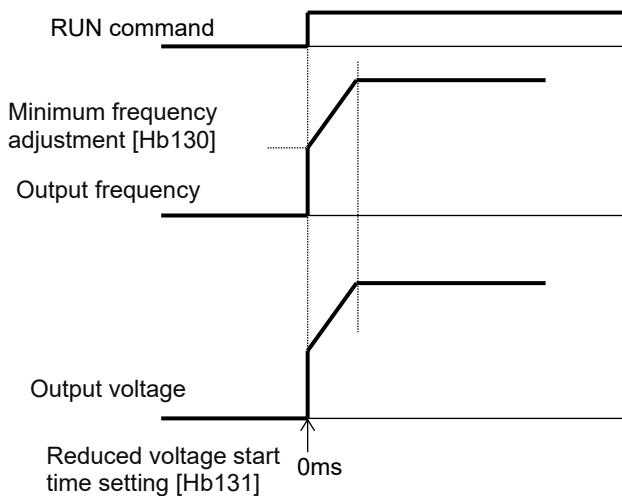

(Ex. 2) In case of reduced voltage start time setting = 10ms

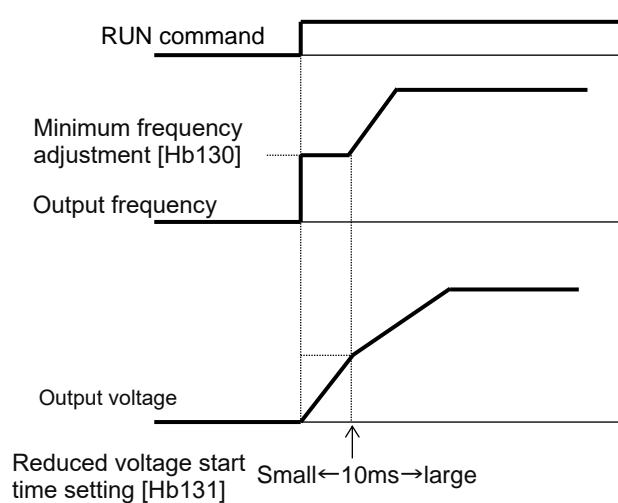

12.14.2 Starting with DC Braking

Q

- I want to stop the free-running fan first and then start it again.
- I want to operate the inverter after stopping the motor with the DC braking.

A

- Before outputting the frequency to the motor, apply DC braking to stop the motor rotating. And then, start operation.
- To use DC braking for starting, the following settings are required:
 - Set [AF101] DC braking selection to 01;
 - Set [AF102] Braking type selection to 00
 - Set [AF109] DC braking active time at start to other than 0.0;
- In DC braking for starting, DC braking is performed, after the operation command is given, for the period of time set for the DC braking active time at start [AF109].

!

- The carrier frequency during DC braking is depending on the Carrier frequency setting [bb101], however it may automatically drop to 2 kHz depending on the braking force setting.
- When setting or operating the DC braking force at start [AF108] and the DC braking active time at start [AF109], pay attention to heat generation on the motor.

■ Example of a case where the DC braking function for starting is applied.

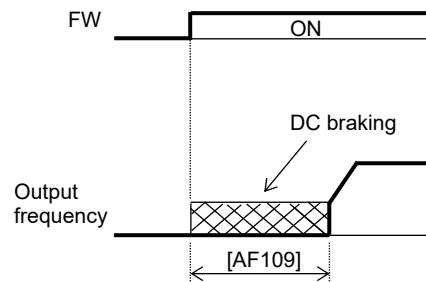

■ Parameters.

Name	Code	Data range (unit)	Description
DC braking selection, 1st-motor	[AF101]	00	Internal DC braking: Disabled
		01	Internal DC braking: Enabled
		02	Internal DC braking: Enabled (operable only at the set frequency)
Braking type selection, 1st-motor	[AF102]	00	Enables the DC braking.
DC braking force at start, 1st-motor	[AF108]	0 to 100(%) (Might be internally limited)	Adjusts the DC braking force. The maximum braking force is achieved when set to 100%.
DC braking active time at start, 1st-motor	[AF109]	0.0 to 60.0(s)	Valid when the internal DC braking is enabled. Starts the DC braking when the RUN command is turned on.

!

- If [AF101] DC braking selection is set to 02, DC braking will be started when both the frequency command and the output frequency become equal to or lower than [AF103] DC braking frequency setting, regardless of whether the motor is running or stopped. See "12.15.2 Stopping with DC Braking" for details.
- If the Braking type selection [AF102] is set to other than 00, see "12.14.9 Starting with Servo Lock".

12.14.3 Starting with Frequency Matching

Q

- How to start the inverter with the frequency matched with the speed when the motor is in free-running.
- How to start operation matched with frequency at the time of trip retry, free-run stop, reset, power-on, etc.

A

- If the motor runs idle due to trips or terminal functions, the frequency matching function can be set for each factor.
- The frequency matching function detects the residual voltage of the motor and starts the operation.
- Frequency matching minimum restart frequency [bb-42] is the parameter common to frequency matching functions.

!

- Even if frequency matching restart is selected, the inverter may restart with 0 Hz if:
 - The output frequency is equal to or lower than 1/2 of the base frequency;
 - The voltage induced on the induction motor quickly attenuates;
 - The frequency matching minimum restart frequency [bb-42] is set and the inverter detects a frequency equal to or lower than that.
- If the restart after free-run stop or the restart after reset is performed, the inverter will restart after the retry wait time after instantaneous power failure/under-voltage has elapsed.
- The restart after free-run stop and the restart after reset will be performed if the RUN command is continuously input via a terminal command or other ways.
- If the frequency matching restart does not go well because the residual voltage rapidly decreases or for other reasons, it may go well by using the active frequency matching restart. See "12.14.4 Starting with Active Frequency Matching".

(Ex. 1) When the motor speed is equal to or higher than the frequency matching minimum restart frequency setting [bb-42].

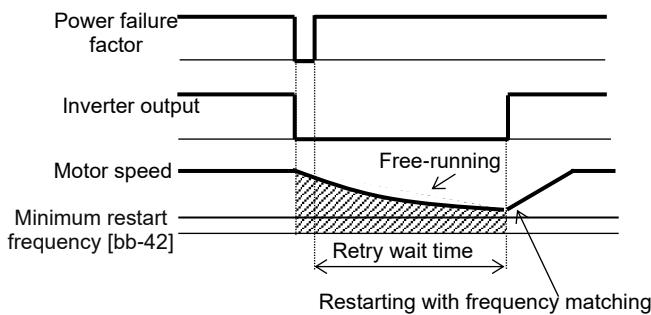

(Ex. 2) When the motor speed is equal to or lower than the frequency matching minimum restart frequency setting [bb-42].

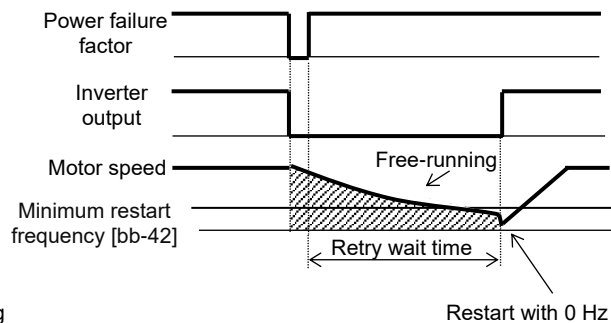

Parameter.

Name	Code	Data range (unit)	Description
Frequency matching minimum restart frequency	[bb-42]	0.00 to 590.00(Hz)	When the detected value is equal to or lower than the set value, the inverter restarts with 0 Hz.

!

- For the retry function, see "12.13 Functions to Prevent Trips or Restart on Trips" as well.
- When 03 (detection speed) is selected for each restart mode parameter, feedback input to input terminals A and B or feedback input to option P1-FB is required.
- When the feedback detection speed is less than [bb-42], 0Hz restart is performed.

■ When instantaneous power failure/under-voltage occurs. [bb-24]=01,03.

t0: Instantaneous power failure time;
 t1: Instantaneous power failure allowed time [bb-25];
 t2: Retry wait time [bb-26];

(Ex. 1) Power recovery within the Instantaneous power failure allowed time [bb-25].

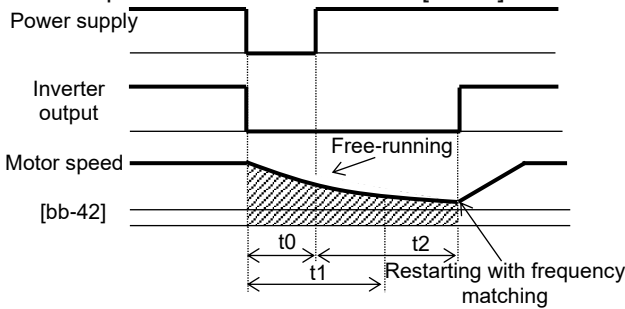

(Ex. 2) Power recovery after the instantaneous power failure allowed time [bb-25].

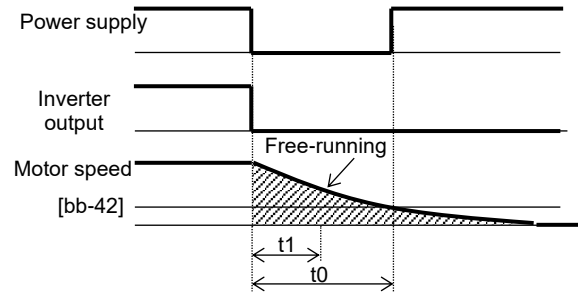

Name	Code	Data range (unit)	Description
Restart mode selection after instantaneous power failure/under-voltage error	[bb-24]	01	Performs frequency matching restart.
Instantaneous power failure allowed time	[bb-25]	0.3 to 25.0(s)	Restarts the motor if the power supply recovers within the allowable time.
Retry wait time after instantaneous power failure/under-voltage	[bb-26]	0.3 to 100.0(s)	Sets the wait time after power supply recovers, [FRS] turns OFF or [FRS] turns OFF.



- If a power failure has occurred so that the power to the inverter's control power supply terminals (R0, T0) is lost, and then the inverter is restarted, it is considered as power-on and the inverter will operate in accordance with the Restart mode after RS release [bb-41].
- Even if the power to control power supply terminals (R0, T0) is lost, it will take time until the main circuit power supply is completely lost.
- Trip after instantaneous power failure/under-voltage can be switched between "enabled" and "disabled" by using the Enable instantaneous power failure/ under-voltage trip while in stop status [bb-27]. This will prevent the occurrence of an error during stopping. If the error is prevented, the output terminal [AL] will not turn on.
- In a system where the power to control power supply terminals (R0, T0) gradually decreases, it is possible to cause a trip when Allowable instantaneous power failure time has elapsed.
- To make the power to control power supply terminals (R0, T0) last as much as possible by the inverter alone during an instantaneous power failure, remove the J51 connector cables from terminals R0 and T0, and connect a cable from P on the main circuit terminal block to R0, and N on the main circuit terminal block to T0. Use 0.75 mm² or thicker wires for the connections.

- Retry of overcurrent. [bb-28]=01,03.
(Ex.) Frequency matching operation after overcurrent.

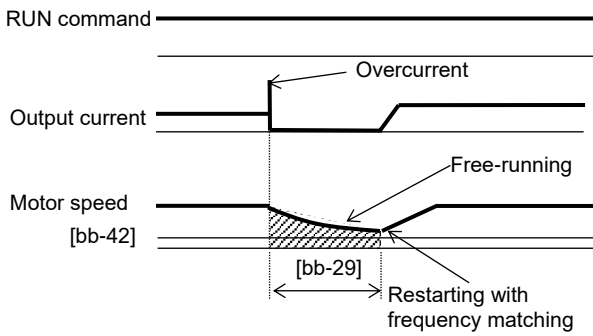

Name	Code	Data range (unit)	Description
Restart mode selection after an overcurrent error	[bb-28]	01	Performs frequency matching restart.
		03	Performs feedback detection speed restart.
Retry wait time after an overcurrent error	[bb-29]	0.3 to 100.0(s)	Sets the wait time after overcurrent

- Retry of overvoltage. [bb-30]=01,03.
(Ex.) Frequency matching operation after overvoltage.

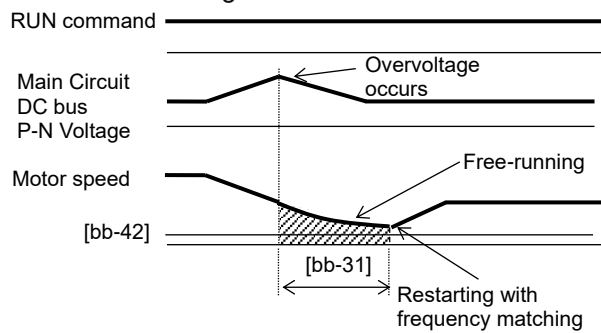

Name	Code	Data range (unit)	Description
Restart mode selection after an overvoltage error	[bb-30]	01	Performs frequency matching restart.
		03	Performs feedback detection speed restart.
Retry wait time after an overvoltage error	[bb-31]	0.3 to 100.0(s)	Sets the wait time after overvoltage

- Frequency matching after free run stop [FRS]. [bb-40]=01,03.
(Ex.) Frequency matching operation after free-run stop [FRS] release.

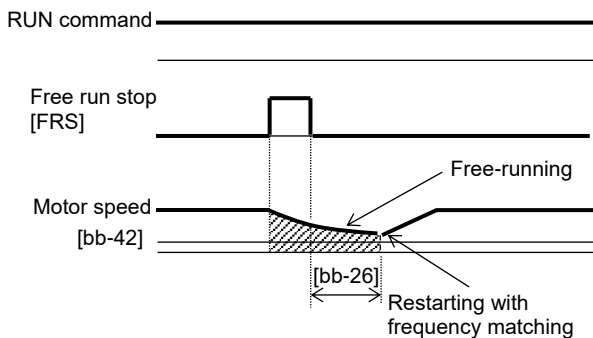

Name	Code	Data range (unit)	Description
Restart mode after FRS release	[bb-40]	01	Performs frequency matching restart.
		03	Performs feedback detection speed restart.
Retry wait time after instantaneous power failure / under-voltage error	[bb-26]	0.3 to 100.0(s)	Sets the wait time after [FRS] release.

- Frequency matching after reset [RS]. [bb-41]=01,03.
(Ex.) Frequency matching operation after reset [RS] release.

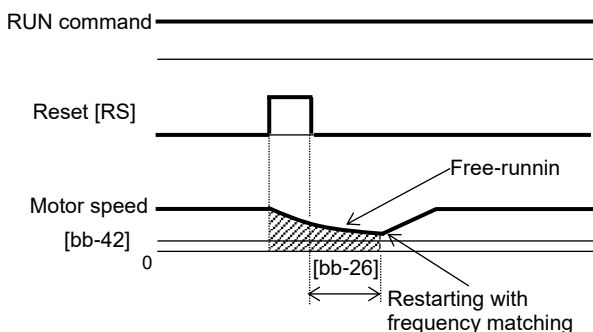

Name	Code	Data range (unit)	Description
Restart mode after RS release	[bb-41]	01	Performs frequency matching restart.
		03	Performs feedback detection speed restart.
Retry wait time after instantaneous power failure/under-voltage error	[bb-26]	0.3 to 100.0(s)	Sets the wait time after [RS] release.

*) When frequency matching after reset is set, the behavior at power-on is also set to frequency matching.

12.14.4 Starting with Active Frequency Matching



- I want to restart the inverter by quickly following the frequency reference regardless of the speed of the idling motor.
- I want to operate the inverter quickly at the frequency reference when trip retry, free run stop, reset, power recycle, etc. occur.



- If the motor runs idle due to trips or terminal functions, the active frequency matching function can be set for each factor.
- Even if a motor residual voltage is lost, the inverter will restart at the frequency selected in the Active frequency matching restart speed selection [bb-47].

(Ex.) The operation of active frequency matching.

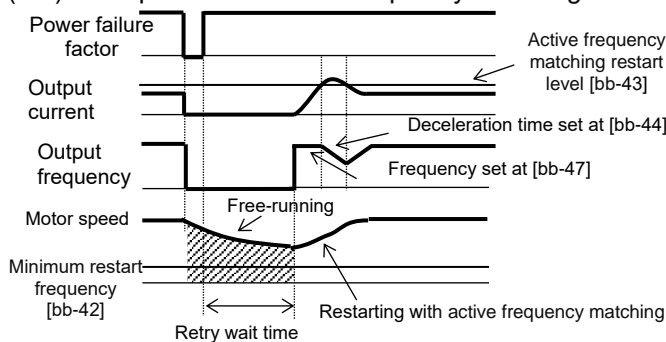

- If the restart after free-run stop or the restart after reset is performed, the inverter will restart after the retry wait time after instantaneous power failure/under-voltage has elapsed.
- The restart after free-run stop and the restart after reset will be performed when the RUN command is given.
- The active frequency matching restart function can be used only for induction motor drive. In addition, if the Control mode selection [AA121] is set to other than the V/f control, restart may become unstable. In this case, see "12.14.3 Starting with Frequency Matching".

- When active frequency matching with the V/f control is selected, the inverter starts with a suppressed output voltage during the time set for active frequency matching restart constant (voltage) [bb-45]. When sensorless vector control, zero-speed range sensorless vector control, or vector control with sensor is selected, the frequency is automatically active frequency matching while controlling the current.
- If the current increases during active frequency matching to exceed the restart level [bb-43], the motor will decelerate at the time set for the active frequency matching restart constant (speed) [bb-44].
- If the current rapidly increases during active frequency matching to exceed OC-suppress level at active frequency matching [bb-46], the overcurrent suppression function operates automatically.

■ Parameters.

Name	Code	Data range (unit)	Description
Frequency matching minimum restart frequency	[bb-42]	0.00 to 590.00 (Hz)	If the frequency at restart (depend on [bb-47] setting) is below the this set value, restart at 0Hz.
Active frequency matching restart level	[bb-43]	Inverterrated current × (0.2 to 2.0) (A)	Determines whether or not the current has increased at restart.
Active frequency matching restart constant (speed)	[bb-44]	0.10 to 30.00 (s)	Sets the deceleration time for an increase in the current.
Active frequency matching restart constant (voltage)	[bb-45]	0.10 to 30.00 (s)	Sets the time to start with reduced output voltage.
OC-suppress level at active frequency matching	[bb-46]	Inverterrated current × (0.0 to 2.0) (A)	Sets the level of the current at which a sudden current increase at restarting is prevented.
Active frequency matching restart speed selection	[bb-47]	00	Start-up at the frequency at the previous shutoff.
		01	Start-up at the maximum frequency.
		02	Start-up at the current frequency command.

- When instantaneous power failure/under-voltage occurs [bb-24]=02.

t0: Instantaneous power failure time
 t1: Instantaneous power failure allowed time [bb-25]
 t2: Retry wait time [bb-26]

(Ex. 1) Power recovery within Instantaneous power failure allowed time [bb-25]

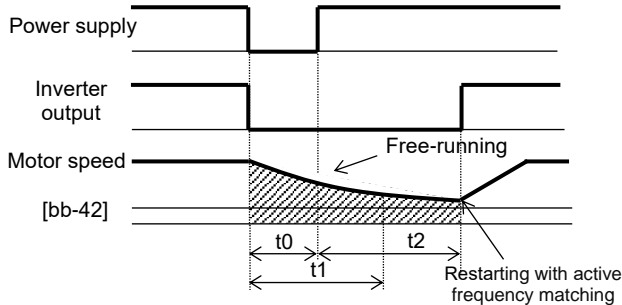

(Ex. 2) Power recovery after Instantaneous power failure allowed time [bb-25]

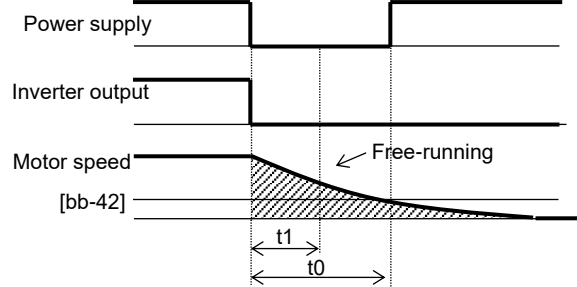

Parameters.

Name	Code	Data range (unit)	Description
Restart mode selection after instantaneous power failure/under-voltage error	[bb-24]	02	Performs active frequency matching restart.
Instantaneous power failure allowed time	[bb-25]	0.3 to 25.0(s)	Restarts the motor if the power supply recovers within the allowable time.
Retry wait time after instantaneous power failure/under-voltage error	[bb-26]	0.3 to 100.0(s)	Sets the wait time after power supply recovers, [FRS] turns OFF or [FRS] turns OFF.



- If a power failure has occurred so that the power to the inverter's control power supply terminals (R0, T0) is lost, and then the inverter is restarted, it is considered as power-on and the inverter will operate in accordance with the Restart mode after RS release [bb-41].
- Even if the power to control power supply terminals (R0, T0) is lost, it will take time until the internal power supply is completely lost.
- Trip after instantaneous power failure/under-voltage can be switched between "enabled" and "disabled" by using the Enable instantaneous power failure/ under-voltage trip while in stop status [bb-27]. This will prevent the occurrence of an error during stopping. If the error is prevented, the output terminal [AL] will not turn on.
- In a system where the power to control power supply terminals (R0, T0) gradually decreases, it is possible to cause a trip when Allowable instantaneous power failure time has elapsed.
- To make the power to control power supply terminals (R0, T0) last as much as possible by the inverter alone when an instantaneous power failure occurs, remove the J51 connector cables from terminals R0 and T0, connect the main circuit terminals P and R0 to each other, and connect the main terminals N and T0 to each other. Use 0.75 mm² or thicker wires for the connections.

■ Retry of overcurrent. [bb-28]=02.
 (Ex.) Active frequency matching operation after overcurrent.

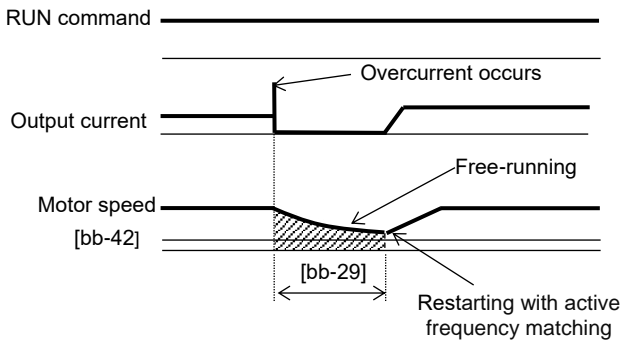

Name	Code	Data range (unit)	Description
Restart mode selection after an overcurrent error	[bb-28]	02	Performs active frequency matching restart.
Retry wait time after an overcurrent error	[bb-29]	0.3 to 100.0(s)	Sets the wait time after overcurrent occurs.

■ Retry of overvoltage. [bb-30]=02.
 (Ex.) Active frequency matching operation after overvoltage.

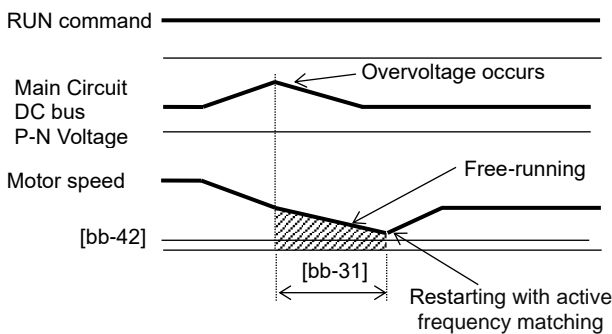

Name	Code	Data range (unit)	Description
Restart mode selection after an overvoltage error	[bb-30]	02	Performs active frequency matching restart.
Retry wait time after an overvoltage error	[bb-31]	0.3 to 100.0(s)	Sets the wait time after overvoltage occurs.

■ Active frequency matching after free run stop [FRS]. [bb-40]=02.
 (Ex.) Active frequency matching operation after free run stop [FRS] release.

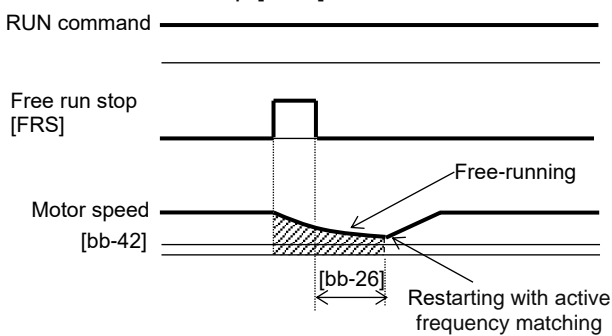

Name	Code	Data range (unit)	Description
Restart mode after FRS release	[bb-40]	02	Performs active frequency matching restart.
Retry wait time after instantaneous power failure/under-voltage error	[bb-26]	0.3 to 100.0(s)	Sets the wait time after [FRS] release.

■ Active Frequency matching after reset [RS]. [bb-41]=02.
 (Ex.) Active frequency matching operation after reset [RS] release.

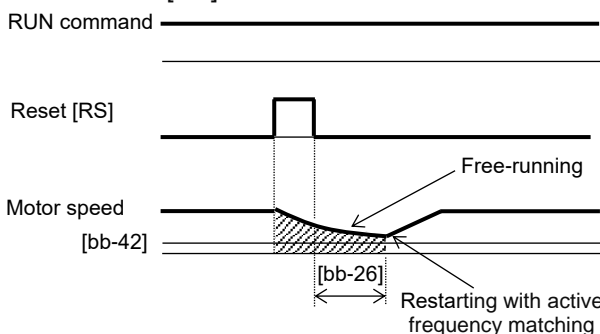

Name	Code	Data range (unit)	Description
Restart mode after RS release	[bb-41]	02	Performs active frequency matching restart.
Retry wait time after instantaneous power failure/under-voltage error	[bb-26]	0.3 to 100.0(s)	Sets the wait time after [RS] release.

*) When active frequency matching after reset is set, the behavior at power-on is also set to active frequency matching.

12.14.5 Starting after Power-On

Q

- How to start operation with frequency matching because the motor is in free running state at power-on.
- How to start operation with 0 Hz because the brake is applied at starting.

!

- The operation at power-on is the same as that of the restart after reset stop which occurs when the inverter recovers from reset.
- If the active frequency matching restart is used, the rotational direction of the output frequency is the same as that of the frequency command.
- If a power failure lasts long and the inverter's P-N voltage is lost, recovery will take place by the restart after reset instead of the restart after instantaneous power failure/under-voltage.
- In the case of [bb-41]=01, if the residual voltage generated by the motor cannot be detected, the 0 Hz restart may take place.

A

- Set the start mode at power-on.

(Ex. 1) Restart operation with 0 Hz. [bb-41]=00

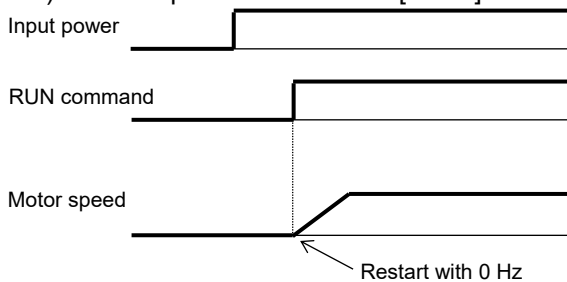

(Ex. 2) Restart operation with frequency matching. [bb-41]=01 to 03

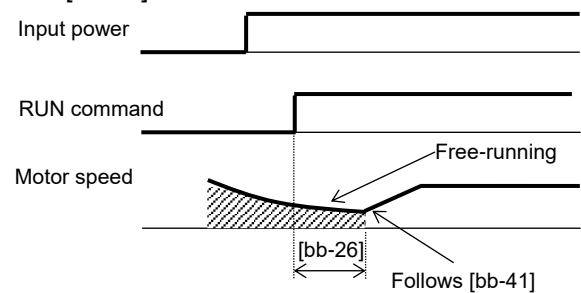

Parameters.

Name	Code	Data range (unit)	Description
Restart mode after RS release	[bb-41]	00	Performs the 0 Hz restart.
		01	Performs frequency matching restart. * 1)
		02	Performs active frequency matching restart. * 2)
		03	Performs feedback detection speed restart. *3)
Retry wait time after instantaneous power failure/under-voltage error	[bb-26]	0.3 to 100.0(s)	Sets the wait time after power supply recovers, [FRS] turns OFF or [FRS] turns OFF.

* 1) See "12.14.3 Starting with Frequency Matching".

*2) See "12.14.4 Starting with Active Frequency Matching".

*3) When 03 (detection speed) is selected, feedback input to input terminals A and B or feedback input to option P1-FB is required.

12.14.6 Starting after Reset

Q

- How to start operation with frequency matching because the motor is in free running state at trip reset.
- How to start operation with 0 Hz because the brake is applied after a trip.

A

- Settings the startup method with the reset input by trip reset and the reset input with 028 [RS] input terminal.

!

- The restart after reset, which occurs when the inverter recovers from a reset, is the same as the mode at power-on.
- If the active frequency matching restart is used, the rotational direction of the output frequency is the same as the command direction at shut-off.
- If a power failure lasts long and the inverter's P-N voltage is lost, recovery will take place by the restart after reset instead of the restart after instantaneous power failure/under-voltage.
- In case of the 0 Hz restart, there is no wait time.

(Ex. 1) Restart operation with 0 Hz. [bb-41]=00

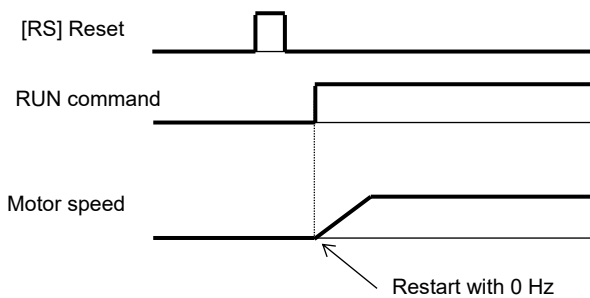

(Ex. 2) Restart operation with frequency matching. [bb-41]=01 to 03.

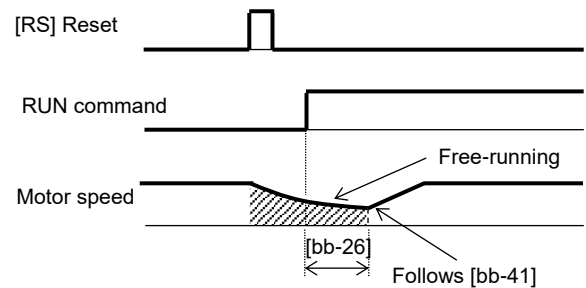

(Ex. 3) Restart with 0 Hz. [bb-41]=00.

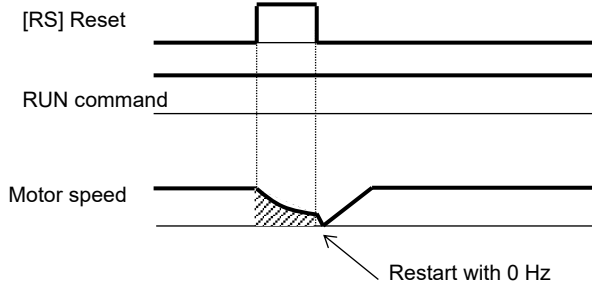

(Ex. 4) Restart operation with frequency matching. [bb-41]=01 to 03.

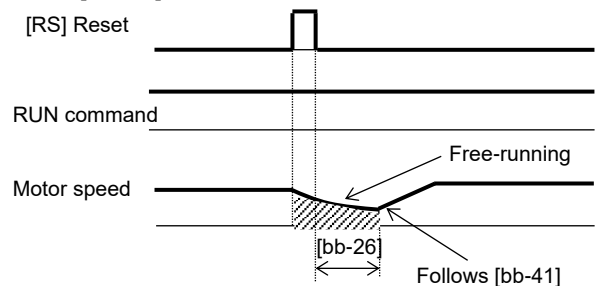

■ Parameters.

Name	Code	Data range (unit)	Description
Restart mode after RS release	[bb-41]	00	Performs the 0 Hz restart.
		01	Performs frequency matching restart.* 1)
		02	Performs active frequency matching restart.* 2)
		03	Performs feedback detection speed restart.* 3)
Retry wait time after instantaneous power failure/under-voltage error	[bb-26]	0.3 to 100.0(s)	Sets the wait time after power supply recovers, [FRS] turns OFF or [FRS] turns OFF.

* 1) See "12.14.3 Starting with Frequency Matching".

*2) See "12.14.4 Starting with Active Frequency Matching".

*3) When 03 (detection speed) is selected, feedback input to input terminals A and B or feedback input to option P1-FB is required.

12.14.7 Starting after Free Run Stop

Q

- How to start operation with frequency matching because the motor is in free running when the free-run stop terminal is turned off.
- How to start operation with 0 Hz because the brake is applied at stopping although free-run stop has been specified for stopping.

A

- Set the start mode after free-run stop function via the input terminal function 032 [FRS], (Ex.1) to (Ex. 4), or start mode after stop when FRS (free run to stop) is specified for [AA115] Stop mode selection, (Ex. 5) and (Ex. 6).
- (Ex. 1) to (Ex. 4) below are examples where a free-run stop command is input using the [FRS] terminal.

!

- The restart after reset, which occurs when the inverter recovers from a reset, is the same as the mode at power-on.
- If the active frequency matching restart is used, the rotational direction of the output frequency is the same as that of the frequency command.
- If a power failure lasts long and the inverter's internal power supply is lost, recovery will take place by the restart after reset instead of the restart after instantaneous power failure/under-voltage.
- At power-on, the inverter will start operation with 0 Hz.
- In case of the 0 Hz restart, there is no wait time.

(Ex. 1) Restart with 0 Hz. [bb-40]=00.

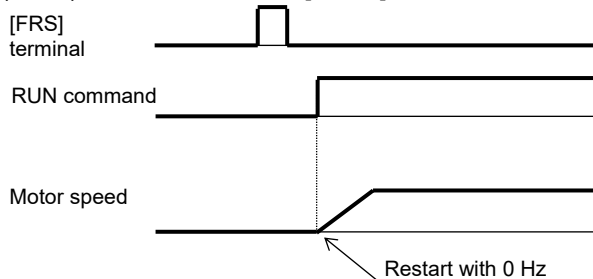

(Ex. 3) Restart with 0 Hz. [bb-40]=00.

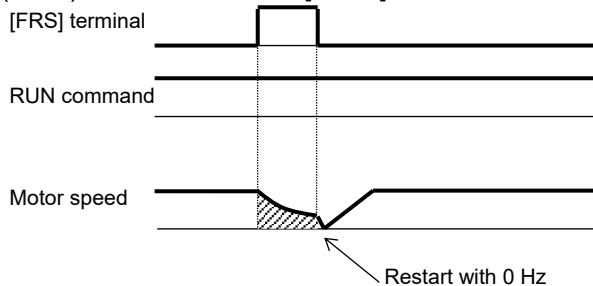

(Ex. 2) Restart operation with frequency matching. [bb-40]=01 to 03.

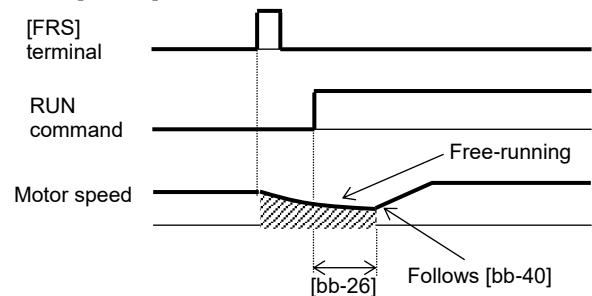

(Ex. 4) Restart operation with frequency matching. [bb-40]=01 to 03.

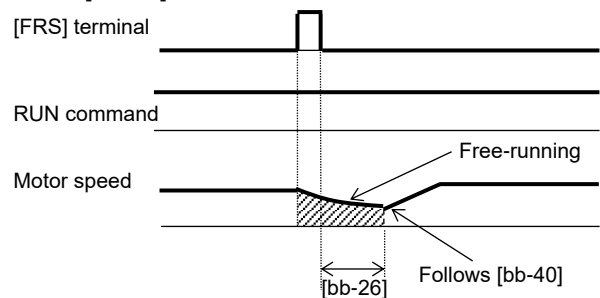

A

- (Ex. 5) and (Ex. 6) below show cases where the free-run stop is performed via the operation command.

- The free-run stop at stopping is used when an overvoltage error occurs at stopping, for example. However, the motor continues rotating through inertia.

(Ex. 5) Restarting with 0 Hz. [bb-40]=00.
And the STOP mode selection [AA115]=01(free run).

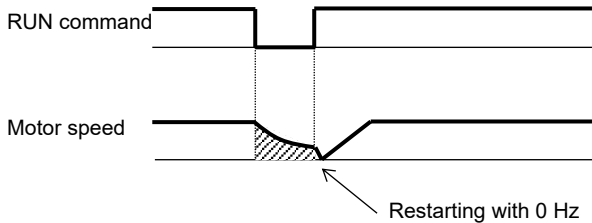

(Ex. 6) Restart operation with frequency matching. [bb-40]=01 to 03.
And the STOP mode selection [AA115]=01(free run).

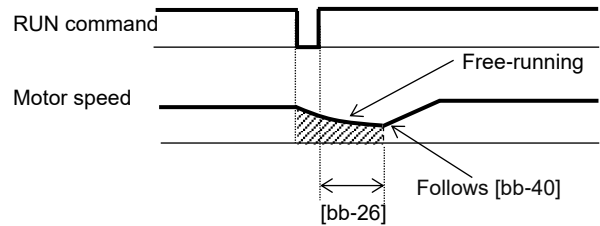

■ Parameters.

Name	Code	Data range (unit)	Description
Restart mode after FRS release	[bb-40]	00	Performs the 0 Hz restart.
		01	Performs frequency matching restart.* 1)
		02	Performs active frequency matching restart.* 2)
		03	Performs feedback detection speed restart.* 3)
Retry wait time after instantaneous power failure/under-voltage error	[bb-26]	0.3 to 100.0(s)	Sets the wait time after power supply recovers, [FRS] turns OFF or [FRS] turns OFF.
STOP mode selection, 1st-motor	[AA115]	01	Performs the free-run stop when the RUN command is off.

* 1) See "12.14.3 Starting with Frequency Matching".

*2) See "12.14.4 Starting with Active Frequency Matching".

*3) When 03 (detection speed) is selected, feedback input to input terminals A and B or feedback input to option P1-FB is required.

12.14.8 Starting with Torque Quick Rising

Q

- How to make torque rise faster at start-up.
- The motor starts rotating slowly after an RUN command is given.

A

- The pre-excitation (forcing) function allows the excitation current to flow to the motor before starting and establishes the magnetic flux in advance to accelerate the rise of torque. Forcing (pre-excitation) function operates by assigning the input terminal function 066 [FOC] and turn it on.

- When the Stop mode selection [AA115] is set to 00.

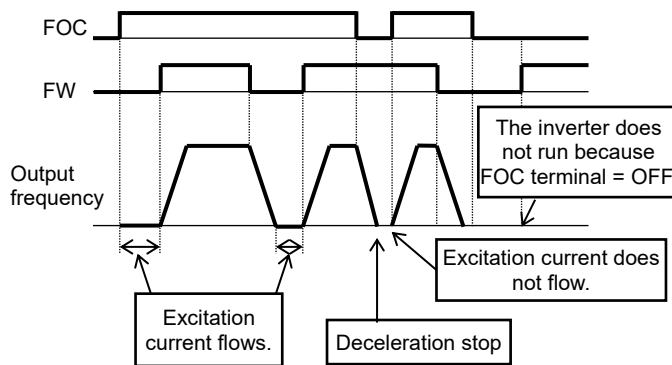

!

- This function is effective when the Sensorless vector control (IM), Zero-Hz-range sensorless vector control (IM), or Vector control with encoder (IM) is selected for the control mode [AA121].
- If [FOC] is assigned to the input terminal function, RUN command will not be accepted unless [FOC] is turned on.
- If [FOC] is turned off during operation, the inverter will be operated according to the Stop mode selection [AA115]. If a free run occurs, restart will take place according to the setting for the restart after free-run stop.

- When the Stop mode selection [AA115] is set to 01.

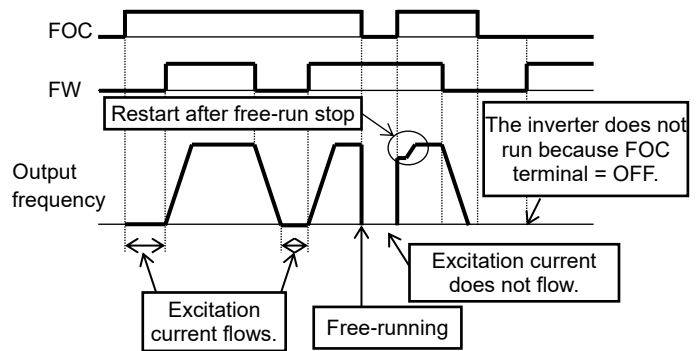

■Parameters.

Name	Code	Data range (unit)	Description
Input terminal function	[CA-01] to [CA-11]	066	Forcing function [FOC]
STOP mode selection, 1st-motor	[AA115]	00	Performs the deceleration stop when the operation command is off.
		01	Performs the free-run when the operation command is off.
Restart mode after FRS release	[bb-40]	00	Performs the 0 Hz restart.
		01	Performs frequency matching restart.* 1)
		02	Performs active frequency matching restart.* 2)
		03	Performs feedback detection speed restart.* 3)
Retry wait time after instantaneous power failure/under-voltage error	[bb-26]	0.3 to 100.0(s)	Sets the wait time after power supply recovers, [FRS] turns OFF or [FRS] turns OFF.

* 1) See "12.14.3 Starting with Frequency Matching".

*2) See "12.14.4 Starting with Active Frequency Matching".

*3) When 03 (detection speed) is selected, feedback input to input terminals A and B or feedback input to option P1-FB is required.

!

- If torque at starting is insufficient, it may improve by adjusting the Boost value at start [HC111], [HC112] or the Speed response [HA115]. See "12.9 Select the Appropriate Control Mode for the Motor and Load".
- If torque at starting is insufficient, it may improve by using the torque bias function. See "12.11.6 Torque Bias Function Settings".

12.14.9 Starting with Servo Lock

Q

- I want to stop the motor at predetermined place so that it is not move by external force, and then start driving again. for example traveling crane, etc.

A

- Before outputting the frequency to the motor, performs the servo-lock to stop the motor rotating. And then, start operation.
 - To apply servo-lock control, the following settings are required:
 - [AA121] Control mode (see the right section)
 - Set [AF101] DC braking selection to 01
 - Set [AF102] Braking type selection to 01 or 02.
 - Set [AF109] DC braking active time at start to other than 0.0
 - If the servo-lock control is enabled, servo-lock control is performed after the RUN command is given, for the period of time set as the DC braking active time at start [AF109].
- Example of a case where the servo-lock control at starting is enabled.

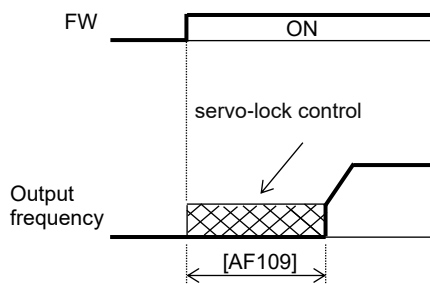

!

- The carrier frequency during servo-lock is depending on the Carrier frequency setting [bb101], however it may automatically drop to 2 kHz depending on the the required lock torque.
- To use servo lock control, the Control mode selection [AA121] should be set appropriately. If the following control mode is not selected, it is operate as DC braking mode regardless of the [AF102] setting.

(1) When the Braking type selection [AF102] is set to 01: Speed servo-lock

No.	[AA121] Control mode selection
1	09: Zero-Hz-range sensorless vector control (IM)
2	10: Vector control with encoder (IM)

(2) When the Braking type selection [AF102] is set to 02: Position servo-lock

No.	[AA121] Control mode selection
1	10: Vector control with encoder (IM)

- For [AA121] Control mode and [AA123] Vector control mode, see "12.9 Select the Appropriate Control Mode for the Motor and Load".
- The output of the servo-lock control is automatically calculated according to the selected control mode.
- Since the DC brake only outputs the braking force, the speed or position may continue to drift when external force is applied continuously. On the other hand, the speed servo lock controls to keep 0 speed even if external force is applied. In addition, the position servo lock controls so that it stays at the stop position even if external force is applied, which is useful in the absolute position control mode.

■ Parameters.

Name	Code	Data range (unit)	Description
DC braking selection, 1st-motor	[AF101]	00	Internal DC braking: Disabled
		01	Internal DC braking: Enabled
		02	Internal DC braking: Enabled (The braking operates only with the set braking frequency.)
Braking type selection, 1st-motor	[AF102]	01	Enables the speed servo-lock.
		02	Enables the position servo-lock.
DC braking active time at start, 1st-motor	[AF109]	0.00 to 60.00 (s)	Valid when the internal DC braking is enabled. Starts the servo-lock when the RUN command is turned on.
Control mode selection, 1st-motor	[AA121]	08	Sensorless vector control (IM)
		09	Zero-Hz-range sensorless vector control (IM)
		10	Vector control with encoder (IM)

12.15 Each Stop Mode Settings

12.15.1 Stop Mode Selection



- How to shut down the output without decelerating the motor because a moment of inertia is so large that it causes overvoltage.
- How to shut down the inverter output immediately because the mechanical brake is used to stop the motor.



- If [AA115]=01 free-run stop is selected, the output will be shut off when the RUN command is turned off.



- Use the Stop mode selection [AA115] to select one of the two methods of stopping the motor when the RUN command is turned off. One is to stop the motor according to the deceleration time; the other is to immediately cut off the output to shut down.
- If a free-run stop is to be input from a terminal, assign 032 [FRS] to an input terminal, and turn on the terminal.

- If the free-run stop is selected, the restart when a RUN command is given the next time follows the selection of the Restart mode after FRS release [bb-40].

■ Parameter.

Name	Code	Data range (unit)	Description
STOP mode selection, 1st-motor	[AA115]	00	Normal stop (deceleration → stop)
		01	Free-run stop
Restart mode after FRS release	[bb-40]	00	Restart at 0Hz
		01	Restart with matching frequency *1)
		02	Restart with active frequency matching *2)
		03	Detect speed *3)
Input terminal selection	[CA-01] to [CA-11]	032	Uses the Free-run stop function [FRS].

* 1) See "12.14.3 Starting with Frequency Matching".

*2) See "12.14.4 Starting with Active Frequency Matching".

*3) When 03 (detection speed) is selected, feedback input to input terminals A and B or feedback input to option P1-FB is required.

■ When free-run stop is selected. [AA115]=01

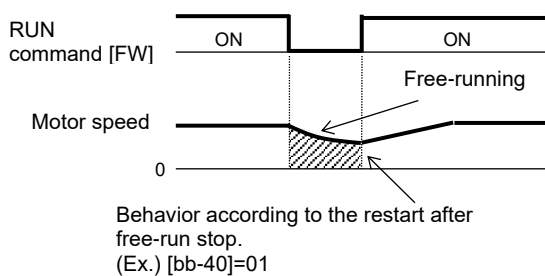

■ When the [FRS] terminal is used.

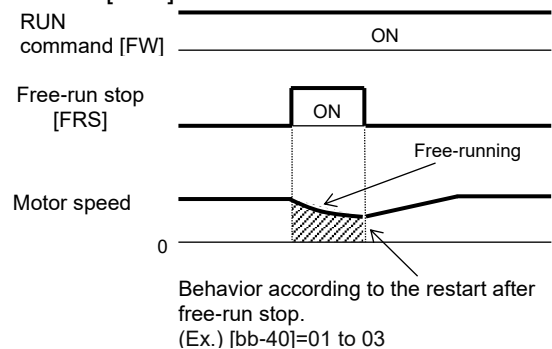

12.15.2 Stopping with DC Braking

Q

- How to stop the motor when a large moment of inertia makes it continue rotating even after deceleration stop.

A

- To use DC braking for stopping, the following settings are required.
 - Set [AF101] DC braking selection to 01.
 - Set [AF102] Braking type selection to 00.
 - Set [AF105] DC braking force setting.
 - Set [AF106] DC braking active time at stop to other than 0.0.
- To use DC braking with frequency command, the following settings are required.
 - Set [AF101] DC braking selection to 02.
 - Set [AF102] Braking type selection to 01 or 02.
 - Set [AF103] DC braking frequency to other than 0.00.
 - Set [AF105] DC braking force setting.
 - Set [AF106] DC braking active time at stop to other than 0.0.



- The carrier frequency during DC braking depends on [bb101], but it is limited to at maximum 5 kHz. Depending on the set braking force, the carrier frequency may automatically go down to 2 kHz.
- When the motor is stopped by using input terminal function 030 [DB] External DC braking, an overcurrent error or overvoltage error may occur if the output frequency is high or the high-inertia load.

Parameters.

Name	Code	Data range (unit)	Description
DC braking selection, 1st-motor	[AF101]	00	Internal DC braking: Disabled.
		01	Internal DC braking: Enabled.
		02	Internal DC braking: Enabled. (The braking operates only with the frequency reference.)
Braking type selection, 1st-motor	[AF102]	00	Enables the DC braking.
DC braking frequency, 1st-motor	[AF103]	0.00 to 590.00(Hz)	With internal DC braking enabled, DC braking is started when the output frequency becomes below this frequency.
DC braking delay time, 1st-motor	[AF104]	0.00 to 5.00(s)	Specifies the delay in starting DC braking while temporarily shutting off the output.
DC braking force setting, 1st-motor	[AF105]	0 to 100(%) (Might be internally limited)	Adjusts the DC braking force. When "0%" is specified, no braking operation will be performed.
DC braking active time at stop, 1st-motor	[AF106]	0.00 to 60.00(s)	Sets the duration for DC braking. This setting is valid when the [DB] terminal is edge input or for the internal DC braking. When "0.00 s" is specified, no braking operation will be performed.
DC braking operation method selection, 1st-motor	[AF107]	00	Edge mode.
		01	Level mode.
Input terminal function	[CA-01] to [CA-11]	030	DC braking is enabled by using the [DB] terminal. OFF: DC braking is disabled. ON: DC braking is enabled.

■ DC braking at stopped.



- To use the DC braking for stopping, set [AF101] DC braking selection to 01, [AF102] Braking type selection to 00, [AF106] DC braking active time at stop to other than 0.00 s, and [AF105] DC braking force setting to any value. When the frequency output is shut off, DC braking is applied.
- The braking force is adjusted at the [AF105] DC braking force setting.
- When the DC braking delay time [AF104] is set and the decelerated frequency after the RUN command is turned OFF below the DC braking frequency [AF103], the frequency output is cut off and DC braking is started after the set time [AF104].



- The DC braking behaviour when the RUN command changes from STOP to RUN differs depending on the edge or level selection in the DC braking operation method selection [AF107].
- When setting the DC braking force setting [AF105] and the DC braking active time at stop [AF106], pay attention to the heat generation on the motor.

■ Edge mode: [AF107]=00.

DC braking active time at stop [AF106] is given priority, and the inverter performs DC braking for the time set for [AF106]. After the RUN command is turned off, if the output frequency falls below [AF103] DC braking frequency, DC braking will be applied for the time set for [AF106]. Even if the RUN command is turned on during DC braking, DC braking continues until the time set for [AF106] elapses. (Ex. 1), (Ex. 2)

■ Level mode: [AF107]=01.

RUN command is given priority. The inverter ignores the DC braking active time at stop [AF106] and transits to the normal operation. If the RUN command is turned on during DC braking, the inverter ignores the time set for [AF106] and returns to the normal operation. (Ex. 3), (Ex. 4)

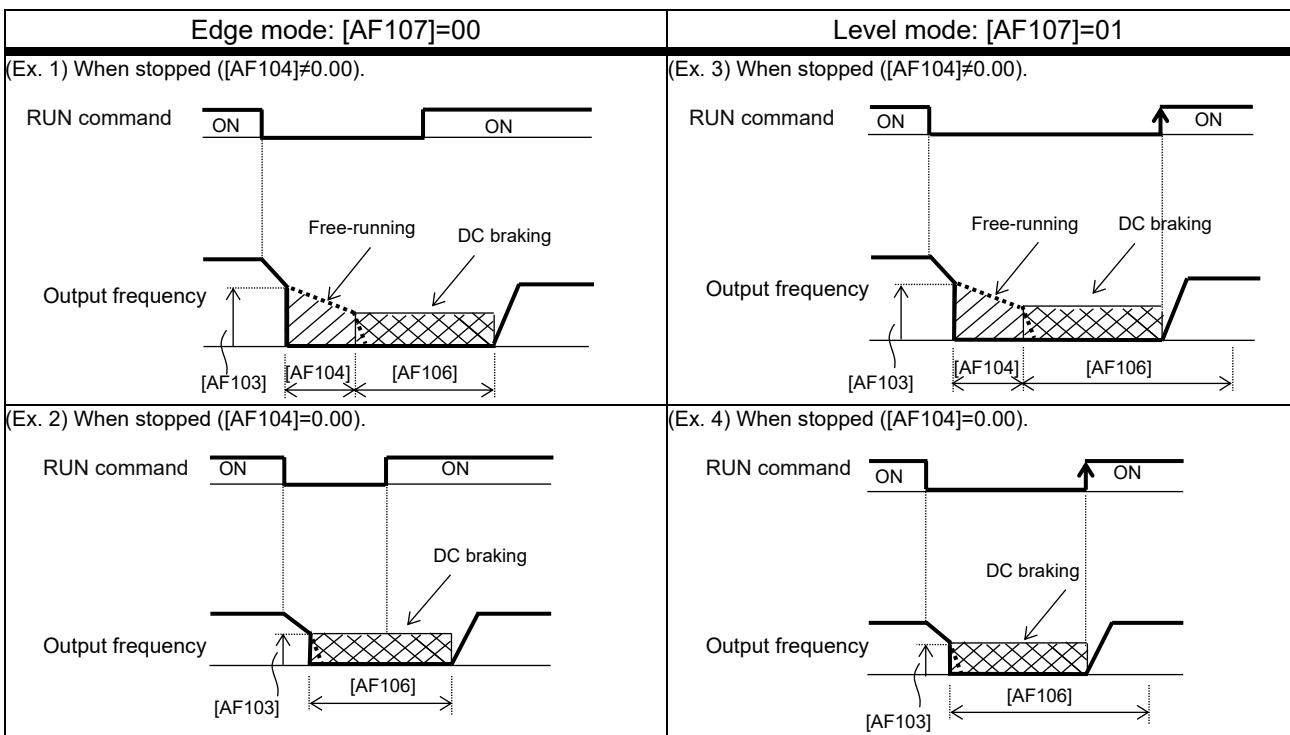

■ DC braking with frequency reference



- To use the DC braking with frequency reference, set the DC braking selection [AF101] to 02, and the DC braking active time at stop [AF106] to other than 0.0 s. DC output can be started by changing the frequency reference.
- The inverter starts DC braking when both the frequency reference and the output frequency fall to [AF103] or below. (Ex. 5)
- This function operates only when the RUN command is ON.

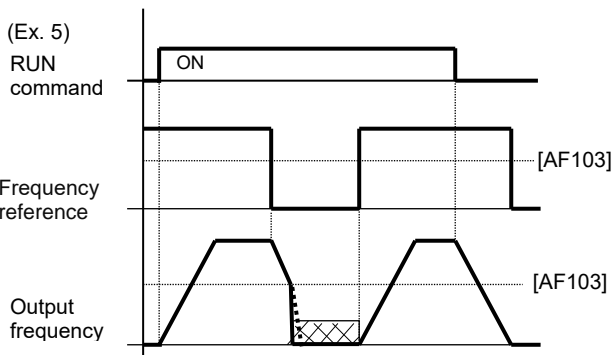

- If the RUN command is turned on after the frequency reference is established (where a value larger than [AF103]+2 Hz is input), the inverter is started with the normal output.
- When the starting frequency is "0 Hz" due to the frequency reference input source is analog input, etc., the DC braking is applied at the start because both the frequency reference and the output frequency are "0 Hz". (Ex. 6)

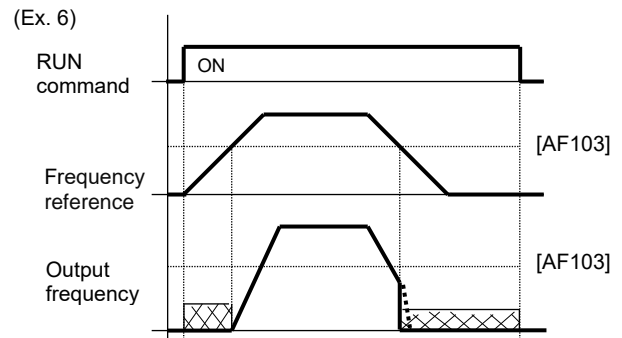

- How the inverter returns to the normal operation varies depending on the setting of the DC braking operation method selection [AF107].
- When "00" is set for [AF107], the inverter returns to the normal operation after the DC braking active time at stop [AF106] is elapsed. (Ex. 7)

- When "00" is set for [AF107], the inverter starts acceleration when the frequency reference exceeds [AF103]+2 Hz. (Ex. 8)

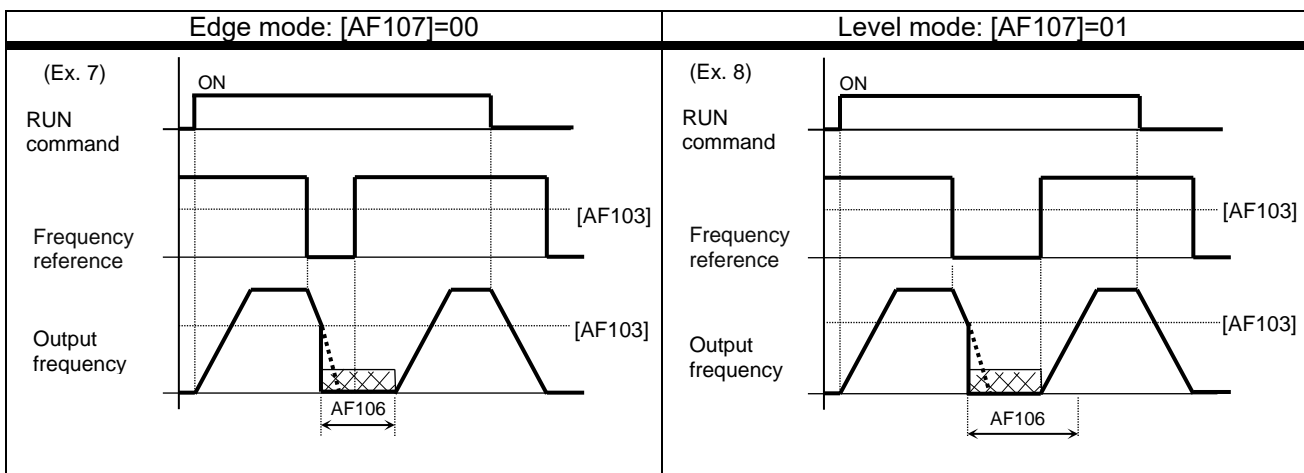

- The following applies When the DC braking with frequency reference is enabled:
 - The input terminal function 030 [DB] External DC braking is invalid;
 - The [AF102] setting is invalid, and it operates with [AF102] = 00 (DC braking).

■ DC braking using the input terminal function.

A

- Assign 030 [DB] External DC braking to input terminal functions [CA-01] to [CA-11].
- When [AF101]=00 or 01, DC braking is applied depending on whether the [DB] terminal is on or off.
- Adjust the braking force by adjusting the DC braking force setting [AF105].
- When the DC braking delay time [AF104] is set, during the set time, the inverter output is shut off and the motor is in free running. (Ex. 11), (Ex. 14)
- DC braking is started after the set period [AF104] is elapsed.
- Select the braking mode by the DC braking operation method selection [AF107], and then make any other necessary settings suitable for your system.
- When [AF107]=00(edge mode): by ON edge input of [DB], the inverter performs DC braking for the time set for [AF106]. (Example 9) to (Example 11)
- When [AF107]=01(level mode): The inverter performs DC braking while [DB] is on. (Ex. 12) to (Ex. 14)



- When setting the DC braking force setting [AF105], the DC braking active time at stop [AF106], or the ON time of the input terminal function 030 [DB], pay attention to the heat generation on the motor.
- The setting for the [DB] terminal is given priority over RUN commands. (Ex. 9), (Ex. 12)
- If the [DB] terminal is turned on when the motor speed is high, an overcurrent error or an overvoltage error may occur.
- When the setting of the DC braking selection [AF101] is 02(Frequency reference), the external DC braking by [DB] terminal input is invalid.

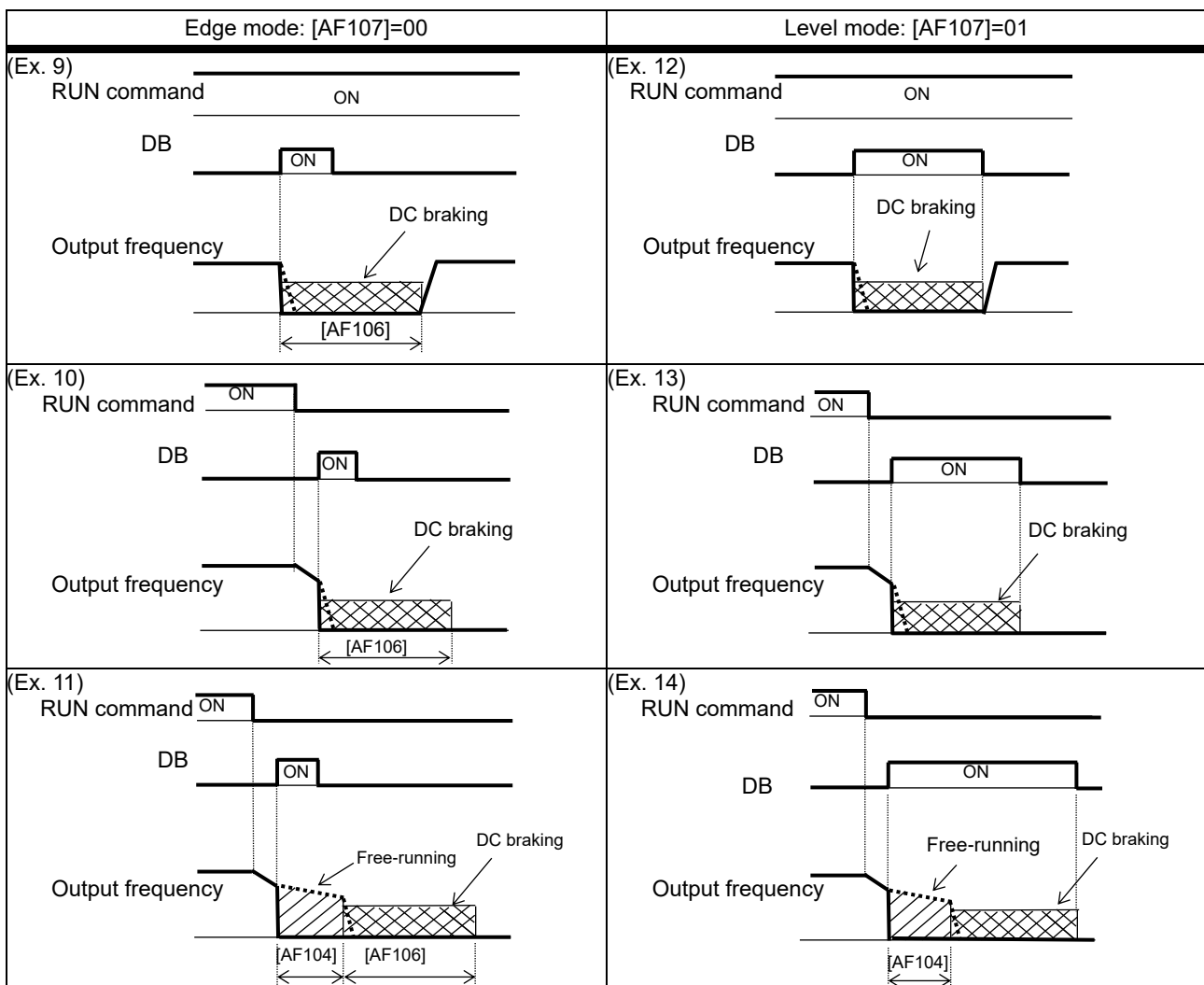

12.15.3 Stopping with Servo-Lock

Q

- How to stop the motor when a large moment of inertia makes it continue rotating even after deceleration stop.
- How to stop the motor at a fixed position.

!

- The carrier frequency during servo-lock depends on [bb101], but it is limited to at maximum 5 kHz. Depending on the servo-lock force, the carrier frequency may automatically go down to 2 kHz.
- To use the servo-lock control, it is necessary to set [AA121] Control mode selection. If the corresponding control mode is not selected, the inverter assumes that the [AF102] setting is 00 (DC braking)

(1) When [AF102] Braking type selection is set to 01: Speed servo-lock.

No.	[AA121] Control mode selection
1	09: Zero-Hz-range sensorless vector control (IM)
2	10: Vector control with encoder (IM)

(2) When [AF102] Braking type selection is set to 02: Position servo-lock.

No.	[AA121] Control mode selection
1	10: Vector control with encoder (IM)

A

- To stop with servo-lock control, the following settings are required:
 - [AA121] Control mode selection (see the following).
 - Set [AF101] DC braking selection to 01.
 - Set [AF102] Braking type selection to 01 or 02.
 - Set [AF106] DC braking active time at stop to other than 0.0.
- To use the servo-lock control, it is necessary to set [AA121] Control mode selection. See "12.9 Select the Appropriate Control Mode for the Motor and Load".
- The output of the servo-lock control is automatically calculated according to the selected control mode.
- Since the DC braking only outputs the braking force, the speed or position may continue to drift when external force is applied continuously. On the other hand, the speed servo lock controls to keep 0 speed even if external force is applied. In addition, the position servo lock controls so that it stays at the stop position even if external force is applied, which is useful in the absolute position control mode.

Parameters.

Name	Code	Data range (unit)	Description
DC braking selection, 1st-motor	[AF101]	00	Internal DC braking: Disabled
		01	Internal DC braking: Enabled
		02	Internal DC braking: Enabled (The braking operates only with the frequency reference.)
Braking type selection, 1st-motor	[AF102]	01	Enables the speed servo-lock.
		02	Enables the position servo-lock.
DC braking frequency, 1st-motor	[AF103]	0.00 to 590.00(Hz)	With internal DC braking enabled, DC braking is started when the output frequency becomes below this frequency.
DC braking delay time, 1st-motor	[AF104]	0.00 to 5.00(s)	Specifies the delay in starting DC braking while temporarily shutting off the output.
DC braking active time at stop, 1st-motor	[AF106]	0.00 to 60.00(s)	Sets the duration for DC braking. This setting is valid for the [DB] terminal in edge mode or for the internal DC braking. When "0.00 s" is specified, no braking operation will be performed.
DC braking operation method selection, 1st-motor	[AF107]	00	Edge mode.
		01	Level mode.
Input terminal function	[CA-01] to [CA-11]	065	Controls with the servo-on mode using the [SON] terminal. OFF: Servo lock is disabled. ON: Servo lock is enabled.
Control mode selection, 1st-motor	[AA121]	08	Sensorless vector control (IM)
		09	Zero-Hz-range sensorless vector control (IM)
		10	Vector control with encoder (IM)

■ Servo-lock control at stopped.

A

- To use servo-lock control for stopping, set the Control mode selection [AA121] and DC braking selection [AF102] to 01, the Braking type selection [AF102] to 01 or 02, and the DC braking active time at stop [AF105] to other than 0.00 s. DC braking operates after the frequency output is shut off.
- When the DC braking delay time [AF104] is set, and if the RUN command is turned off and the decelerated frequency falls below the DC braking frequency [AF103], the output is shut off once, and after [AF104] is elapsed, DC braking is started.

!

- The operation to be performed when the RUN command is switched from the STOP to RUN varies depending on the setting of the DC braking operation method selection [AF107].
- When setting the DC braking active time at stop [AF106], pay attention to the heat generation on the motor.

■ Edge mode: [AF107]=00

The DC braking active time at stop [AF106] is given priority, and the inverter performs servo-lock control for the time set for [AF106]. After the RUN command is turned off, if the output frequency falls below the [AF103], servo-lock is applied for the time set for [AF106]. Even if the RUN command is turned ON, the servo lock is continued until the set time of [AF106] is elapsed. (Ex. 1), (Ex. 2).

■ Level mode: [AF107]=01

Run commands are given priority. The inverter ignores the [AF106] setting and transits to the normal operation. If the RUN command is turned on during servo-lock, the inverter ignores the time set for [AF106] and returns to the normal operation. (Ex. 3), (Ex. 4).

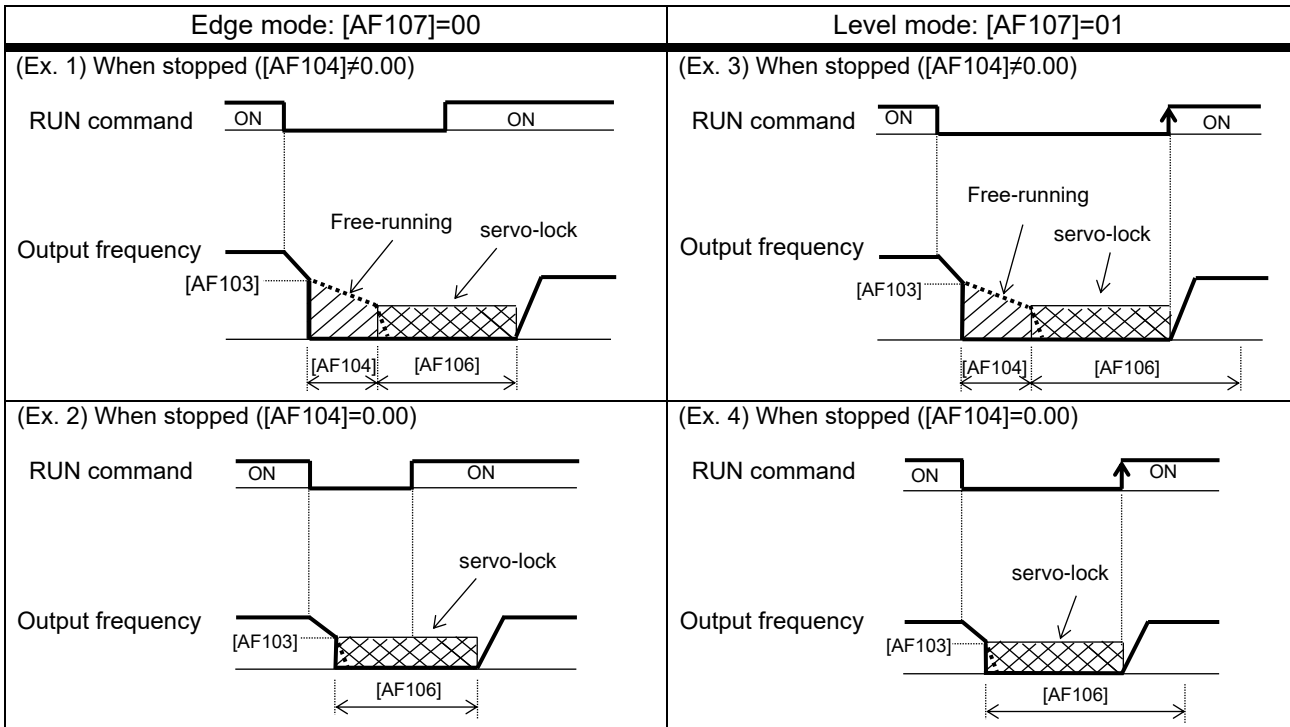

12.16 Using System Protection Functions

12.16.1 Detecting Input Phase loss



- How to prevent system failure due to unstable motor operation when a phase loss occurs by breakage of the input power cable.



- Enable the input phase loss protection function by using the Input phase loss detection enable [bb-65].
- When the input phase loss protection function has been enabled, an input phase loss error [E024] will occur if a phase loss state due to disconnection or breakage of the input power cable continues for 1 second or more.
- If an Input open-phase error [E024] occurs, it is necessary to cut off the power supply to the inverter and check the state of wiring and breakers.



- When 3-phase AC is not input to power supply terminals R, S, and T, such as in cases where DC bus voltage is input to R and T or between P and N of the inverter, this function is disabled regardless of the setting for [bb-65].
- This detection is not performed during an instantaneous power failure.

Parameters.

Name	Code	Data range (unit)	Description
Input phase loss detection enable	[bb-65]	00	Disabled
		01	Enabled

12.16.2 Detecting Output Phase loss

Q

- How to prevent system failure due to unstable motor operation because a phase loss occurs by breakage of the output cable to the motor.

A

- Enable the output phase loss protection function by using the Output phase loss detection enable [bb-66].
- When the output phase loss protection function has been enabled, an Output open-phase error [E034] will occur if a phase loss caused by disconnection or breakage of the motor cable continues.



- If the capacity of the drive motor is smaller than that of the inverter, the inverter may detect an output phase loss erroneously. In this case, decrease the value of [bb-67] or set [bb-66] to 00.
- If the carrier frequency [bb101] is low, the inverter may detect an output phase loss erroneously. It may improve by increasing the value of the carrier frequency [bb101].
- This function operates when the output frequency is between 5 Hz and 100 Hz.
- Set the value of [bb-67] equal to or lower than the steadily flowing current, with the rated current being 100%.

Parameters.

Name	Code	Data range (unit)	Description
Output phase loss detection enable	[bb-66]	00	Disabled
		01	Enabled
Output phase loss detection sensitivity	[bb-67]	1 to 100(%)	Adjusts the sensitivity of the output phase loss.
Carrier frequency setting, 1st-motor	[bb101]	200 V class P1-004L to P1-550L / 400 V class P1-007H to P1-550H: [Ub-03]= 02(ND): 0.5 to 16.0(kHz) 01(LD): 0.5 to 12.0(kHz) 00(VLD): 0.5 to 10.0(kHz) 400 V class P1-750H or larger: [Ub-03]= 02(ND): 0.5 to 10.0(kHz) 01(LD): 0.5 to 8.0(kHz) 00(VLD): 0.5 to 8.0(kHz)	Changes the carrier frequency.

12.16.3 Trip the Inverter Using an External Input Signal



- How to shut off the inverter output when an error occurs in the system.



- This function is enabled by setting 033 [EXT] External fault as an input terminal function. When a signal connected to the applicable terminal is turned on, an error [E012] occurs.
- Use this function when you want to trip the inverter via an error (trip) signal generated by a peripheral system.



- When the inverter trips with error code [E012] displayed, the trip of the inverter is not reset only even if the error signal from the external equipment is reset ([EXT] terminal is turned off). To reset this trip, reset the inverter or power off and on again.
- If the inverter is reset while the [EXT] terminal is on, [E012] is occur again.
- After the reset, the inverter follows the Restart mode after RS release [bb-41] setting. See "12.14.6 Starting After Reset".
- When the terminal [EXT] is turned on, an error will occur even if the inverter output is turned off, and the inverter trips with [E012] displayed.

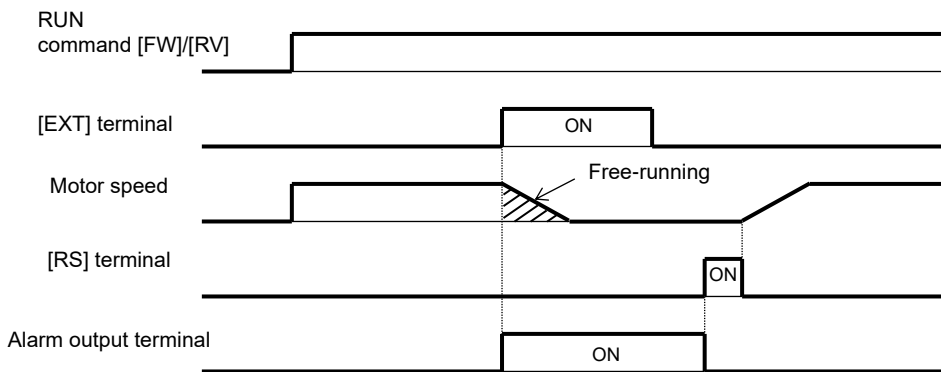

Name	Code	Data range (unit)	Description
Input terminal function	[CA-01] to [CA-11]	033	[EXT]: When the input terminal to which this function is assigned is turned on, an External trip error [E012] occurs.

12.16.4 Unattended Start Protection at Power On



- How to prevent the motor from starting rotation suddenly when the inverter power is turned on.
- How to stop with an error when the power supply is turned on again while the RUN command remains ON.



- Unlike other trips, the USP error [E013] is automatically released when the RUN command is turned off.
- The unattended start protection operates for up to 2 seconds after the control power supply is turned on.



- With this unattended start protection (USP), if the power supply to the inverter is on while the RUN command is on, the inverter is not started, a trip occurred, and the error code [E013] USP error is displayed.
- When the reset is turned on or the RUN command is turned off, the inverter release the trip. (Ex. 1)
- When the trip is released while the RUN command is ON, the inverter is started driving immediately after the trip is released. (Ex. 2)
- The inverter can operate normally when an RUN command is turned on after the inverter power supply is turned on. (Ex. 3)

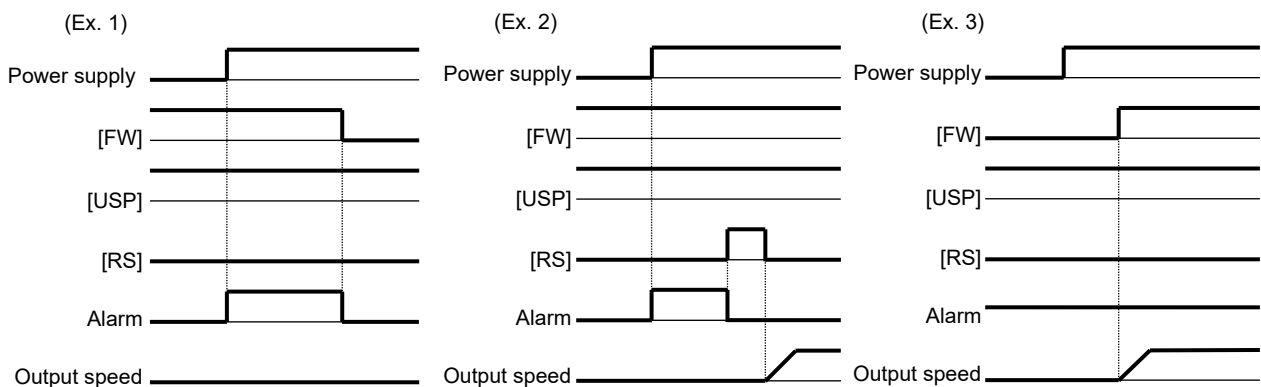

■ Parameter.

Name	Code	Data range (unit)	Description
Input terminal function	[CA-01] to [CA-11]	034	[USP]: If the applicable [USP] terminal assigned to an input terminal is turned on, the inverter is tripped when the power supply is recovered while RUN command is turned on.

12.16.5 Detecting Overcurrent Error

Q

- How to prevent overcurrent from flowing in the motor.
- How to lower the overcurrent protection threshold to prevent the magnet from demagnetizing when a magnetic motor is driven.

A

- By the setting of the Overcurrent detection level [bb160], the threshold current value used for detecting the Overcurrent error [E001] can be adjusted.

!

- If the threshold level for overcurrent is lowered, the overcurrent error [E001] is more likely to occur. Therefore, it is necessary to lower the levels for the overload restriction function and the overcurrent suppression function. For details, see "12.13 Functions to Prevent Trips or Restart on Trips".
- The Overcurrent detection level [bb160]/[bb260] is 0.2 to 2.2 times the normal duty (ND) rated current regardless of the Load type selection [Ub-03].

Parameters.

Name	Code	Data range (unit)	Description
Overcurrent detection level, 1st-motor	[bb160]	Inverter ND(normal duty) rated current × (0.2 to 2.2) (A)	Sets the threshold level used for detecting overcurrent.

12.16.6 Detecting Instantaneous Power Failure and Under-Voltage



- How to make the inverter trip when the power supply voltage of the inverter has dropped.
- How to stop the inverter with an error when an instantaneous power failure has occurred.



- When selecting a retry function, see "12.13 Functions to Prevent Trips or Restart on Trips".
- If the main CPU power supply and firmware of the inverter are stopped due to the cutoff of the control power supply, the operation after power on again is the same as the restart after reset. See "12.14.6 Starting after Reset" for details.



■ Parameters related to instantaneous power failure and under-voltage.

Item	Instantaneous power failure	Under-voltage
<ul style="list-style-type: none"> • The inverter is always tripped when an instantaneous power failure or under-voltage occurs. 	Set [bb-20] to 0. [E016] Instantaneous power failure error.	Set [bb-21] to 0. [E009] Under-voltage error.
<ul style="list-style-type: none"> • The inverter is always retried when an instantaneous power failure or under-voltage occurs. 	Set [bb-20] to 255.	Set [bb-21] to 255.
<ul style="list-style-type: none"> • The inverter is tripped after the specified number of retries, when an instantaneous power failure or under-voltage occurs. 	Set [b-20] to other than 0 or 255. [E016] Instantaneous power failure error.	Set [b-21] to other than 0 or 255. [E009] Under-voltage error.
<ul style="list-style-type: none"> • Outputting the state to an output terminal. 	Assigns 020 [IP] Instantaneous power failure to output terminal.	Assigns the 021 [UV] Under voltage to output terminal.
<ul style="list-style-type: none"> • Selection of whether to trip the inverter when an instantaneous power failure or under-voltage occurs while the inverter is in stop state. 	Set [bb-27].	



- When DC voltage (P-N) is supplied to control power supply terminal R0 and T0, the inverter may detect under-voltage at power interruption and then trip. If there is any problem with your system, set [bb-27] to 00 or 02.
- Even if Number of retries after instantaneous power failure [bb-20] is set to other than 0 and Enable instantaneous power failure/ under-voltage trip while in stop status [bb-27] is set to Disabled (00 or 02), [E016] Instantaneous power failure error is occurs if the actual power failure time exceeds the allowable instantaneous power failure time.
- Even during a retry operation, the retry is interrupted if the instantaneous power failure/under-voltage condition continues for about 40 seconds, and [E009] Under-voltage error or [E016] Instantaneous power failure error is occurred.
- When connecting separate power supplies to control power supply terminals (R0 and T0), and if an instantaneous power failure occurs at the main power supply terminals (R, S, and T), there is a detection delay of about 1 second before an instantaneous power failure error or under-voltage error occur.
In this case, if braking is performed by output terminal function 017 [AL] alarm signal, the braking response is slowed, therefore use the brake control function instead.
See "12.17.4 External Mechanical Brake Control Settings" for details.

■ Parameter

Name	Code	Data range (unit)	Description
Number of retries after instantaneous power failure	[bb-20]	0 to 16 / 255	Detects a decrease in the control power supply and restarts the motor when the power supply is recovered. When 0 is specified, the inverter immediately trips when an instantaneous power failure occurs. If 255 is set, the retry count limit is unlimited.
Number of retries after under voltage	[bb-21]	0 to 16 / 255	Detects a decrease in the main power supply and restarts the motor when the power supply is recovered. When 0 is specified, the inverter immediately trips when an under-voltage condition occurs. If 255 is set, the retry count limit is unlimited.
Restart mode selection after instantaneous power failure/under-voltage error	[bb-24]	00	Restarts at 0 Hz
		01	Restart with frequency matching
		02	Restart with active frequency matching
		03	Detect speed (Supported Ver 2.00 or higher)
		04	Decelerate and stop with frequency matching and then trip.
Instantaneous power failure allowed time	[bb-25]	0.3 to 25.0 (s)	Restarts if the instantaneous power failure is within the set time. Trips if the instantaneous power failure exceeds the specified time.
Retry wait time after instantaneous power failure/under-voltage error	[bb-26]	0.3 to 100.0 (s)	Sets the time before restarting.
Enable instantaneous power failure/ under-voltage trip while in stop status	[bb-27]	00	Disabled
		01	Enabled
		02	Disabled during stopping and during deceleration stop after the RUN command has been turned off.
output terminal function	[CC-01] to [CC-07]	017 020 021	017: [AL] Alarm signal. 020: [IP] Instantaneous power failure signal 021: [UV] Under-voltage signal.

■ Alarm output when instantaneous power failure/under-voltage occurs during stopping.



- By setting [bb-27], it is able to select whether output terminal function 017 [AL] alarm signal is output when an instantaneous power failure/under-voltage occurs while the inverter is in stop.
- Examples 1 to 6 are examples when retry operation is not performed.



- When the power to control power supply terminals R0 and T0 is supplied from main power supply terminals R, S, and T, and if the control power supply terminals continue to be shut off for 80 ms or more, it is judged that the power supply is cut off. After the power supply is recovered, the inverter performs same as start at power-on.
- Depending on the load conditions of the motor, an under-voltage error [E009], instead of an instantaneous power failure error [E016], may occur.
- The inverter outputs the alarm while the power to control power supply terminals R0 and T0 remains.

■ Examples of supplying the power to R0 and T0 from R, S, and T.

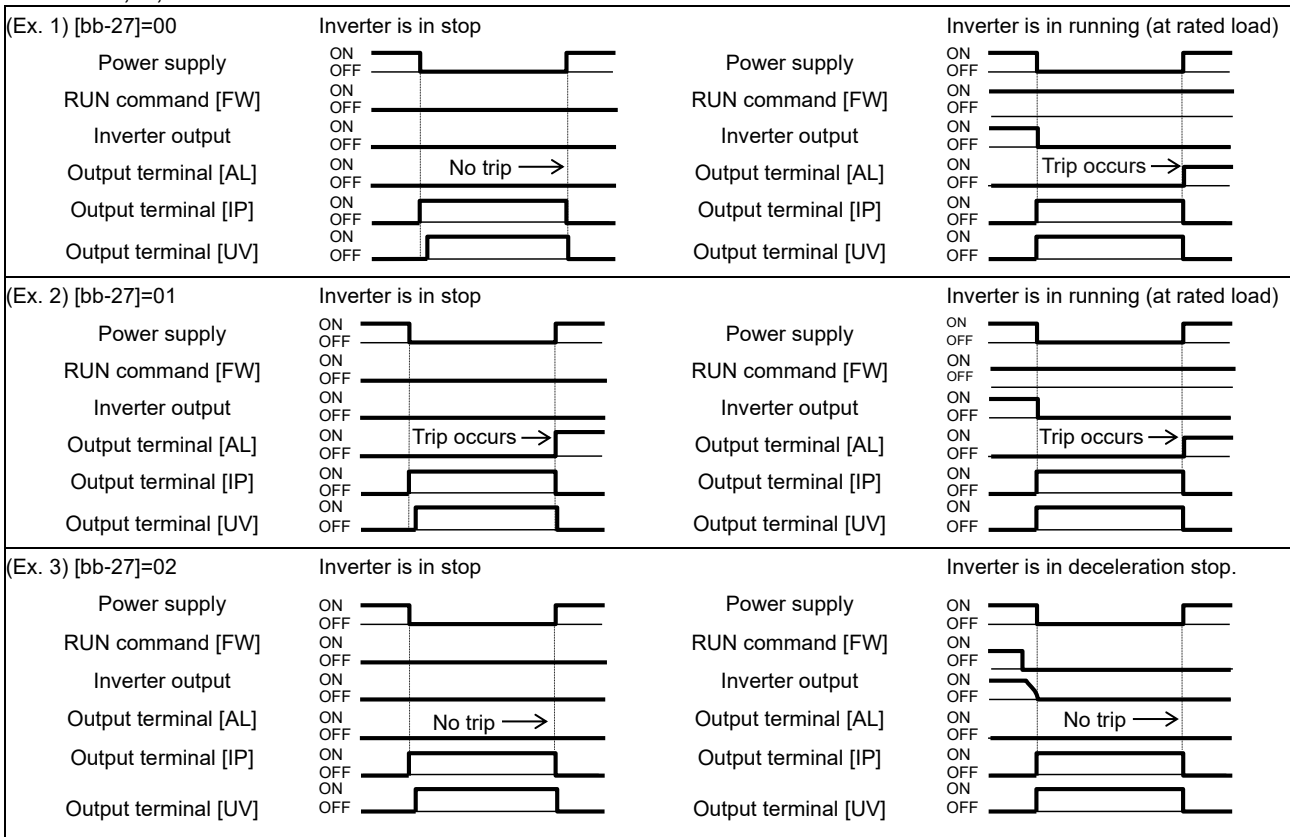



- Depending on the setting for [bb-25] instantaneous power failure allowed time and the setting of the number of retries, the inverter's behavior varies.
- When "0" is set to the number of retries (Error occurs):
 - Power recovery within [bb-25];
⇒ An error will be occurred.
 - Power recovery after [bb-25] is elapsed;
⇒ An error will not be occurred. The behavior of the inverter when the power recovered is same as start at power on.
- When other than "0" is set to the number of retries (Retry enabled);
 - Power recovery within [bb-25];
⇒ Trip retry operation.
 - Power recovery after [bb-25] is elapsed;
⇒ An error will be occurred.

■ Examples of supplying the power to R0 and T0 from P and N.

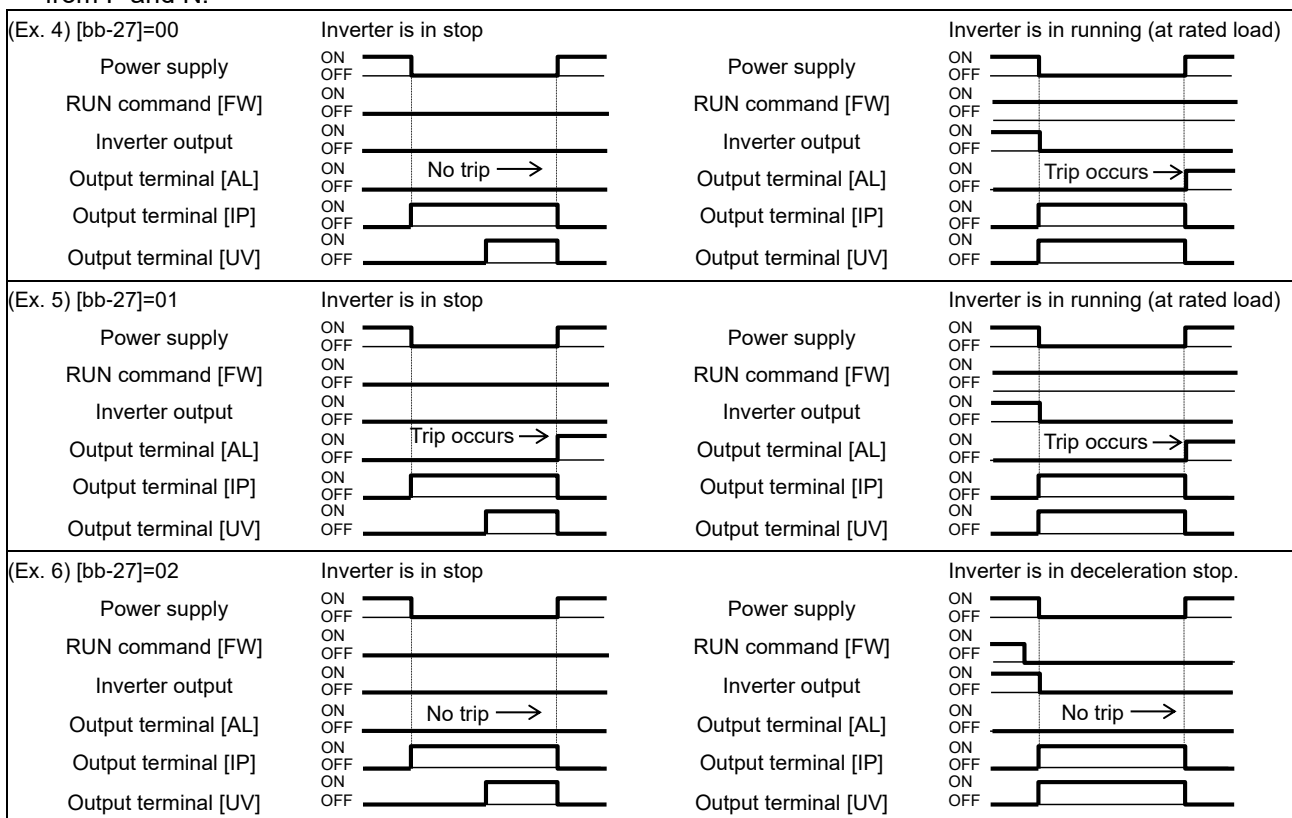

- The [IP] signal is detected after the input of the three-phase power supply is confirmed at the main power supply R, S, and T terminals.
- If DC voltage is directly supplied between P and N, the [IP] signal is not output.

12.16.7 Avoiding Mechanical Resonance of Motor and Machine



- How to avoid the motor or machine vibrating when the motor is installed in the system and driven at a certain speed.



- The jump frequency function is a function to prevent output within the specified frequency reference range. When a frequency reference that is within the range of the jump frequency function is input, the output is automatically limited. While the output is limited, the LIM icon is displayed.



- The jump frequency function is used when operating while avoiding the resonance point of the load mechanical system.
- There are three jump frequency settings.

- The output frequency within the range of the jump frequency settings fluctuates continuously according to normal the acceleration/deceleration time.

■ Parameters.

Name	Code	Data range (unit)	Description
Jump frequency 1, 1st-motor	[AG101]	0.00 to 590.00(Hz)	Sets the center of the frequency range at which to execute a jump. If 0.00 Hz is set, the jump frequency function is disabled.
Jump frequency 2, 1st-motor	[AG103]		
Jump frequency 3, 1st-motor	[AG105]		
Jump frequency width 1, 1st-motor	[AG102]	0.00 to 10.00(Hz)	Set one-half of the frequency width in which to execute a jump. Frequencies that fall in the range of a jump frequency±jump width is jumped.
Jump frequency width 2, 1st-motor	[AG104]		
Jump frequency width 3, 1st-motor	[AG106]		

■ Setting examples.

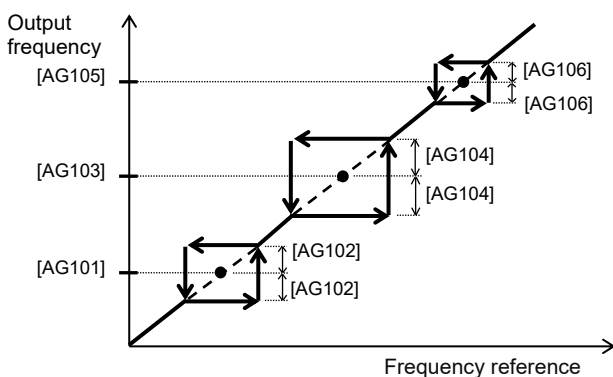

12.16.8 Detecting Speed Deviation Error

Q

- How to check whether the system is driving at the reference speed.
- How to generate an error signal when the motor is not controlled at the reference speed.

!

- To use this function, feedback input to input terminals A and B or feedback input to option P1-FB is required.

A

- The speed deviation error detection function judges that the deviation is excessive if the deviation between the frequency reference and the feedback speed becomes large.
- This function operates when the Speed deviation error detection level [bb-83] is set to other than "0.0".
- Speed deviation is the difference between the Output frequency monitor (signed) [dA-12] and the Detect speed monitor [dA-08].
- When the absolute value of speed deviation is exceeded the Speed deviation error detection level [bb-83], and then the Speed deviation error detection time [bb-84] is elapsed, it is judged as a speed deviation error.
- If "00: Warning" is specified for [bb-82] Speed deviation error mode selection, the inverter turns on the output terminal function 041 [DSE] with a speed deviation error.
- If "01: Error" is specified for [bb-82] Speed deviation error mode selection, the inverter turns on the output terminal function 041 [DSE] with a speed deviation error, and trips with [E105] Speed deviation excessive error.

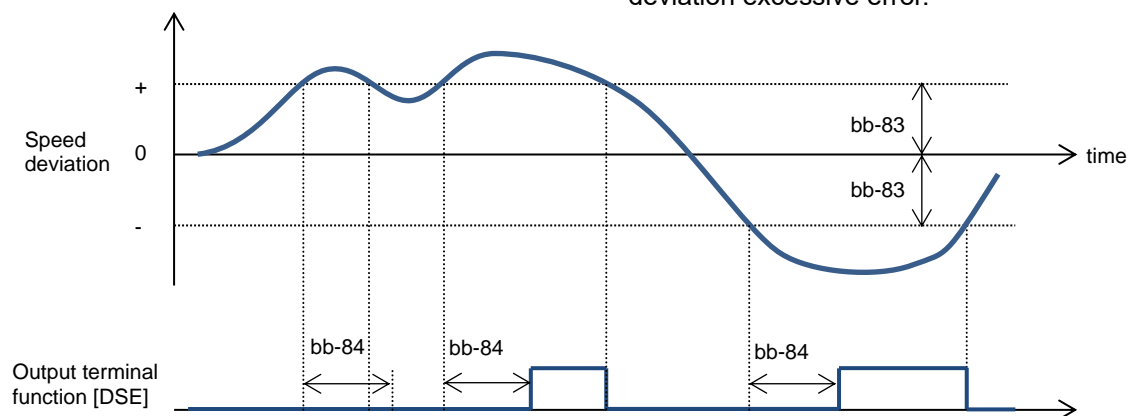

■ Parameters.

Name	Code	Data range (unit)	Description
Speed deviation error mode selection	[bb-82]	00	Turns on the output terminal function 041 [DSE] as warning.
		01	Turns on the output terminal function 041 [DSE], and trips with [E105] Speed deviation excessive error.
Speed deviation error detection level	[bb-83]	0.0 to 100.0(%)	Sets the speed deviation error detection level at the ratio with the maximum frequency as 100%.
Speed deviation error detection time	[bb-84]	0.0 to 5.0(s)	Sets the time to judge the deviation to be an error after it has excessively increased.
Detect speed monitor	[dA-08]	-590.00 to 590.00(Hz)	Displays data obtained through encoder feedback.
Output frequency monitor (signed)	[dA-12]	-590.00 to 590.00(Hz)	Displays the frequency referene given by the inverter.

12.16.9 Detecting Over-Speed Error



- How to monitor whether the motor is rotating at below the maximum speed.
- How to output an error signal when the rotation speed of the motor exceeds the allowable speed of the system.



- To use this function, feedback input to input terminals A and B or feedback input to option P1-FB is required.



- The over-speed error detection function judges that the speed is excessive if the feedback speed exceeds the over-speed level.
- This function operates when the Over-speed detection level [bb-80] set to other than "0.0".

- Whether the speed is excessive is determined according to the feedback frequency displayed on the Detect speed monitor [dA-08].
- When the speed is exceeded the Over-speed detection level [bb-80], and then Over-speed detection time [bb-81] is elapsed, it is judged as an over-speed error.
- When an Over-speed error occurs, the inverter trips with [E107].

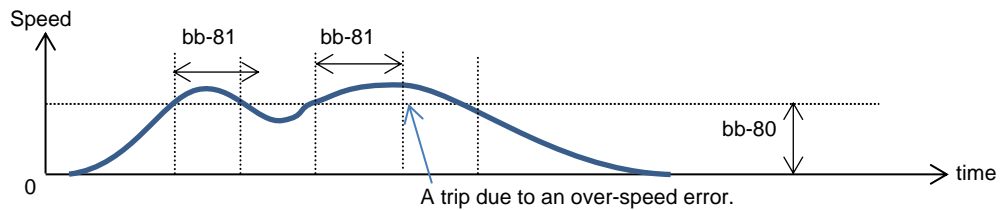

■Parameters.

Name	Code	Data range (unit)	Description
Over-speed detection level	[bb-80]	0.0 to 150.0(%)	Sets the overspeed detection level at the ratio with the maximum frequency as 100%.
Over-speed detection time	[bb-81]	0.0 to 5.0(s)	Sets the time to judge the speed to be an error after it has excessively increased. The inverter trips with [E107] Over-speed error.
Detect speed monitor	[dA-08]	-590.00 to 590.00(Hz)	Displays the data obtained through encoder feedback.

12.17 How to Use the Functions

Interlock to the System

12.17.1 Switching the Control of Two Motors



- How to drive two types of motors with different settings.
- How to retain the settings for two types of motors separately.
- How to change the settings all together for a batch production, etc.



- This function changes the valid parameters by assigning 024 [SET] to the input terminal function and turning it on. In conjunction with [SET], the output terminal 012 [SETM] is turned on.
- The following is the notation for the parameters that are changed with the [SET] terminal.

■ Example of the Common Settings.

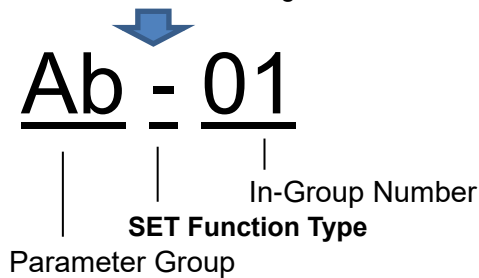

- The [SET] terminal can be switched while the output of the inverter is blocked. If it is being switched during the output, it is switched after the output blockage.
- Even if you want to switch the [SET] terminal for immediate operation, take more than 1 s for the switching time.

■ Example of the First Setting.

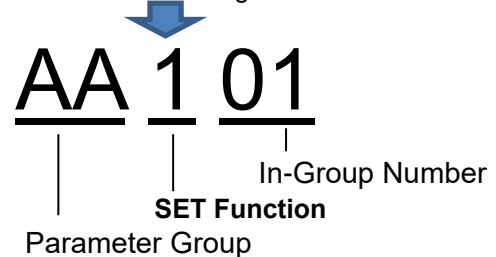

■ Example of the Second Setting.

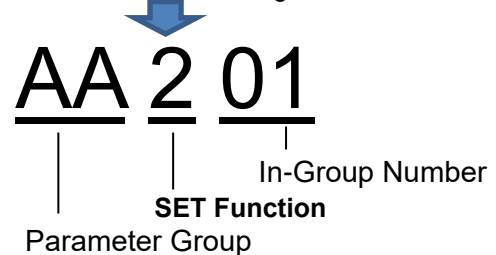

Example)	SET Function Type Notation	Description
Common	The third digit of the parameter is "-": [Ab-01], [bA-30], [CC-01], etc.	The parameter is common to the first and second settings regardless of the SET function. Always valid.
First setting	The third digit of the parameter is "1": [AA101], [bC112], [Hb102], etc.	If the [SET] terminal is off or the [SET] function is not assigned (off), the first setting is applied. The data for which the third digit of the parameter is "1" are all valid.
Second setting	The third digit of the parameter is "2": [AA201], [bC212], [Hb202], etc.	If the [SET] terminal is on, the second setting is applied. The data for which the third digit of the parameter is "2" are all valid.

■ Parameters.

Item	Parameter	Data	Description
Input terminal function	[CA-01] to [CA-11]	024	[SET]: 2nd-motor control. OFF: The first setting is valid. ON: The second setting is valid. *) If the parameter does not have 024[SET] assigned, the first setting is valid.
Output terminal function	[CC-01] to [CC-07]	012	[SETM]: 2nd-motor control is selected. OFF when [SET] is OFF; ON when [SET] is ON. *) Even if [SET] is turned ON while the inverter is in running, [SETM] is not turned ON because it is not switched to the 2nd control. [SETM] turns ON after switching to the 2nd control by turning [SET] ON when the inverter is in stop state.

12.17.2 Switching to Commercial Power Supply (Commercial Switching)



- How to start the motor with the inverter and drive it with a commercial power supply.
- How to switch between the drive with a commercial power supply and drive with the inverter.



- This function can be used to drive the acceleration/deceleration with the inverter and drive in a constant speed with a commercial power supply for a system where the load inertia moment is large.
- If the 035[CS] terminal is turned from on to off with the status when a RUN command is ON, the inverter starts with the frequency matched with the motor rotation speed in free-running after the retry wait time [bb-26]. (Starting the frequency matching.)



- The operation at the [CS] terminal is similar to the case when starting the frequency matching is selected. Starting at 0 Hz may occur when:
 - The output frequency is equal to or less than one-half of the base frequency;
 - The induced voltage of the induction motor decays early;
 - The frequency matching minimum restart frequency [bb-42] is set and a speed not more than the set speed is detected.
- For the frequency matching, extend the retry wait time [bb-26] when the overcurrent trip occurs.
- The operation can be also restarted automatically when the power is turned on. In this case, the reset restart function is used. See "12.14 Each Start Mode Settings" for details.

- For the behavior of the commercial switching, refer to the following sample connection diagram for the commercial switching operation and timing.
- Use light electrical relays for FWY, RVY, and CSY. The following sequence is a reference diagram for timing.
- Take a mechanical interlock for MC3 and MC2. Otherwise, you run the risk of damage to the inverter.
- Since the commercial circuit does not operate either when the earth leakage circuit breaker (ELCB) trips, connect the commercial circuit of another system to MC2 if the backup is required.

Sample connection diagram for the commercial switching operation and timing

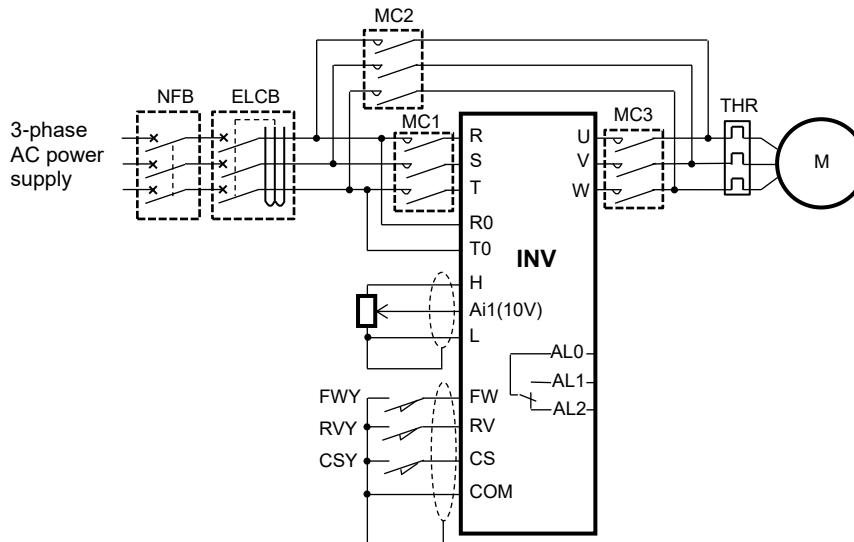

■ Example of timing from INV to the commercial operation.

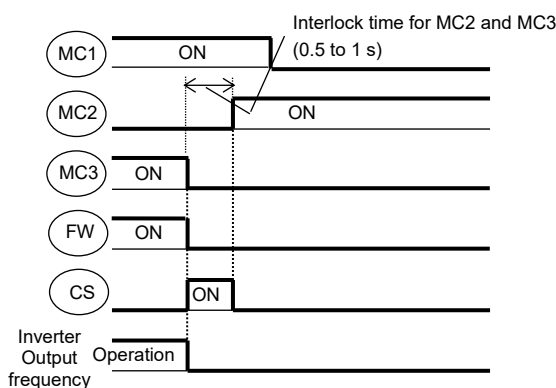

■ Example of timing from the commercial operation to INV

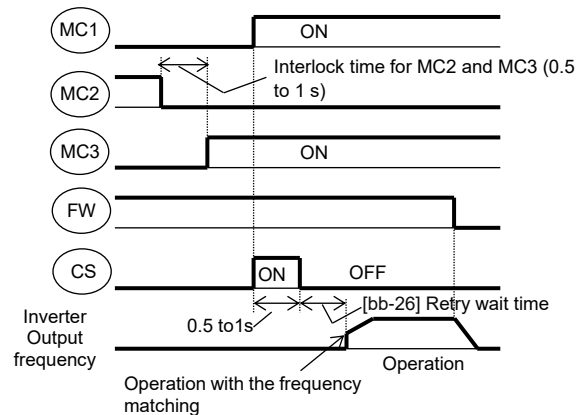

■ Parameters.

Name	Code	Data range (unit)	Description
Input terminal function	[CA-01] to [CA-11]	035	[CS]:Commercial Supply change. Used for the commercial power supply switching.
Retry wait time after instantaneous power failure/under-voltage error	[bb-26]	0.3 to 100.0(s)	Set the waiting time after [CS] is released.
Frequency matching minimum restart frequency	[bb-42]	0.00 to 590.00(Hz)	Starting at 0 Hz when the detected value is equal to or less than the set value.

12.17.3 Jogging/Inching Driving Settings



- How to drive a motor gradually.
- How to perform an inching operation.



- This function allows fine adjustment of the position when the motor is stopped.

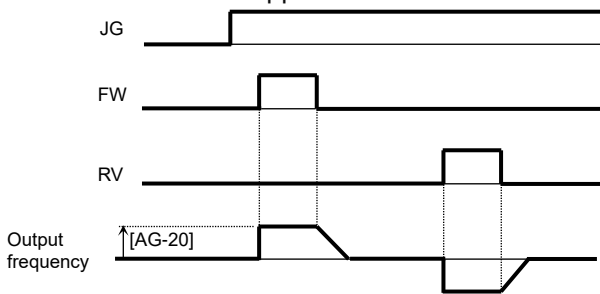

- Jogging operation is easy to trip because it has no acceleration time. Adjust the setting value for the jogging frequency [AG-20] so that the inverter does not trip.
- For the jogging operation, set the [AA111] RUN command input source selection to 00, turn on the 029[JG] terminal and then put the [FW]/[RV] terminal. The operation is not allowed with the [JG] terminal alone.
- When [AG-21] = 00, 03 for the free-running at the time of the stop, the operation settings for free-running is required.
- When [AG-21] = 02, 05 for the DC-braking at the time of the stop, the settings for the DC-braking function is required. Refer to "12.15 Each Stop Mode Settings" respectively.

Parameters.

Name	Code	Data range (unit)	Description
Jogging frequency	[AG-20]	Minimum frequency to 10.00 (Hz)	Frequency command at the time of the jogging operation command.
Jogging stop mode selection	[AG-21]	00	Invalid when the inverter is in running. And Free run when jogging stopped.
		01	Invalid when the inverter is in running. And decelerating stop when jogging stopped.
		02	Invalid when the inverter is in running. And DC braking operates when jogging stopped.
		03	Valid when the inverter is in running. And Free run when jogging stopped.
		04	Valid when the inverter is in running. And decelerating stop when jogging stopped.
		05	Valid when the inverter is in running. And DC braking operates when jogging stopped.
Input terminal function	[CA-01] to [CA-11]	029	When the [JG] terminal function is turned on, the jogging behavior occurs at the time of operation.

(Example 1)

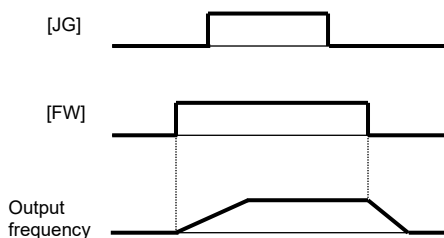

When the setting for [AG-21] is 00, 01 or 02, the jogging behavior does not occur if the [FW] signal is turned on first.

(Example 2)

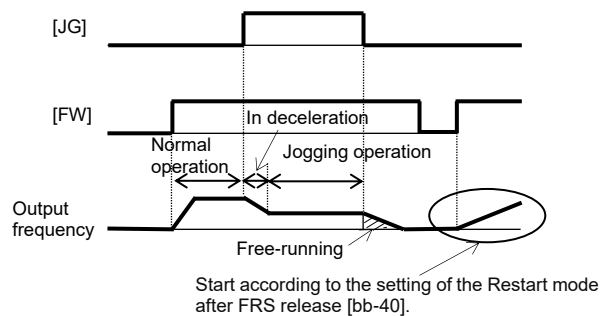

When the setting for [AG-21] is 03, 04 or 05, the jogging behavior occurs if the [FW] signal is turned on first. However, if the [JG] signal is turned off first, the free-running stop occurs.

12.17.4 External Mechanical Brake Control Settings



- How to control an external mechanical brake interlocked to the operation of the inverter.



- Function to control the external brake used in a lifting system, etc. by the inverter. Changing the Brake control enable [AF130], it is able to select between two types of control methods.
 1. Brake control 1: [AF130] = 01 or 02
Releases and checks the brake while outputting the frequency.
 2. Brake control 2: [AF130] = 03
Controls the brake in conjunction with the servo lock control.
- Brake Control 1
 - Available in those instances where the operations vary for lifting and lowering since different operations can be set for forward and reverse rotations.
 - The 037[BRK] brake release signal for the output terminal function and the 037[BOK] answer back from brake signal for the input terminal function are available.
- [AF130] = 01: For the brake control function, the following parameters are valid.

Item	Valid for both forward and reverse
Brake release wait time	[AF131]
Brake wait time for accel.	[AF132]
Brake wait time for stopping	[AF133]
Brake confirmation signal wait time	[AF134]
Brake release frequency setting	[AF135]
Brake release current setting	[AF136]
Braking frequency	[AF137]



- For using the brake control function, we recommend using controls that generate high torque when the control system [AA121] is started such as:
 - 08: Sensorless vector control (IM);
 - 09: Zero-Hz-range sensorless vector control (IM);
 - 10: Vector control with encoder (IM).
- When an error occurs in the brake sequence, the inverter trips [E036], the brake error signal 038[BER] for the output terminal function is output.
- For the brake control, a trip occurs in the following cases.
 - After the Brake release wait time ([AF131],[AF138]), the output current was less than the Brake release current setting ([AF136],[AF143]).
 - When the answer back from brake signal 037[BOK] is used, [BOK] was not turned on within the Brake confirmation signal wait time ([AF134],[AF141]) at start-up.
 - When the answer back from brake signal 037[BOK] is used, [BOK] was not turned off within the Brake confirmation signal wait time at stop.
 - When the answer back from brake signal 037[BOK] is used, the brake release signal 037[BRK] was being output, but [BOK] was turned off.
- [AF130] = 02: For the brake control function (forward/reverse), the following parameters are valid.

Item	Forward rotation side	Reverse rotation side
Brake release wait time	[AF131]	[AF138]
Brake wait time for accel.	[AF132]	[AF139]
Brake wait time for stopping	[AF133]	[AF140]
Brake confirmation signal wait time	[AF134]	[AF141]
Brake release frequency setting	[AF135]	[AF142]
Brake release current setting	[AF136]	[AF143]
Braking frequency	[AF137]	[AF144]

■ Brake Control 1 Function (with the [BOK] Setting).

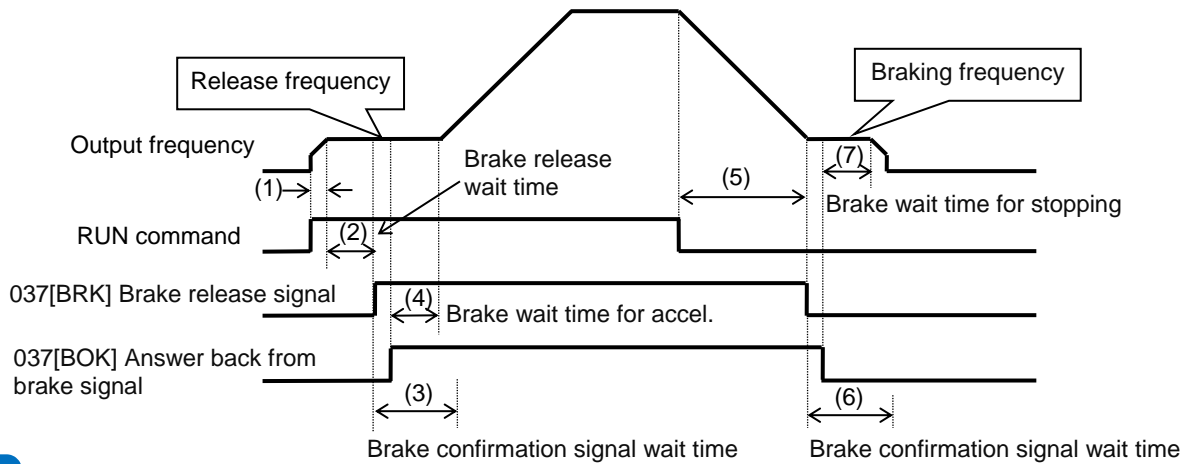

(1) When the RUN command is turned ON, the inverter starts accelerate to the Brake release frequency setting [AF135].

(2) When the Brake release wait time [AF131] passes after the Brake release frequency setting [AF135] is reached, the inverter outputs the brake release signal 037[BRK].



- At this time, if the output current is less than the current set for the release current, the brake release signal is not output and the trip occurs with the [E036] brake error outputting the brake error signal 038[BER].

(3) The operation varies depending on whether the 037[BOK] Answer back from brake signal is set to the input terminal function.

With [BOK] setting	The inverter turns ON the [BRK] brake release signal and waits for the input (ON) of the [BOK] Answer back from brake signal without accelerating during the Brake confirmation signal wait time [AF134]. If the [BOK] is not turned ON during the above time, the inverter trips with the [E036] brake error outputting the fault signal [BER]. When [BOK] ON is detected, go to (4).
Without [BOK] setting	After the [BRK] brake release signal is turned ON, the process goes to the (4) regardless of the Brake confirmation signal wait time [AF134].

(4) After the Brake wait time for accel. [AF132], the inverter starts normal driving.

(5) When the RUN command is turned OFF, the inverter decelerates to the Braking frequency [AF137] and turns OFF the [BRK].

(6) The operation varies depending on whether the 037[BOK] Answer back from brake signal is set to the input terminal function.

With [BOK] setting	The inverter turns OFF the [BRK] brake release signal and waits for the input (OFF) of the [BOK] Answer back from brake signal without decelerating during the Brake confirmation signal wait time [AF134]. If the [BOK] is not turned OFF during the above time, the inverter trips with the [E036] brake error outputting the fault signal [BER]. When [BOK] ON is detected, go to (7).
Without [BOK] setting	After [BRK] brake release signal is turned OFF, the process goes to (7) regardless of the Brake confirmation signal wait time [AF134].

(7) The operation varies depending on whether the 037[BOK] Answer back from brake signal is set to the input terminal function.

With [BOK] setting	When [BOK] ON is detected, the inverter decelerates again to 0 Hz after the Brake wait time for stopping [AF133] passes.
Without [BOK] setting	When the [BRK] brake release signal is turned OFF, the inverter decelerates again to 0 Hz after the Brake wait time for stopping [AF133] passes.



- Set the Brake release frequency setting [AF135] and Braking frequency [AF137] lower than the frequency reference. Otherwise, unintended braking may occur.
- If the RUN command is the forward command, the parameters on the side of the forward rotation are adopted; if it is the reverse command, those on the side of the reverse rotation are adopted.

■ Setting Items Required for the Brake Control 1 Function.

Name		Code	Data range (unit)	Description
Brake control enable, 1st-motor		[AF130]	00	Disabled
			01	Brake control 1: Common *1)
			02	Brake control 1: Separate (forward/reverse set individually)
Brake release wait time, 1st-motor	Forward rotation	[AF131]	0.00 to 5.00(s)	Sets the time after the release frequency is reached until the output current reaches the release current
	Reverse rotation	[AF138]		
Brake wait time for accel., 1st-motor	Forward rotation	[AF132]	0.00 to 5.00(s)	Sets the mechanical delay time after the release signal is sent until the brake is released
	Reverse rotation	[AF139]		
Brake wait time for stopping, 1st-motor	Forward rotation	[AF133]	0.00 to 5.00(s)	Sets the mechanical delay time after the release signal is turned off until the brake is closed
	Reverse rotation	[AF140]		
Brake confirmation signal wait time, 1st-motor	Forward rotation	[AF134]	0.00 to 5.00(s)	Set the time not less than the time after the release signal is sent until the release completion signal output from the brake is input to the inverter.
	Reverse rotation	[AF141]		
Brake release frequency setting, 1st-motor	Forward rotation	[AF135]	0.00 to 590.0(Hz)	Setting the frequency to output the brake release signal *2)
	Reverse rotation	[AF142]		
Brake release current setting, 1st-motor	Forward rotation	[AF136]	Inverter rated current ×(0.0 to 2.0) (A)	Setting the output current to allow the brake release *3)
	Reverse rotation	[AF143]		
Braking frequency, 1st-motor	Forward rotation	[AF137]	0.00 to 590.0(Hz)	Setting the frequency to close the brake at the time of stop *2)
	Reverse rotation	[AF144]		
Input terminal function		[CA-01] to [CA-11]	037	[BOK] Answer back from brake signal. This is the answer back signal of the [BRK] Brake release signal. OFF: Brake applied. ON: Brake released.
Output terminal function		[CC-01] to [CC-07]	037	[BRK] Brake release signal. OFF: Brake apply command. ON: Brake release command.
			038	[BER] Brake error signal OFF: Brake sequence is normal ON: Brake sequence is abnormal

*1) If [AF130] = 01, the forward rotation settings, [AF131] to [AF137] are valid for both the forward and reverse rotations.

*2) Set the time greater than the value of the Minimum frequency [Hb130].

*3) Note that if the set value is small, the brake may be released even though the brake is not applied sufficiently.

■ Brake Control 2.

- The brake control by managing time is available.
- The 037[BRK] Brake release signal for the output terminal function and the 037[BOK] Answer back from brake signal for the input terminal function are available.
- [AF130] = 03: For the brake control function 2, the following parameters are valid.

Item	Valid for both forward and reverse
Brake open delay time, 1st-motor	[AF150]
Brake close delay time, 1st-motor	[AF151]
Brake response check time, 1st-motor	[AF152]
Servo lock/ DC injection time at start, 1st-motor	[AF153]
Servo lock/ DC injection time at stop, 1st-motor	[AF154]

■ Brake Control 2 Function.

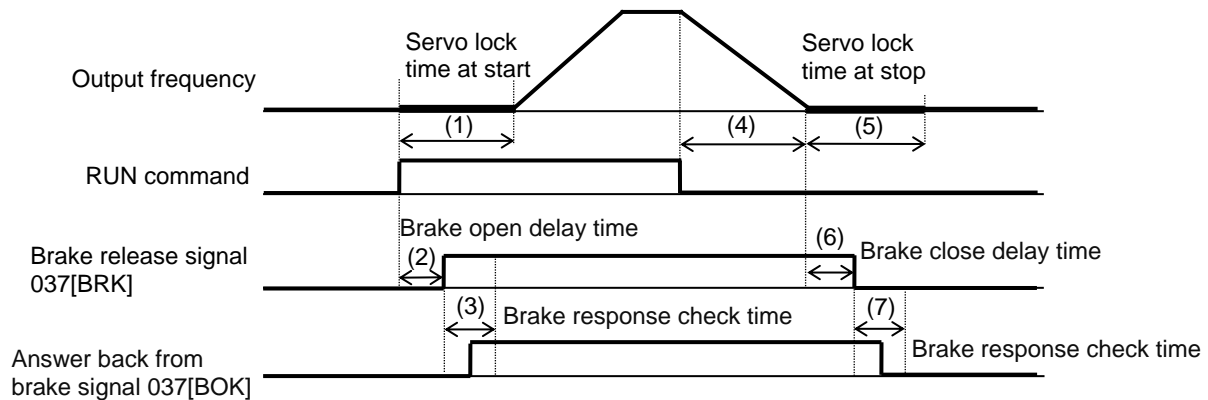

- To perform the servo lock in brake control 2, select 09:Zero Hz range sensorless vector control (IM) or 10:Vector control with encoder (IM) for the [AA121] control mode. In other control modes, the DC braking operation is performed instead of servo lock operation.
- For the brake control 2, an error occurs with a trip in the following cases when the 037[BOK] Answer back from brake signal is used:
 - [BOK] is not turned on within the Brake response check time [AF152] at start-up;
 - [BOK] is not turned off within the the Brake response check time [AF152] at stop;
 - The 037[BRK] Brake release signal is turned ON but [BOK] is turned OFF;



- (1) When the RUN command is turned ON, the servo lock is applied until the servo lock time at start [AF153] (or [AF150]+[AF152] whichever is longer).
- (2) After the Brake open delay time [AF150] passes, the 037[BRK] brake release signal is turned ON.
- (3) The operation varies depending on whether the 037[BOK] Answer back from brake signal is set to the input terminal function.

With [BOK] setting	The inverter waits for the input (ON) of the [BOK] signal until the Brake response check time [AF152]. If the 037[BOK] is not turned ON by the time [AF152] is passed, the inverter trips with the [E036] Brake error and outputs the fault signal 038[BER]. When [BOK] ON is detected, the inverter performs servo lock until (1) time and then starts normal driving.
Without [BOK] setting	The inverter performs servo lock until (1) time, and then starts normal driving.

- (4) When the RUN command is turned OFF, the inverter decelerates and then perform the servo lock.
- (5) The servo lock is kept for the Servo lock time at stop [AF154] (or [AF151]+[AF152] whichever is longer).
- (6) After the Brake close delay time [AF151] passes, the 037[BRK] brake release signal is turned OFF.
- (7) The operation varies depending on whether the 037[BOK] Answer back from brake signal is set to the input terminal function.

With [BOK] setting	The inverter waits for the input (OFF) of the [BOK] signal until the Brake response check time [AF152]. If the 037[BOK] is not turned OFF by the time [AF152] is passed, the inverter trips with the [E036] brake error and outputs the fault signal 038[BER]. When [BOK] OFF is detected, the inverter performs servo lock until (5) time and then stops.
Without [BOK] setting	The inverter performs servo lock until (5) time and then stops.

■ Setting Items Required for the Brake Control 2 Function.

Name	Code	Data range (unit)	Description
Brake control enable, 1st-motor	[AF130]	03	Brake control 2
Brake open delay time, 1st-motor	[AF150]	0.00 to 2.00(s)	Set the brake release delay time.
Brake close delay time, 1st-motor	[AF151]	0.00 to 2.00(s)	Set the brake apply delay time.
Brake response check time, 1st-motor	[AF152]	0.00 to 5.00(s)	Set the time to check the brake.
Servo lock/ DC injection time at start, 1st-motor	[AF153]	0.00 to 10.00(s)	Set the servo lock time at start.
Servo lock/ DC injection time at stop, 1st-motor	[AF154]	0.00 to 10.00(s)	Set the servo lock time at stop.
DC braking force setting, 1st-motor	[AF105]	0 to 100(%) (Might be internally limited)	If the control method is neither 09: Zero-Hz-range sensorless vector control (IM) nor 10: Vector control with encoder (IM), the DC braking is applied. Set the braking force (at the time of stop).
DC braking force at start, 1st-motor	[AF108]	0 to 100(%) (Might be internally limited)	If the control method is neither 09: Zero-Hz-range sensorless vector control (IM) nor 10: Vector control with encoder (IM), the DC braking is applied. Set the braking force (at the time of start).

12.17.5 External Contactor Control Settings



- How to perform the operation sequence using a contactor.
- How to involve a contactor on the output side for the control.
- How to save energy by controlling the contactor on the input side.



- For performing the contactor operation, set the [AF120] Contactor control enable to 01.
- The 039[CON] contactor control signal for the output terminal function and the 107[COK] contactor check signal for the input terminal function are available.



- The contactor control requires this function because operating a contactor during the inverter output generates a surge causing damage to the inverter.
- When an error occurs in the contactor sequence, the inverter trips at [E110].

- For the contactor control, in the case at which the contactor check signal 107[COK] is used, a trip occurs at the following:
 - [COK] is not turned on within the Contactor response check time [AF123] at start-up;
 - [COK] is not turned off within Contactor response check time [AF123] at stop;
 - [COK] is turned off while the contactor control signal 039[CON] is on;

■ Setting Items Required for the Contactor Control Function.

Name	Code	Data range (unit)	Description
Contactor control enable, 1st-motor	[AF120]	00	Disabled.
		01	Enabled (primary side). Place a contactor on the input side of the inverter to reduce standby power.
		02	Enabled (secondary side). Place a contactor on the output side of the inverter to implement the function as a brake sequence.
Run delay time, 1st-motor	[AF121]	0.00 to 2.00(s)	Set the waiting time from the input of a RUN command to the start of the inverter output.
Contactor off delay time, 1st-motor	[AF122]	0.00 to 2.00(s)	Set the time from the output shutoff of the inverter to the control of the contactor.
Contactor response check time, 1st-motor	[AF123]	0.00 to 5.00(s)	Set the time from the input a RUN command to the control of the contactor.
Input terminal function	[CA-01] to [CA-11]	107	[COK] Contactor check signal. OFF: Contactor released. ON: Contactor in operation.
Output terminal function	[CC-01] to [CC-07]	039	[CON] Contactor control signal. OFF: Contactor release command. ON: Contactor operation command.

■ Example of Energy Saving on the input side contactor.

(AF120 = 01: Enabled (Primary Side))

- Reduce standby power in combination with the external 24 VDC power supply for control circuit. For details of the external 24 VDC power supply P+/P-, refer to the description table of P+/P- in "7.7.4 Upper Portion Wiring of the Control Circuit".
- Connecting the auxiliary contact MC for the main circuit power supply to the setting terminal of the output terminal function [CON] shuts off the power input to the inverter main circuit while the inverter output is suspended to implement the operation sequence for energy saving.

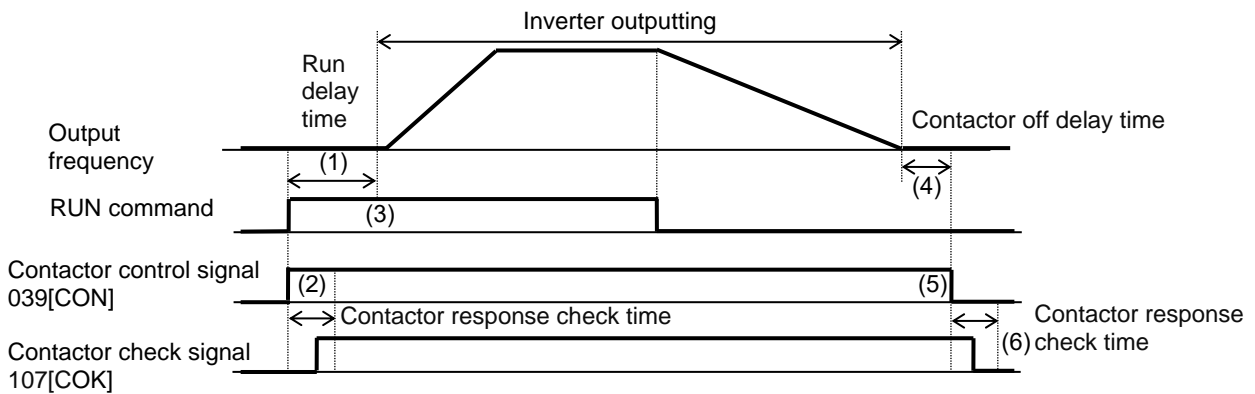
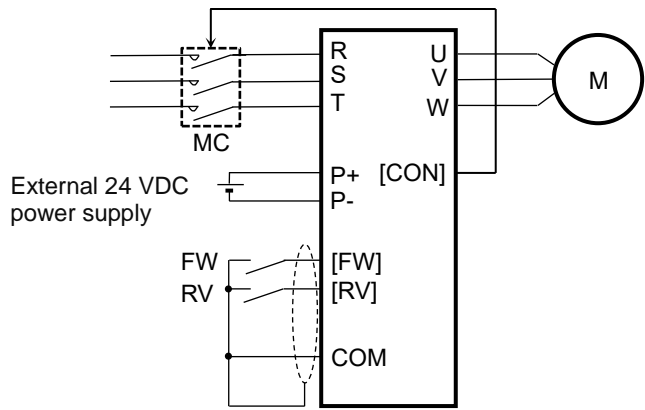

- (1) When the RUN command is turned ON, the inverter waits for the start of driving until the Run delay time [AF121] passes.
- (2) The 039 [CON] contactor control signal is turned ON when the same time as the RUN command is turned ON. The operation varies depending on whether the 107[COK] Contactor check signal is set to the input terminal function.

With [COK] setting	If the 107[COK] is not turned ON by the Contactor response check time [AF123] passes, the inverter trips with the [E110] contactor error.
Without [COK] setting	Wait for the Run delay time [AF121] to pass.

- (3) After the Run delay time [AF121] passes, the inverter starts normal driving.

- (4) When the RUN command is turned OFF, the inverter decelerates and stops, and then waits until the Contactor off delay time [AF122] passes.
- (5) After the Contactor off delay time [AF122] is passed, the 039[CON] contactor control signal is turned OFF.
- (6) The operation varies depending on whether the contactor check signal 107[COK] is set to the input terminal function.

With [COK] setting	If the 107[COK] is not turned OFF by the Contactor response check time [AF123] passes, the inverter trips with the [E110] contactor error.
Without [COK] setting	The inverter is in stopping.

■ Example of the Control on the output side
contactor.

(AF120 = 02: Enabled (secondary side))

- When Enabled (secondary side) is selected, using in combination with the brake control 2 is available.

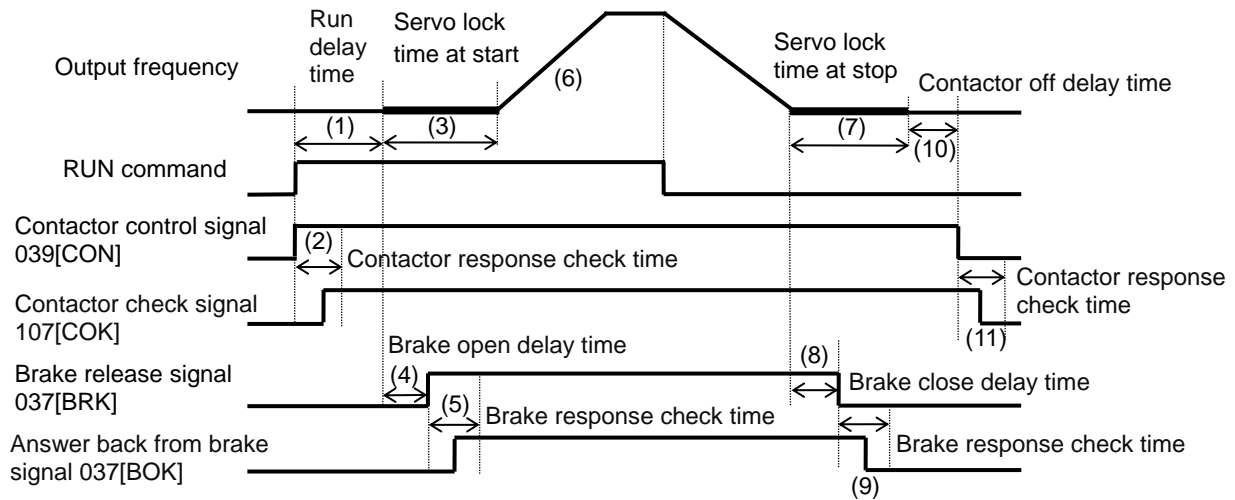

(1) When the RUN command is turned ON, the 039[CON] Contactor control signal is turned ON at the same time.

(2) The operation varies depending on whether the 107[COK] Contactor check signal is set to the input terminal function.

With [COK] setting	If the 107[COK] is not turned ON by the Contactor response check time [AF123] passes, the inverter trips with the [E110] contactor error.
Without [COK] setting	Wait for the Run delay time [AF121] to pass.

(3) The inverter performs servo lock operation until the Servo lock time at start [AF153].

(4) After the Brake open delay time [AF150] passes, the 037[BRK] Brake release signal is turned on.

(5) The operation varies depending on whether the 037[BOK] Answer back from brake signal is set to the input terminal function.

With [BOK] setting	If the 037[BOK] is not turned ON by the time of the Brake response check time [AF152] is passed, the inverter trips with the [E036] Brake error and outputs the fault signal 038[BER]. When [BOK] ON is detected, go to (6).
Without [BOK] setting	Wait for the the Servo lock time at start [AF153] to pass, and then go to (6).

(6) After the [AF153] passes, the inverter starts normal driving.

(7) When the RUN command is turned OFF, the inverter decelerates, and then servo-lock is performed until the Servo lock time at stop [AF154].

(8) After the Brake close delay time [AF151] passes, the 037[BRK] brake release signal is turned OFF.

(9) The operation varies depending on whether the 037[BOK] Answer back from brake signal is set to the input terminal function.

With [BOK] setting	If the 037[BOK] is not turned ON by the time of the Brake response check time [AF152] is passed, the inverter trips with the [E036] Brake error and outputs the fault signal 038[BER]. When [BOK] ON is detected, go to (10).
Without [BOK] setting	Wait for the the Servo lock time at stop [AF154] to pass, and then go to (10).

(10) The inverter shuts off the output, and after the Contactor off delay time [AF122] is passed, the 039[CON] Contactor control signal is turned OFF.

(11) The operation varies depending on whether the 107[COK] Contactor check signal is set to the input terminal function.

With [COK] setting	If the 107[COK] is not turned OFF by the Contactor response check time [AF123] passes, the inverter trips with the [E110] contactor error.
Without [COK] setting	The inverter is in stopping.

12.17.6 Emergency Forced Driving Settings

Q

- How to switch to the forced operation mode with the signal input.
- How to keep driving until the power supply is cut off.
- How to enter the operation mode using a commercial power supply when the inverter cannot be restarted due to a failure.

A

- Performing this function enables the inverter to run in the forced operation mode (Em-Force mode) in which it operates at a constant speed without shutting off the inverter output until the power-off.
- Set the Enable Emergency-force drive mode [PA-01] to 01 (enabled) and turn on the 105 [EMF] Emergency-Force Drive activation input terminal function to enter the forced operation mode.
- The command for the forced operation mode is set with the Emergency-force drive frequency reference [PA-02] and the Emergency-force drive direction command [PA-03].

!

- Once the forced operation mode is turned on, the inverter keeps operating until the power is off.
- When using the forced operation mode, make sure that the system is safe even if operation is continued.
- Overcurrent retry, overvoltage retry, undervoltage retry or instantaneous power failure retry automatically operates. A separate setting is required to change the operation details.
- After the Emergency-Force Drive activation 105 [EMF] is turned on, the input terminal function except for the following are disabled.
⇒[COK]: Contactor check signal

Parameter Setting.

Name	Code	Data range (unit)	Description
Enable Emergency-force drive mode	[PA-01]	00	Disabled
		01	Enabled
Emergency-force drive frequency reference	[PA-02]	0.00 to 590.00(Hz)	Set the frequency command in the forced operation mode.
Emergency-force drive direction command	[PA-03]	00	Forward rotation command
		01	Reverse rotation command

Input Terminal Setting.

Name	Code	Data range (unit)	Description
Input terminal function	[CA-01] to [CA-11]	105	[EMF] :Emergency-Force Drive activation OFF: Disabled ON: Forced operation mode (when [PA-01] = 01)

Output Terminal Setting.

Name	Code	Data range (unit)	Description
output terminal function	[CC-01] to [CC-07]	076	[EMFC] : Emergency force drive indicator OFF: Disabled ON: In the forced operation mode

Behavior in the Forced Operation.



- The 105 [EMF] Emergency-Force Drive activation input terminal function is turned on, the forced operation mode operates.
- The inverter performs the output at the frequency set to the Emergency-force drive frequency reference [PA-02] and rotation direction set to the rotation direction command in the Emergency -force drive direction command [PA-03].

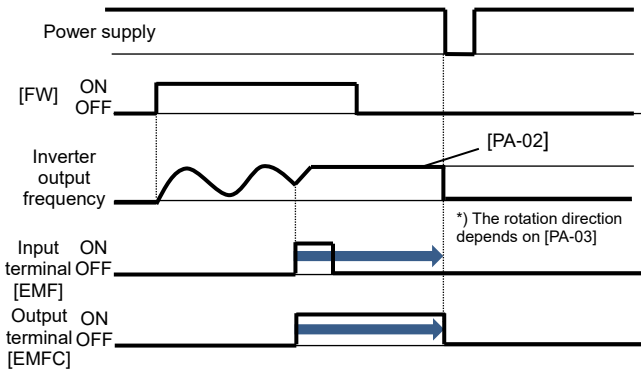

- In the forced operation mode, the following functions are operating automatically.
 - (1) Soft lock status (equivalent to [UA-16] = 01) The parameters can be no longer changed. To restore the settings, turn off [EMF], restore the power and then change the parameters.
 - (2) Auto-reset (equivalent to [bb-10] = 02) When a trip that can be released occurs, the reset is performed automatically to restart.
 - (3) STOP key disabled (equivalent to [AA-13] = 00) Disable the STOP/RESET keys on the operator keypad.
 - (4) Operation enabled during the optional start ([oA-13] = 01, [oA-23] = 01, [oA-33] = 01) The operation is allowed even in the optional start-up.
- The functions except for the above operate according to the settings.

Auto-Reset Behavior in the Forced Operation.



- When an error occurs during the forced operation and the inverter trips, the reset equivalent to the one at power-on is performed.

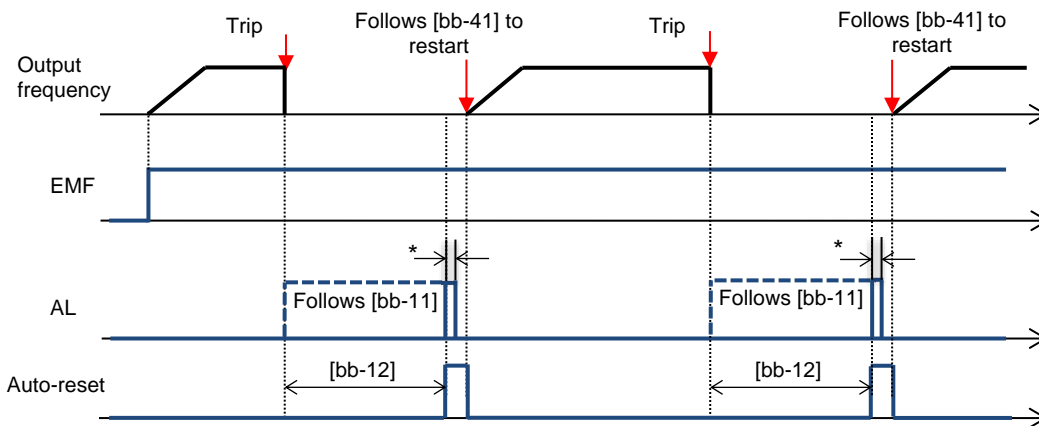

*For the AL relay terminal, due to the MCU reset (equivalent to Power ON reset), on for a moment no matter what is assigned.

Auto-Reset at the Forced Behavior.

(The following parameters themselves are not changed.)

Name	Code	At the Forced Behavior	Description
Auto-reset selection	-	All errors reset in addition to [bb-10]=02	[bb-10]=02 is applied to all errors regardless setting (02: valid executed after the time defined by [bb-12])
Alarm signal selection at automatic error reset	[bb-11]	Follows the setting for [bb-11]	Parameter setting is enabled. However, due to the system reset, AL is turned on for a moment even if AL is set for the output.
Automatic error reset wait time	[bb-12]	Follows the setting for [bb-12]	Parameter setting is enabled.
Automatic error reset number	[bb-13]	Change to no limit	Forcibly reset an infinite number of times regardless the settings.
Restart mode after RS release	[bb-41]	Follows the setting for [bb-41]	Parameter setting is enabled. For other retry settings ([bb-20] to [bb-31]), the parameter settings are enabled.

■ Switching to the Commercial Operation (Bypass Mode).

A

- When the Bypass function selection [PA-04] is set to 01(Enabled), switching to the commercial operation mode (bypass mode) is allowed if the specified operation mode is not entered during the forced operation.
- In the bypass mode, output terminal 077 [EMBP] bypass mode signal is turned on and the inverter output is shut off.
- For the behavior in the bypass mode, refer to the following sample connection diagram for the commercial switching operation and timing.
- Perform the contactor control based on the output terminal 077 [EMBP] bypass mode signal.

!

- For using the bypass mode, it is necessary to implement an interlock taking into consideration the operation delay of the contactor when shifting to the commercial operation. Make sure that the system operation is safe in using the mode.
- The timing of the contactor control can be taken using the output terminal 077 [EMBP] bypass mode signal as the contactor control signal. Take an interlock between the contactor on the commercial power supply side and that on the inverter output side.
- When the earth leakage breaker ELCB trips, the commercial circuit will not operate, so if a backup is required, connect a different commercial circuit to MC2.

Sample connection diagram when shifting to the commercial operation and timing

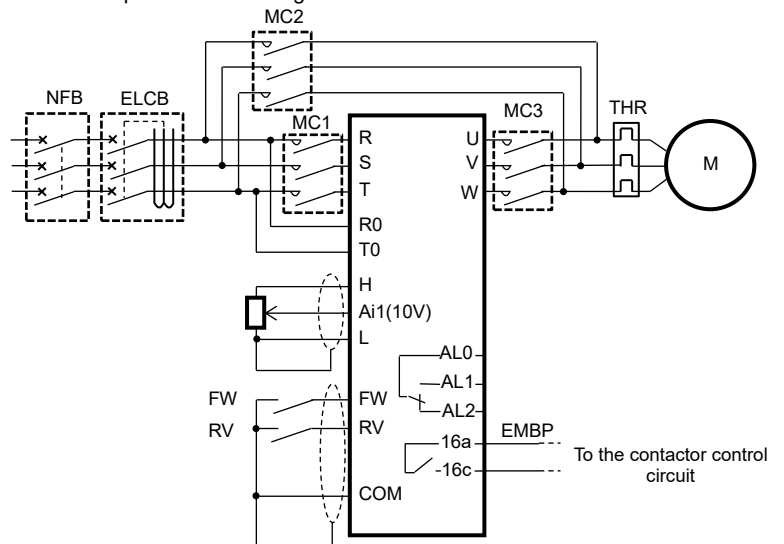

Example of timing from INV to the commercial operation.

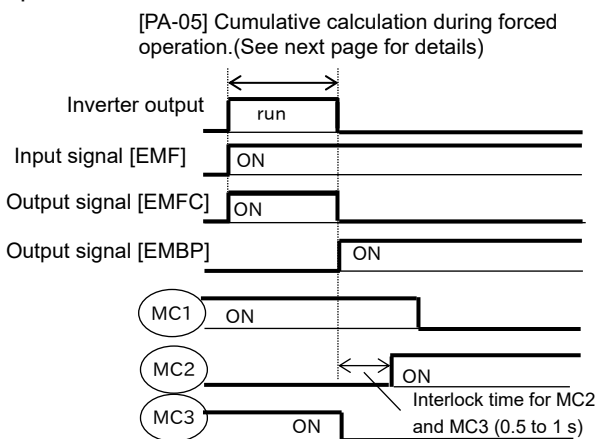

■ Parameter Setting.

Name	Code	Data range (unit)	Description
Commercial power supply bypass function selection	[PA-04]	00	Disabled.
		01	Enabled.
Commercial power supply bypass function delay time	[PA-05]	0.0 to 1000.0(s)	Set the delay time until the bypass mode operation.

■ Output Terminal Setting.

Name	Code	Data range (unit)	Description
output terminal function	[CC-01] to [CC-07]	077	[EMBP] :Bypass mode indicator. OFF: Disabled. ON: In the bypass mode.

■ Decision for Switching to the Bypass Mode.

A

- When the Commercial power supply bypass function selection [PA-04] is set to 01 (enabled) and during forced operation, If the period that the output frequency cannot reach the [PA-02] is longer than the [PA-05] and the inverter is not ready for operation (output terminal [IRDY] is OFF), the inverter operates in commercial operation mode (bypass mode).



- Once the bypass mode is turned on, the inverter keeps shutting off until the power is off.
- While the inverter is operating immediately after the reset, the output terminal [IRDY] is turned off for about a second, however, the bypass mode is not entered for that period.
- When frequency doesn't reach to Em-Force mode frequency setting [PA-02] while upper limiter function is activated, accumulation of delay time is added.

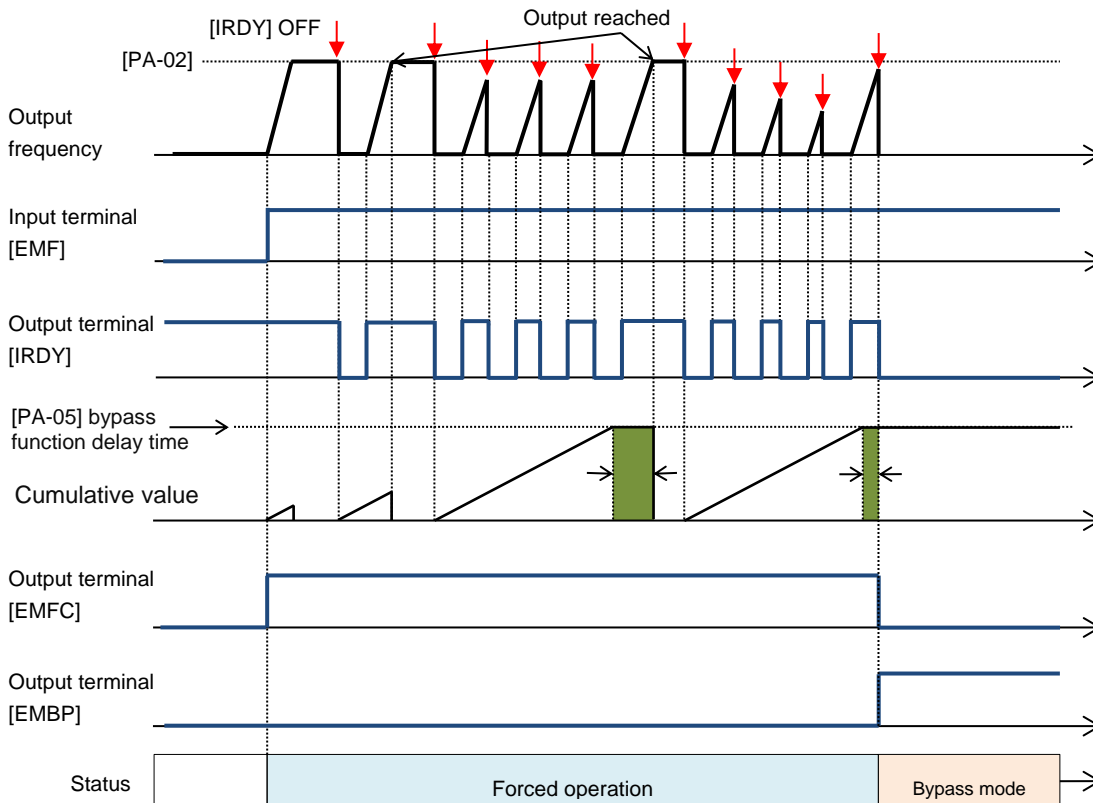

- In the bypass mode, the following functions are operating automatically.

- Soft lock status (equivalent to [UA-16] = 01). The parameters can be no longer changed. To restore the settings, turn off [EMF], restore the power and then change the parameters.
- Auto-reset (equivalent to [bb-10] = 00). Auto-reset is disabled.

- STOP key disabled (equivalent to [AA-13] = 00). Disable the STOP/RESET keys on the operator keypad.
- Operation enabled during the optional start ([oA-13] = 01, [oA-23] = 01, [oA-33] = 01). The operation is allowed even in the optional start-up.

- The functions except for the above operate according to the settings.

12.17.7 Pulse Train Position Control Settings



- How to input the pulse train to the feedback option to perform the position control.



- Pulse train position control is possible by inputting the pulse train to the SAP-SAN and SBP-SBN terminals of the feedback option (P1-FB).
- In the position control mode, the acceleration/deceleration time is disabled. (The inverter output is performed following the speed command. (refer to the following right.)) The larger the position loop back gain is, the shorter the acceleration/deceleration time becomes.
- Start the input of the pulse train by assigning the 073[STAT] Pulse train position reference input enable to the input terminal and turning on the terminal.



- Using this function requires the following settings:
 - Set 10:Vector control with encoder (IM) to the Control mode selection [AA121];
 - Set 01:Pulse train position control to the Vector control mode selection [AA123];
 - Set 01:Pulse train position reference to the Pulse train input, target function selection (option) [ob-10];

- The speed command in the pulse train position control mode is calculated by the following formula.

$$\text{Speed command (Hz)} = \frac{P}{2} \times K_v \times \frac{\Delta P}{4 \times \text{ENC}}$$

P: Number of motor poles
 Kv: Position loop gain
 ENC: Number of encoder pulses
 ΔP : Position deviation

- See also "12.9.17 Use Encoder".

Setting Items for the Pulse Train Position Control.

Name	Code	Data range (unit)	Description
Control mode selection, 1st-motor	[AA121]	10	Vector control with encoder (IM)
Vector control mode selection, 1st-motor	[AA123]	01	Pulse train position control
Pulse train input, target function selection (option)	[ob-10]	00	Pulse train frequency reference
		01	Pulse train position reference
Pulse train input mode selection (option)	[ob-11]	00	MD0: 90°shift pulse train
		01	MD1: Forward/ Reverse pulse train and direction signal
		02	MD2: Forward pulse train and Reverse pulse train
Electronic gear setting point selection	[AE-01]	00	FB: Feedback side
		01	REF: Reference side
Electronic gear ratio numerator	[AE-02]	1 to 10000	Numerator of th electronic gear
Electronic gear ratio denominator	[AE-03]	1 to 10000	Denominator of th electronic gear
Positioning completion range setting	[AE-04]	0 to 10000 (pls)	Set the value equivalent to encoder 4 multiplication
Positioning completion delay time setting	[AE-05]	0.00 to 10.00 (s)	Set the time from the positioning completion to the output of the [POK] signal.
Position feedforward gain setting	[AE-06]	0.00 to 655.35	Position feed forward gain.
Position loop gain setting	[AE-07]	0.00 to 100.00	Position loop gain.
Position bias setting	[AE-08]	-2048 to 2048 (pls)	Set the bias value of the position.

■ Setting Items for the Pulse Train Position Control.

Name	Code	Data range (unit)	Description
Add frequency setting, 1st-motor	[AA106]	-590.00 to 590.00(Hz)	Frequency added when the [ADD] terminal is turned on.
Position deviation error mode selection	[bb-85]	00	The excessive position deviation signal [PDD] is output.
		01	The output of the excessive position deviation signal [PDD] and the position deviation error [E106] cause a trip.
Position deviation error detection level	[bb-86]	0 to 65535($\times 100$ pls)	The level for deciding an abnormal position deviation.
Position deviation error detection time	[bb-87]	0.0 to 5.0(s)	Set the time after an abnormal status occurs until the output of [PDD] and error.
Input terminal function	[CA-01] to [CA-11]	014	ADD: Trigger for frequency addition
		072	PCLR: Clearance of position deviation
		073	STAT: Pulse train position reference input enable
		074	PUP: Position bias (ADD)
		075	PDN: Position bias (SUB)
Output terminal function	[CC-01] to [CC-07]	042	PDD: Position over deviation
Current position monitor	[dA-20]	When [AA121] \neq 10 or, [AA123] \neq 03 -536870912 to 536870911(pls)/ When other than above -2147483648 to 2147483647(pls)	Displays the current position during pulse train position control and absolute position control.
Pulse train position deviation monitor	[dA-26]	-2147483647 to 2147483647 (pls)	Displays the position deviation for the position reference and position feedback.

■ Input Mode for the Pulse Train Position Control

- For more information about the pulse train input mode, refer to the following.

1. MD0: 90° shift pulse train.

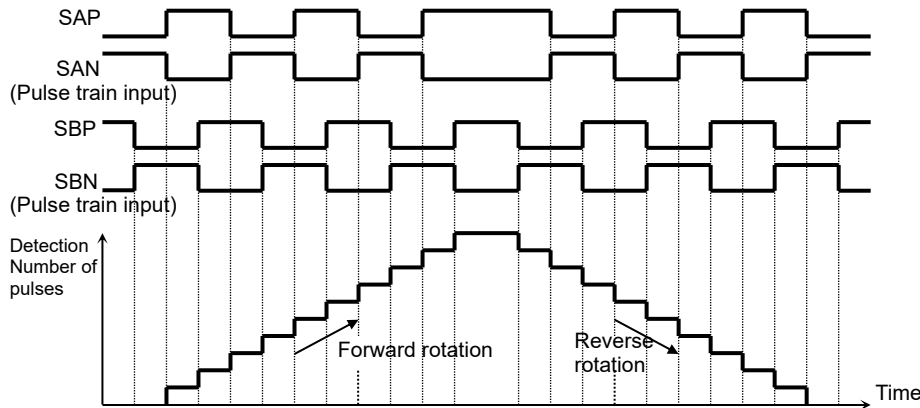

2. MD1: Forward/ Reverse pulse train and direction signal.

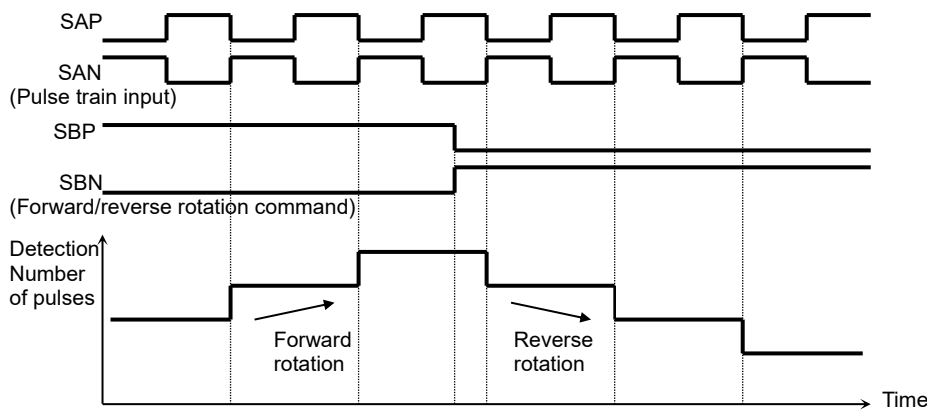

3. MD2: Forward pulse train and Reverse pulse train.

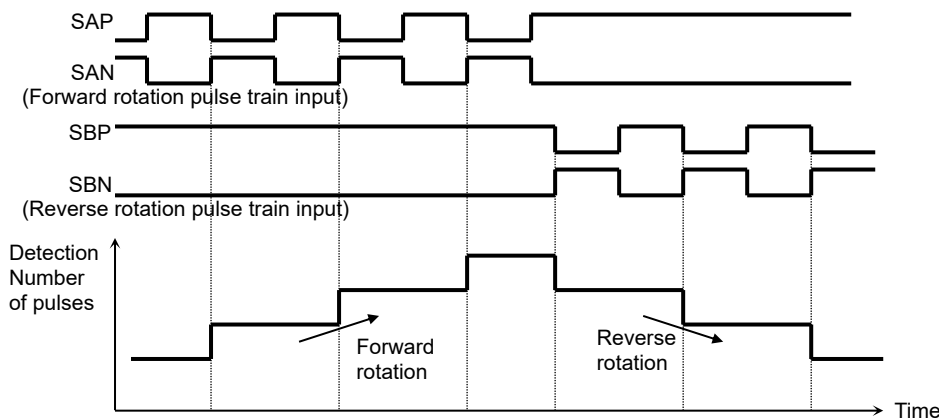

Electronic Gear Function.

A

- This function enables you to set the gain for the position command or position feedback to change the rotation ratio of the main and sub motors when performs the synchronous operation.

[AE-01] = 00 (feedback side)

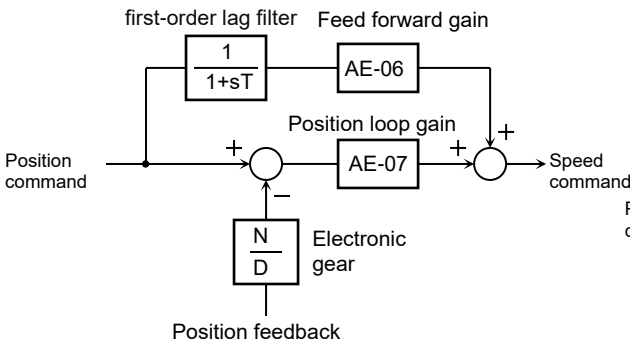

!

- Make sure that the setting of N/D is in the range of $1/50 \leq N/D \leq 20$.
 N: [AE-02] Electronic gear ratio numerator
 D: [AE-03] Electronic gear ratio denominator

[AE-01] = 01 (command side)

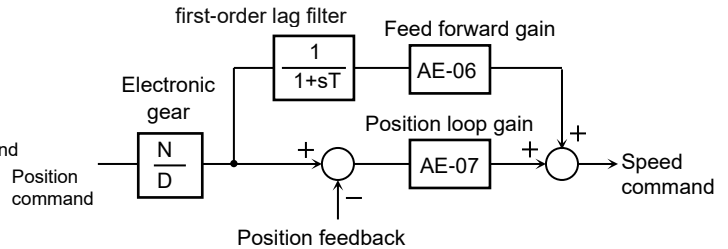

Example of Synchronous Operation between Master and Slave.

- When performing master-slave synchronous operation, use encoder feedback option P1-FB.
- The master unit is operable with any control methods ([AA121]).
- The slave unit performs the pulse train position control with vector control.
 ([AA121]=10,[AA123]=01,[ob-10]=01)
 • Assign the 073[STAT] Pulse train position reference input enable to an input terminal and turn on the terminal.
 When the 073[STAT] is off, the pulse train input is not accepted.

<Setting Examples>

- Main motor: Number of encoder pulses is 1024
- Sub motor: Number of encoder pulses is 3000
- Main motor rotation speed : sub motor rotation speed = 2 : 1
 For the operation with the above conditions, set the following data to the slave unit.
 [ob-11]Pulse train input mode selection (option): 00
 [AE-01]Electronic gear setting point selection: 01 (REF)
 [AE-02]Electronic gear ratio numerator: 3000
 [AE-03]Electronic gear ratio denominator: $1024 \times 2 = 2048$

- The encoder output [AP][BP][AN][BN] of the main motor is retrieved as the pulse train position reference [SAP][SBP][SAN][SBN] of the slave unit.
- When the main motor speed is high, the change amount of the pulse per unit time is getting large and the speed command of the slave unit is also getting large. When the main motor speed is low, the speed command of the slave unit is also getting small.
- This causes the sub motor follows the main motor to operate.

!

- If the follow-up response on the slave side is slow, adjust by raising the [AE-06] feed forward gain or [AE-07] position loop gain.

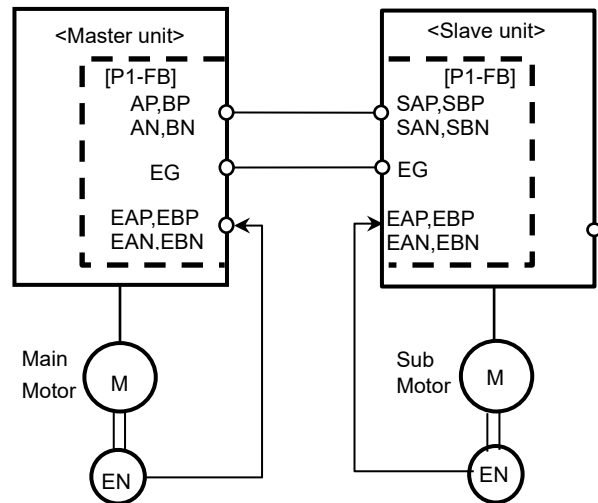

Position Bias Function.

A

- Used to apply a bias to the position reference for the pulse train position control.
 - Add/subtract the set number of pulses to the change amount every 1 ms. Used to adjust the phase of the synchronization point during the synchronous operation, etc.
 - Set the bias amount to the [AE-08] Position bias setting.
 - Assign either 074(PUP) or 075(PDN) of the input terminal function.
- The bias amount is added while the PUP terminal is on and is subtracted while the PDN terminal is on.

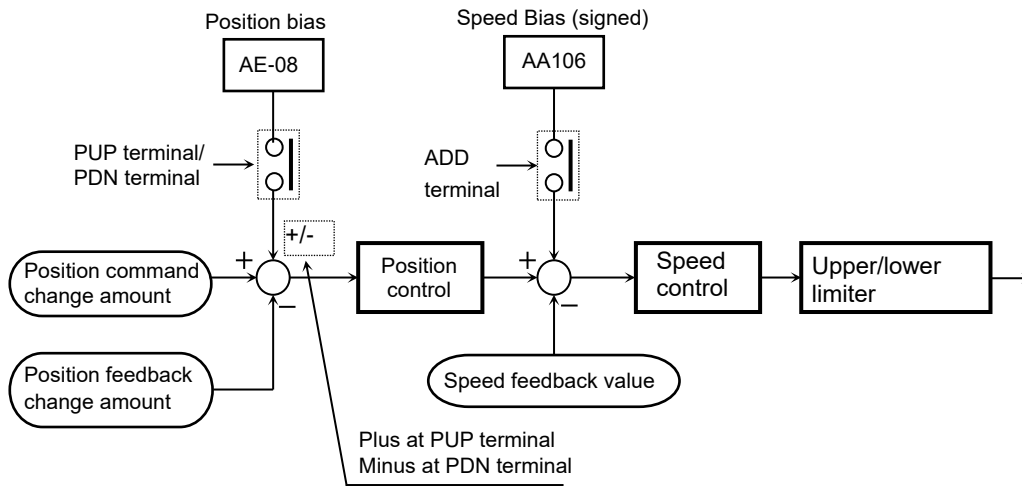

Speed Bias Function.

A

- The function to apply a speed command bias when the pulse train position control is performed.
- Set the bias amount to the [AA106] adding frequency setting.
- Assign 014(ADD) to any of the input terminal function. The bias amount is added/subtracted to the speed command while the ADD terminal is on.

Detecting excessive position deviation.

A

- If the deviation of the position feedback (current position monitor [dA-20]) with respect to the position reference exceeds the position deviation error detection level [bb-86] and the position deviation error detection time [bb-87] passes, it is judged as abnormal.
- The position deviation can be checked with the pulse train position deviation monitor [dA-26].
- When the behavior of the position deviation error mode selection [bb-85] is 00, the output terminal [PDD] is turned on.
- When the [bb-85] is 01, the output terminal [PDD] is turned on and the [E106] position deviation error occurs.
- The position deviation is cleared with on/off of the input terminal 072[PCLR] clearance of position deviation or the trip reset.

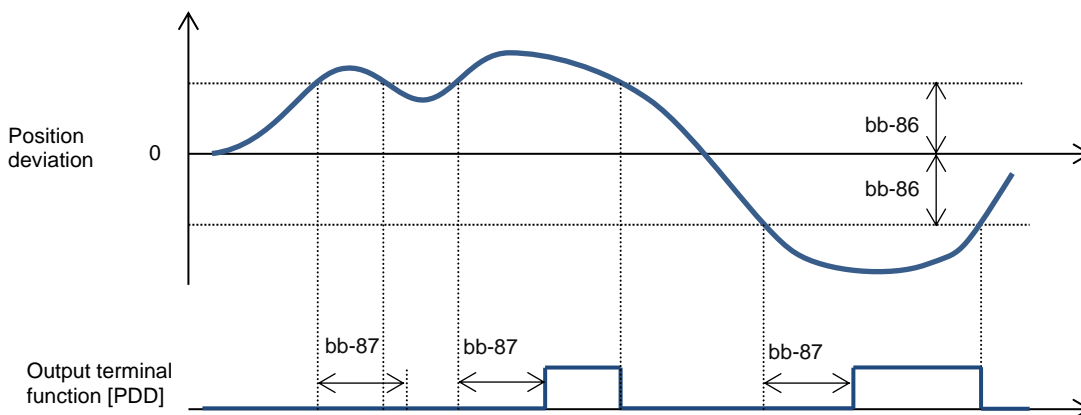

12.17.8 Stopping at the Defined Positions

Q

- How to stop the system at the designated position for the maintenance of a machine tool.
- How to use the orientation function.

A

- The orientation control is available for the pulse train position control.
- Used with the Control mode selection [AA121] set to 10:Vector control with encoder (IM) and the Vector control mode selection [AA123] set to 00: Speed/Torque control mode or 01:Pulse train position control mode.
- This function is used for positioning at any one point during one motor rotation. It can be used to such as change tools on the spindle of machine tools.



- For using this function, it is required to set the Control mode selection [AA121] to 10:vector control with encoder (IM) and use the encoder feedback.
 - See also "12.9.17 Use Encoder".
 - The Z pulse (one rotation position signal) is used as the reference signal for the positioning.
- (1) When the encoder is connected to the P1-FB option:
Input the Z pulse to EZP-EZN terminals.
 - (2) When the encoder is connected to the control circuit terminal block:
Assign the input terminal function 109 [PLZ] to any of the input terminal and input the Z pulse.

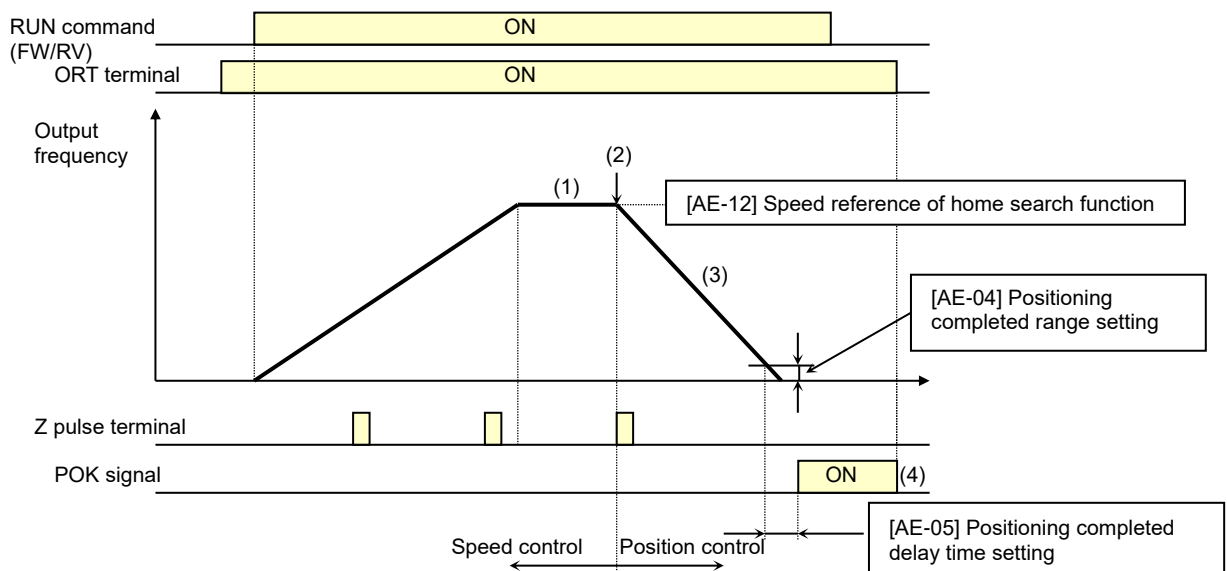

- (1) If the RUN command is turned on while the [ORT] terminal is on, it will accelerate to the Speed reference of home search function [AE-12]. (During the operation, the speed is shifted to the orientation speed as soon as the [ORT] terminal is turned on.)
- (2) After the orientation speed is reached, there is a shift to the position control when the first Z pulse is detected.
- (3) For forward rotation, the Stop position of home search function [AE-11] + 1 rotation is used as the target value for position control. For reverse rotation, the Stop position of home search function [AE-11] + 2 rotations is used as a target value for position control. The larger the Position loop gain setting [AE-07], the shorter the deceleration time. (The deceleration time setting is not followed.)
- (4) The [POK] signal is output after the Positioning completed delay time setting [AE-05] is passed since the remaining number of pulses entered the Positioning completed range setting [AE-04]. (The output continues until the [ORT] terminal is turned off.) After the positioning completes, the servo lock status continues until the RUN command is turned off.

■Parameters.

Name	Code	Data range (unit)	Description
Control mode selection, 1st-motor	[AA121]	10	Vector control with encoder (IM)
Vector control mode selection, 1st-motor	[AA123]	00	Speed/Torque control mode
		01	Pulse train position control mode
Pulse train input, target function selection (Internal)	[CA-90]	00	Disable
		01	Pulse train frequency command
		02	Speed feedback
		03	Pulse count
Pulse train input mode selection (Internal)	[CA-91]	00	90 degrees shift pulse train
		01	Forward/Reverse pulse train and direction signal
		02	Forward pulse train and reverse pulse train
Encoder constant setting (Internal)	[CA-81]	32 to 65535(pls)	Setting of the number of pulses.
Encoder phase sequence selection (Internal)	[CA-82]	00	Phase-A Lead
		01	Phase-B Lead
Encoder constant setting(option)	[ob-01]	32 to 65535(pls)	Setting of the number of pulses.
Encoder phase sequence selection (option)	[ob-02]	00	Phase-A Lead
		01	Phase-B Lead
Stop position selection of home search function	[AE-10]	00	Parameter setting
		01	Option 1
		02	Option 2
		03	Option 3
Stop position of home search function	[AE-11]	0 to 4095	Note 2)
Speed reference of home search function	[AE-12]	0.00 to 120.00(Hz)	Note 1)
Direction of home search function	[AE-13]	00	Forward rotation side
		01	Reverse rotation side
Positioning completed range setting	[AE-04]	0 to 10000(pls)	Set the value equivalent to encoder 4 multiplication
Positioning completed delay time setting	[AE-05]	0.00 to 10.00(s)	Set the time from the positioning completion to the output of the [POK] signal.
Position feedforward gain setting	[AE-06]	0 to 655.35	Position feed forward gain.
Position loop gain setting	[AE-07]	0.00 to 100.00	Position loop gain.
Input terminal function	[CA-01] to [CA-11]	069	ORT: Home search function
		109	PLZ: Pulse train input Z
Output terminal function	[CC-01] to [CA-07]	043	POK: Positioning completed



Note 1: Do not set the orientation speed to a high frequency because the deceleration behavior becomes the positioning status within two rotations. The overvoltage protection may cause a trip.

Note2: Set the orientation stop position by dividing one rotation to 4095 (0 to 4095) in the forward rotation direction starting the reference point (It is fixed at 4096 divisions regardless of the number of encoder pulses). The reference point is where the pulse is input to EZP-EZN terminals, and the stop target position view from the motor shaft load side is as shown in the figure on the right. (For a positive phase connection.)

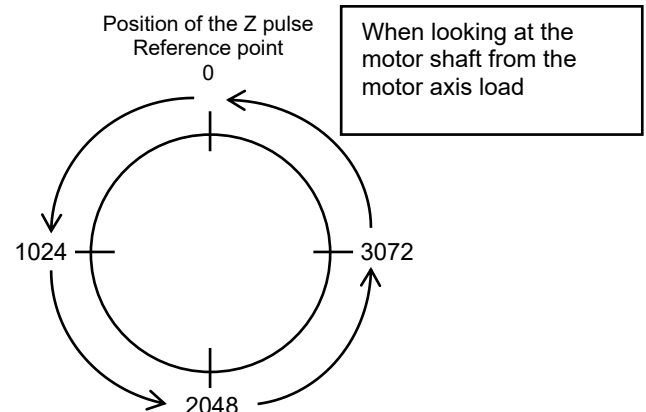

■ Adjustment of Positioning Control.

Adjusting the stop position at the positioning operation.

Occurrence	Workaround Examples
Stop position is long. Position overruns.	<ul style="list-style-type: none"> Adjust by increasing [AE-64] by 5%. or Adjust by increasing [AE-65] by 5%.
Stop position is short. Position shortens.	<ul style="list-style-type: none"> Adjust by decreasing [AE-64] by 5%. or Adjust by decreasing [AE-65] by 5%.

■ Parameters.

Name	Code	Data range (unit)	Description
Deceleration stop distance calculation gain	[AE-64]	50.00 to 200.00 (%)	Adjust against the stop distance.
Deceleration stop distance calculation bias	[AE-65]	0.00 to 655.35 (%)	Adjust the output frequency for the positioning operation.

Adjusting the control gain at the positioning operation.



- Set [AE-66] and [AE-67] to the ratios against the [Hb105] maximum frequency.
- Once the positioning operation is entered, the control starts at the speed set to the [AE-67] APR start speed. (*Note 1)
- During the positioning operation, the speed is limited to that set to the [AE-66] APR control speed limit. During the positioning, the acceleration/deceleration time is 0 and the output follows the internal position control results.
((*Note 1) APR(Automatic Position Regulator))

- For the positioning operation, specify the stop behavior with the following functions:
 - Absolute value control;
 - Homing function;
 - Orientation;
 - SON terminal operation (at position servo);
 - DC braking (at position servo lock control);

Occurrence	Workaround Examples
The follow-up for the positioning stop is bad.	<ul style="list-style-type: none"> Adjust by increasing [AE-07] by 0.1. or Adjust by increasing [AE-67] and [AE-66] by 1%.
An abrupt behavior occurs at the positioning stop.	<ul style="list-style-type: none"> Adjust by decreasing [AE-07] by 0.1. or Adjust by decreasing [AE-67] and [AE-66] by 1%.
An axis vibrates during the stop.	<ul style="list-style-type: none"> Adjust by decreasing [AE-07] by 5.

■ Parameters.

Name	Code	Data range (unit)	Description
Position loop gain setting	[AE-07]	0.00 to 100.00	Adjust the position loop gain.
Speed limit in APR control	[AE-66]	0.00 to 100.00(%)	Limit the output at the positioning.
APR start speed	[AE-67]	0.00 to 100.00(%)	Set the speed at the positioning start.

12.17.9 Absolute Position Control Settings

Q

- How to perform the absolute position control of the origin reference such as a servo drive.

A

- In absolute position control, the inverter operates to the target position according to the following settings. When reached, the position servo lock state is maintained. (The servo lock state is maintained until the RUN command is turned OFF.)
 - (1) Position reference
 - (2) Speed command (frequency reference)
 - (3) Acceleration time and deceleration time
- For the frequency reference and accel./decal. command at the absolute position control, those selected at that time are followed.
- When the position reference is small, there may be the deceleration and then positioning without reaching the speed command value.
- The direction of the RUN command ([FW]/[RV]) in the absolute position control mode does not have a meaning as the rotation direction. They behave as the signals for RUN/STOP. The rotation direction specifies the forward rotation if (target position - current position) is plus and the reverse rotation if minus.
- When homing function (described later) is not performed, If the Save current position at power off [AE-61] is 00, the position when the power is turned on is the origin (Current position monitor [dA-20] = 0), When [AE-61] is 01, the current position is the position at the previous power-off (value of the Current position monitor [dA-20]).
- When the deviation between the position reference and current position is 0, if the RUN command is turned on, the positioning operation is performed immediately.
- The current position reference can be monitored with the Position reference setting or monitor [FA-20].

!

- For using this function:
 - Set the Control mode selection [AA121] to 10:vector control with encoder (IM);
 - Set the Vector control mode selection [AA123] to 02:Absolute position control or 03:High-resolution absolute position control;
- This function requires using the encoder feedback
- See also "12.9.17 Use Encoder".
- When the Vector control mode selection [AA123] is set to 03:High-resolution absolute position control, the control is performed with the 4 multiplication number of pulses used for the internal calculation. (Set the multistage position reference and position range designation with the 4 multiplication accuracy.)
- The position reference can be switched at a maximum of 16 stages in combination of the input terminals.
- The trip reset or reset signal input does not clear the current position counter.
- When the PCLR terminal is assigned, turning on the PCLR terminal clears the current position counter.
- In the absolute position control mode, the ATR terminal is disabled. (The torque control does not operate.)
- In the absolute position control mode, the STAT terminal is disabled. (The pulse train position control does not operate.)

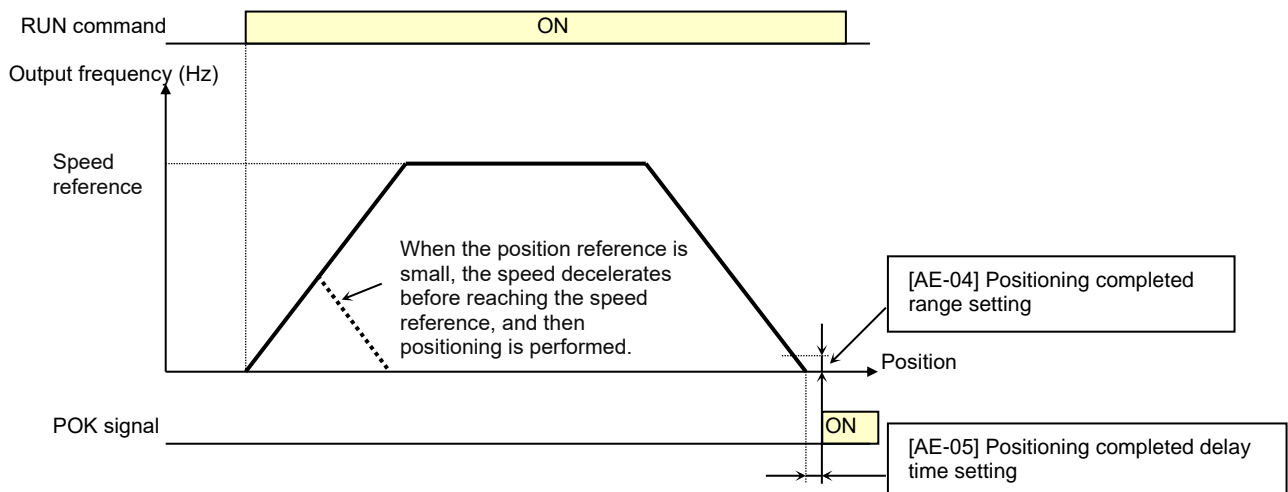

■ Shortest Position Control.

- When the Position control mode selection is [AE-56] set to 01 (without limit), the rotation direction is determined so that the moving distance to a target position is the shortest for applications such as a turntable.

Application example) A turntable with eight positioning points.

- Assume a case of moving from the current position (1000 pulse) to the target position (6000 pulse).
- When [AE-56] = 00 (with limit), Since (target position) - (current position) = +5000 pulse, the rotation is in the forward direction.
- When [AE-56] = 01 (without limit), the move is in the reverse direction with the shorter moving distance comparing the forward and reverse directions.

Moving distance in the forward direction: +5000 pulse
 Moving distance in the reverse direction: -3000 pulse

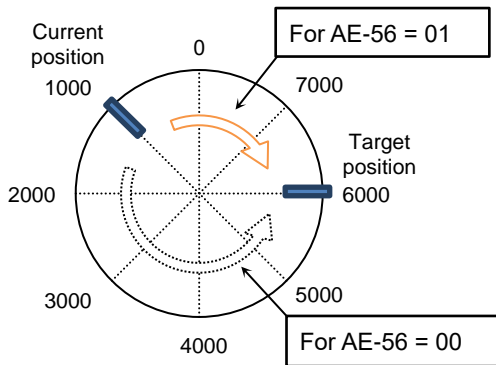

- For the above example, Set the Position control range setting (forward) [AE-52] = 7999 and the Position control range setting (reverse) [AE-54]= 0. Also, each positioning point is required to be set in this range.
- Depending on the setting for the position range designation, the following settings are also allowed.
 [AE-52]=3999
 [AE-54]=-4000

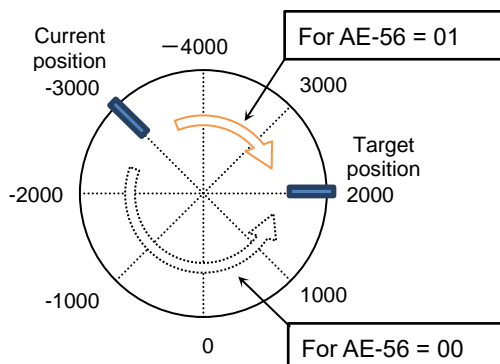

- When [AE-56] = 01, the [E104] position control range error does not occur.
- In the case of the example on the left, when moving from the position of 7000pls to the position of 1000pls, the current position counter next to the forward rotation side position range 7999 pulse becomes 0 pulse instead of 8000 pulse, and then moves to the position of 1000pls.

■ Multistage Position Switching Function.

- By combining 076[CP1] to 079[CP4] input terminals, the multistage position 0 to 15 can be switched.
- For the multistage position settings, use the Position reference 0 to 15 ([AE-20] to [AE-50]).
- When there no terminal assignments, the Position reference 0 [AE-20] becomes the multistage position 0.

Position reference	CP4	CP3	CP2	CP1
Multistage position 0	OFF	OFF	OFF	OFF
Multistage position 1	OFF	OFF	OFF	ON
Multistage position 2	OFF	OFF	ON	OFF
Multistage position 3	OFF	OFF	ON	ON
Multistage position 4	OFF	ON	OFF	OFF
Multistage position 5	OFF	ON	OFF	ON
Multistage position 6	OFF	ON	ON	OFF
Multistage position 7	OFF	ON	ON	ON
Multistage position 8	ON	OFF	OFF	OFF
Multistage position 9	ON	OFF	OFF	ON
Multistage position 10	ON	OFF	ON	OFF
Multistage position 11	ON	OFF	ON	ON
Multistage position 12	ON	ON	OFF	OFF
Multistage position 13	ON	ON	OFF	ON
Multistage position 14	ON	ON	ON	OFF
Multistage position 15	ON	ON	ON	ON



- When inputting the Multistage position settings selection1 to 4, the waiting time until the terminal input is fixed can be set. The transition state before the input is fixed can be prevented from being adopted as the input.
- With the Multistage input determination time [CA-55], the fixing time can be adjusted. Finally, after the [CA-55] setting time passes without any changes of the input, the data is fixed. (Note that a longer fixing time causes a bad performance of the input response.)
- Example using [CP1] to [CP3] as the input terminals

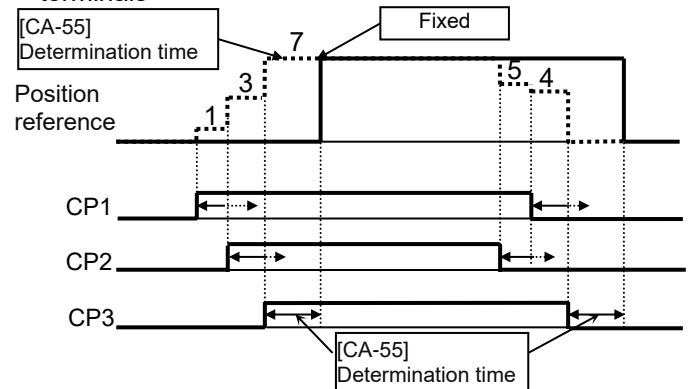

■ Speed/Position Switching Function

- Turn on the input terminal function 084 [SPD] when the speed control operation is performed in the absolute position control mode.
- While the 084[SPD] terminal is on, the current position counter is 0. Therefore, when the [SPD] terminal is turned off during the operation, the position control operation starts at that time. (Speed/position switching)



- When switching the speed to position, if the deviation between the position reference and current position is 0, the stop operation is performed immediately. (Depending on the position loop gain, there is a possibility of hunting)
- Also, while the [SPD] terminal is on, there is a move in the direction depending on the RUN command. For switching the speed to position, note the sign of the command.

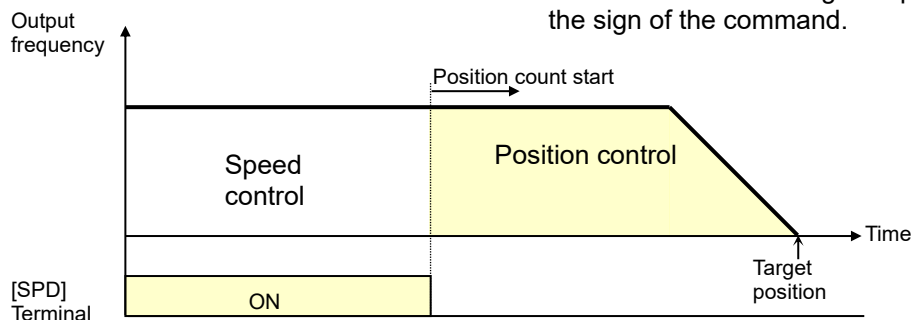

■ Teaching Function

- Function to rotate and stop a motor and store the position as a position reference at any position reference area.
- In position teaching, the Teach-in function target selection [AE-60] is used to store the actual position (value of the Current position monitor [dA-20]) in any parameter from the position reference 0[AE-20] to the position reference 15[AE-50].

[Teaching method]

- (1) Move the workpiece to the position where you want to memorize it by normal operation or manual operation.
- (2) Select X00 to X15 with [AE-60] and save. By this operation, the position data of the Current position monitor [dA-20] is stored in the Position reference 0 [AE-20] to the Position reference 15 [AE-50]. (X00 to X15 corresponds to [AE-20] to [AE-50]. Refer to the table on the right.)

[Teaching procedure example during absolute position control operation]

- (1) Select the position reference number to be set in the Teach-in function target selection [AE-60]. (Do not press the F2 (save) key on the keypad.)
- (2) Move the work piece.
Turn on the 110[TCH] terminal to change the control mode to speed control, then enter the RUN command (speed reference, acceleration time and deceleration time depends on the setting at this time).
- (3) When the work reaches the target position, press the F2 (save) key on the keypad VOP. As a result, the current position is saved to the position reference number (refer to the table on the right) set in the Teach-in function target selection [AE-60]. (Position saving does not depend on the ON / OFF status of [TCH].)
- (4) If the position is memorized continuously, repeat from step (1).

(Note: Values are not saved in [AE-60]. It becomes 0 when the power is cut off or reset.)

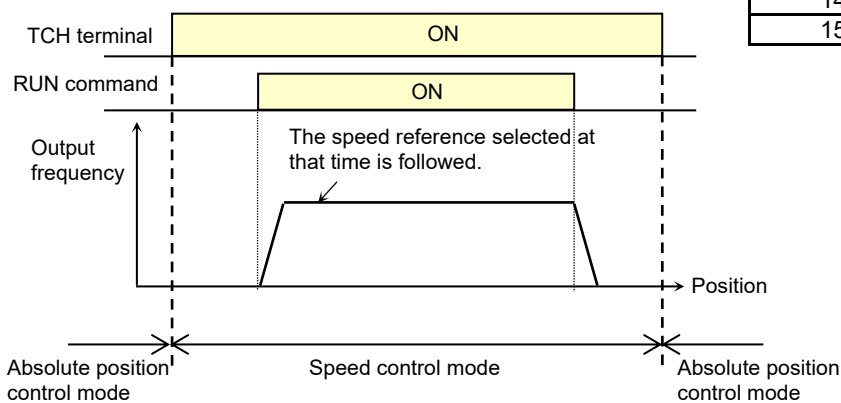

- Teaching is possible if the inverter control circuit power supply (R0, T0) is input. Even if the workpiece is moved by an external device, the current position counter will change if there is an encoder feedback input. Teaching is possible without operating the inverter.



- However, make sure that the power supply of the inverter power circuit (R, S, T) is shut off. Or make sure that the connection between the output of the inverter (U, V, W) and the motor is shut off. Otherwise, you run the risk of injury and damage.



- [AE-60] should not be used for purposes other than position teaching. Regardless of the control mode or operation status, The corresponding absolute position reference parameter ([AE-20] to [AE-50]) is changed to Current position monitor [dA-20] when select X00 to X15 with [AE-60] and press the F2 (Save) key on the keypad VOP.

[AE-60] setting value	Position reference to be set
00	[AE-20]: Position reference 0
01	[AE-22]: Position reference 1
02	[AE-24]: Position reference 2
03	[AE-26]: Position reference 3
04	[AE-28]: Position reference 4
05	[AE-30]: Position reference 5
06	[AE-32]: Position reference 6
07	[AE-34]: Position reference 7
08	[AE-36]: Position reference 8
09	[AE-38]: Position reference 9
10	[AE-40]: Position reference 10
11	[AE-42]: Position reference 11
12	[AE-44]: Position reference 12
13	[AE-46]: Position reference 13
14	[AE-48]: Position reference 14
15	[AE-50]: Position reference 15

■ Homing Function

A

- With the [AE-70] Homing function selection, three types of zero return operations are performed. Once the zero return completes, the current position is cleared (= 0).
- When using the Homing function, assign 081 [ORG] Start signal of Homing function and 080 [ORL] Limit signal of Homing function to the intelligent input terminal function.

- The direction of the [AE-71] Direction of homing function is selected with the homing direction selection.
- When the homing is not performed, the position at power-on follows the [AE-61] Save current position at power off and the position control is performed.

■ Low Speed Homing ([AE-70] = 00).

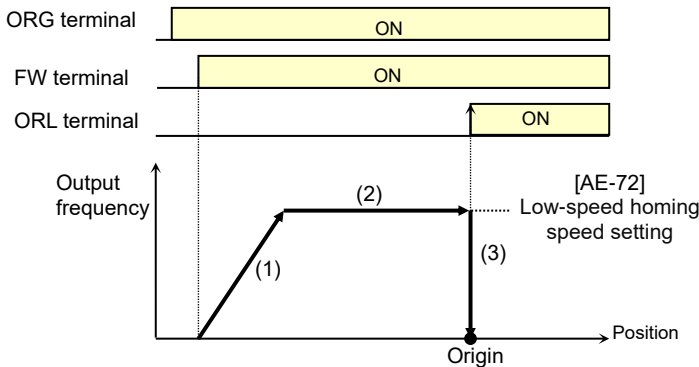

- (1) Follows the acceleration time to accelerate to the low speed homing speed.
- (2) Operates at the low speed homing speed.
- (3) Positioning when the ORL signal is input.

■ High Speed Homing 1 ([AE-70] = 01).

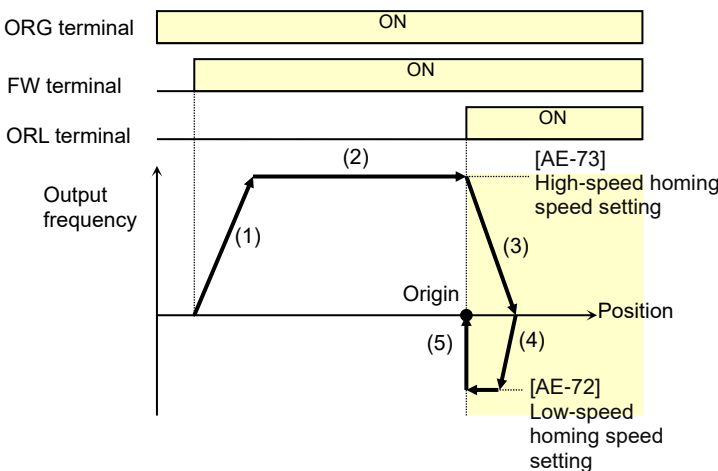

- (1) Follows the acceleration time to accelerate to the high speed homing speed.
- (2) Operates at the high speed homing speed.
- (3) Starts the deceleration when the ORL signal is turned on.
- (4) Operates in the reverse rotation direction at the low speed homing speed.
- (5) Positioning when the ORL signal is turned off.

■ High Speed Homing 2 ([AE-70] = 02).

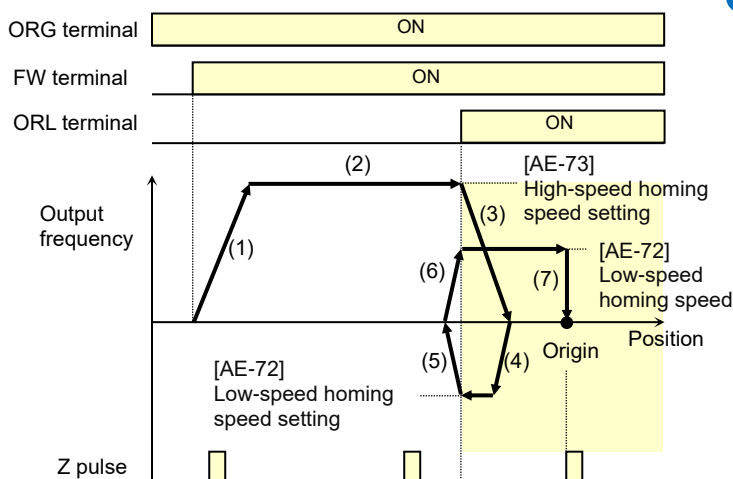

- (1) Follows the acceleration time to accelerate to the high speed homing speed.
- (2) Operates at the high speed homing speed.
- (3) Starts the deceleration when the ORL signal is turned on.
- (4) Operates in the reverse rotation direction at the low speed homing speed.
- (5) Starts the deceleration when the ORL signal is turned off.
- (6) Operates in the forward rotation direction at the low speed homing speed.
- (7) Positioning at the first Z pulse after the ORL signal is turned on.

■ Forward/Reverse Over Travel Function (FOT/ROT).

- Function to prevent the operation range from being deviated using the signal from the control range limit switch.
- The torque limit is restricted to 10% on the forward rotation side when the 082[FOT] terminal is input and on the reverse rotation side when the 083[ROT] terminal is input. This is applicable as the limit switch at the edge of the machine.

■ Position Range Designation Function.

- Specify the position control range at the [AE-52] Position control range setting (forward) /[AE-54] Position control range setting (reverse).
- When the current position counter exceeds this setting, there is a trip with the position control range error (E104) and the inverter becomes the free-running status.

■ Position Memory at Power-Off.

- By setting the [AE-61] Save current position at power off to 01, the current position data at power-off can be stored.
- Use this for the application where the shaft of the motor is locked at power-off.



- For the machine of which the shaft idles at power-off, there is likely to be a gap between the stored position and the current position when the power is turned on again.

■ Position Data Preset.

- When the 085[PSET] terminal is turned on, the current position counter (can be monitored with [dA-20]) is overwritten with the value set to the [AE-62] preset position data.
- Available for restarting in the middle of the positioning process, etc. (Data is overwritten at the ON edge of the [PSET] terminal.)

■ Position Control Related Parameters.

Name	Code	Data range (unit)	Description
Control mode selection, 1st-motor	[AA121]	10	Vector control with encoder (IM)
Vector control mode selection, 1st-motor	[AA123]	02	Absolute position control
		03	High resolution absolute position control
Position reference 0	[AE-20]	[AE-54] to [AE-52]	Set the position reference for the multistage speed command to each.
Position reference 1	[AE-22]	[AE-54] to [AE-52]	
Position reference 2	[AE-24]	[AE-54] to [AE-52]	
Position reference 3	[AE-26]	[AE-54] to [AE-52]	
Position reference 4	[AE-28]	[AE-54] to [AE-52]	
Position reference 5	[AE-30]	[AE-54] to [AE-52]	
Position reference 6	[AE-32]	[AE-54] to [AE-52]	
Position reference 7	[AE-34]	[AE-54] to [AE-52]	
Position reference 8	[AE-36]	[AE-54] to [AE-52]	
Position reference 9	[AE-38]	[AE-54] to [AE-52]	
Position reference 10	[AE-40]	[AE-54] to [AE-52]	
Position reference 11	[AE-42]	[AE-54] to [AE-52]	
Position reference 12	[AE-44]	[AE-54] to [AE-52]	
Position reference 13	[AE-46]	[AE-54] to [AE-52]	
Position reference 14	[AE-48]	[AE-54] to [AE-52]	
Position reference 15	[AE-50]	[AE-54] to [AE-52]	
Position control range setting (forward)	[AE-52]	Condition 1: 0 to +268435455 (pls) Condition 2: 0 to +1073741823 (pls)	Condition 1: Except for the condition 2 Condition 2: [AA121] = 10, [AA123] = 03
Position control range setting (reverse)	[AE-54]	Condition 1: -268435455 to 0 (pls) Condition 2: -1073741823 to 0 (pls)	Condition 1: Except for the condition 2 Condition 2: [AA121] = 10, [AA123] = 03
Position reference setting or monitor	[FA-20]	Condition 1: -268435455 to +268435455 (pls) Condition 2: -1073741823 to +1073741823 (pls)	Condition 1: Except for the condition 2 Condition 2: [AA121] = 10, [AA123] = 03

■ Position Control Related Parameters.

Name	Code	Data range (unit)	Description
Position control mode selection	[AE-56]	00	With limit
		01	Without limit
Teach-in function target selection	[AE-60]	00	Position reference 0 (AE-20)
		01	Position reference 1 (AE-22)
		02	Position reference 2 (AE-24)
		03	Position reference 3 (AE-26)
		04	Position reference 4 (AE-28)
		05	Position reference 5 (AE-30)
		06	Position reference 6 (AE-32)
		07	Position reference 7 (AE-34)
		08	Position reference 8 (AE-36)
		09	Position reference 9 (AE-38)
		10	Position reference 10 (AE-40)
		11	Position reference 11 (AE-42)
		12	Position reference 12 (AE-44)
		13	Position reference 13 (AE-46)
		14	Position reference 14 (AE-48)
15	Position reference 15 (AE-50)		
Save current position at power off	[AE-61]	00	Disabled
		01	Enabled
Pre-set position data	[AE-62]	Condition 1: -268435455 to +268435455 (pls) Condition 2: -1073741823 to +1073741823 (pls)	Condition 1: Except for the condition 2 Condition 2: [AA121] = 10, [AA123] = 03
Reset mode selection	[CA-72]	02	Only enable in trip status. (Trip release at turned ON.)
		03	Only enable in trip status. (Trip release at turned OFF.)
Input terminal function	[CA-01] to [CA-11]	072	PCLR: Clearance of position deviation
		076	CP1: Multistage position settings selection 1
		077	CP2: Multistage position settings selection 2
		078	CP3: Multistage position settings selection 3
Current position monitor	[dA-20]	Condition 1: -536870912 to +536870911 (pls) Condition 2: -2147483648 to +2147483647 (pls)	Condition 1: Except for the condition 2 Condition 2: [AA121] = 10, [AA123] = 03



- If the absolute position control is changed to high resolution absolute position control ([AA121] = 10, [AA123] = 03), the settings for the following parameters are quadrupled:
 - Position reference setting or monitor [FA-20];
 - Position reference 0 to 15 ([AE-20] to [AE-50]);
 - Position control range setting (forward) [AE-52];
 - Position control range setting (reverse) [AE-54];
 - Pre-set position data [AE-62];

(Example)

When [FA-20] = 1000 pulse and the mode setting is changed from absolute position control to high resolution absolute position control, the display of [FA-20] is 4000 pulse.

■ Homing Related Parameters.

Name	Code	Data range (unit)	Description
Homing function selection	[AE-70]	00	Low speed
		01	High speed 1
		02	High speed 2
Direction of homing function	[AE-71]	00	Forward rotation
		01	Reverse rotation
Low-speed homing speed setting	[AE-72]	0.00 to 10.00(Hz)	Speed in the low speed Homing mode.
High-speed homing speed setting	[AE-73]	0.00 to 590.00(Hz)	Speed in the high speed Homing mode.
Input terminal function	[CA-01] to [CA-11]	072	PCLR: Clearance of position deviation
		076	CP1: Multistage position settings selection 1
		077	CP2: Multistage position settings selection 2
		078	CP3: Multistage position settings selection 3
		079	CP4: Multistage position settings selection 4
		080	ORL: Limit signal of Homing function
		081	ORG: Start signal of Homing function
		082	FOT: Forward Over Travel
		083	ROT: Reserve Over Travel
		084	SPD: speed / position switching
		085	PSET: Position data presetting
		110	TCH: Teach-in signal

12.17.10 Servo Lock Using the Input Terminal Function



- How to fixed stop the shaft so that it does not move due to the load during position control.
- How to lock a motor while it stops using vector control.



- This is valid when the Control mode selection [AA121] is 09:Zero-Hz-range sensorless vector control(IM) or 10:Vector control with encoder(IM).
- When [SON] is assigned to the input terminal function, the RUN command is not accepted unless [SON] is turned on.



- This function makes a motor the servo lock status with the input terminal function 065 [SON] Servo-on.
- Assigning the input terminal function 065 [SON] triggers this function

- If [SON] is turned off while the inverter is in running, the operation of the STOP mode selection [AA115] is followed. When the free-running occurs, restarting follows the setting of the Restart mode after FRS release [bb-40].
- When the Forcing (Pre-excitation) function [FOC] is assigned to the input terminal, the input terminal [SON] does not work.

■ For the STOP mode selection [AA115] is 00.

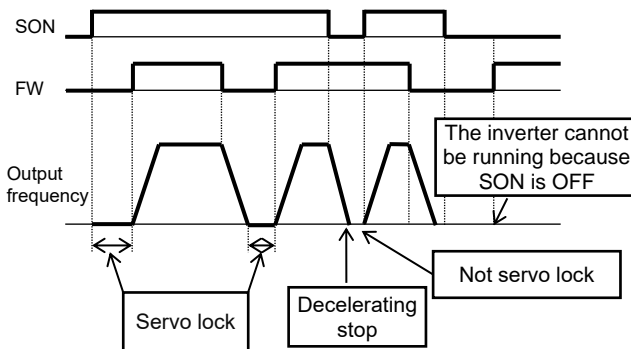

■ For the STOP mode selection [AA115] is 01.

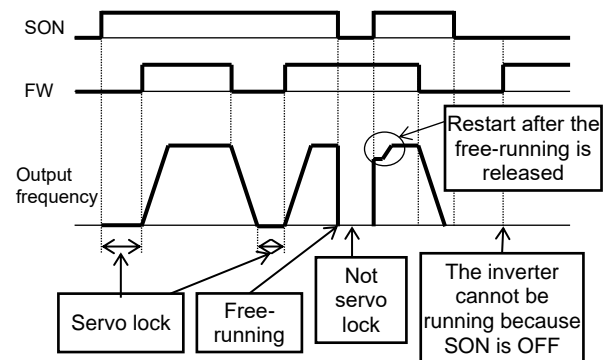

■ Parameters.

Name	Code	Data range (unit)	Description
Input terminal function	[CA-01] to [CA-11]	065	SON: the inverter performs servo-lock.
STOP mode selection, 1st-motor	[AA115]	00	Deceleration stop is performed when the RUN command is turned off.
		01	Free-running is performed when the RUN command is turned off.
Restart mode after FRS release	[bb-40]	00	Restart at 0Hz
		01	Restart with frequency matching *1)
		02	Restart with active frequency matching *2)
		03	Detect speed *3)
Retry wait time after instantaneous power failure/under-voltage error	[bb-26]	0.3 to 100.0 (s)	Set the waiting time before restart.

*1) Refer to "12.14.3 Starting with Frequency Matching".

*2) Refer to "12.14.4 Starting with Active Frequency Matching".

*3) When 03 (detection speed) is selected, feedback input to input terminals A and B or feedback input to option P1-FB is required.



- If the torque at the time of start is insufficient, it may be improved by the Boost value at start [HC111], [HC112] or Speed response [HA115]. Refer to "12.9 Select the Appropriate Control Mode for the Motor and Load".
- If the torque at the time of start is insufficient, it may be improved by using the torque bias function. Refer to "12.11.6 Torque Bias Function Settings".

(Memo)

12.18 Controlling the Cooling Fan of the Inverter

12.18.1 Selecting the Operation of the Cooling Fan

Q

- How to run the cooling fan of the inverter all the time.
- How to cool the inverter only while it is operating.
- How to stop the sound of the cooling fan while the inverter is in stop.
- How to cool the inverter only when it is generating heat.



- When the instantaneous power failure or power-off occurs while the cooling fan is in running, it is suspended regardless of the Cooling fan control method selection [bA-70], and automatically resumes after the restoration of power.

A

- The behaviors of the cooling fan is able to set by the Cooling fan control method selection [bA-70].
- For [bA-70]=00, the cooling fan runs all the time.
- For [bA-70]=01, the cooling fan runs when the inverter is in running. The fan runs for 3 minutes after the operation stops.
- For [bA-70]=02, the cooling fan runs depending on the temperature of the heat sink detected by the inverter.

Parameters.

Name	Code	Data range (unit)	Description
Cooling fan control method selection	[bA-70]	00	Always ON : The cooling fan runs all the time while power supply on.
		01	While the inverter is in running : The cooling fan runs automatically when the inverter becomes the running status. The cooling fan continuously runs for 3 minutes after the inverter stops and then automatically stops. * In addition, regardless of whether the inverter is running or stopped, the cooling fan runs when the heat sink temperature of the inverter exceeds 60 °C, and stops when the heat sink temperature continues under 50 °C for 3 minutes or longer.
		02	Depends on temperature : The cooling fan runs when the heat sink temperature of the inverter exceeds 40°C. If the heat sink temperature is under 40°C for more than 3 minutes, the cooling fan automatically stops.

A

- For checking the heat sink temperature, see "13.10 Checking the Inverter Temperature".
- For the replacement timing of the cooling fan, see "13.12.2 Checking the Cumulative Running Time of Cooling Fan".

12.19 How to Output Warning Signals

12.19.1 Outputting an Alarm Signal



- I want to detect the error state of the inverter and make a notification to the system.



- Assign the output terminal function 017 [AL] alarm signal to one of [CC-01] to [CC-07] that corresponds to the output terminal and output the signal.
- The [AL] function is assigned in the initial state to the contact c relay [CC-07] of AL1-AL0 and AL2-AL0.
- You can set the output specifications of contacts a and b to output terminals 11-15, relay output terminals 16A-16C, AL1-AL0/AL2-AL0 individually. (The a / b contact setting is parameter [CC-11] to [CC-17]).

■ Alarm relay AL.

- The operations of AL1-AL0 and AL2-AL0 are as follows.

[CC-17]	Control power	Inverter error output	Output terminal state	
			AL1-AL0	AL2-AL0
00	On	Abnormal	Close	Open
		Normal	Open	Close
	Off	-	Open	Close
		-	Open	Close
01	On	Abnormal	Open	Close
		Normal	Close	Open
	Off	-	Open	Close
		-	Open	Close

(Factory default value of [CC-17] is 01.)

- The specifications of the relay contacts AL1-AL0 and AL2-AL0 are as follows.

		Resistive load	Inductive load
AL1-AL0	Maximum contact capacity	250 VAC, 2 A 30 VDC, 3 A	250 VAC, 0.2 A 30 VDC, 0.6 A
	Minimum contact capacity	100 VAC, 10 mA 5 VDC, 100 mA	
AL2-AL0	Maximum contact capacity	250 VAC, 1 A 30 VDC, 1 A	250 VAC, 0.2 A 30 VDC, 0.2 A
	Minimum contact capacity	100 VAC, 10 mA 5 VDC, 100 mA	



- If the system recognizes an interruption of the inverter power supply as an error, this symptom may be alleviated by changing the wiring and the selection of contacts.
- In the factory default, AL2-AL0 is "closed" when the power is off, and "open" when there is no error in the inverter with power on. (See table for alarm relay AL at bottom left).
If there is a problem with the above condition, set [CC-17] to 00 or change the error detection sequence.

■ Relay output 16C.

- The operations of 16C are as follows.

[CC-16]	Control power	Functional operation	Output terminal state
00	On	ON	Close
		OFF	Open
	Off	-	Open
01	On	ON	Open
		OFF	Close
	Off	-	Open

(Factory default value of [CC-17] is 00.)

- The specifications of the relay contact 16C is as follows.

		Resistive load	Inductive load
16A-16C	Maximum contact capacity	250 VAC, 2 A 30 VDC, 3 A	250 VAC, 1 A 30 VDC, 0.6 A
	Minimum contact capacity	5 VDC, 10 mA	

■ Parameters.

Name	Code	Data range (unit)	Description
Output terminal function [11] to [16], [AL]	[CC-01] to [CC-07]	017	An alarm signal is output to the output terminal to which 017 [AL] has been assigned. ON: When an alarm has occurred OFF: When no alarm has occurred
Output terminal active state [11] to [16] (a / b (NO/NC selection))	[CC-11] to [CC-16]	00	Operates as contact a (NO).
		01	Operates as contact b (NC).
Output terminal active state [AL] (a / b (NO/NC selection))	[CC-17]	00	See the previous page
		01	

A

- Contact a:
The contact closes when the functional operation is ON and opens when OFF.
- Contact b:
The contact closes when the functional operation is OFF and opens when ON.

Example: [E001] occurred when the current reached the overcurrent level.

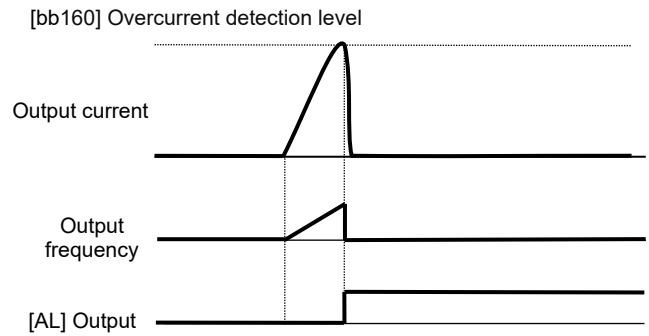

12.19.2 Outputting a Major Failure Signal

Q

- I want to detect an unrecoverable error condition of the inverter and notify the system.

A

- Assign the output terminal function 018 [MJA] Major failure signal to one of [CC-01] to [CC-07] that corresponds to the output terminal and output the signal.
- Trips that are evaluated as serious faults are as follows.



- The inverter hardware may have a fault when this signal is output. Check the error history and deal with the situation appropriately.
- When these trips occur, the error cannot be released by resetting. However, the [E020] (Cooling fan rotation speed reduction temperature error) can be reset if the inverter temperature drops sufficiently.

Error code	Name	Description
E008	Memory error	The memory element of the inverter is under an abnormal condition.
E010	Current detector error	The current detector of the inverter is under an abnormal condition.
E011	CPU error	The drive CPU of the inverter is under an abnormal condition.
E014	Ground fault error	The inverter has a ground fault.
E019	Temperature detector error	The temperature detector of the inverter is under an abnormal condition.
E020	Cooling fan rotation speed reduction temperature error	The cooling fan rotation speed of the inverter has reduced, preventing the inverter from dissipating heat.

■ Parameter

Name	Code	Data range (unit)	Description
Output terminal function [11] to [16], [AL]	[CC-01] to [CC-07]	018	[MJA]: The signal is output from the output terminal to which 018 [MJA] is assigned when a serious failure error occurs. OFF: No serious fault is occurred. ON: A serious fault is occurred.

12.19.3 Outputting the Trip Type to Output Terminals by Bit Code

Q

- I want to detect the error type of the inverter and make a notification to the system.

A

- Assign the output terminal functions 084 [AC0] to 087 [AC3] alarm code to one of [CC-01] to [CC-07] that corresponds to the output terminal and output the signal.
- The 4-bit output mode is selected when 087 [AC3] is assigned to the output terminal function, whereas the 3-bit output mode is selected when it is not assigned.
- The table next page shows the alarm codes to be output.



- The output state switches depending on whether 087 [AC3] has been set to [CC-01] to [CC-07]. The 4-bit output mode is selected when 087 [AC3] has been set, and the signals 084 [AC0], 085 [AC1], 086 [AC2], and 087[AC3] will be output in accordance with the table next page even when all of them have not been set.
- The signals will be output in the 3-bit mode when one of or any two from 084 [AC0], 085 [AC1], and 086 [AC2] have been set. The signals 084 [AC0], 085 [AC1], and 086 [AC2] will be output in accordance with the table next page even when all of them have not been set.

Parameter

Name	Code	Data range (unit)	Description
Output terminal function [11] to [16], [AL]	[CC-01] to [CC-07]	084 to 087	084: [AC0] alarm code bit 0 085: [AC1] alarm code bit 1 086: [AC2] alarm code bit 2 087: [AC3] alarm code bit 3 The signal is output when a trip occurs at the output terminal assigned.

■ Trip code

Output terminal function				When a 4-bit code is selected (with [AC3])		When a 3-bit code is selected (without [AC3])	
AC3	AC2	AC1	AC0	Cause code	Trip description	Cause code	Trip description
0	0	0	0	Normal	Normal	Normal	Normal
0	0	0	1	E001	Overcurrent error	E001	Overcurrent error
0	0	1	0	E005, E038, E039	Motor overload error, Low-speed range overload error, Controller(Inverter) overload error	E005, E038, E039	Motor overload error, low-speed range overload error, controller overload error
0	0	1	1	E007, E015	Overvoltage, Power supply overvoltage error	E007, E015	Overvoltage, Power supply overvoltage error
0	1	0	0	E009	Undervoltage error	E009	Undervoltage error
0	1	0	1	E016	Instantaneous power failure error	E016	Instantaneous power failure error
0	1	1	0	E030	IGBT error	E030	IGBT error
0	1	1	1	E006	Braking resistor overload error	-	Other than above
1	0	0	0	E008, E011	Memory error, CPU error	-	-
1	0	0	1	E010, E019	Current detector error, Temperature detector error	-	-
1	0	1	0	E012, E013, E035, E036	External trip error, USP error, Thermistor error, Break error	-	-
1	0	1	1	E014	Ground fault error	-	-
1	1	0	0	E040, E041, E042, E043, E044, E045	Operator keypad disconnection error, RS485 communication error, RTC error, EzSQ invalid instruction error, EzSQ nesting count error, EzSQ execution error	-	-
1	1	0	1	E020, E021	Cooling fan rotation speed reduction temperature error, Temperature error,	-	-
1	1	1	0	E024, E034	Input open-phase error, Output open-phase error	-	-
1	1	1	1	Other than above	EzSQ assignment error 0 to 9, etc.	-	-

12.19.4 Outputting a Warning Depending on the Overload Conditions



- I want to know an increase in the output current of the motor from a warning signal.
- I want to know the increase in motor current before the alarm occurs.



- Assign the output terminal functions 035 [OL] and 036 [OL2] Overload warning notice signals to the [CC-01] to [CC-07] that corresponds to the output terminal and output the signal.
- The Overload warning notice signal [OL] and [OL2] will be output when the output currents exceed the corresponding overload warning level.
- By changing the Overload signal output mode selection [CE105], the method of signal output can be changed depending on the running status of the inverter.
- This function is effective, for conveyors, processing machines, etc., to prevent machine failure that may occur when the load increases, or to prevent the machines from stopping due to an overload error of the inverter.



- An Overcurrent error [E001] may occur before [OL] or [OL2] signals are output when the overload warning level is set too high. In this case, reduce the overload warning level settings.
- When the Overload signal output mode selection [CE105] is set 01(valid only in constant speed) and the frequency reference input source is analog input, it may not be judged as a constant speed because the frequency reference fluctuates finely, therefore the overload warning signal may not be output. In this case, set [CE105] to 00 (valid in running).

■ When [CE105] = 00 (Valid in running).

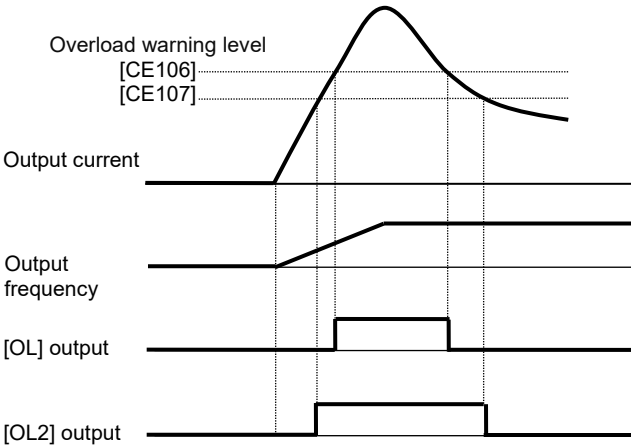

■ When [CE105] = 01(Valid only in constant speed).

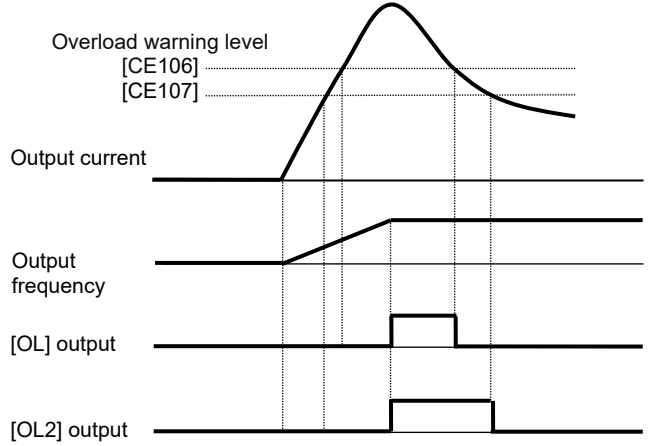

■ Parameter.

Name	Code	Data range (unit)	Description
Output terminal function selection [11] to [16], [AL]	[CC-01] to [CC-07]	035 036	035 [OL]: Overload warning notice signal is output. 036 [OL2]: Overload warning notice 2 signal is output. OFF: Less than the overload warning level. ON: More than or equal to the overload warning level.
Overload signal output mode selection, 1st motor	[CE105]	00	Valid in running.
		01	Valid only in constant speed.
Overload warning level 1, 1st motor	[CE106]	(0.0 to 2.0) x inverter rated current (A)	Sets the output current level at which the overload warning notice signal is output. The signal is output when the output current exceeds this setting.
Overload warning level 2, 1st motor	[CE107]		

12.19.5 Outputting a Warning when the Current is Low

Q

- I want to make a notification with a warning about a decrease in the output current of the motor.
- I want to detect a decrease in the motor current when the dropout in the load occurs.

A

- Assign the output terminal functions 033 [LOC] and 034 [LOC2] Low-current indication signals to the [CC-01] to [CC-07] that corresponds to the output terminal and output the signal.
- The Low-current indication signal can be output when the load is reduced.
- The Low-current indication signals 033 [LOC] and 034 [LOC2] is output when the output current becomes lower than the Low current detection level [CE102] and [CE103], respectively.
- By changing the Low current signal output mode selection [CE101], the method of signal output can be changed depending on the running status of the inverter.

!

- When the Low current signal output mode selection [CE101] is set 01(valid only in constant speed) and the frequency reference input source is analog input, it may not be judged as a constant speed because the frequency reference fluctuates finely, therefore the Low-current indication signal may not be output. In this case, set [CE101] to 00 (valid in running).

■ When [CE101] = 00 (Valid in running).

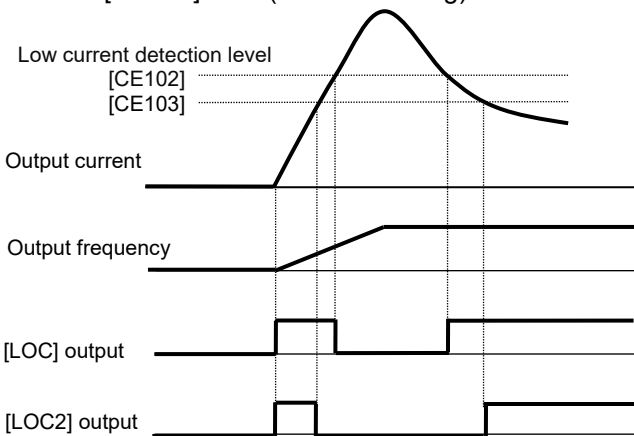

■ When [CE101] = 01 (Valid only in constant speed).

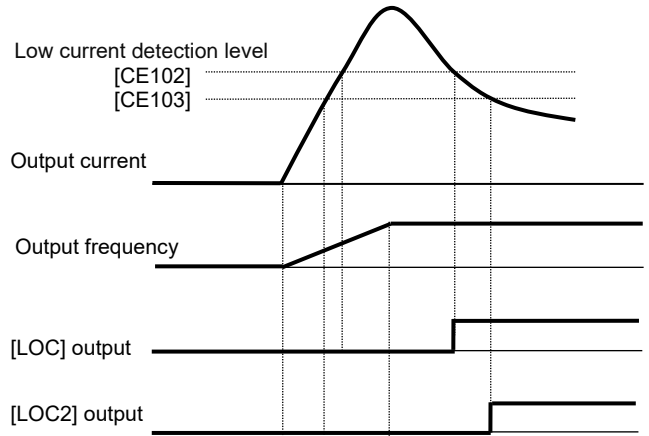

■ Parameters.

Name	Code	Data range (unit)	Description
Output terminal function [11] to [16], [AL]	[CC-01] to [CC-07]	033/ 034	033 [LOC]: Low-current indication signal is output. 034 [LOC2]: Low-current indication 2 signal is output. OFF: More than or equal to the low current detection level ON: Less than the low current detection level
Low current signal output mode selection, 1st motor	[CE101]	00 01	Valid in running Valid only in constant speed
Low current detection level 1, 1st motor	[CE102]	(0.0 to 2.0) x inverter rated current (A)	Sets the current level at which the low current warning signal is output. The signal is output when the output current becomes lower than this setting.
Low current detection level 2, 1st motor	[CE103]		

12.19.6 Outputting a Warning when an Instantaneous Power Failure Occurs

Q

I want to make a notification with a warning when an instantaneous power failure occurs.

A

- Assign the output terminal function 020 [IP] Instantaneous power failure signal to the [CC-01] to [CC-07] that corresponds to the output terminal and output the signal.
- The [IP] signal can be output when an instantaneous power failure occurs in the inverter main power supply.
- When the power supply to the control power supply (R0,T0) separately (J51 terminal is removed) , the instantaneous power failure signal is output when the main power supply (R,S,T) is shut off.

!

- The instantaneous power failure signal [IP] is valid when power supply is input to the main power (R,S,T) terminals.
- The [IP] signal is output as long as the control circuit power of the inverter remains (including external 24 VDC power supply input to P+/P-).
- For the behavior settings of the inverter when an instantaneous power failure occurs, see "12.16.6 Detecting Instantaneous Power Failure and Under-Voltage".
- For details of the restarting the inverter without an error when an instantaneous power failure occurs, see "12.13.7 Restarting After Instantaneous Power Failure Recovery".

■ Example of instantaneous power failure signal.

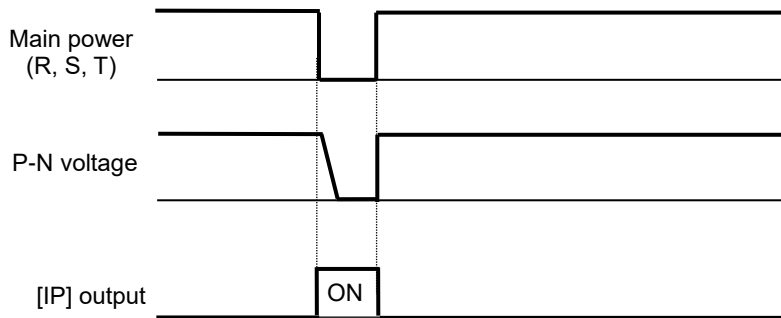

■ Parameter

Name	Code	Data range (unit)	Description
Output terminal function [11] to [16], [AL]	[CC-01] to [CC-07]	020	[IP]: The instantaneous power failure signal is output. OFF: Main power supply (R,S,T) is established. ON: Main power supply (R, S, T) established and then shut off.

12.19.7 Outputting a Warning when an Undervoltage Occurs



- I want to make a notification with a warning when an undervoltage occurs.



- Assign the output terminal function 021 [UV] undervoltage signal to the [CC-01] to [CC-07] that corresponds to the output terminal and output the signal.
- The [UV] undervoltage signal can be output when a power failure occurs in the main power supply (R,S,T) or control power supply (R0,T0) and control power.



- The [UV] signal is output as long as the control circuit power of the inverter remains (including external 24 VDC power supply input to P+/P-).
- For the behavior settings of the inverter when an undervoltage occurs, see "12.16.6 Detecting Instantaneous Power Failure and Under-Voltage".
- For details of the restarting the inverter without an error when an undervoltage occurs, see "12.13.6 Restarting After Under Voltage".
- The [UV] signal is output in undervoltage condition regardless of whether the inverter is in trip or not.

■ Example of an undervoltage (Main power (R,S,T) and control power (R0,T0) are supplied separately).

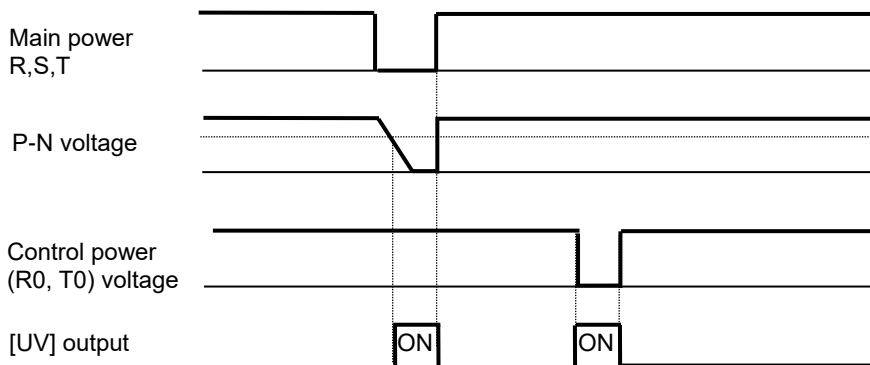

■ Parameter

Name	Code	Data range (unit)	Description
Output terminal function [11] to [16], [AL]	[CC-01] to [CC-07]	021	[UV]: The Undervoltage signal is output. OFF: P-N voltage and control power is established. ON: P-N voltage or control power is insufficient.

12.19.8 Outputting a Warning Before Thermal Protection of the Motor



- I want to check the output current and output the signal before the inverter occurs an error by the motor electronic thermal protection calculation.
- I want to cool the system before a thermal error is occurred.



- The motor overload error [E005] is occurred when the electronic thermal load rate of the motor, it can be monitored in the [dA-42], exceeds 100.00%.
- For the settings of motor electronic thermal, see “12.7.1 Electronic Thermal Settings of Motor”



- Assign the output terminal function 026 [THM] Electronic thermal alarm (Motor) signal to the [CC-01] to [CC-07] that corresponds to the output terminal and output the signal.
- The motor overload condition can be notified by this signal before the motor overload error [E005] occurs with the electronic thermal function.

■ Example operation (when the Electronic thermal function is subtraction mode)

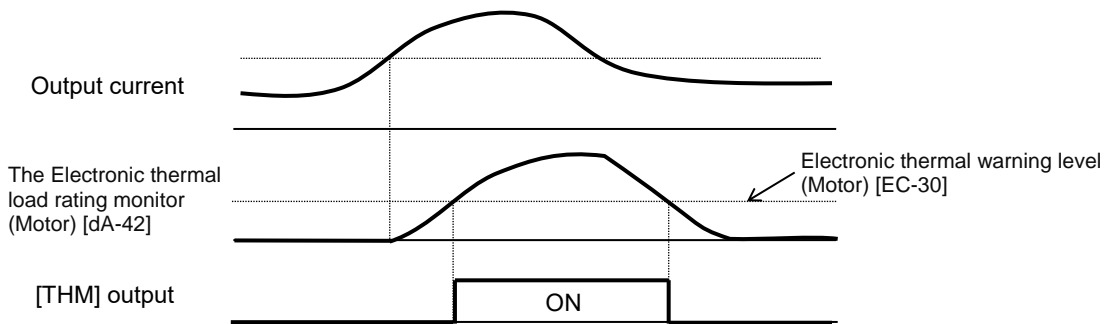

■ Parameter.

Name	Code	Data range (unit)	Description
Output terminal function [11] to [16],[AL]	[CC-01] to [CC-07]	026	[THM]: The electronic thermal alarm (Motor) signal is output. OFF: The Electronic thermal load rating monitor (Motor) [dA-42] is smaller than the electronic thermal warning level (Motor) [CE-30]. ON: Not above.
Electronic thermal warning level (Motor)	[CE-30]	0.00 to 100.00 (%)	Sets the electronic thermal load rating of the motor at which the electronic thermal alarm (Motor) signal is output. The signal is output when the electronic thermal load rating of the motor, it can be monitored at the [dA-42], exceeds this setting.

12.19.9 Outputting a Warning Before Thermal Protection of the Inverter



- I want to check the output current and output the signal before the inverter occurs an error by the inverter electronic thermal protection calculation.
- I want to cool the system before a thermal error is occurred.



- Assign the output terminal function 026 [THC] Electronic thermal alarm (Inverter) signal to the [CC-01] to [CC-07] that corresponds to the output terminal and output the signal.
- The inverter overload condition can be notified by this signal before the controller (inverter) overload error [E039] occurs with the electronic thermal function.



- The controller (inverter) overload error [E039] is occurred when the electronic thermal load rate of the inverter, it can be monitored in the [dA-43], exceeds 100.00%.
- Note that the electronic thermal characteristics of inverter are fixed for each model and cannot be changed by user parameters.



- The electronic thermal of the inverter depends on the over load current rating at ND rating regardless of the Load type selection [Ub-03] setting. Therefore, even if [Ub-03] is changed to LD or LVD, check not only LD or LVD but also ND rated current derating. For details, see “20.4 Current Derating”.
- As shown in the figure below, for protect the inverter, the thermal characteristic is reduced with the electronic thermal protection of the inverter in the low speed range below 5 Hz, so the Electronic thermal warning signal may be output faster in this speed range. In addition, the controller (inverter) overload error [E039] is also likely to occur.

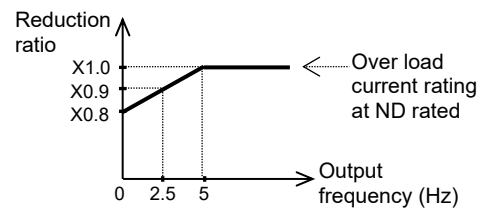

- Inverter thermal values are cleared every 10 minutes. However, integration is processed in a dual-redundant system, so that the value may not be cleared when the current is high and the integrated value increases.
- For more information on electronic thermal, see also "12.7.1 Electronic Thermal Settings of Motor", and In chapter 18 "E039 Controller (inverter) overload error".

■ Example operation.

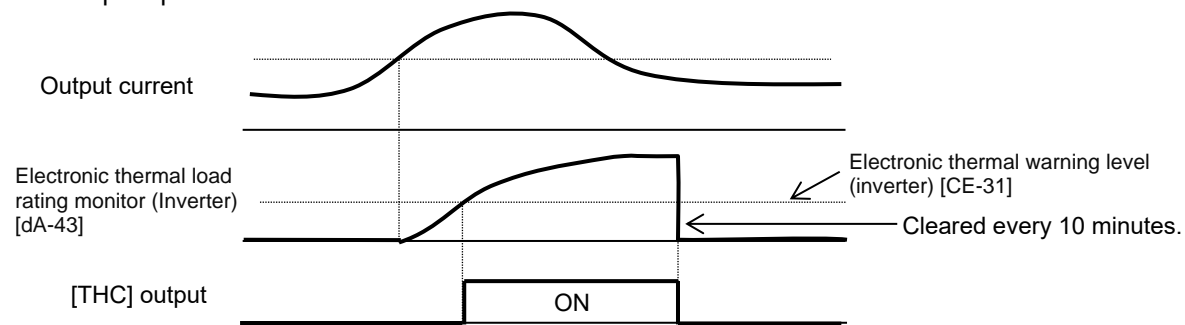

■ Parameters.

Name	Code	Data range (unit)	Description
Output terminal function [11] to [16], [AL]	[CC-01] to [CC-07]	027	[THC]: The electronic thermal alarm (Inverter) signal is output. OFF: The Electronic thermal load rating monitor (Inverter) [dA-43] is smaller than the electronic thermal warning level (Inverter) [CE-31]. ON: Not above.
Electronic thermal warning level (Inverter)	[CE-31]	0.00 to 100.00(%)	Sets the electronic thermal load rating of the inverter at which the electronic thermal alarm (inverter) signal is output. The signal is output when the electronic thermal load rating of the inverter, it can be monitored at the [dA-43], exceeds this setting.

12.19.10 Outputting a Warning when the Temperature of the Cooling Fin Increases



- I want to know a increase in the temperature of the cooling fin before a trip occurs.
- I want to cool the system before a thermal error is generated.



- The temperature error [E021] is generated when the cooling fin temperature exceeds 120°C.



- Assign the output terminal function 032 [OHF] Heat sink overheating warning signal to one of [CC-01] to [CC-07] that corresponds to the output terminal and output the signal.
- You can understand the state from the signal before the temperature error [E021] is generated by the cooling fin heating warning level function.

■ Operation example

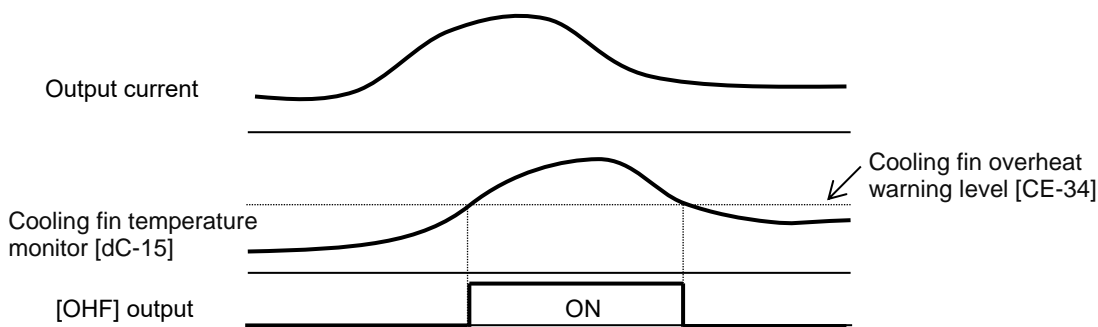

■ Parameters.

Name	Code	Data range (unit)	Description
Output terminal function [11] to [16], [AL]	[CC-01] to [CC-07]	032	[OHF]: Heat sink overheating warning signal [OHF] is output. OFF: Cooling fin temperature monitor [dC-15] is smaller than the Cooling fin overheating warning level [CE-34]. ON: Not above.
Cooling fin overheating warning level	[CE-34]	0 to 200(°C)	Sets the Cooling fin temperature at which the Heat sink overheating warning signal is output. The signal is output when the Cooling fin temperature, it can be monitored at the [dC-15], exceeds this setting.

12.19.11 Outputting a Warning About Electrolytic Capacitors Life-Span on the Circuit Boards



- I want to know the lives of the electrolytic capacitors on the circuit boards before they reach their life spans.



- When a warning about the life of the electrolytic capacitors on the circuit boards occurs, it is recommended to replace the circuit boards.



- Assign the output terminal function 029 [WAC] Capacitor life warning signal to one of [CC-01] to [CC-07] that corresponds to the output terminal and output the signal.
- The life spans of the electrolytic capacitors on the circuit boards are diagnosed from the temperature inside the inverter and the energized time.
- The state of this signal can be monitored by using the life diagnostic monitor. Refer to 13.12.1 “Checking the Life Monitor.”
- A warning also is displayed in the display icons on the operator keypad.

■ Parameter

Name	Code	Data range (unit)	Description
Output terminal function [11] to [15], [AL]	[CC-01] to [CC-07]	029	[WAC]: The electrolytic capacitors (on the circuit boards) life warning signal [WAC] is output. OFF: No warning. ON: Time to replace the circuit boards because the electrolytic capacitors on the circuit boards have reached their life spans.
Life assessment monitor	[dC-16]	LL to HH	The monitors become H at the end of the life spans. The monitor on the right indicates the lives of the electrolytic capacitors on the circuit boards, whereas that on the left indicates the life of the cooling fan.

12.19.12 Outputting a Warning About the Life of the Cooling Fan



- I want to know the life of the cooling fan before it reaches its life span.



- Assign the output terminal function 030 [WAF] cooling-fan speed drop signal to the [CC-01] to [CC-07] that corresponds to the output terminal and output the signal.
- The signal is output when it is detected that the rotation speed of the cooling fan incorporated in the inverter has decreased to 75% or less.
- The state of this signal can be monitored by using the life diagnostic monitor. Refer to 13.12.1 “Checking the Life Monitor.”
- A warning also is displayed in the display icons on the operator keypad.



- Check the cooling fan for clogging when this signal is output.
- This signal is not output when the fan is stopped by the Cooling fan control method selection [bA-70] setting.

■ Parameters.

Name	Code	Data range (unit)	Description
Output terminal function [11] to [16], [AL]	[CC-01] to [CC-07]	030	[WAF]: The cooling-fan speed drop signal [WAF] is output. OFF: No warning. ON: Fan rotation speed has decreased.
Life assessment monitor	[dC-16]	LL to HH	The monitors become H at the end of the life spans. The monitor on the right indicates the lives of the electrolytic capacitors on the circuit board, whereas that on the left indicates the life of the cooling fan.

12.19.13 Outputting a Warning Based on the Accumulated RUN Time Hours



- I want to know when the accumulated running hours of the inverter is reached a certain period time.
- I want to output with a signal the number of operating hours of the system in which the inverter has been incorporated.



- Assign the output terminal function 024 [RNT] Accumulated operation time over signal to the [CC-01] to [CC-07] that corresponds to the output terminal and output the signal.
- Specify the accum. RUN time (RNT) / Accum. Power-ON(ONT) time setting [CE-36].
- The Accumulated operation time over signal [RNT] is output when the accumulative total of inverter power on hours exceeds the time set to the Accum. RUN time (RNT) / Accum. Power-ON (ONT) time setting [CE-36].



- When specifying the time level as a guideline for replacement, use a number with an adequate margin.

■ Setting example.

First time:

If you want to generate a warning when the inverter running time reaches [250 days/year x 8 hours x 5 years =] 10,000 hours, set [CE-36] to 10,000.

Second time onward:

If you want to generate a warning again when the inverter running time reaches [250 days/year x 8 hours x 3 years =] 6,000 hours after the first time above, set [CE-36] to 10,000+6,000=16,000.

■ Parameters.

Name	Code	Data range (unit)	Description
Output terminal function selection [11] to [16], [AL]	[CC-01] to [CC-07]	024	[RNT]: The accumulated operation time over signal [RNT] is output. OFF: Less than the RUN time setting. ON: More than or equal to the RUN time setting.
Accum. RUN time (RNT) / Accum. Power-ON(ONT) time setting	[CE-36]	0 to 100000 (hr)	This function does not work when this setting is 0. Sets 1 to 100,000 hours.
Accumulated RUN time monitor	[dC-22]	0 to 1000000 (hr)	The accumulated time of the inverter running hours is stored and monitored.

12.19.14 Outputting a Warning Based on the Accumulated Power-On Hours



- I want to know when the number of power-on hours reaches a certain period of time.
- I want to output with a signal the number of operating hours of the system in which the inverter has been incorporated.



- When specifying the time level as a guideline for replacement, use a number with an adequate margin.



- Assign the output terminal function 025 [ONT] Accumulated power-on time over signal to one of [CC-01] to [CC-07] that corresponds to the output terminal and output the signal.
- Specify the Accum. RUN time (RNT) / Accum. Power-ON(ONT) time setting [CE-36].
- The Accumulated operation time over signal [RNT] is output when the accumulative total of inverter power-on hours exceeds the time set to the Accum. RUN time (RNT)/Accum. Power-ON (ONT) time setting [CE-36].

■ Setting example.

If you want to generate a warning when power-on time of the inverter reaches [300 days/year x 24 hours x 3 years =] 21,600 hours, set [CE-36] to 21,600.

Second time onward:

If you want to generate a warning again when power-on time of the inverter reaches [250 days/year x 8 hours x 5 years =] 10,000 hours after the first time above, set [CE-36] to 21600+10000=31,600.

■ Parameters.

Name	Code	Data range (unit)	Description
Output terminal function [11] to [15], [AL]	[CC-01] to [CC-07]	025	[ONT]: The accumulated power-on time over [ONT] is output. OFF: Less than the power-on time setting. ON: More than or equal to the power-on time setting.
Accum. RUN time (RNT) / Accum. Power-ON(ONT) time setting	[CE-36]	0 to 100000 (hr)	This function does not work when this setting is 0. Sets 1 to 100,000 hours.
Accumulated power-on time monitor	[dC-24]	0 to 1000000 (hr)	The accumulated time of power-on hours of the inverter is stored and monitored.

12.19.15 Outputting a Warning When the Power Supply Voltage Is High



- I want to generate a warning when the power supply voltage is high.



- This function performs detection only when the inverter is stopped. This function does not work while the inverter is in running.



- Assign the output terminal function 081 [OVS] Over-Voltage power Supply signal to the [CC-01] to [CC-17] that corresponds to the output terminal and output the signal.
- The Over-Voltage power Supply signal [OVS] turns on when the main circuit DC bus voltage (P-N voltage) exceeds the power supply overvoltage level setting [bb-62] for 100 s continuously.
- When power supply overvoltage selection [bb-61] is set to 00, only the [OVS] signal is output.
- When power supply overvoltage selection [bb-61] is set to 01, the [OVS] signal is output, and the inverter trips with the Power supply overvoltage error [E015].

■ Parameter

Name	Code	Data range (unit)	Description
Output terminal function selection [11] to [16], [AL]	[CC-01] to [CC-07]	081	[OVS]: The [OVS] signal is output when the power supply voltage is high. OFF: Less than or equal to the power supply overvoltage level. ON: More than the power supply overvoltage level.
Power supply overvoltage selection	[bb-61]	00	Only the [OVS] signal is output.
		01	The [OVS] signal is output, and the inverter trips with the Power supply overvoltage error [E015].
Power supply overvoltage level setting	[bb-62]	(200 V class) 300.0 VDC to 410.0 VDC (400 V class) 600.0 VDC to 820.0 VDC	Sets the power supply overvoltage level.

12.20 How to Output Running Status Related Signals

12.20.1 Outputting a Running Signal



- I want to detect the running status of the inverter and notify the system.



- Assign the output terminal function 001 [RUN] Running signal to the [CC-01] to [CC-07] that corresponds to the output terminal and output the signal.



- The [RUN] signal is turned ON not only when the motor is driven normally, but also when the voltage is output to the motor due to functions such as DC braking or etc.
- The [RUN] signal is turned off when no voltage is output to the motor, such as retry waiting time, DC braking delay time or etc.

■ The timing chart is as follows.

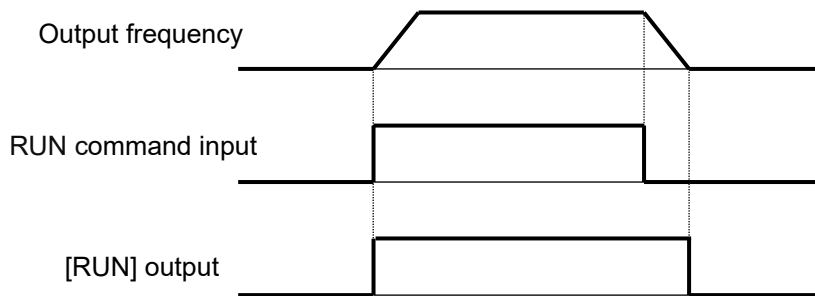

■ Parameter.

Name	Code	Data range (unit)	Description
Output terminal function [11] to [16], [AL]	[CC-01] to [CC-07]	001	[RUN]: The Running signal is output to the output terminal assigned.

12.20.2 Outputting the Forward or Reverse Running Signals



- I want to detect the forward rotation running status of the inverter and notify the system.
- I want to detect the reverse rotation running status of the inverter and notify the system.



- [FWR] and [RVR] is not output during DC breaking or Servo lock.



- Assign the output terminal function 008 [FWR] Forward rotation signal to the [CC-01] to [CC-07] that corresponds to the output terminal and output the signal.
- The [FWR] signal is output only during the inverter is in forward rotation running.
- The timing chart is as follows.

- Assign the output terminal function 009 [RVR] Reverse rotation signal to the [CC-01] to [CC-07] that corresponds to the output terminal and output the signal.
- The [RVR] signal is output only during the inverter is in reverse rotation running.
- The timing chart is as follows.

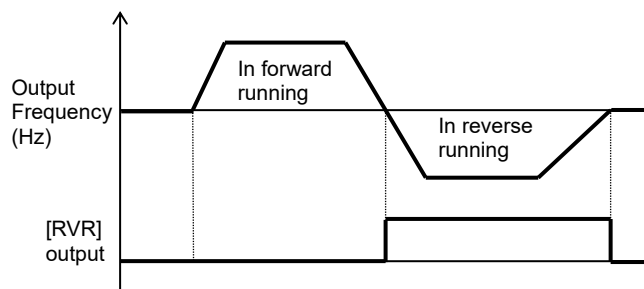
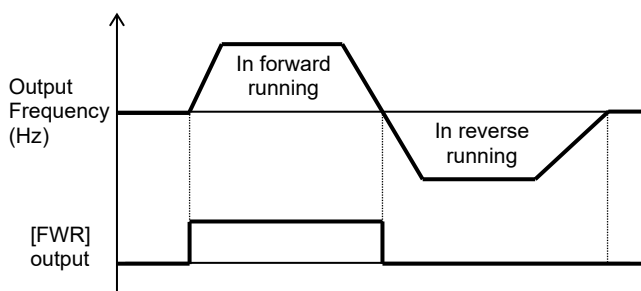

■ Parameter.

Name	Code	Data range (unit)	Description
Output terminal function [11] to [16], [AL]	[CC-01] to [CC-07]	008	[FWR]: The Forward rotation signal is output to the output terminal assigned.
		009	[RVR]: The Reverse rotation signal is output to the output terminal assigned.

12.20.3 Outputting a RUN Command Active Signal

Q

- I want to detect that a RUN command is input to the inverter and notify the system.

A

- Assign the output terminal function 031 [FR] RUN command active to the [CC-01] to [CC-07] that corresponds to the output terminal and output the signal.
- The [FR] signal is output while the inverter accepts RUN commands.
- The [FR] signal is output according to the reception status of the RUN commands even if the RUN command source is other than the [FW]/[RV] input terminal functions.



- When the inverter is in running state by the input terminals, if the 001 [FW] Forward rotation and the 002 [RV] Reverse rotation are input at the same time, a command conflict occurs and it is as a stop command. In this case, the [FR] signal is not output.
- The [FR] signal is turned ON not only when the motor is driven normally, but also when the voltage is output to the motor due to functions such as DC braking or etc.
- When the 101 [REN] RUN enable signal is assigned and OFF, the inverter cannot be run. In this case, the [FR] signal is turned OFF.

- (Example) In the case of [FW]/[RV] input terminal RUN commands.

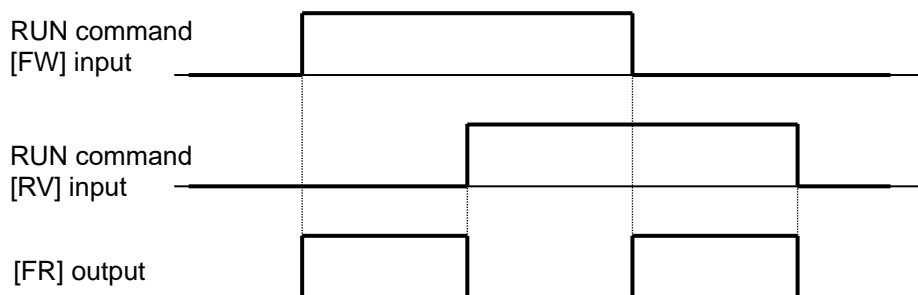

- Parameter.

Name	Code	Data range (unit)	Description
Output terminal function [11] to [16], [AL]	[CC-01] to [CC-07]	031	[FR]: The RUN command active is output to the output terminal assigned.

12.20.4 Outputting a Ready for Run Signal



- I want to notify the system when the inverter can be run with a RUN command.



- Assign the output terminal function 007 [IRDY] Inverter ready signal to the [CC-01] to [CC-07] that corresponds to the output terminal and output the signal.
- The [IRDY] signal is output when the inverter is ready to accept RUN commands.



- When the [IRDY] signal is turned off, the inverter cannot be run even if RUN commands are input.
- The [IRDY] signal is turned off when the voltage cannot be output to the motor, such as during preparation for starting when the power supply is turned on, during under voltage of the main power supply (R,S,T), the inverter is in trip or free-run state, or etc.

■ (Example) In the case of a terminal command.

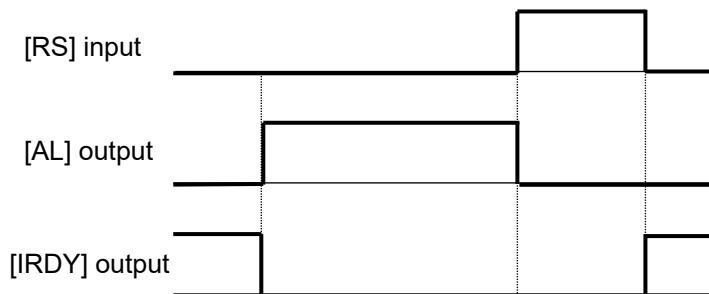

■ Parameter.

Name	Code	Data range (unit)	Description
Output terminal function [11] to [16], [AL]	[CC-01] to [CC-07]	007	[IRDY]: Inverter ready signal is output to the output terminal assigned.

12.21 How to Output the Output Frequency Specific Condition Signals

12.21.1 Outputting an Output Frequency Reference Reached Signal



- I want to detect that the output frequency to the motor is reached the frequency reference and notify the system.



- When the frequency reference input source is analog input, the [FA1] signal may become unstable because the frequency reference fluctuates finely. In this case, it may be improved by adjusting the output terminal on-delay / off-delay time of [CC-20] to [CC-33].



- Assign the output terminal function 002 [FA1] Constant-frequency reached signal to the [CC-01] to [CC-07] that corresponds to the output terminal and output the signal.
- The signal is output when the output frequency is reached the frequency reference.

■ Operation example.

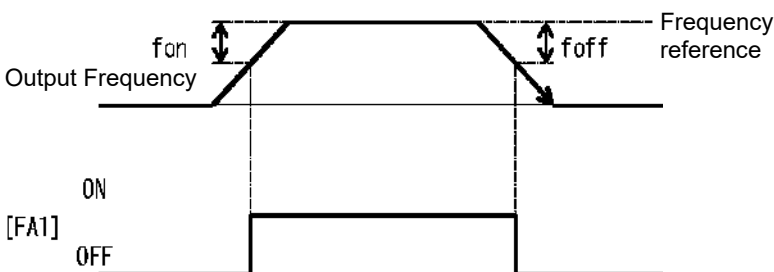

fon: 1% of the maximum frequency
foff: 2% of the maximum frequency

(Operation example)

Maximum frequency: 60 Hz

Set frequency: 50 Hz

• $f_{on} = 60 \times 0.01 = 0.6$ Hz

• $f_{off} = 60 \times 0.02 = 1.2$ Hz

• In acceleration: On at $50 - 0.6 = 49.4$ Hz

• In deceleration: Off at $50 - 1.2 = 48.8$ Hz

■ Parameter.

Name	Code	Data range (unit)	Description
Output terminal function [11] to [16], [AL]	[CC-01] to [CC-07]	002	[FA1]:The constant-frequency reached signal is output to the output terminal assigned.

12.21.2 Outputting the Output Frequency Target Exceeded Signals



- I want to detect that the output frequency to the motor is exceeded the frequency reference and notify the system.



- The [FA2] operating frequencies are set by [CE-10] and [CE-11].
- The [FA4] operating frequencies are set by [CE-12] and [CE-13]



- Assign the output terminal functions 003 [FA2] and 005 [FA4] Set frequency overreached 1/2 signal to the [CC-01] to [CC-07] that corresponds to the output terminal and output the signals.
- The frequencies for ON and OFF of the [FA2] and [FA4] output terminal functions can be set individually.
- The [FA2] and [FA4] signals are turned on when the output frequency exceeds the set frequencies.

■ Operation example.

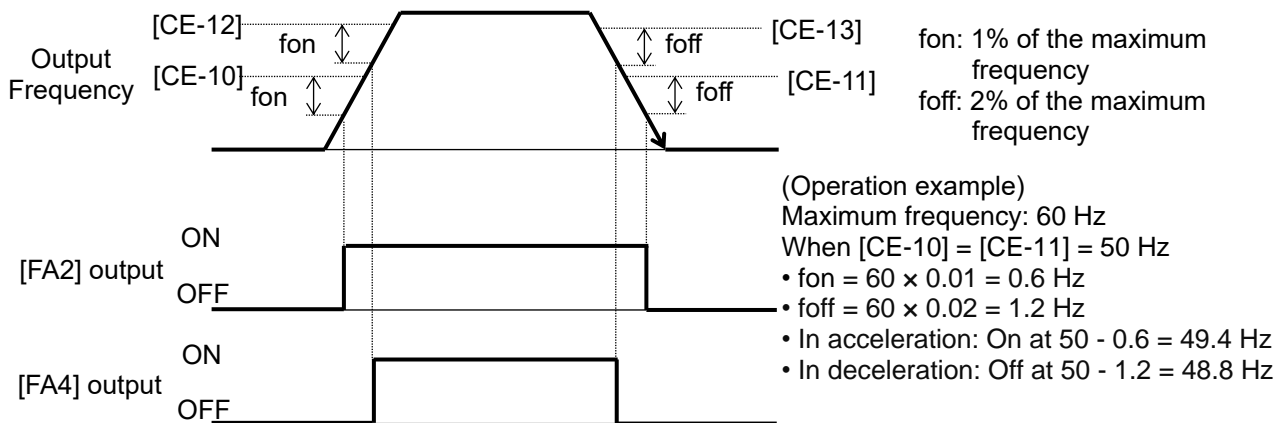

■ Parameter.

Name	Code	Data range (unit)	Description
Output terminal function [11] to [16], [AL]	[CC-01] to [CC-07]	003 005	003 [FA2]: The set frequency overreached signal is output to the output terminal assigned. 005[FA4]:The set frequency overreached 2 signal is output to the output terminal assigned.
Arrival frequency 1 value setting during acceleration	[CE-10]	0.00 to 590.00(Hz)	Sets the frequency to turn on the [FA2] signal by judging that the output frequency is exceeded this setting in acceleration.
Arrival frequency 1 value setting during deceleration	[CE-11]	0.00 to 590.00(Hz)	Sets the frequency to turn off the [FA2] signal by judging that the output frequency is fallen below this setting in deceleration.
Arrival frequency 2 value setting during acceleration	[CE-12]	0.00 to 590.00(Hz)	Sets the frequency to turn on the [FA4] signal by judging that the output frequency is exceeded this setting in acceleration.
Arrival frequency 2 value setting during deceleration	[CE-13]	0.00 to 590.00(Hz)	Sets the frequency to turn off the [FA4] signal by judging that the output frequency is fallen below this setting in deceleration.

12.21.3 Outputting the Output Frequency Target Reached Signals



- I want to detect that the output frequency to the motor has reached around the set value and make a notification to the system.



- The operation of [FA3] can be set through [CE-10] and [CE-11].
- The operation of [FA5] can be set through [CE-12] and [CE-13].



- Assign the output terminal functions 004 [FA3] and 006 [FA5] Set frequency reached signals to one of [CC-01] to [CC-07] that corresponds to the output terminal and output the signals.
- The signals [FA3] and [FA5] can be output individually.
- The signals [FA3] and [FA5] will be output when the enabled output frequency reaches around the setting value.

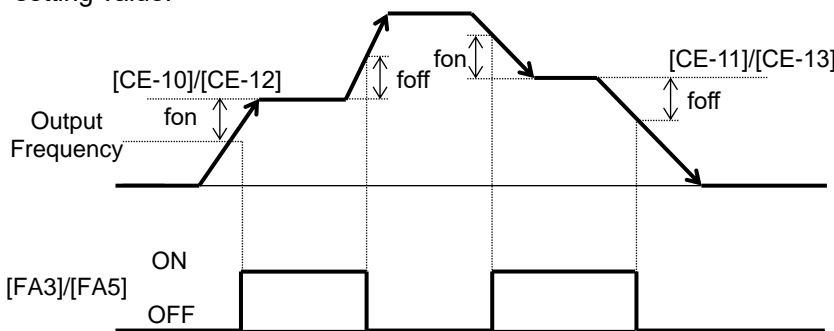

fon: 1% of the maximum frequency
foff: 2% of the maximum frequency

(Operation example)
Maximum frequency: 60 Hz
When [CE-10] = [CE-11] = 50 Hz
• fon=60×0.01=0.6Hz
• foff=60×0.02=1.2Hz
• In acceleration: On at 50 - 0.6 = 49.4 Hz
Off at 50 + 1.2 = 51.2 Hz
• In deceleration: On at 50 + 0.6 = 50.6 Hz
Off at 50 - 1.2 = 48.8 Hz

■ Parameter

Name	Code	Data range (unit)	Description
Output terminal function [11] to [16], [AL]	[CC-01] to [CC-07]	004 006	[FA3]: The set frequency reached signal will be output to the output terminal assigned. [FA5]: The set frequency reached 2 signal will be output to the output terminal assigned.
Arrival frequency 1 value setting during acceleration	[CE-10]	0.00 to 590.00(Hz)	The frequency to judge that the frequency has been reached in acceleration and output the signal [FA3].
Arrival frequency 1 value setting during deceleration	[CE-11]	0.00 to 590.00(Hz)	The frequency to judge that the frequency has been reached in deceleration and output the signal [FA3].
Arrival frequency 2 value setting during acceleration	[CE-12]	0.00 to 590.00(Hz)	The frequency to judge that the frequency has been reached in acceleration and output the signal [FA5].
Arrival frequency 2 value setting during deceleration	[CE-13]	0.00 to 590.00(Hz)	The frequency to judge that the frequency has been reached in deceleration and output the signal [FA5].

12.21.4 Outputting an Output Frequency
0 Hz Reached Signal



- I want to detect that the output frequency to the motor has reached around 0 Hz and make a notification to the system.



- While the operation is stopped, the [ZS] signal becomes ON state because the frequency is 0 Hz.



- Assign the output terminal function 040 [ZS] Zero speed detection signal to one of [CC-01] to [CC-07] that corresponds to the output terminal and output the signal.
- This function is to output a signal when the output frequency of the inverter becomes lower than the level specified with the Zero speed detection level [CE-33].
- When the feedback circuit board is used, the actual frequency of the motor is evaluated for outputting the signal.

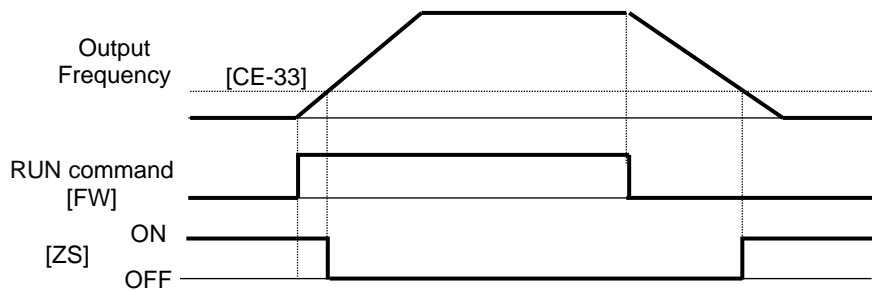

■ Parameter

Name	Code	Data range (unit)	Description
Output terminal function [11] to [16], [AL]	[CC-01] to [CC-07]	040	[ZS]: The Zero speed detection signal is output to the output terminal assigned.
Zero speed detection level	[CE-33]	0.00 to 100.00(Hz)	The frequency setting value to estimate 0-Hz state when [ZS] is output.

12.22 How to detect Analog Inputs Disconnection or Out-of-Range

12.22.1 Disconnection or Out-of-Range Signals of Analog Input Terminals on the Main Unit

Q

- I want to know if the analog input value is within the specified range.
- I want to maintain a constant speed even if a disconnection or short circuit occurs in the analog input wiring.

A

- The [WCAi1]/[WCAi2]/[WCAi3] window comparator signals is output when the analog inputs [Ai1]/[Ai2]/[Ai3] are within the range from the lower limit level setting to the higher limit level setting. Any value can be set for the analog input disconnection detection level.
- Set the output terminal function 056[WCAi1]/057[WCAi2]/058[WCAi3] window comparator signals to any of the output terminal function selection [CC-01] to [CC-07] and output the signals.
- The detection level and hysteresis width can be set individually for each analog input [Ai1]/[Ai2]/[Ai3].

!

- When the [WCAi1], [WCAi2], or [WCAi3] signal is output, the value adopted to the analog input can be fixed to any value by the [Ai1]/[Ai2]/[Ai3] Operation set level at disconnection or compare event [CE-50]/[CE-52]/[CE-54].
- When the analog command holding 019 [AHD] is enabled, the input being held has higher priority.

- Output terminal function [Ai1Dc]/[Ai2Dc]/[Ai3Dc] analog disconnection detection signal can be output by setting the Operation set level implement timing [CE-51]/[CE-53]/[CE-55] to 01 or 02.
- Set the output terminal function 050[Ai1Dc]/051[Ai2Dc]/052[Ai3Dc] analog disconnection signals to any of the output terminal function selection [CC-01] to [CC-07] and output the signals.

Parameter.

Name	Code	Data range (unit)	Description
Output terminal function selection [11] to [16], [AL]	[CC-01] to [CC-07]	050 051 052	The signals 050 [Ai1Dc], 051 [Ai2Dc], and 052 [Ai3Dc] are output to the output terminal assigned.
Output terminal function selection [11] to [16], [AL]	[CC-01] to [CC-07]	056 057 058	The signals 056 [WCAi1], 057 [WCAi2], and 058 [WCAi3] are output to the output terminal assigned.
[Ai1]/[Ai2]/[Ai3] Window comparator higher limit	Ai1:[CE-40] Ai2:[CE-43]	0 to 100(%)	Sets the higher limit for each analog input. The setting ranges are limited to the lower limits level or larger.
	Ai3:[CE-46]	-100 to 100(%)	
[Ai1]/[Ai2]/[Ai3] Window comparator lower limit	Ai1:[CE-41] Ai2:[CE-44]	0 to 100(%)	Sets the lower limit for each analog input. The setting ranges are limited to the higher limit or smaller.
	Ai3:[CE-47]	-100 to 100(%)	
[Ai1]/[Ai2]/[Ai3] Window comparator hysteresis width	Ai1:[CE-42] Ai2:[CE-45] Ai3:[CE-48]	0 to 10(%)	The maxim hysteresis widths are limited to (higher limit level - lower limit level) / 2.
[Ai1]/[Ai2]/[Ai3] Operation set level at disconnection or compare event	Ai1:[CE-50] Ai2:[CE-52]	0 to 100(%)	Sets fixed input value when it is determined that the analog input is in the abnormal range.
	Ai3:[CE-54]	-100 to 100(%)	
[Ai1]/[Ai2]/[Ai3] Operation set level implement timing	Ai1:[CE-51] Ai2:[CE-53] Ai3:[CE-55]	00	Disabled.
		01	Enabled: The window comparator signal is ON when the analog input value is within the higher and lower limit range.
		02	Enabled: The window comparator signal is ON when the analog input value is out of the higher and lower limit range.

■ Window comparator operation.

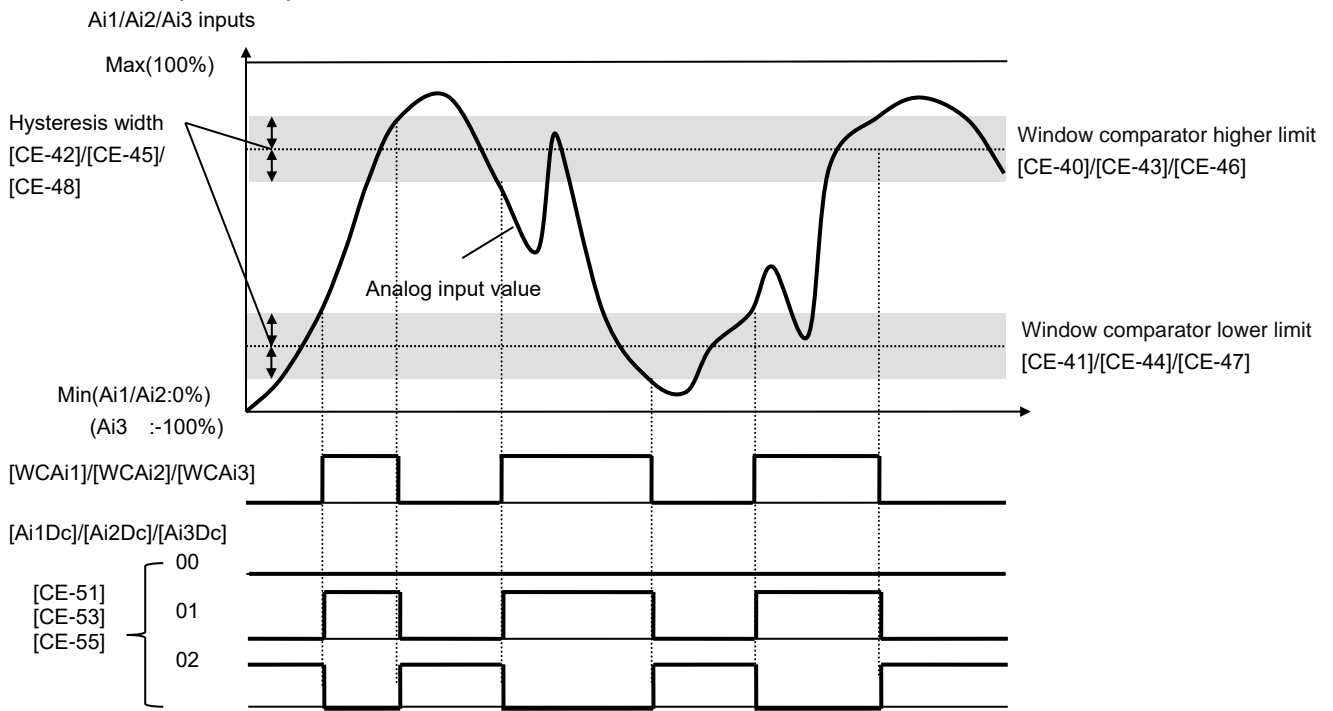

A

- In the window comparator function, the signal is output when the input level is within the specified range.
- In the disconnection detection function, the signal is output when the input level is out of the specified range.
- The logic of the output signals can be inverted from [CC-11] to [CC-17].
- Set the analog operating level so that the input level is fixed when the analog input becomes the maximum value because of a short circuit or when the analog input becomes 0 VDC because of a disconnection.
- To prevent the signal from being output at power-on, set the Output terminal on-delay time of [CC-20] to [CC-32].

■ Output operation in abnormal conditions.
Example when [CE-51]/[CE-53]/[CE-55] = 02.

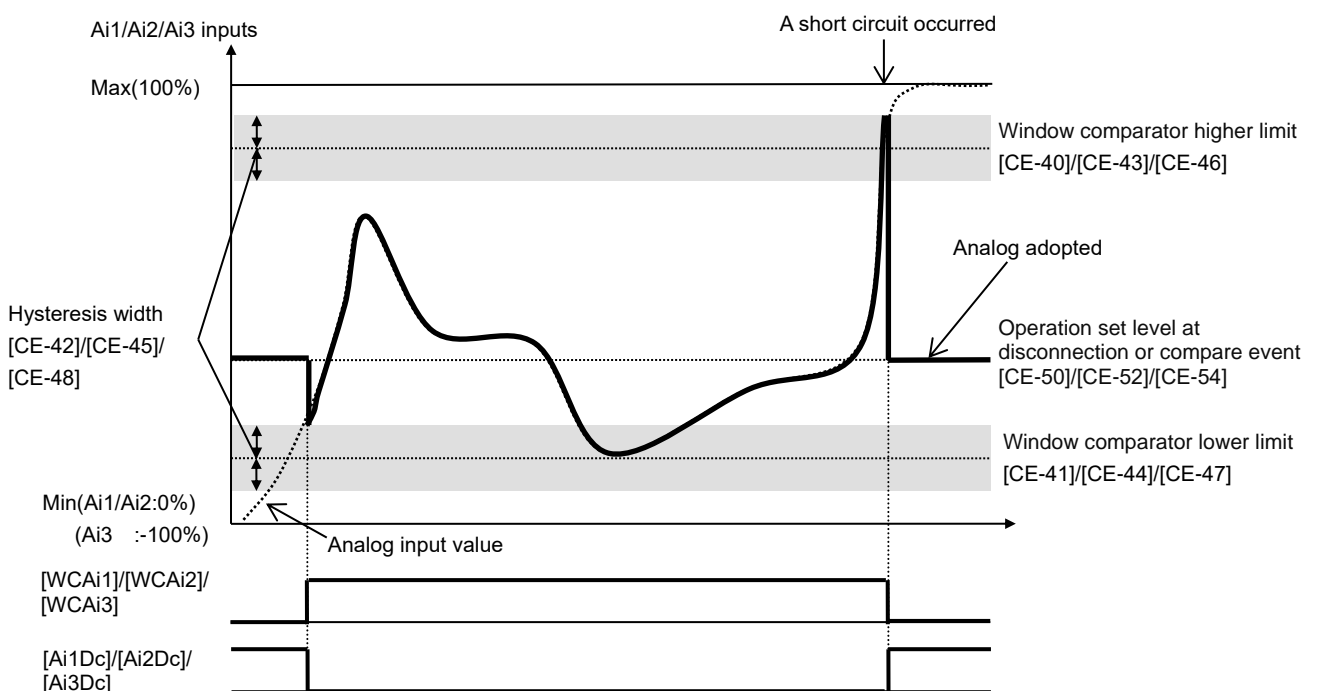

- Output operation in abnormal conditions.
Example when [CE-51]/[CE-53]/[CE-55] = 01.

- When the analog input becomes the minimum value (Min) because of a disconnection in the input wire.

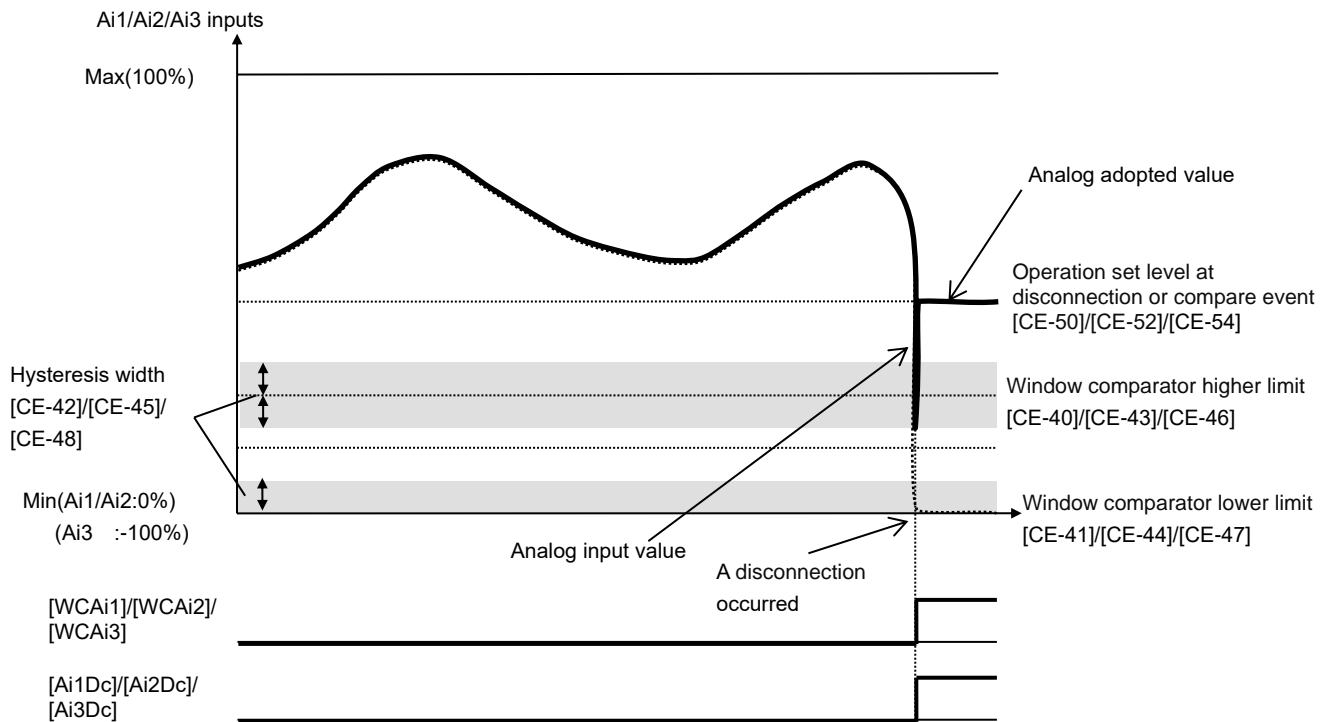

- When the analog input becomes the maximum value (Max) because of a short circuit in the input wire.

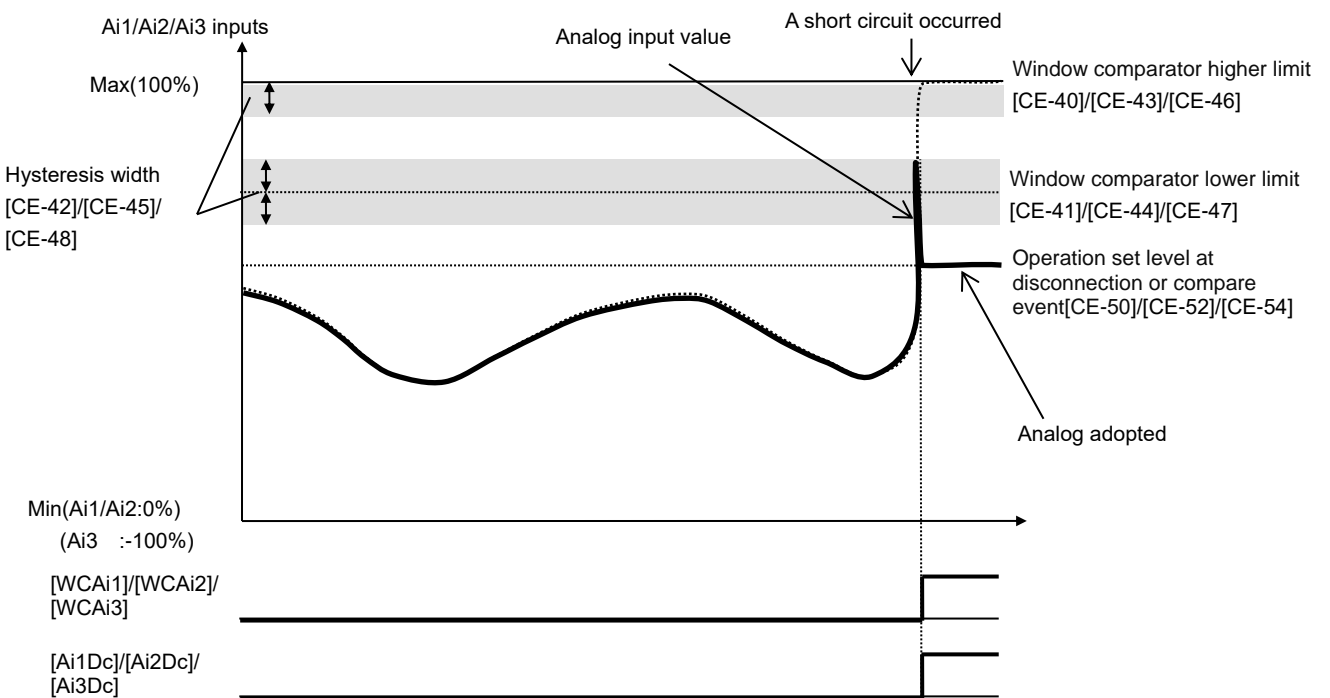

12.22.2 Disconnection or Out-of-Range Signals of Analog Input Terminals on the P1-AG Option

Q

- I want to know if the analog input value is within the specified range when the P1-AG option is used.
- I want to maintain a constant speed even if a disconnection or short circuit occurs in the analog input wiring of the P1-AG option.

!

- When the [WCAi4], [WCAi5], or [WCAi6] signal is output, the value adopted to the analog input can be fixed to any value by the [Ai4]/[Ai5]/[Ai6] Temporal operation level set at disconnection or compare event [oE-44]/[oE-46]/[oE-48].
- When the analog command holding 019 [AHD] is enabled, the input being held has higher priority.

A

- The [WCAi4]/[WCAi5]/[WCAi6] window comparator signals is output when the analog inputs [Ai4]/[Ai5]/[Ai6] are within the range from the lower limit level setting to the higher limit level setting. Any value can be set for the analog input disconnection detection level.
- Set the output terminal function 059[WCAi4]/060[WCAi5]/061[WCAi6] window comparator signals to any of the output terminal function selection [CC-01] to [CC-07] and output the signals.
- The detection level and hysteresis width can be set individually for each analog input [Ai4]/[Ai5]/[Ai6].
- Output terminal function [Ai4Dc]/[Ai5Dc]/[Ai6Dc] analog disconnection detection signal can be output by setting the Temporal operation level implementation timing [oE-45]/[oE-47]/[oE-49] to 01 or 02.
- Set the output terminal function 053[Ai4Dc]/054[Ai5Dc]/055[Ai6Dc] analog disconnection signals to any of the output terminal function selection [CC-01] to [CC-07] and output the signals.
- See also the P1-AG Analog Input / Output Option User's Guide.

Parameter.

Name	Code	Data range (unit)	Description
Output terminal function selection [11] to [16], [AL]	[CC-01] to [CC-07]	053 054 055	The signals 053 [Ai4Dc], 054 [Ai5Dc], and 055 [Ai6Dc] is output to the output terminal assigned.
Output terminal function selection [11] to [16], [AL]	[CC-01] to [CC-07]	059 060 061	The signals 059 [WCAi4], 060 [WCAi5], and 061 [WCAi6] are output to the output terminal assigned.
[Ai4]/[Ai5]/[Ai6] Window comparator upper limit	Ai4:[oE-35] Ai5:[oE-38]	0 to 100(%)	Sets the upper limit for each analog input. The setting ranges are limited to the lower limits or larger.
	Ai6:[oE-41]	-100 to 100(%)	
[Ai4]/[Ai5]/[Ai6] Window comparator lower limit	Ai4:[oE-36] Ai5:[oE-39]	0 to 100(%)	Sets the lower limit for each analog input. The setting ranges are limited to the upper limits or smaller.
	Ai6:[oE-42]	-100 to 100(%)	
[Ai4]/[Ai5]/[Ai6] Window comparator hysteresis width	Ai4:[oE-37] Ai5:[oE-40] Ai6:[oE-43]	0 to 10(%)	The maxim hysteresis widths are limited to (upper limit level - lower limit level)/2.
[Ai4]/[Ai5]/[Ai6] Temporal operation level set at disconnection or compare event	Ai4:[oE-44] Ai5:[oE-46]	0 to 100(%)	Sets fixed input value when it is determined that the analog input is in the abnormal range.
	Ai6:[oE-48]	-100 to 100(%)	
[Ai4]/[Ai5]/[Ai6] Temporal operation level implementation timing	Ai4:[oE-45] Ai5:[oE-47] Ai6:[oE-49]	00	Disabled.
		01	Enabled: The window comparator signal is ON when the analog input value is within the upper and lower limit range.
		02	Enabled: The window comparator signal is ON when the analog input value is out of the upper and lower limit range.

■ Window comparator operation.

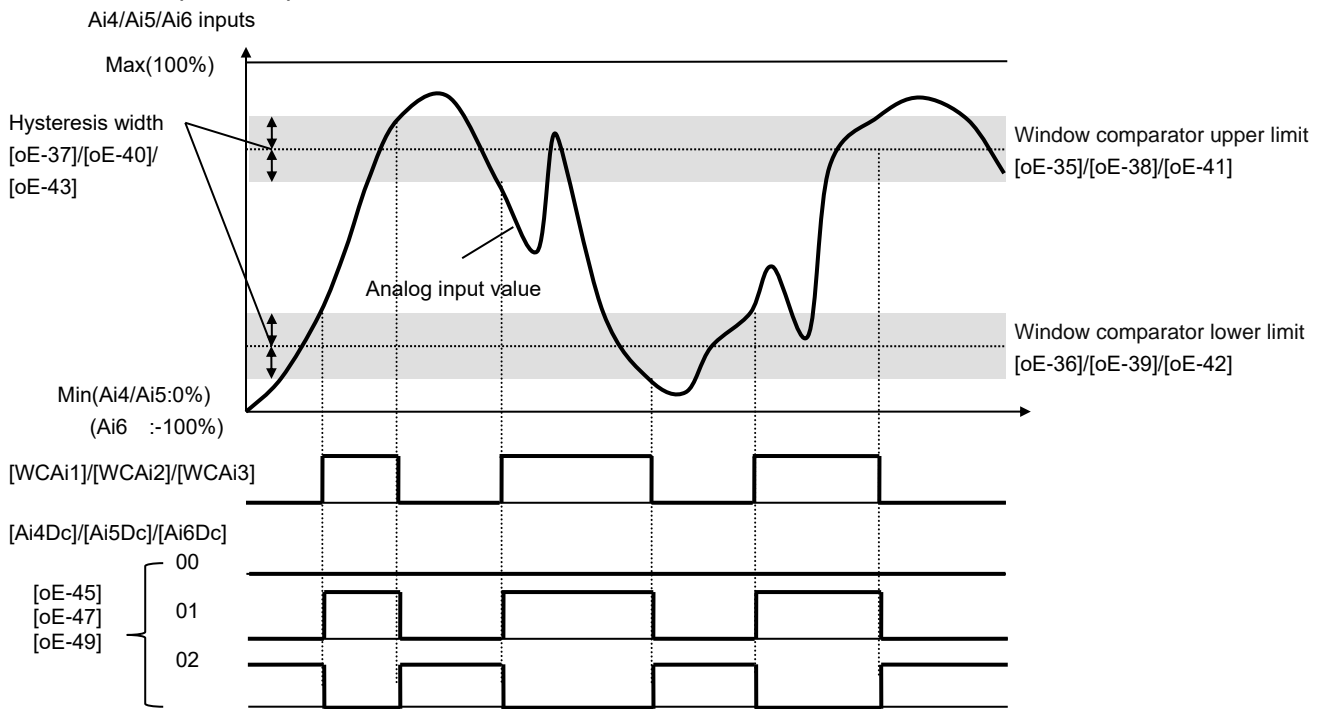

A

- In the window comparator function, the signal is output when the input level is within the specified range.
- In the disconnection detection function, the signal is output when the input level is out of the specified range.
- The logic of the output signals can be inverted from [CC-11] to [CC-17].
- Set the analog operating level so that the input level is fixed when the analog input becomes the maximum value because of a short circuit or when the analog input becomes 0 VDC because of a disconnection.
- To prevent the signal from being output at power-on, set the Output terminal on-delay time of [CC-20] to [CC-32].

■ Output operation in abnormal conditions.

Example when [oE-45]/[oE-47]/[oE-49] = 02.

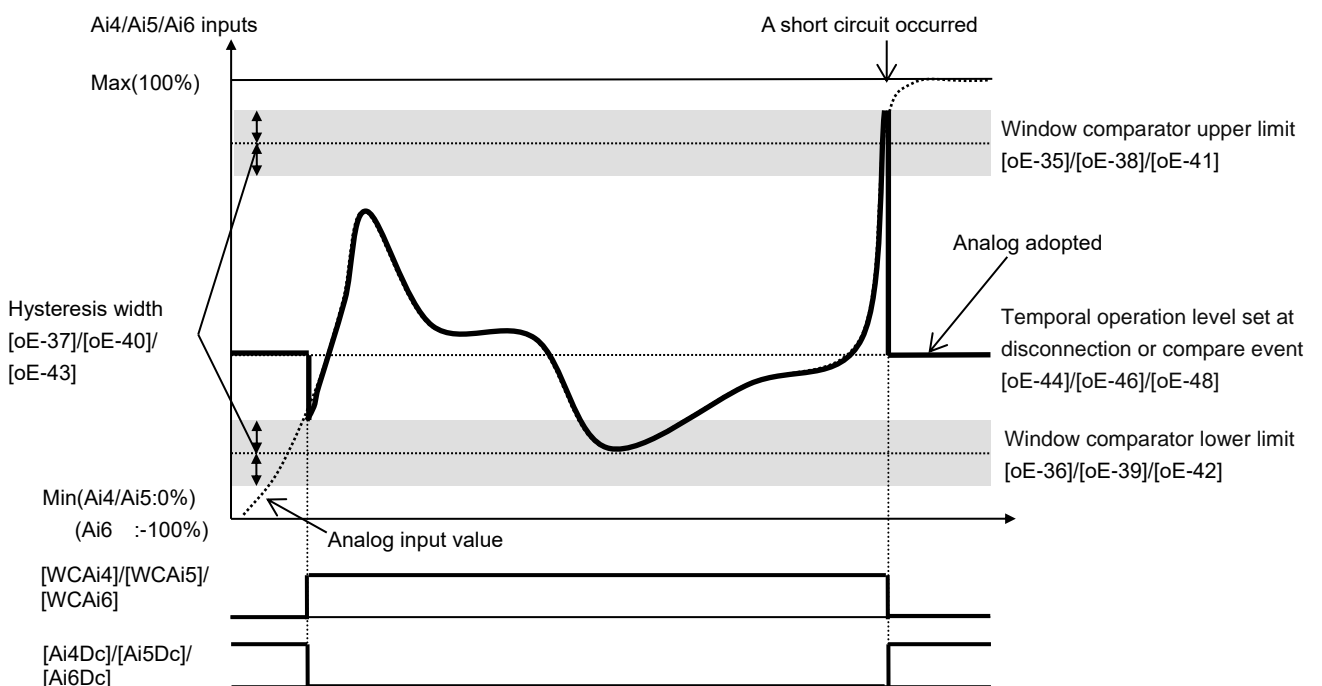

- Output operation in abnormal conditions.
Example when [oE-45]/[oE-47]/[oE-49] = 01

- When the analog input becomes the minimum value (Min) because of a disconnection in the input wire.

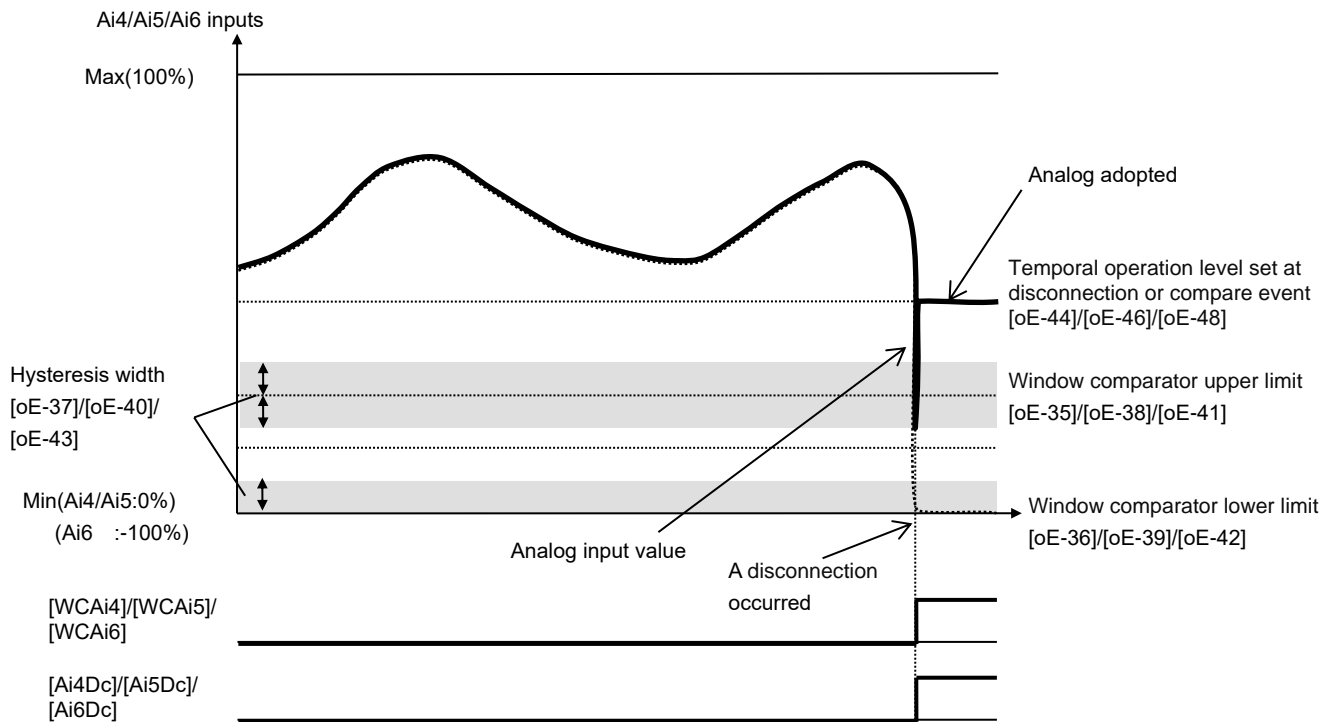

- When the analog input becomes the maximum value (Max) because of a short circuit in the input wire.

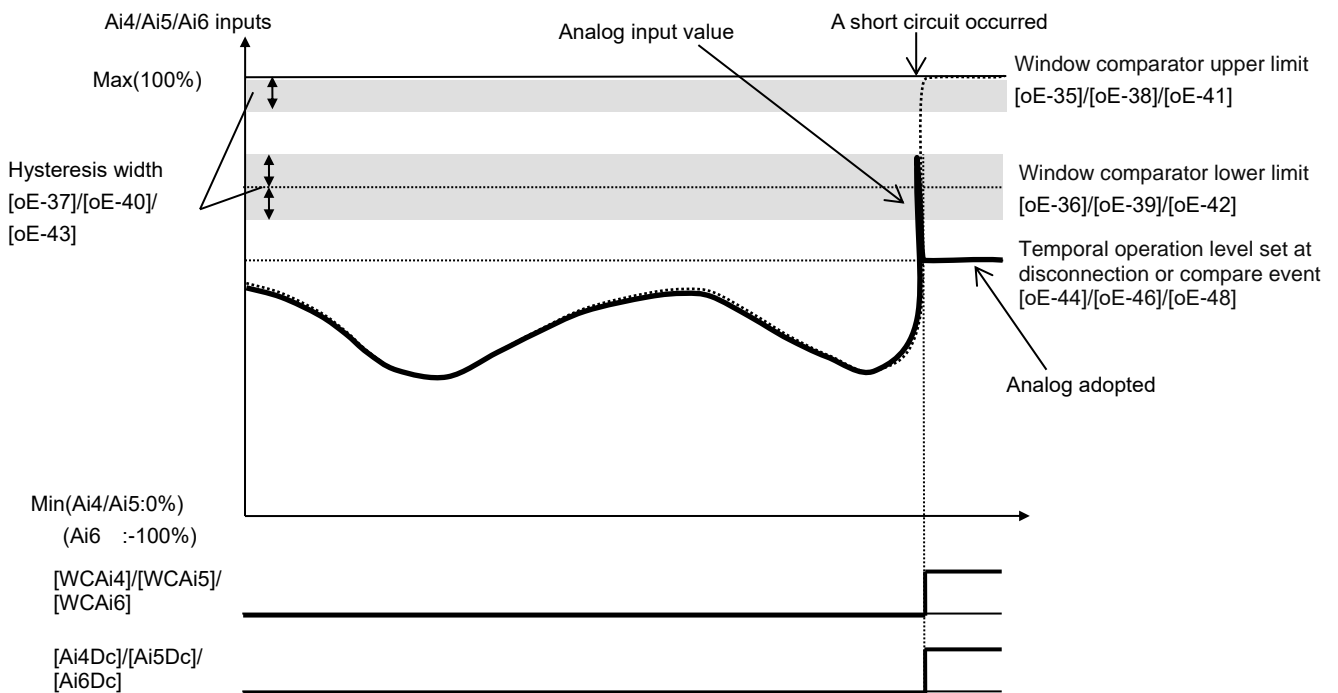

12.23 How to Output the Logical Operation of Two Output Signals



- I want to output one output signal by combining the output terminal functions.



- Except for the logical operation results [LOG1] to [LOG7], all other output terminal functions can be targeted for logical operation.



- Various signals can be output by performing logical operations on the output terminal functions inside the inverter.
- Three types of logical operations, AND, OR, and XOR, can be selected.

Selected signal	parameter	operand-1 selection	operand-2 selection	logical calculation selection
062: Logical operation result 1 (LOG1)		[CC-40]	[CC-41]	[CC-42]
063: Logical operation result 2 (LOG2)		[CC-43]	[CC-44]	[CC-45]
064: Logical operation result 3 (LOG3)		[CC-46]	[CC-47]	[CC-48]
065: Logical operation result 4 (LOG4)		[CC-49]	[CC-50]	[CC-51]
066: Logical operation result 5 (LOG5)		[CC-52]	[CC-53]	[CC-54]
067: Logical operation result 6 (LOG6)		[CC-55]	[CC-56]	[CC-57]
068: Logical operation result 7 (LOG7)		[CC-58]	[CC-59]	[CC-60]

(Example 1) The AND logical operation results of the "003[FA2] Set frequency overreached" and the "033[LOC] Low-current indication" are output to the Output terminal [11].

If the output current drops while the output frequency exceeds the specified frequency, the [LOG1] Logical operation result 1 is turned ON.

- Output terminal [11] function [CC-01]: 062 (LOG1)
- LOG1 operand-1 selection [CC-40]: 003 (FA2)
- LOG1 operand-2 selection [CC-41]: 033 (LOC)
- LOG1 logical calculation selection [CC-42]: 00 (AND)

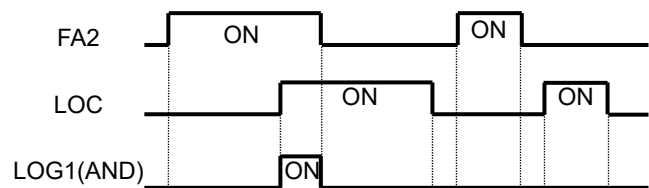

(Example 2) The OR logical operation results of the "035[OL] Overload warning notice" and the "026[THM] Electronic thermal alarm (Motor)" are output to the Output terminal [12].

If the output current becomes larger or smaller than the specified range, the [LOG3] Logical operation result 3 is turned ON.

- Output terminal [12] function [CC-02]: 064 (LOG3)
- LOG3 operand-1 selection [CC-46]: 035 (OL)
- LOG3 operand-2 selection [CC-47]: 026 (THM)
- LOG3 logical calculation selection [CC-48]: 01 (OR)

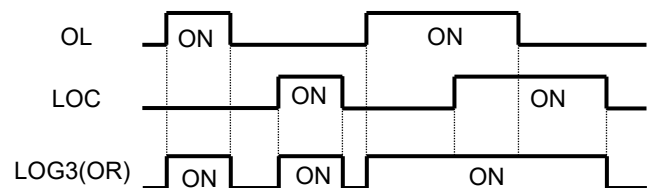

(Example 3) The XOR logical operation results of the “035[OL] Overload warning notice” and the “036[OL2] Overload warning notice 2” are output to the Output terminal [13].

If the output current is within the specified range, the [LOG5] Logical operation result 5 is turned ON.

- Output terminal [13] function [CC-03]: 066 (LOG5)
- LOG5 operand-1 selection [CC-52]: 035 (OL)
- LOG5 operand-2 selection [CC-53]: 036 (OL2)
- LOG5 logical calculation selection [CC-54]: 02 (XOR)

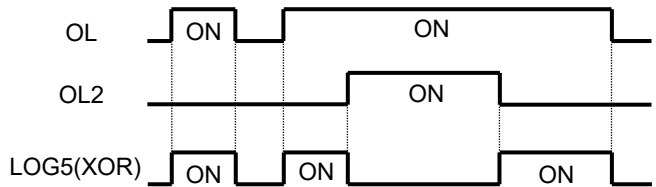

■ Parameters.

Name	Code	Data range (unit)	Description
Output terminal function selection [11] to [16], [AL]	[CC-01] to [CC-07]	062 063 064 065 066 067 068	LOG1 to LOG7: Logical operation result 1 to 7
LOG * operand-1 selection	[CC-40], [CC-43], [CC-46], [CC-49], [CC-52], [CC-55], [CC-58]	Select from the output terminal function selection data (excluding LOG1 to LOG7)	Select Arithmetic operation target 1
LOG * operand-2 selection	[CC-41], [CC-44], [CC-47], [CC-50], [CC-53], [CC-56], [CC-59]	Select from the output terminal function selection data (excluding LOG1 to LOG7)	Select Arithmetic operation target 2
LOG * logical calculation selection	[CC-42], [CC-45], [CC-48], [CC-51], [CC-54], [CC-57], [CC-60]	00	AND
		01	OR
		02	XOR

12.24 Functions with Input Terminal Signal

12.24.1 Intelligent Input Terminal Function Settings

Q

- I want to operate the function by inputting a signal into the inverter.
- I want to make a setting to prevent noise from entering into signals.

A

- Input terminals [1] to [9], [A] and [B] are intelligent input terminals. The each function on the next page can be assigned to each input terminal.
- The pulse train input signal can be assigned to the input terminals [A] and [B].

!

- If you assign the function you want to execute to [CA-01] to [CA-11], the assigned function will be executed when the input terminal is turned ON.
- You can switch a contact for an input signal with the Input terminal [1] to [9], [A], [B] active state [CA-21] to [CA-31].
- When a function is selected for many targets, the targets will be set to “00 [no] Not use”, excluding the finally set function selection.

■ Parameters.

Name	Code	Data range (unit)	Description
Input terminal [1] to [9], [A], [B] function	[CA-01] to [CA-11]	Next page: Table of input terminal selections	Assign the input terminal function to each input terminal.
Input terminal [1] to [9], [A], [B] active state	[CA-21] to [CA-31]	00	Operates as Contact a (NO).
		01	Operates as Contact b (NC).

■ Terminals corresponding to parameters.

Terminal block symbol	Function setting destination parameter
1	[CA-01]
2	[CA-02]
3	[CA-03]
4	[CA-04]
5	[CA-05]
6	[CA-06]
7	[CA-07]
8	[CA-08]
9	[CA-09]
A	[CA-10]
B	[CA-11]

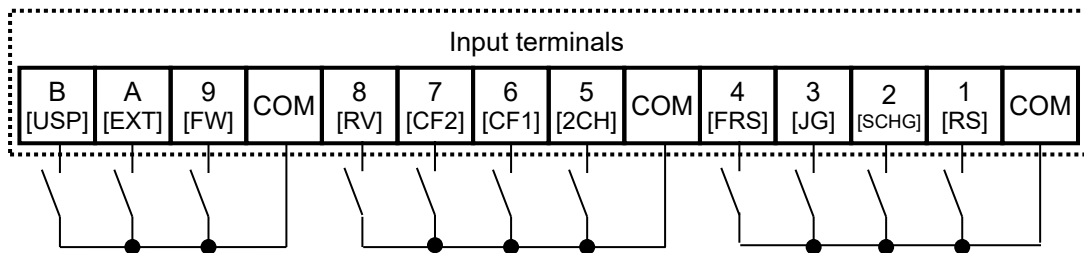

■ Table of the input terminal function list.

No.	Abbreviation	Function name	Page
000	no	Not use	-
001	FW	Forward rotation	12-5-3
002	RV	Reverse rotation	12-5-3
003	CF1	Multi speed selection 1	12-4-13
004	CF2	Multi speed selection 2	12-4-13
005	CF3	Multi speed selection 3	12-4-13
006	CF4	Multi speed selection 4	12-4-13
007	SF1	Multi speed Bit-1	12-4-14
008	SF2	Multi speed Bit-2	12-4-14
009	SF3	Multi speed Bit-3	12-4-14
010	SF4	Multi speed Bit-4	12-4-14
011	SF5	Multi speed Bit-5	12-4-14
012	SF6	Multi speed Bit-6	12-4-14
013	SF7	Multi speed Bit-7	12-4-14
014	ADD	Trigger for frequency addition	12-4-15
015	SCHG	Main/Sub speed reference change	12-4-10
016	STA	3-wire Start	12-5-4
017	STP	3-wire Stop	12-5-4
018	F/R	3-wire Forward/Reverse	12-5-4
019	AHD	analog command holding	12-4-17
020	FUP	Remote control Speed-UP function	12-4-16
021	FDN	Remote control Speed-DOWN function	12-4-16
022	UDC	Remote control Speed data clearing	12-4-16
023	F-OP	Force operation	12-4-18 12-5-7
024	SET	2nd-motor control	12-17-1
028	RS	Reset	12-24-6
029	JG	Jogging	12-17-4
030	DB	External DC braking	12-15-5
031	2CH	2-stage Acceleration/Deceleration	12-8-3
032	FRS	Free run stop	12-14-11 12-15-1
033	EXT	External fault	12-16-3
034	USP	unattended start protection	12-16-4
035	CS	Commercial power supply change	12-17-2
036	SFT	Soft-Lock	9-24
037	BOK	Answer back from Brake	12-17-5
038	OLR	Overload restriction selection	12-13-2
039	KHC	Accumulation input power clearance	13-14
040	OKHC	Accumulation output power clearance	13-15
041	PID	Disable PID1	12-10-13
042	PIDC	PID1 integration reset	12-10-13
043	PID2	Disable PID2	12-10-27
044	PIDC2	PID2 integration reset	12-10-27
045	PID3	Disable PID3	12-10-27
046	PIDC3	PID3 integration reset	12-10-27
047	PID4	Disable PID4	12-10-27
048	PIDC4	PID4 integration reset	12-10-27
051	SVC1	Multi set-point selection 1	12-10-9
052	SVC2	Multi set-point selection 2	12-10-9
053	SVC3	Multi set-point selection 3	12-10-9
054	SVC4	Multi set-point selection 4	12-10-9

No.	Abbreviation	Function name	Page
055	PRO	PID gain change	12-10-14
056	PIO1	PID output switching 1	12-10-22
057	PIO2	PID output switching 2	12-10-22
058	SLEP	SLEEP condition activation	12-10-17
059	WAKE	WAKE condition activation	12-10-17
060	TL	Torque limit enable *1)	12-11-7
061	TRQ1	Torque limit selection bit1 *1)	12-11-7
062	TRQ2	Torque limit selection bit2 *1)	12-11-7
063	PPI	P/PI control mode selection	12-11-2 12-11-5
064	CAS	Control gain change	12-11-2 12-11-5
065	SON	Servo-on	12-17-33
066	FOC	Forcing	12-14-13
067	ATR	Permission of torque control *1)	12-11-13
068	TBS	Torque Bias enable *1)	12-11-11
069	ORT	Home search function	12-17-22
071	LAC	Acceleration/Deceleration cancellation	12-8-11
072	PCLR	Clearance of position deviation	12-17-21 12-17-25
073	STAT	Pulse train position reference input enable	12-17-17
074	PUP	Position bias (ADD)	12-17-21
075	PDN	Position bias (SUB)	12-17-21
076	CP1	Multistage position settings selection 1	12-17-27
077	CP2	Multistage position settings selection 2	12-17-27
078	CP3	Multistage position settings selection 3	12-17-27
079	CP4	Multistage position settings selection 4	12-17-27
080	ORL	Limit signal of Homing function	12-17-29
081	ORG	Start signal of Homing function	12-17-29
082	FOT	Forward Over Travel	12-17-30
083	ROT	Reserve Over Travel	12-17-30
084	SPD	speed / position switching	12-17-27
085	PSET	Position data presetting	12-17-30

*1) These torque related functions are valid when the Control mode selection [AA121] / [AA221] is set to 08(IM-SLV), 09(IM-0Hz-SLV), or 10(IM-CLV).
[ATR] is valid at 08 or 10.

No.	Abbreviation	Function name	Page
086	MI1	General-purpose input 1	16-6
087	MI2	General-purpose input 2	16-6
088	MI3	General-purpose input 3	16-6
089	MI4	General-purpose input 4	16-6
090	MI5	General-purpose input 5	16-6
091	MI6	General-purpose input 6	16-6
092	MI7	General-purpose input 7	16-6
093	MI8	General-purpose input 8	16-6
094	MI9	General-purpose input 9	16-6
095	MI10	General-purpose input 10	16-6
096	MI11	General-purpose input 11	16-6
097	PCC	Pulse counter clearing	12-24-16
098	ECOM	EzCOM activation	14-22
099	PRG	Program RUN	16-6
100	HLD	Acceleration/Deceleration disable	12-8-8
101	REN	RUN enable	12-6-4
102	DISP	Display lock	9-39 12-5-6
103	PLA	Pulse count A	12-9-35 12-24-16
104	PLB	Pulse count B	12-9-35 12-24-16
105	EMF	Emergency-Force Drive activation	12-17-13
107	COK	Contact check signal	12-17-10
108	DTR	Data trace start	16-8
109	PLZ	Pulse train input Z	12-17-22
110	TCH	Teach-in	12-17-28

12.24.2 Changing the Input Signals Logic Level



- I want to input reversed input logic for input signals.
- I want to switch Contacts a/b in the inverter.



- Even when the "Selection of Input terminals a/b" is used, a terminal allocated with a "[RS] Reset terminal" always operates as Contact a (NO).



- You can set input specifications for Contact a or Contact b separately for Input terminals [1] to [9], [A] and [B].

■ Parameters.

Name	Code	Data range (unit)	Description
Input terminal [1] to [9], [A], [B] active state	[CA-21] to [CA-31]	00	Operates as Contact a (NO).
		01	Operates as Contact b (NC).

- Contact a: Closes with "ON," and opens with "OFF."
- Contact b: Closes with "OFF," and opens with "ON."

Input terminal	Switching between Contact a (NO) and Contact b (NC)
1	[CA-21]
2	[CA-22]
3	[CA-23]
4	[CA-24]
5	[CA-25]
6	[CA-26]
7	[CA-27]
8	[CA-28]
9	[CA-29]
A	[CA-30]
B	[CA-31]

12.24.3 Adjusting the Response to Input Signals



- I want to delay the response to an input signal.
- I want to prevent as much as possible a signal from fluctuating.
- Since noise is included in the input signal, I want to make settings to avoid that noise.



- You can set a response time per input terminal.
- For the correspondence between input terminals and parameters, please refer to the table shown on the right.



- All input signals immediately turn ON/OFF upon a condition is satisfied. Chattering could occur depending on a selected signal. This function is available for retaining/delaying such a signal.

Input terminal	Response time
1	[CA-41]
2	[CA-42]
3	[CA-43]
4	[CA-44]
5	[CA-45]
6	[CA-46]
7	[CA-47]
8	[CA-48]
9	[CA-49]
A	[CA-50]
B	[CA-51]

■ Parameters.

Name	Code	Data range (unit)	Description
Input terminal [1] to [9], [A], [B] response time	[CA-41]/[CA-42]/[CA-43]/[CA-44]/[CA-45]/[CA-46]/[CA-47]/[CA-48]/[CA-49]/[CA-50]/[CA-51]	0 to 400(ms)	Sets a response time.

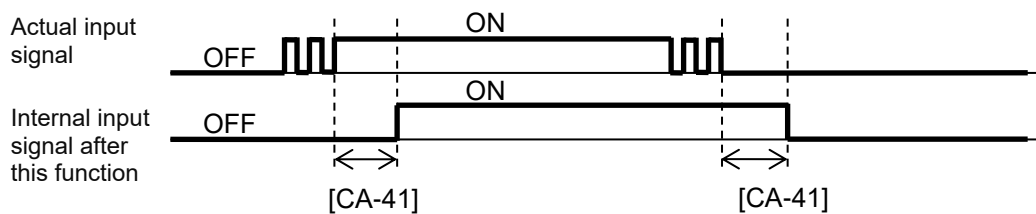

12.24.4 Alarm Resetting

Q

- I want to release the trip of inverter.
- I want to make an "[RS] Reset terminal" valid only when a trip has occurred.

A

- You can release the trip of inverter.
- For resetting, press the Stop/Reset key on the operator keypad or turn on the [RS] Reset terminal.
- To use the reset terminal, allocate the "[RS] Reset" to the input terminal function.
- Regardless of the settings, the reset terminal is set to serve as Contact a (NO).
- With the Reset mode selection [CA-72], you can select a timing for releasing the trip with the RS terminal. You can make the "[RS] Reset terminal" valid only at a timing for releasing the trip in the event of an abnormality.



- Do not use the "[RS] Reset terminal" in order to interrupt the output of the inverter. To interrupt the output of the inverter with a signal input, use the "[FRS] Free run stop terminal" of the input terminal function.
- The internal data of the inverter is not cleared even if a reset signal is input.
- The frequency at shut down for the Restart with active frequency matching function is not cleared even if the reset signal is input during waiting for retry.

■ Parameters.

Name	Code	Data range (unit)	Description
Reset mode selection	[CA-72]	00	At ON, cancels the trip (Example 1 and 3). At normal: Interrupts the output. At abnormal: Cancels the trip.
		01	At OFF, cancels the trip (Example 2 and 3). At normal: Interrupts the output. At abnormal: Cancels the trip.
		02	At ON, cancels the trip (Examples 1 and 4). At normal: Invalid At abnormal: Cancels the trip.
		03	At OFF, cancels the trip (Examples 2 and 4). At normal: Invalid At abnormal: Cancels the trip.
Restart mode after RS release	[bb-41]	00	Restart at 0 Hz
		01	Restart with frequency matching
		02	Restart with active frequency matching
		03	Detect speed *1)
Input terminal function	[CA-01] to [CA-11]	028	RS: Reset function

*1) For frequency matching by detection speed, feedback input to input terminals A and B or feedback input to option P1-FB is required.

■ Parameters (continued).

Name	Code	Data range (unit)	Description
Retry wait time after instantaneous power failure/under-voltage error	[bb-26]	0.3 to 100.0(s)	A stand-by time for restarting after resetting, and after an RUN command has been given
Frequency matching minimum restart frequency	[bb-42]	0.00 to 590.00(Hz)	The lower limit frequency setting for restarting
Active frequency matching restart level	[bb-43]	(0.2 to 2.0) × Inverter rated current (A)	The current limit level when restarting frequency acquisition
Active frequency matching restart constant (speed)	[bb-44]	0.10 to 30.00 (sec)	The deceleration rate at the time of frequency acquisition
Active frequency matching restart constant (voltage)	[bb-45]	0.10 to 30.00 (sec)	The start time of frequency acquisition
OC-suppress level at active frequency matching	[bb-46]	(0.2 to 2.0) × Inverter rated current (A)	The limit current value setting for the excessive current prevention level at the time of frequency acquisition
Active frequency matching restart speed selection	[bb-47]	00	Output frequency at shut down
		01	Maximum frequency
		02	Setting frequency

■ Examples of the Reset operations.

(Example 1) Cancelling the trip at ON ([CA-72]=00,02).

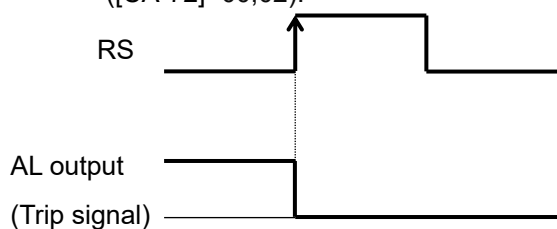

(Example 2) Cancelling the trip at OFF ([CA-72]=01,03).

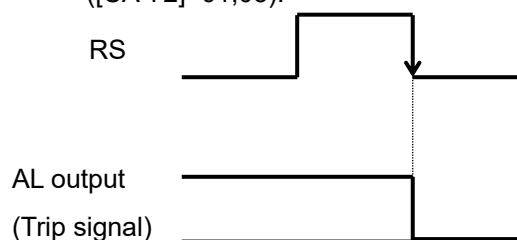

(Example 3) Validating resetting at normal ([CA-72]=00,01),

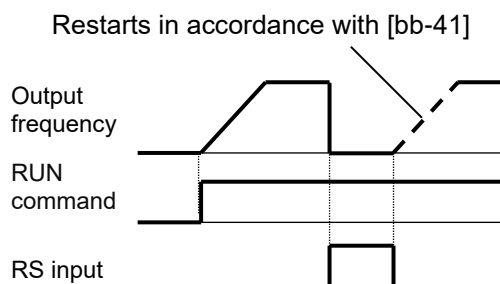

(Example 4) Invalidating resetting at normal ([CA-72]=02,03).

Reset is invalid while the inverter is in running.

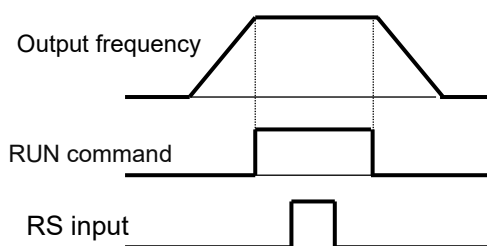

- Examples of restarting when resetting.
 (Example 5) When the "Restarting with frequency matching" is selected ([bb-41]=01).

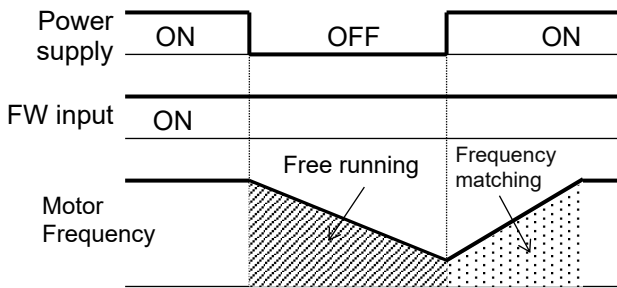

A

- In the Restart mode after RS release [bb-41], when 01 (Restart with frequency matching) or 03 (Detect speed) is selected, restarting with frequency matching is possible when the power supply is turned on again. When 00 (Restarting at 0Hz) is set, the operation starts from 0 Hz without waiting for the Retry wait time after instantaneous power failure/under-voltage error [bb-26].

!

- Even when the Restarting with frequency matching is selected, start-up of the motor may be the Restart at 0 Hz in the following cases:
 - When an output frequency is 1/2 of a base frequency or below.
 - When the induced voltage of the motor quickly attenuates.
 - When the frequency by the frequency matching is less than or equal to the setting of the Frequency matching minimum restart frequency [bb-42].

- (Example 6) When the "Restart with active frequency matching" is selected ([bb-41]=02).

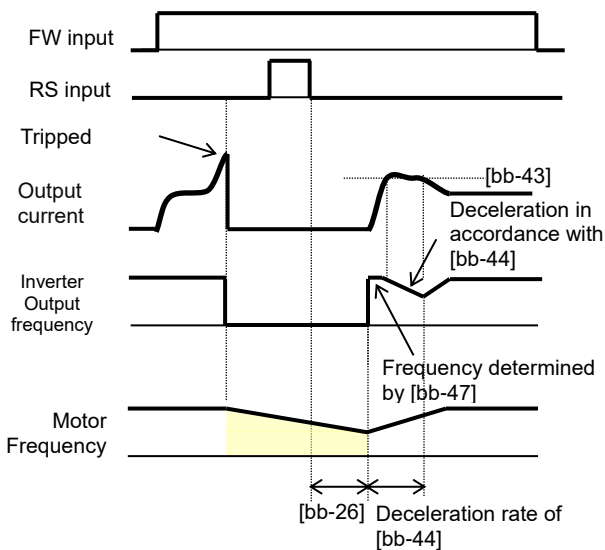

A

- After the "Retry wait time after instantaneous power failure/under-voltage error [bb-26]" has elapsed, the output starts at a frequency conforming to the "Active frequency matching restart constant (speed) [bb-44]". After that, during a time of the "Active frequency matching restart constant (voltage) [bb-45]," the motor speed is acquired. At that time, to reduce the output current with the "Active frequency matching restart level [bb-43]", deceleration occurs in accordance with the "Active frequency matching restart constant (speed) [bb-44]".
- When the output current lowers below the "Active frequency matching restart level [bb-43]", acceleration starts. If a trip occurs due to an excessive current even in this method, lower the "Active frequency matching restart level [bb-43]" or the "Active frequency matching restart constant (voltage) [bb-46]."

!

- When the Active frequency matching restart speed selection [bb-47] is set to 00 (the output frequency at shutdown), the inverter retry starts with frequency at the previous shut-down even if a reset signal is input during the waiting for retry status.

12.24.5 Analog Input Settings



- I want to input a frequency command or torque command by external analog input.
- I want to change the analog input characteristics such as "0 to 5 VDC becomes 0 Hz to maximum frequency command".



- The following explanation is an example when the frequency command input is selected as analog input. See the table at the end of this section for scaling of other available analog input commands.
- Note that the analog inputs are factory adjusted to 9.8 VDC / 19.8 mA at full scale command input.



- The SJ-P1 has three analog inputs Ai1, Ai2, Ai3, which can be used for inputting commands such as the frequency command, torque command, etc. (Ai1/Ai2 can change 0 to 10 VDC input or 0 to 20 mA input by DIP switch, Ai3 is fixed input from -10 to 10 VDC.) And Ai4/Ai5/Ai6 can be added by using the optional cassette P1-AG. (Ai4/Ai5 can change 0 to 10 VDC input or 0 to 20 mA input, Ai6 is -10 to 10 VDC fixed input.)
- The input characteristics such as the frequency command corresponding to the analog input value can be adjusted by the following analog input settings.

■ Adjusting the Analog input Ai1.

Name	Code	Data range (unit)	Description
[Ai1] Filter time constant	[Cb-01]	1 to 500(ms)	Filter for the analog input.
[Ai1] Start value	[Cb-03]	0.00 to 100.00(%)	Sets the start frequency when the analog input value is [Cb-05]. Sets the ratio (%) with the maximum frequency as 100%.
[Ai1] End value	[Cb-04]	0.00 to 100.00(%)	Sets the end frequency when the analog input value is [Cb-06]. Sets the ratio (%) with the maximum frequency as 100%.
[Ai1] Start rate	[Cb-05]	0.0 to [Cb-06](%)	Sets the start ratio (%) between analog input 0 to 10 VDC/0 to 20 mA.
[Ai1] End rate	[Cb-06]	[Cb-05] to 100.0(%)	Sets the end ratio (%) between analog input 0 to 10 VDC/0 to 20 mA.
[Ai1] Start value selection	[Cb-07]	00	As shown below (Example 1-1, 1-2), analog input value from 0% to [Cb-05] is fixed to [Cb-03].
		01	As shown below (Example 2-1, 2-2), analog input value is: At the [Cb-03] < [Cb-04], from 0% to [Cb-05] is fixed to 0 Hz. At the [Cb-03] > [Cb-04], from [Cb-06] to 100% is fixed to 0 Hz.

(Example 1-1) [Cb-07]=00.

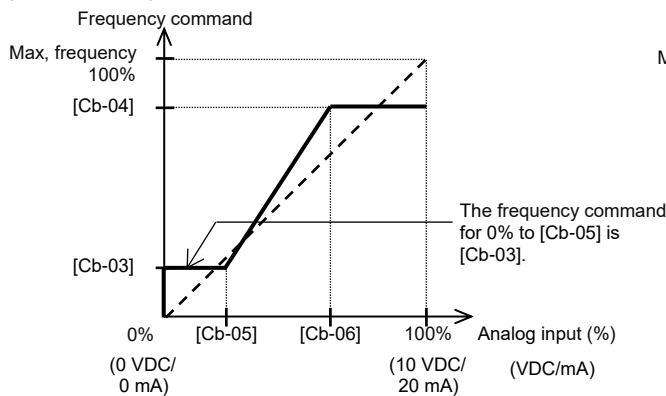

(Example 2-1) [Cb-07]=01.

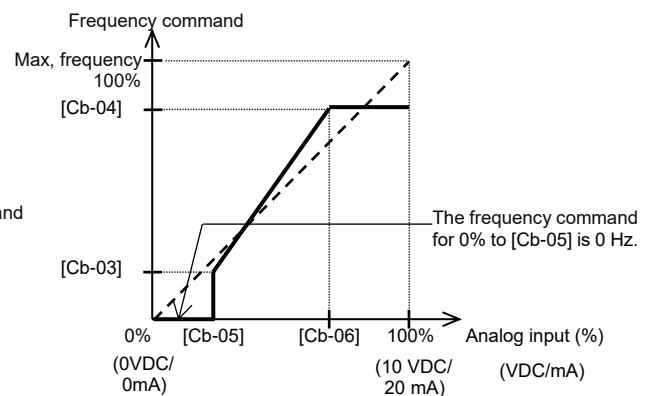

(Example 1-2) [Cb-07]=00.

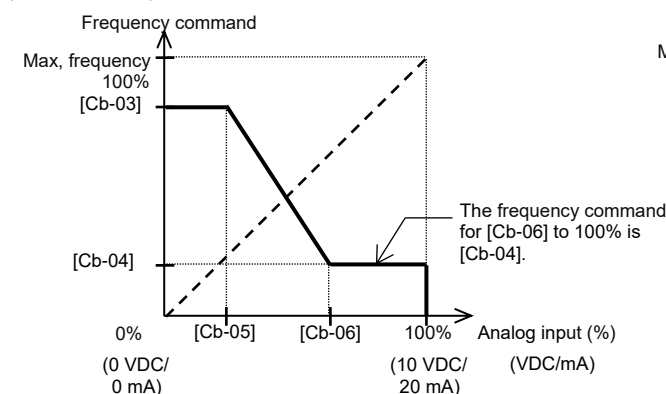

(Example 2-2) [Cb-07]=01.

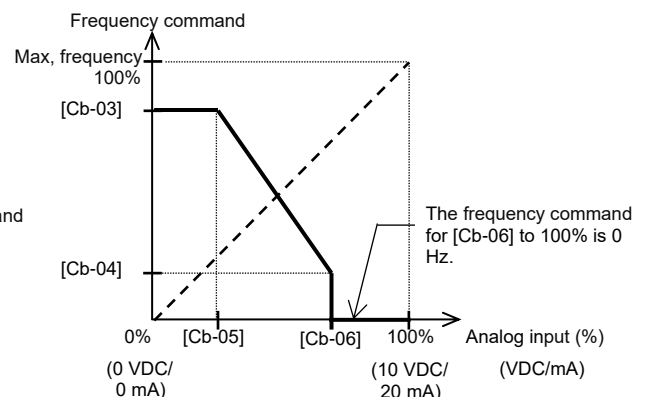

■ Adjusting the Analog input Ai2.

Name	Code	Data range (unit)	Description
[Ai2] Filter time constant	[Cb-11]	1 to 500(ms)	Filter for the analog input.
[Ai2] Start value	[Cb-13]	0.00 to 100.00(%)	Sets the start frequency when the analog input value is [Cb-15]. Sets the ratio (%) with the maximum frequency as 100%.
[Ai2] End value	[Cb-14]	0.00 to 100.00(%)	Sets the end frequency when the analog input value is [Cb-16]. Sets the ratio (%) with the maximum frequency as 100%.
[Ai2] Start rate	[Cb-15]	0.0 to [Cb-16](%)	Sets the start ratio (%) between analog input 0 to 10 VDC/0 to 20 mA.
[Ai2] End rate	[Cb-16]	[Cb-15] to 100.0(%)	Sets the end ratio (%) between analog input 0 to 10 VDC/0 to 20 mA.
[Ai2] Start value selection	[Cb-17]	00	As shown below (Example 3-1, 3-2), analog input value from 0% to [Cb-15] is fixed to [Cb-13].
		01	As shown below (Example 4-1, 4-2), analog input value is: At the [Cb-13] < [Cb-14], from 0% to [Cb-15] is fixed to 0 Hz. At the [Cb-13] > [Cb-14], from [Cb-16] to 100% is fixed to 0 Hz.

(Example 3-1) [Cb-17]=00.

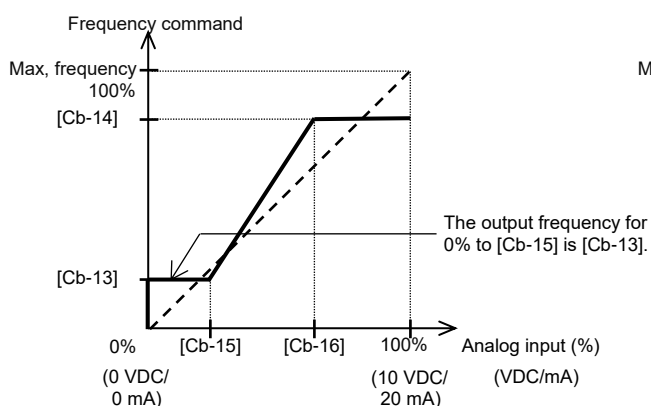

(Example 4-1) [Cb-17]=01.

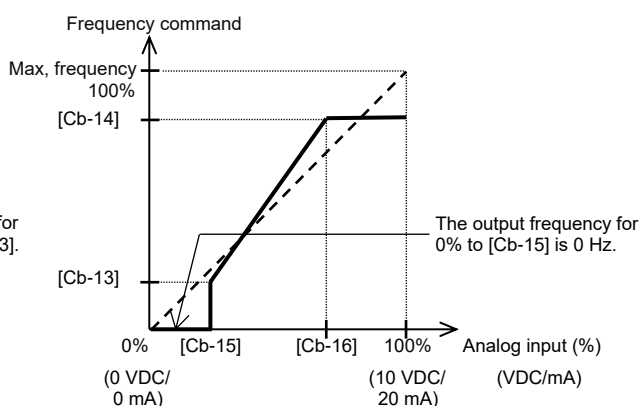

(Example 3-2) [Cb-17]=00.

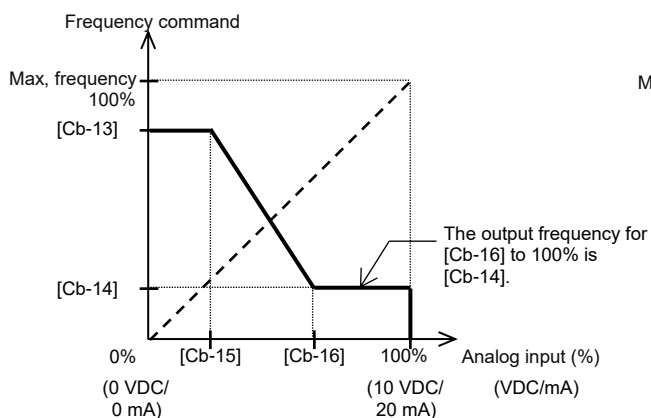

(Example 4-2) [Cb-17]=01.

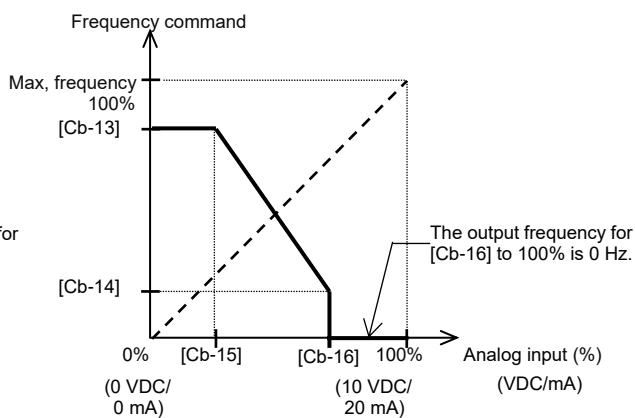

■ Adjusting the Analog input Ai3.

Name	Code	Data range (unit)	Description
[Ai3] Filter time constant	[Cb-21]	1 to 500(ms)	Filter for the input.
Terminal [Ai3] selection	[Cb-22]	00	Single.
		01	Added to Ai1/Ai2: Forward and Reverse.
		02	Added to Ai1/Ai2: Forward only.
[Ai3] Start value	[Cb-23]	-100.00 to 100.00(%)	Sets the start frequency when the analog input value is [Cb-25]. Sets the ratio (%) with the maximum frequency as 100%.
[Ai3] End value	[Cb-24]	-100.00 to 100.00(%)	Sets the end frequency when the analog input value is [Cb-26]. Sets the ratio (%) with the maximum frequency as 100%.
[Ai3] Start rate	[Cb-25]	-100.0 to [Cb-26](%)	Sets the start voltage between the analog input -10 VDC and 10 VDC in the ratio (%) corresponding to -100% to 100%.
[Ai3] End rate	[Cb-26]	[Cb-25] to 100.0(%)	Sets the end voltage between the analog input -10 to 10 VDC in the ratio (%) corresponding to -100% to 100%.

(Example 5)

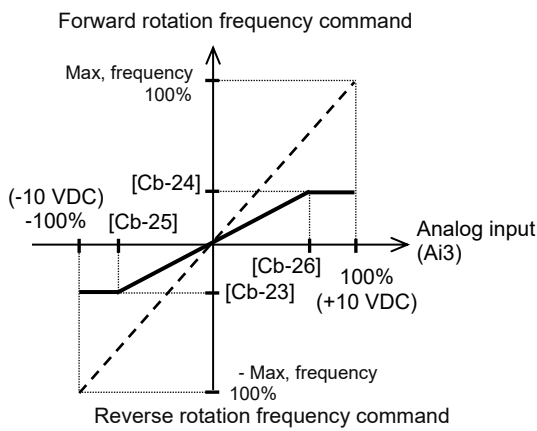

- Adding analog input [Ai3] to [Ai1] and [Ai2].
 - The input value of [Ai3] terminal can be forcibly added to the value of [Ai1]/[Ai2].

- Selects whether or not reversible output is possible for the added value of analog input by [Cb-22] setting.

(Example 6-1) [Cb-22]=01 (with reversibility).

(Example 6-2) [Cb-22]=02 (without reversibility).

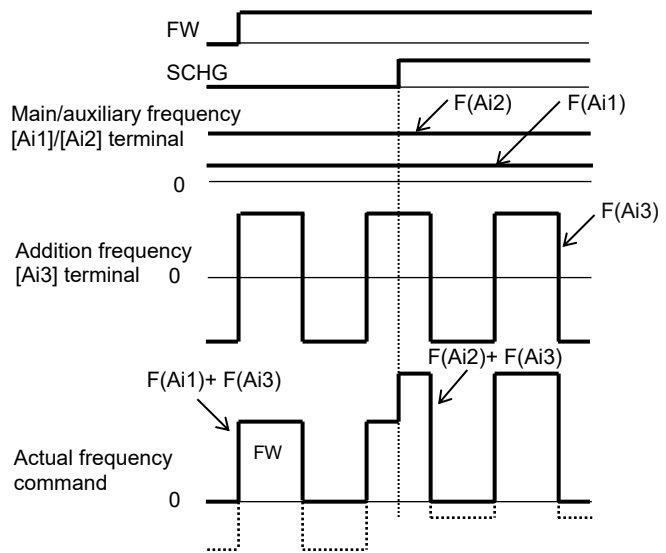
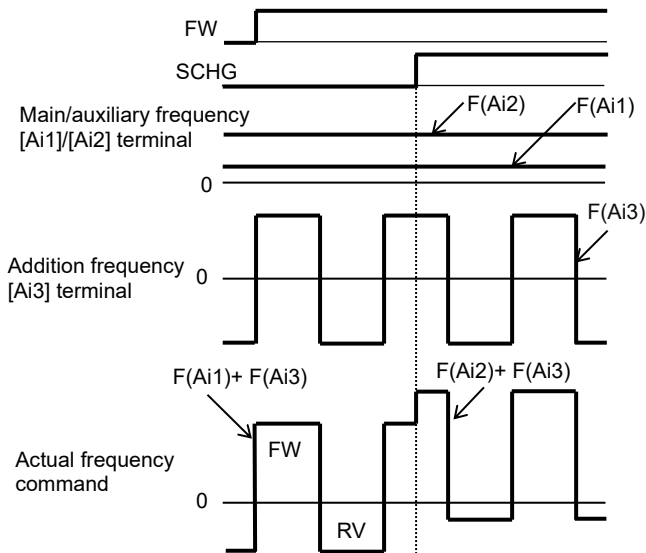

Note: "F(Ai*)" in the above figure is the frequency command from each analog input terminal.

- Stabilizing signals of analog inputs.
 - When frequency command is performed by external analog signal, analog input filter time constant can be set for voltage input or current input.
 - This feature is effective for removing noise from the analog input data.
- If noise adversely affects stable operation, increase the setting value. At the using analog input by PID control, the response of PID control becomes slower as the filter setting increases, so note that the desired characteristics may not be achieved.

Item	Parameter	Data	Description
[Ai1] Filter time constant	[Cb-01]	1 to 500 (ms)	Sets a time constant for the input filter.
[Ai2] Filter time constant	[Cb-11]	1 to 500 (ms)	Sets a time constant for the input filter.
[Ai3] Filter time constant	[Cb-21]	1 to 500 (ms)	Sets a time constant for the input filter.

- Fine adjustment for analog input.
- If there is deviation between the command input value and the analog input value, fine adjustment is possible by adding the bias adjustment value to the 0 VDC / 0 mA point and/or multiplying the gain to the slope of the input value.

- Normally, use this fine adjustment when a small deviation due to the influence of individual products, temperature environment, input device, etc., is corrected.
- When using the analog fine adjustment function, set the each analog input Start value/End value/Start rate/End rate parameters to the default values. Otherwise, adjustment will be so difficult.

Name	Code	Data range (unit)	Description
[Ai1] Voltage/Current bias adjustment	[Cb-30]	-100.00 to 100.00 (%)	Fine adjustment of the analog input 0 VDC / 0 mA point is performed by adding the bias value to the input command value. Set the ratio (%) with the full scale of the input command as 100%.
[Ai1] Voltage/Current gain adjustment	[Cb-31]	0 to 200.00 (%)	Fine adjustment of the slope of the reference line is performed by multiplying the gain value to the input command value. Set the ratio (%) based on "Full scale of input command/maximum analog input (10 VDC/20 mA) = 100%".
[Ai2] Voltage/Current bias adjustment	[Cb-32]	-100.00 to 100.00 (%)	Same as [Cb-30].
[Ai2] Voltage/Current gain adjustment	[Cb-33]	0 to 200.00 (%)	Same as [Cb-31].
[Ai3] Voltage bias adjustment	[Cb-34]	-100.00 to 100.00 (%)	Same as [Cb-30]. If the frequency reference is negative, the rotation is reverse.
[Ai3] Voltage gain adjustment	[Cb-35]	0 to 200.00 (%)	Same as [Cb-31]. If the frequency reference is negative, the rotation is reverse.

(Example 7-1) Fine adjustment for [Ai1].

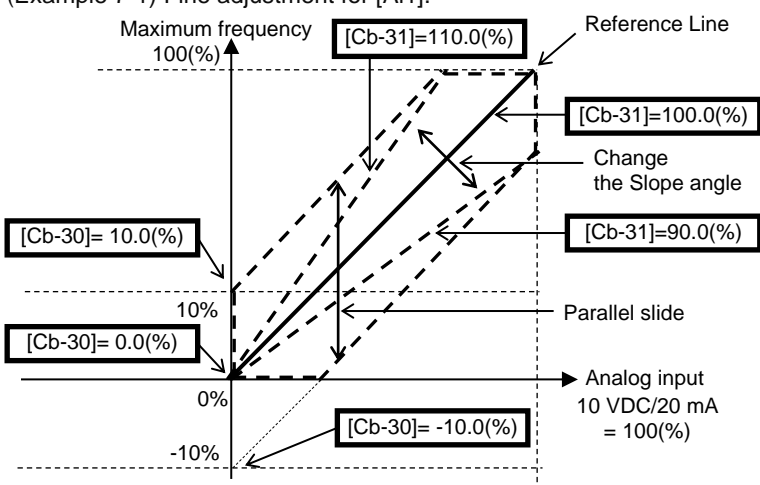

(Note that the analog input is adjusted at the factory to be 9.8 VDC / 19.8 mA at full scale of command input.)

(Example 7-2) Fine adjustment for [Ai3].

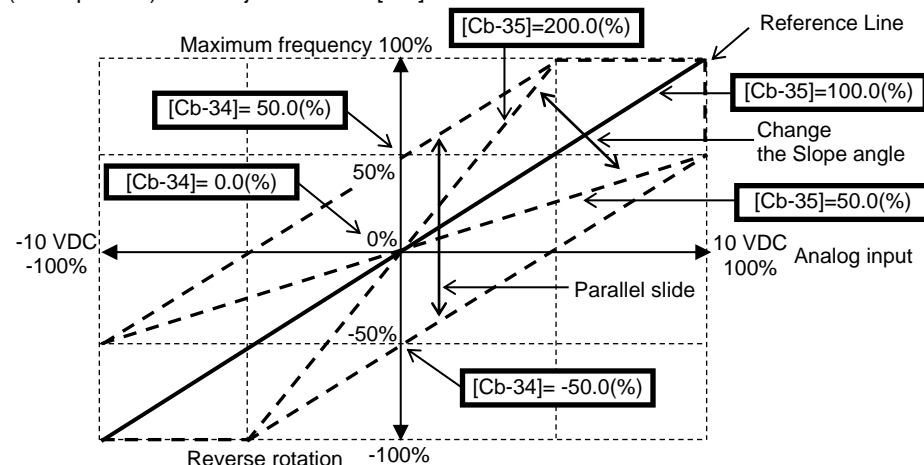

■ Analog input setting by P1-AG option.

The analog input function behaviour of Ai4/Ai5/Ai6 of the optional P1-AG is the same as the analog input Ai1/Ai2/Ai3 (except Cb-22). For details, refer to the explanation of related parameters with Ai1/Ai2/Ai3 read as Ai4/Ai5/Ai6.

For details of installation, wiring and etc., refer to P1-AG Analog Input / Output Option User's Guide NT260*X.

Name	Code	Data range (unit)	Description
[Ai4] Filter time constant	[oE-01]	1 to 500 (ms)	The operation of Ai4/Ai5/Ai6 is the same as Ai1/Ai2/Ai3. For details, refer to "Adjusting the Analog input Ai1 to Ai3" in this section 12.24.5. However, the function equivalent to the Terminal [Ai3] selection [Cb-22] is not available in the optional P1-AG.
[Ai4] Start value	[oE-03]	0.00 to 100.00 (%)	
[Ai4] End value	[oE-04]	0.00 to 100.00 (%)	
[Ai4] Start rate	[oE-05]	0.0 to [oE-06] (%)	
[Ai4] End rate	[oE-06]	[oE-05] to 100.0 (%)	
[Ai4] Start point selection	[oE-07]	00(Start value[oE-03])/01(0%)	
[Ai5] Filter time constant	[oE-11]	1 to 500 (ms)	
[Ai5] Start value	[oE-13]	0.00 to 100.00 (%)	
[Ai5] End value	[oE-14]	0.00 to 100.00 (%)	
[Ai5] Start rate	[oE-15]	0.0 to [oE-16] (%)	
[Ai5] End rate	[oE-16]	[oE-15] to 100.0 (%)	
[Ai5] Start point selection	[oE-17]	00(Start value[oE-13])/01(0%)	
[Ai6] Filter time constant	[oE-21]	1 to 500 (ms)	
[Ai6] Start value	[oE-23]	-100.00 to 100.00 (%)	
[Ai6] End value	[oE-24]	-100.00 to 100.00 (%)	
[Ai6] Start rate	[oE-25]	-100.0 to [oE-26] (%)	
[Ai6] End rate	[oE-26]	[oE-25] to 100.0 (%)	
[Ai4] Voltage/Current bias adjustment	[oE-28]	-100.00 to 100.00 (%)	The operation of Ai4/Ai5/Ai6 is the same as Ai1/Ai2/Ai3. For details, refer to "Fine adjustment for analog input" in this section 12.24.5.
[Ai4] Voltage/Current gain adjustment	[oE-29]	0- 200.00 (%)	
[Ai4] Voltage/Current bias adjustment	[oE-30]	-100.00 to 100.00 (%)	
[Ai4] Voltage/Current gain adjustment	[oE-31]	0 to 200.00 (%)	
[Ai4] Voltage bias adjustment	[oE-32]	-100.00 to 100.00 (%)	
[Ai4] Voltage gain adjustment	[oE-33]	0 to 200.00 (%)	
[Ai4] Window comparator upper limit	[oE-35]	0 to 100 (%)	The operation of Ai4/Ai5/Ai6 is the same as Ai1/Ai2/Ai3. For details, refer to "12.22.2 Disconnection or Out-of-Range Signals of Analog Input Terminals on the P1-AG Option".
[Ai4] Window comparator lower limit	[oE-36]	0 to 100 (%)	
[Ai4] Window comparator hysteresis width	[oE-37]	0 to 10 (%)	
[Ai5] Window comparator upper limit	[oE-38]	0 to 100 (%)	
[Ai5] Window comparator lower limit	[oE-39]	0 to 100 (%)	
[Ai5] Window comparator hysteresis width	[oE-40]	0 to 10 (%)	
[Ai6] Window comparator upper limit	[oE-41]	-100 to 100 (%)	
[Ai6] Window comparator lower limit	[oE-42]	-100 to 100 (%)	
[Ai6] Window comparator hysteresis width	[oE-43]	0 to 10 (%)	
[Ai4] Temporal operation level set at disconnection or compare event	[oE-44]	0 to 100 (%)	
[Ai4] Temporal operation level implementation timing	[oE-45]	00(Disable)/01(Enable(at WC*active))/02(Enable(at WC*de-active))	
[Ai5] Temporal operation level set at disconnection or compare event	[oE-46]	0 to 100 (%)	
[Ai5] Temporal operation level implementation timing	[oE-47]	00(Disable)/01(Enable(at WC*active))/02(Enable(at WC*de-active))	
[Ai6] Temporal operation level set at disconnection or compare event	[oE-48]	-100 to 100 (%)	
[Ai6] Temporal operation level implementation timing	[oE-49]	00(Disable)/01(Enable(at WC*active))/02(Enable(at WC*de-active))	

■ Selectable input commands and each scale range.

- The following table is a list of parameters that can be analog input, and shows the full-scale value at analog input. The full scale range depends on whether the input source is Ai1/Ai2(Ai4/Ai5) or Ai3(Ai6).
- The input ranges below are when each Start value/Start rate is set to 0% and each End value/End rate is set to 100%.
- Note that the analog inputs are factory adjusted to 9.8 VDC / 19.8 mA at full scale command input.

Code	Name	Scale range of each command and analog input (Upper rows are Ai1/Ai2/Ai4/Ai5, And lower rows are Ai3/Ai6)	
AA101, AA102, AA201, AA202	Main / Sub speed input source selection	0.00 to Max. frequency setting (Hz)	0 to 10 VDC / 0 to 20 mA
		- Max. frequency to Max. frequency setting (Hz)	-10 to 10 VDC
Ad-01, Ad-11	Torque reference / Torque bias input source selection	0.0 to 500.0 (%)	0 to 10 VDC / 0 to 20 mA
		- 500.0 to 500.0 (%)	-10 to 10 VDC
Ad-40	Speed limit input source selection at torque control	0.00 to Max. frequency setting (Hz)	0 to 10 VDC / 0 to 20 mA
		- Max. frequency to Max. frequency setting (Hz)	-10 to 10 VDC
AH-07, AH-42, AH-46, AJ-07, AJ-27, AJ-47	PID set-point input source selection	0.00 to 100.00 (%)	0 to 10 VDC / 0 to 20 mA
		-100.00 to 100.00 (%)	-10 to 10 VDC
AH-51, AH-52, AH-53, AJ-12, AJ-32, AJ-52	PID feedback input source selection	0.00 to 100.00 (%)	0 to 10 VDC / 0 to 20 mA
		-100.00 to 100.00 (%)	-10 to 10 VDC
AH-70	PID1 feed-forward input source selection	0.00 to 100.00 (%)	0 to 10 VDC / 0 to 20 mA
		-100.00 to 100.00 (%)	-10 to 10 VDC
bA101, bA201	Upper frequency limit source selection	0.00 to Max. frequency setting (Hz)	0 to 10 VDC / 0 to 20 mA
		- Max. frequency to Max. frequency setting (Hz)	-10 to 10 VDC
bA110, bA210	Torque limit selection	0.0 to 500.0 (%)	0 to 10 VDC / 0 to 20 mA
		- 500.0 to 500.0 (%)	-10 to 10 VDC
CA-70	Speed reference source selection when [F-OP] is active	0.00 to Max. frequency setting (Hz)	0 to 10 VDC / 0 to 20 mA
		- Max. frequency to Max. frequency setting (Hz)	-10 to 10 VDC
PA-22	Simulation mode: Optional output selection for the output current monitor	(0 to 3.0) × Inverter rated current (A)	0 to 10 VDC / 0 to 20 mA
		(0 to 3.0) × Inverter rated current (A)	0 to 10 VDC (-10 to 0 VDC input becomes 0)
PA-24	Simulation mode: Optional output selection for the DC bus voltage monitor	0.0 to 450.0 (VDC) (200V class) 0.0 to 900.0 (VDC) (400V class)	0 to 10 VDC / 0 to 20 mA
		0.0 to 450.0 (VDC) (200V class) 0.0 to 900.0 (VDC) (400V class)	0 to 10 VDC (-10 to 0 VDC input becomes 0)
PA-26	Simulation mode: Optional output selection for the output voltage monitor	0.0 to 300.0 (VDC) (200V class) 0.0 to 600.0 (VDC) (400V class)	0 to 10 VDC / 0 to 20 mA
		0.0 to 300.0 (VDC) (200V class) 0.0 to 600.0 (VDC) (400V class)	0 to 10 VDC (-10 to 0 VDC input becomes 0)
PA-28	Simulation mode: Optional output selection for the output torque monitor	0.0 to 500.0 (%)	0 to 10 VDC / 0 to 20 mA
		- 500.0 to 500.0 (%)	-10 to 10 VDC
PA-30	Simulation mode: Optional frequency matching start enable setting	0.00 to Max. frequency setting (Hz)	0 to 10 VDC / 0 to 20 mA
		- Max. frequency to Max. frequency setting (Hz)	-10 to 10 VDC

12.24.6 Checking the Number of Input Pulses

Q

- I want to count the number of pulses of the pulse train input.
- I want to output an ON/OFF signal according to the pulse train input count.

A

- For the pulse counting function, the terminal input monitoring mode and the phase coefficient monitoring mode are available.
- When the "Pulse train input, target function selection [CA-90]" ranges from 00 to 02, the terminal input monitoring mode becomes valid. When [CA-90] is set to 03(Pulse count), the phase coefficient monitoring mode becomes valid.
- You can monitor the acquired pulses with the pulse counter monitor served as an accumulation counter.
- By turning on [PCC] (Pulse counter clearing), you can clear the accumulated counter value.

!

- The maximum input pulse in the phase coefficient monitoring mode becomes a maximum of 32 kpps. (When the duty ratio is approximately 50%)
- An accumulation counter value cannot be stored. After the power supply is turned on, the value becomes zero.
- The maximum input pulse in the terminal input monitoring mode depends on the settings of the input terminal response times [CA-41] to [CA-51].

Parameters.

Name	Code	Data range (unit)	Description
Input terminal function	[CA-01] to [CA-11]	103	[PLA]: Pulse count A
		104	[PLB]: Pulse count B
		097	[PCC]: Pulse counter clearing
Output terminal function	[CC-01] to [CC-07]	044	[PCMP]: Pulse count compare match output
Pulse train input, target function selection (Internal)	[CA-90]	00	Disable
		01	Frequency reference
		02	Speed feedback
		03	Pulse count
Pulse train input mode selection (Internal)	[CA-91]	00	90 degrees shift pulse train
		01	Forward/Reverse pulse train and direction signal
		02	Forward pulse train and reverse pulse train
Pulse counter compare match output ON value	[CA-97]	0 to 65535	When the number of pulses reaches this set value, Turn on [PCMP].
Pulse counter compare match output OFF value	[CA-98]	0 to 65535	When the number of pulses reaches this set value, Turn off [PCMP].
Pulse counter maximum value	[CA-99]	0 to 65535	A one-shot pulse can be achieved when the value is 0. When the number of pulses reaches the set value, the internal counter is cleared.
Pulse count monitor	[dA-28]	0 to 2147483647	Displays the counter integrated value.

- Terminal input monitoring mode ([CA-90]=00 to 02).
 - Monitors whether the input terminal functions [PLA] and [PLB] are turned on.

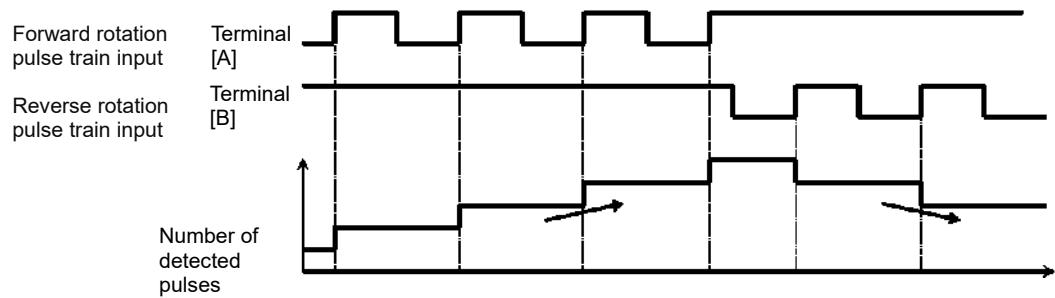

- Phase coefficient monitoring mode ([CA-90]=03).
 - Input terminals [A] and [B] become available for pulse train inputs.

(1) Mode 0: 90 degrees shift pulse train ([CA-91]=00).

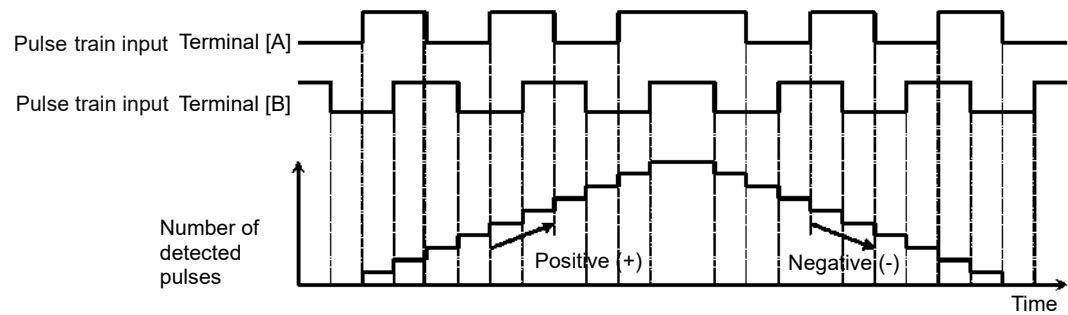

(2) Mode 1: Forward/Reverse pulse train and direction signal ([CA-91]=01).

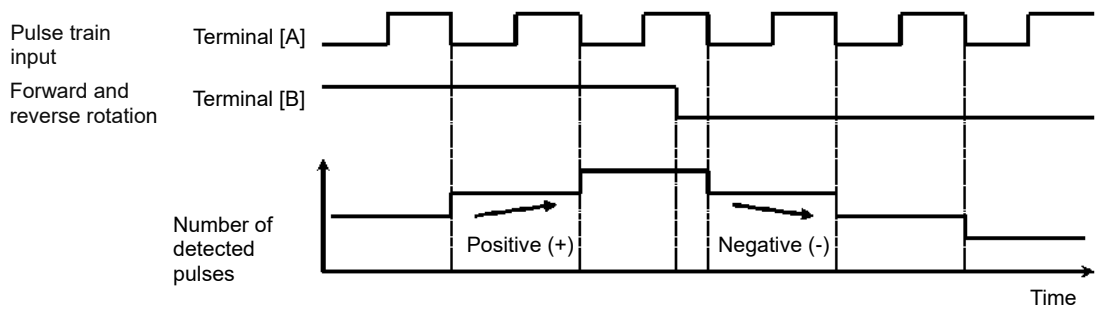

(3) Mode 2: Forward pulse train and reverse pulse train ([CA-91]=02).

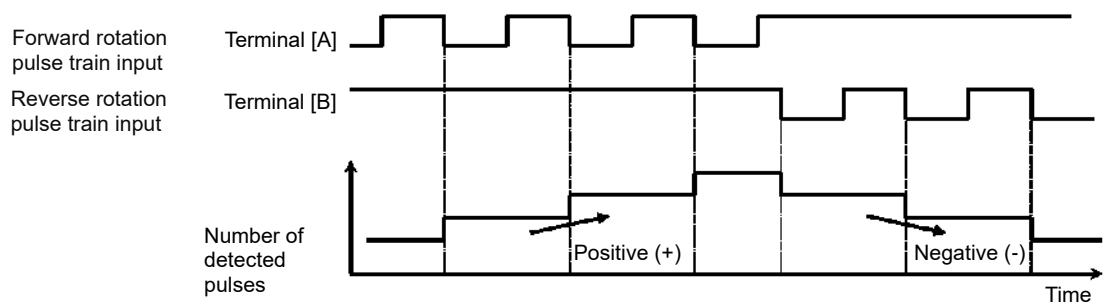

■ Example of pulse counter operation.

- The following shows how the pulse counter operates.
- The captured pulse can be monitored by the Pulse counter monitor [dA-28] as a cumulative counter.

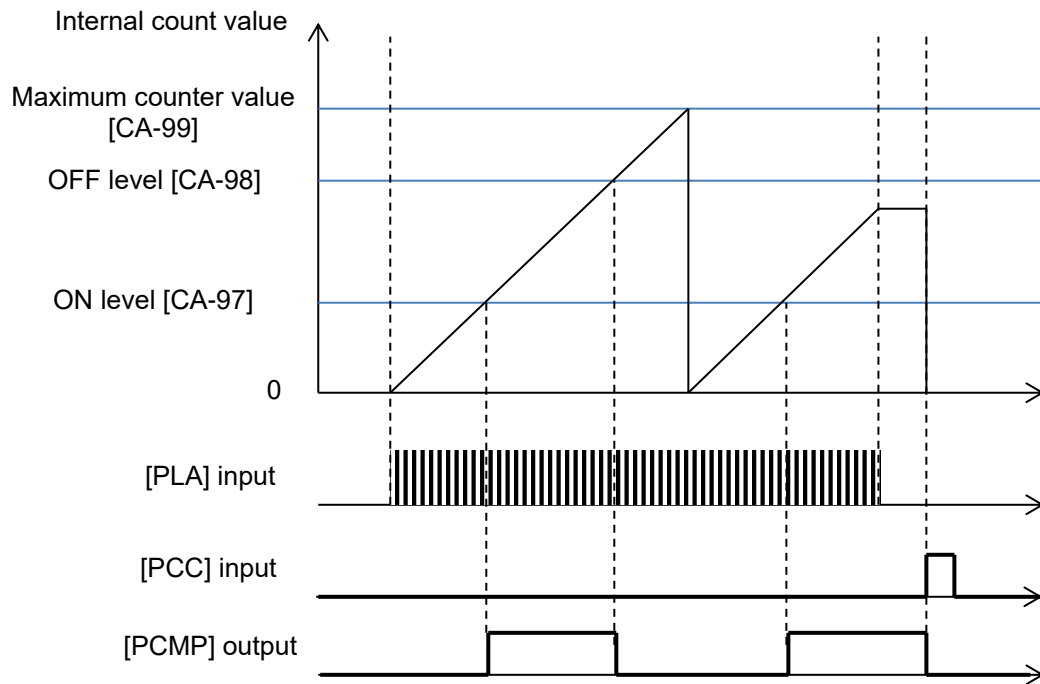

12.24.7 Performing Resetting Automatically

Q

- I want to reset an error with an operation for which an RUN command is turned off.
- I want to reset automatically a resettable trip and restart the inverter.

!

- When the "[bb-10] Automatic error reset selection" is set to 01, resetting starts when the STOP/RESET key is pressed as long as an RUN command is given through the operator keypad.
- When resetting is performed manually, and a control power supply is turned on again, the number of automatic resetting counted in internal is cleared.

A

- When the "[bb-10] Automatic error reset selection" is set to 01, resetting is performed after the "[bb-12] Automatic error reset wait time" has elapsed from when an RUN command has been turned off.
- When the "[bb-10] Automatic error reset selection" is set to 02, resetting is performed after the "[bb-12] Automatic error reset wait time" has elapsed from when an error has occurred.

- By setting the "Alarm signal selection at automatic error reset [bb-11]" to 01 while automatic resetting is valid, you can invalidate the output of the "Alarm [AL]" during automatic resetting operation.
- Upon automatic resetting has been performed for the number of times set with the "[bb-13] Automatic error reset number", no error will be released, but a trip occurs.

■ Example operation of automatic resetting.
(Example 1) When [bb-10]=01

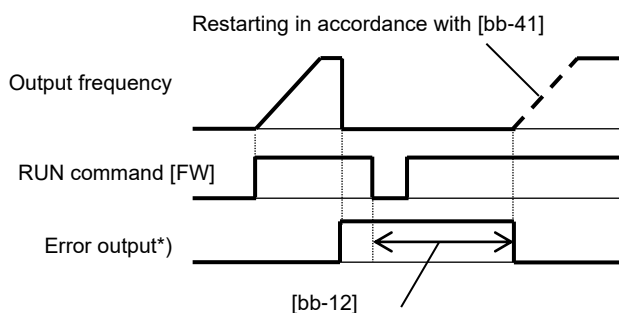

(Example 2) When [bb-10]=02

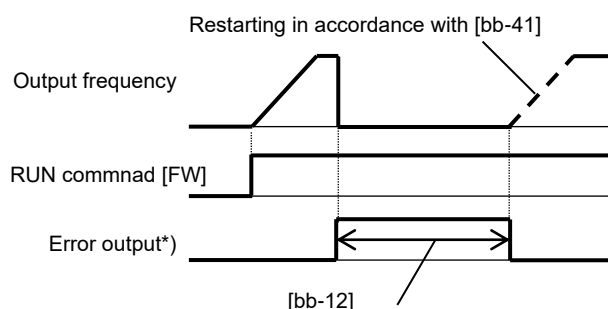

*) When [bb-11]=00, the error output becomes the [AL] output.

■ Parameters.

Name	Code	Data range (unit)	Description
Automatic error reset selection	[bb-10]	00	Disable
		01	Resetting starts when the RUN command is turned off.
		02	Resetting starts after the set time has elapsed.
Alarm signal selection at automatic error reset	[bb-11]	00	Outputting is available.
		01	Outputting is not available.
Automatic error reset wait time	[bb-12]	0 to 600(s)	Sets a stand-by time from when resetting starts to when actual resetting starts.
Automatic error reset number	[bb-13]	0 to 10 (times)	Sets the number of automatic resetting.
Restart mode after RS release	[bb-41]	00	Restart at 0Hz
		01	Restart with frequency matching
		02	Restart with active frequency matching
		03	Detect speed *1)

*1) For frequency matching by detection speed, feedback input to input terminals A and B or feedback input to option P1-FB is required.

(memo)

12.25 Functions with Output Terminal Signal

12.25.1 Intelligent Output Terminal Function Settings



- I want to detect warning signals, error signals, and state signals issued by the inverter with an external system.



- To use the contact c relay, please check the control circuit power supply and the relay output terminals whether they are turned on or off.



- Output terminals 11 to 15, 16A-16C, AL0-AL1 / AL0-AL2 are intelligent output terminals. Each function on the next page is assigned to each output terminal by parameter.
- Output terminals 11 to 15 are open collector outputs, 16A-16C is a relay of A contact output, and AL0-AL1 / AL0-AL2 is a relay of C contact output.
- For the content of an output signal, by allocating the functions that you want to output to [CC-01] to [CC-07], you will be able to allow the corresponding output terminal contacts to operate.
- You can switch an output signal level with the Contacts a/b selection functions of [CC-11] to [CC-17].

Parameters.

Name	Code	Data range (unit)	Description
Output terminal [11] to [16], [AL] function	[CC-01] to [CC-07]	Next item: Table of output terminal selections	Outputs the allocated function to the corresponding output terminal.
Output terminal [11] to [16], [AL] active state	[CC-11] to [CC-17]	00	Operates as Contact a (NO).
		01	Operates as Contact b (NC).

Terminals corresponding to parameters.

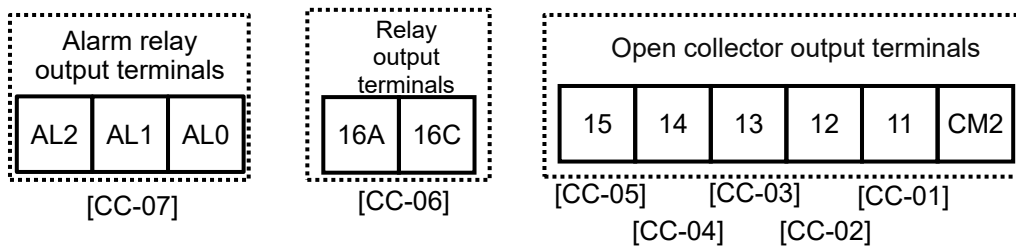

■ Table of output terminal selections.

No.	Abbreviation	Function name	Page
000	no	Not use	-
001	RUN	Running	12-20-1
002	FA1	Constant-frequency reached	12-21-1
003	FA2	Set frequency overreached	12-21-2
004	FA3	Set frequency reached	12-21-3
005	FA4	Set frequency overreached 2	12-21-2
006	FA5	Set frequency reached	12-21-3
007	IRDY	inverter ready	12-20-4
008	FWR	Forward rotation	12-20-2
009	RVR	Reverse rotation	12-20-2
010	FREF	Frequency reference = Keypad is selected	12-4-2
011	REF	Run command = Keypad is selected	12-5-2
012	SETM	2nd control is selected	12-17-1
016	OPO	Option output *1)	—
017	AL	Alarm	12-19-1
018	MJA	Major failure	12-19-3
019	OTQ	Over-torque *2)	12-11-9
020	IP	Instantaneous power failure	12-19-8
021	UV	Undervoltage	12-19-9
022	TRQ	Torque limited *2)	12-11-7
023	IPS	IP-Non stop function is active	12-13-17
024	RNT	Accumulated operation time over	12-19-15
025	ONT	Accumulated power-on time over	12-19-16
026	THM	Electronic thermal alarm (Motor)	12-19-10
027	THC	Electronic thermal alarm (Inverter)	12-19-11
029	WAC	Capacitor life warning	12-19-13
030	WAF	Cooling-fan speed drop	12-19-14
031	FR	RUN command active	12-20-3
032	OHF	Heat sink overheat warning	12-19-12
033	LOC	Low-current indication	12-19-7
034	LOC2	Low-current indication 2	12-19-7
035	OL	Overload warning notice	12-19-6
036	OL2	Overload warning notice 2	12-19-6
037	BRK	Brake release	12-17-5
038	BER	Brake error	12-17-5
039	CON	Contact control	12-17-10
040	ZS	Zero speed detection	12-21-4
041	DSE	Speed over deviation	12-16-11
042	PDD	Position over deviation	12-17-21
043	POK	Positioning completed	12-17-22 12-17-25
044	PCMP	Pulse count compare match output	12-24-16
045	OD	Over deviation for PID control	12-10-28
046	FBV	PID1 feedback comparison	12-10-29
047	OD2	Over deviation for PID2 control	12-10-28
048	FBV2	PID2 feedback comparison	12-10-29
049	NDc	Communication line disconnection	14-5

No.	Abbreviation	Function name	Page
050	Ai1Dc	Analog [Ai1] disconnection detection	12-22-1
051	Ai2Dc	Analog [Ai2] disconnection detection	12-22-1
052	Ai3Dc	Analog [Ai3] disconnection detection	12-22-1
053	Ai4Dc	Analog [Ai4] disconnection detection	12-22-4
054	Ai5Dc	Analog [Ai5] disconnection detection	12-22-4
055	Ai6Dc	Analog [Ai6] disconnection detection	12-22-4
056	WCAi1	Window comparator Ai1	12-22-1
057	WCAi2	Window comparator Ai2	12-22-1
058	WCAi3	Window comparator Ai3	12-22-1
059	WCAi4	Window comparator Ai4	12-22-4
060	WCAi5	Window comparator Ai5	12-22-4
061	WCAi6	Window comparator Ai6	12-22-4
062	LOG1	Logical operation result 1	12-23-1
063	LOG2	Logical operation result 2	
064	LOG3	Logical operation result 3	
065	LOG4	Logical operation result 4	
066	LOG5	Logical operation result 5	
067	LOG6	Logical operation result 6	
068	LOG7	Logical operation result 7	
069	MO1	General-purpose output 1	16-6
070	MO2	General-purpose output 2	
071	MO3	General-purpose output 3	
072	MO4	General-purpose output 4	
073	MO5	General-purpose output 5	
074	MO6	General-purpose output 6	
075	MO7	General-purpose output 7	
076	EMFC	Emergency force drive indicator	12-17-13
077	EMBP	Bypass mode indicator	12-17-15
078	WFT	Trace function waiting for trigger	16-7
079	TRA	Trace function data logging	16-7
080	LBK	Low-battery of keypad	9-41
081	OVS	Over-Voltage power Supply	12-19-17
084	AC0	Alarm code bit-0	12-19-4
085	AC1	Alarm code bit-1	
086	AC2	Alarm code bit-2	
087	AC3	Alarm code bit-3	
089	OD3	Over deviation for PID3 control	12-10-28
090	FBV3	PID3 feedback comparison	12-10-29
091	OD4	Over deviation for PID4 control	12-10-28
092	FBV4	PID4 feedback comparison	12-10-29
093	SSE	PID soft start error	12-10-16

*1) [OPO] "Option output" function is not currently functioning for future expansion. Therefore, do not assign.

*2) These torque related functions are valid when the Control mode selection [AA121] / [AA221] is set to 08(IM-SLV), 09(IM-0Hz-SLV), or 10(IM-CLV).

(memo)

12.25.2 Changing the Output Signals Logic Level



- I want to reverse the output signal logic and output.
- I want to switch the a / b contact by setting the inverter.



- You can set output specifications for Contact a or Contact b separately for Output terminals 11 to 15 and Relay output terminals 16 and 17.

■ Parameters.

Name	Code	Data range (unit)	Description
Output terminal [11] to [16], [AL] active state	[CC-11] to [CC-17]	00	Contact a (normally open) operation
		01	Contact b (normally closed) operation

- Contact a: Closes with "ON," and opens with "OFF."
- Contact b: Closes with "OFF," and opens with "ON."

■ Open collector output terminals.

- The specifications of Output terminals 11 to 15 are as shown below. The same specifications are applied.

- The open collector output operation is as shown below.

Electrical characteristics	
Terminals (11 to 15) to CM2	Voltage drop at ON: 4 V or below Allowable maximum voltage: 27 VDC Allowable maximum current: 50 mA These are available for both Sink and Source logics.

[CC-11] to [CC-15]	Control power supply	Output of inverter function	Open collector operation
00 (Contact a)	On	ON	Close
	Off	OFF	Open
01 (Contact b)	On	ON	Open
	Off	OFF	Close

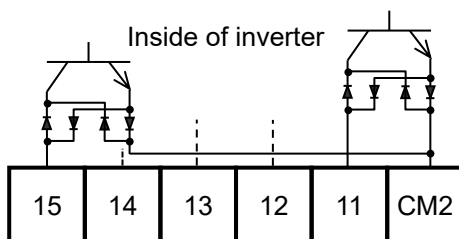

- Relay 1a output terminals.
- The specifications of Relay 1a output terminals 16A to 16C are as shown below.

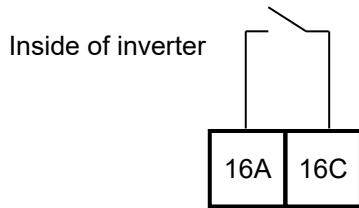

		Resistance load	Induced load
16A - 16C	Maximum contact capacity	250 VAC, 2 A 30 VDC, 3 A	250 VAC, 1 A 30 VDC, 0.6 A
	Minimum contact capacity	5 VDC, 10 mA	

- The operations of 16A to 16C are as shown below.

[CC-16]	Control power supply	Output of inverter function	Relay operation
00 (Contact a)	On	ON	Close
		OFF	Open
01 (Contact b)	On	ON	Open
		OFF	Close
	Off	-	Open

- Relay 1c output terminals.
- The specification of Relay 1c output terminals AL1 to AL0/AL2 to AL0 are as shown below.

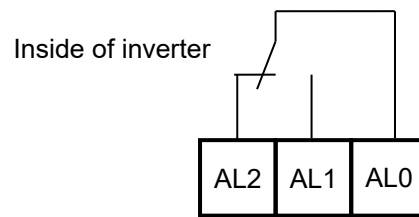

		Resistance load	Induced load
AL1 - AL0	Maximum contact capacity	250 VAC, 2 A 30 VDC, 3 A	250 VAC, 0.2 A 30 VDC, 0.6 A
	Minimum contact capacity	100 VAC, 10 mA 5 VDC, 100 mA	
AL2-AL0	Maximum contact capacity	250 VAC, 1A 30 VDC, 1A	250 VAC, 0.2 A 30 VDC, 0.2 A
	Minimum contact capacity	100 VAC, 10 mA 5 VDC, 100 mA	

- The operations of AL1 to AL0/AL2 to AL0 are as shown below.

[CC-17]	Control power supply	Output of inverter function	Output terminal state	
			AL1-AL0	AL2-AL0
00	On	ON	Close	Open
		OFF	Open	Close
01 (Initial value)	On	ON	Open	Close
		OFF	Close	Open
	Off	-	Open	Close

12.25.3 Delaying and holding output signals

Q

- I want to delay the response to an output signal.
- I want to reduce fluctuation of signal as much as possible.

A

- On-delay time and off-delay time can be set for each output terminal.
See the table on the right for the setting parameters of each output terminal.

!

- All output signals immediately turn ON/OFF upon a condition is satisfied. Therefore, Output signal chattering may occur depending on a selected signal. This function is available for retaining/hold the signal in such case.

Output terminals	On-delay time	Off-delay time
11	[CC-20]	[CC-21]
12	[CC-22]	[CC-23]
13	[CC-24]	[CC-25]
14	[CC-26]	[CC-27]
15	[CC-28]	[CC-29]
16A - 16C	[CC-30]	[CC-31]
AL1 - AL0/ AL2 - AL0	[CC-32]	[CC-33]

■ Parameters.

Name	Code	Data range (unit)	Description
Output terminal on-delay time	[CC-20]/[CC-22]/ [CC-24]/[CC-26]/ [CC-28]/[CC-30]/ [CC-32]	0.00 to 100.00(s)	Sets an on-delay time.
Output terminal off-delay time	[CC-21]/[CC-23]/ [CC-25]/[CC-27]/ [CC-29]/[CC-31]/ [CC-33]	0.00 to 100.00(s)	Sets an off-delay time.

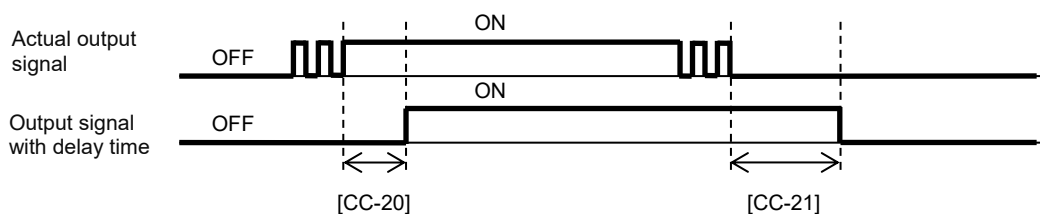

12.25.4 Monitor Data Selectable with Analog or Digital Output

Q

- I want to output the inverter monitors data from the analog or digital output terminal.

A

- The monitor data shown in the table below can be output as analog data from the Ao1/Ao2 terminals and as digital data from the FM terminals. (Ao1/Ao2 can change 0 to 10 VDC output or 0 to 20 mA output by DIP switches.)
- And Ao3/Ao4/Ao5 analog output can be added by using the optional cassette P1-AG. (Ao3/Ao4 can change 0 to 10 VDC input or 0 to 20 mA output, Ao5 is -10 to 10 VDC fixed output. For details of installation, wiring and etc., refer to P1-AG Analog Input / Output Option User's Guide NT260*X.)



- For the negative value of "Outputting is possible with (±)" in the table below, when the Data type selection parameter of each output terminal is set to 00, the positive value of absolute value is output.
- If the data type selection parameter is set to 01, negative data will be output as negative. However, the output data becomes 0 because the output terminal is positive voltage/current output. In such a case, the value in the negative range can be output by adjusting the Bias adjustment parameters. (Alternatively, Ao5 of P1-AG is -10 to 10 VDC output, so data in the negative range can be output as a negative voltage.)
- The output scale ranges below are when each bias setting is set to 0% and the each gain setting is set to 100%.

Selectable output monitors and each scale range.

Code	Name	Output scale range (Corresponding to 0 to 10 VDC / 0 to 20 mA / 0 to 100%)	Remarks
dA-01	Output frequency monitor	0.00 to maximum frequency (Hz)	
dA-02	Output current monitor	(0.00 to 2.00) × Inverter rated current (A)	
dA-04	Frequency reference monitor (after calculation) *1)	0.00 to ± maximum frequency (Hz)	Outputting is possible with (±).
dA-08	Detect speed monitor	0.00 to ± maximum frequency (Hz)	Outputting is possible with (±).
dA-12	Output frequency monitor (signed)	0.00 to ± maximum frequency (Hz)	Outputting is possible with (±).
dA-14	Frequency upper limit monitor	0.00 to maximum frequency (Hz)	
dA-15	Torque reference monitor (after calculation) *1) *2)	0.0 to ±1000.0 (%) of torque reference *4)	Outputting is possible with (±).
dA-16	Torque limit monitor *2)	0.0 to 500.0 (%) of torque reference *4)	
dA-17	Output torque monitor *2)	0.0 to ±1000.0 (%) of torque reference *4)	Outputting is possible with (±).
dA-18	Output voltage monitor (RMS)	0 to rated output voltage × 133 % (V)	About 75% of full scale is the rated output.
dA-30	Input power monitor	0.00 to inverter capacity × 200% (kW)	
dA-34	Output power monitor	0.00 to inverter capacity × 200% (kW)	
dA-38	Motor temperature monitor *3)	-20.0 to 200.0 (°C)	
dA-40	DC bus voltage monitor (P-N voltage)	0.0 to 1000.0 (VDC)	
dA-41	BRD load rate monitor	0.00 to 100.00 (%)	
dA-42	Electronic thermal load rating monitor (MTR)	0.00 to 100.00 (%)	
dA-43	Electronic thermal load rating monitor (CTL)	0.00 to 100.00 (%)	
dA-61	Analog input [Ai1] monitor	0.00 to 100.00 (%)	
dA-62	Analog input [Ai2] monitor	0.00 to 100.00 (%)	
dA-63	Analog input [Ai3] monitor	0.00 to ±100.00 (%)	Outputting is possible with (±).
dA-64	Analog input [Ai4] monitor	0.00 to 100.00 (%)	
dA-65	Analog input [Ai5] monitor	0.00 to 100.00 (%)	
dA-66	Analog input [Ai6] monitor	0.00 to ±100.00 (%)	Outputting is possible with (±).
dA-70	Pulse train input monitor (internal)	0.00 to ±100.00 (%)	Outputting is possible with (±).
dA-71	Pulse train input monitor (option)	0.00 to ±100.00 (%)	Outputting is possible with (±).

*1) (After calculation) means that it is after calculation such as auxiliary speed or addition frequency and calculation such as torque bias.

*2) These torque related functions are valid when the Control mode selection [AA121] / [AA221] is set to 08(IM-SLV), 09(IM-0Hz-SLV), or 10(IM-CLV). [dA-15] is valid at 08 or 10.

*3) Valid only when an NTC type external thermistor is connected. For details, refer to "12.7.2 Monitoring of Motor Temperature".

*4) The torque reference value (100%) is selected with the [HC115] / [HC215]. For details, refer to "12.11.8 Torque Reference Settings for Torque Control".

Code	Name	Output scale range (Corresponding to 0 to 10 VDC / 0 to 20 mA / 0 to 100%)	Remarks
db-18	Analog output monitor YA0	0.00 to 100.00 (%)	
db-19	Analog output monitor YA1	0.00 to 100.00 (%)	
db-20	Analog output monitor YA2	0.00 to 100.00 (%)	
db-21	Analog output monitor YA3	0.00 to 100.00 (%)	
db-22	Analog output monitor YA4	0.00 to 100.00 (%)	
db-23	Analog output monitor YA5	0.00 to 100.00 (%)	
db-30	PID1 feedback value 1 monitor	0.00 to ± 100.00 (%) *1)	Outputting is possible with (\pm).
db-32	PID1 feedback value 2 monitor	0.00 to ± 100.00 (%) *1)	Outputting is possible with (\pm).
db-34	PID1 feedback value 3 monitor	0.00 to ± 100.00 (%) *1)	Outputting is possible with (\pm).
db-36	PID2 feedback value monitor	0.00 to ± 100.00 (%) *2)	Outputting is possible with (\pm).
db-38	PID3 feedback value monitor	0.00 to ± 100.00 (%) *3)	Outputting is possible with (\pm).
db-40	PID4 feedback value monitor	0.00 to ± 100.00 (%) *4)	Outputting is possible with (\pm).
db-42	PID1 target value monitor (after calculation)	0.00 to ± 100.00 (%) *1)	Outputting is possible with (\pm).
db-44	PID1 feedback value monitor (after calculation)	0.00 to ± 100.00 (%) *1)	Outputting is possible with (\pm).
db-50	PID1 output monitor	0.00 to ± 100.00 (%)	Outputting is possible with (\pm).
db-51	PID1 deviation monitor	0.00 to ± 200.00 (%)	Outputting is possible with (\pm).
db-52	PID1 deviation 1 monitor	0.00 to ± 200.00 (%)	Outputting is possible with (\pm).
db-53	PID1 deviation 2 monitor	0.00 to ± 200.00 (%)	Outputting is possible with (\pm).
db-54	PID1 deviation 3 monitor	0.00 to ± 200.00 (%)	Outputting is possible with (\pm).
db-55	PID2 output monitor	0.00 to ± 100.00 (%)	Outputting is possible with (\pm).
db-56	PID2 deviation monitor	0.00 to ± 200.00 (%)	Outputting is possible with (\pm).
db-57	PID3 output monitor	0.00 to ± 100.00 (%)	Outputting is possible with (\pm).
db-58	PID3 deviation monitor	0.00 to ± 200.00 (%)	Outputting is possible with (\pm).
db-59	PID4 output monitor	0.00 to ± 100.00 (%)	Outputting is possible with (\pm).
db-60	PID4 deviation monitor	0.00 to ± 200.00 (%)	Outputting is possible with (\pm).
db-64	PID feedforward monitor	0.00 to 100.00 (%)	
dC-15	Cooling fin temperature monitor	-20.0 to 200.0 ($^{\circ}$ C)	

Code	Name	Output scale range (Corresponding to 0 to 10 VDC / 0 to 20 mA / 0 to 100%)	Remarks
FA-01	Main speed reference setting or monitor	0.00 to 590.00(Hz)	
FA-02	Sub-speed reference setting or monitor	0.00 to 590.00(Hz)	
FA-15	Torque reference setting or monitor *6)	0.0 to ± 500.0 (%) of torque reference *5)	Outputting is possible with (\pm).
FA-16	Torque bias setting or monitor *6)	0.0 to ± 500.0 (%) of torque reference *5)	Outputting is possible with (\pm).
FA-30	PID1 set-point 1 setting or monitor	0.00 to 100.00 (%) *1)	Outputting is possible with (\pm).
FA-32	PID1 set-point 2 setting or monitor	0.00 to 100.00 (%) *1)	Outputting is possible with (\pm).
FA-34	PID1 set-point 3 setting or monitor	0.00 to 100.00 (%) *1)	Outputting is possible with (\pm).
FA-36	PID2 set-point setting or monitor	0.00 to 100.00 (%) *2)	Outputting is possible with (\pm).
FA-38	PID3 set-point setting or monitor	0.00 to 100.00 (%) *3)	Outputting is possible with (\pm).
FA-40	PID4 set-point setting or monitor	0.00 to 100.00 (%) *4)	Outputting is possible with (\pm).

*1) The data range depends on the [AH-04], [AH-05] and [AH-06].

*2) The data range depends on the [AJ-04], [AJ-05] and [AJ-06].

*3) The data range depends on the [AJ-24], [AJ-25] and [AJ-26].

*4) The data range depends on the [AJ-44], [AJ-45] and [AJ-46].

*5) The torque reference value (100%) is selected with the [HC115] / [HC215]. For details, refer to "12.11.8 Torque Reference Settings for Torque Control".

*6) The torque control related function [FA-16] is valid when the control mode selection [AA121] / [AA221] is 08 (IM-SLV), 09 (IM-0Hz-SLV), or 10 (IM-CLV). And [FA-15] is valid at 08 or 10.

12.25.5 Digital Output Settings

Q

- I want to output monitor data of the inverter to the outside by digital pulse output.
- I want to monitor data using the digital frequency counter.

A

- For the FM output terminal, either PWM output with changing duty ratio or digital frequency output with changing frequency can be selected.



- Note that the maximum output specification of the [FM] output terminal is 3600Hz, so values above that cannot be output.
- When the Analog monitor adjustment mode enable [Cd-10] = 01, the [FM]/[Ao1]/[Ao2] outputs are the fixed values set for [Cd-15]/[Cd-25]/[Cd-35]. Please use this for output adjustment etc.

(Example 1) [Cd-01]=00: PWM output.

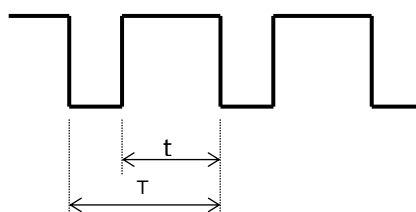

Frequency T: Constant (6.4 ms)
Duty ratio t/T: Changes

(Example 2) [Cd-01]=01: Digital frequency output.

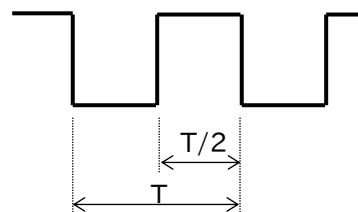

Frequency T: Changes
Duty ratio (approximately 1/2): Fixed

Parameters.

Name	Code	Data range (unit)	Description
[FM] Output wave form selection	[Cd-01]	00	PWM output (Frequency: 6.4 ms)
		01	Digital frequency output
[FM] Output base frequency (at frequency output)	[Cd-02]	0 to 3600 (Hz)	[FM] terminal output frequency in the full scale.
[FM] Output monitor selection	[Cd-03]	Parameter code for "12.25.4 Monitor Data Selectable with Analog or Digital Output"	Sets a parameter code.
Analog monitor adjustment mode enable	[Cd-10]	00	Disable.
		01	Enable. Outputs to terminals output levels in the adjustment mode.
[FM] Output filter time constant	[Cd-11]	1 to 500 (ms)	Filters FM output data.
[FM] Data type selection	[Cd-12]	00	Outputs the absolute value of data.
		01	Outputs the signed value of data.
[FM] Bias adjustment	[Cd-13]	-100.0 to 100.0 (%)	Biases data to adjust Point 0 of data.
[FM] Gain adjustment	[Cd-14]	-1000.0 to 1000.0 (%)	Apply a gain to data to adjust an inclination in data.
Adjustment mode [FM] output level	[Cd-15]	-100.0 to 100.0 (%)	Sets output in the adjustment mode. It selects the maximum output (at 100.0%), the minimum output (at 0.0%) ([Cd-12]=00), or the minimum output (at -100.0%) ([Cd-12]=01).

- [FM] Output wave form selection [Cd-01] is set to 00.
- PWM output adjustment of 0 point by the [FM] bias adjustment [Cd-13] is shown figure below.

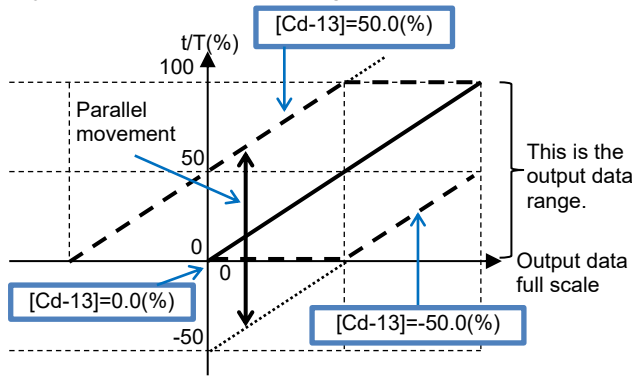

- PWM output adjustment for changing the inclination by the [FM] gain adjustment [Cd-14] is shown figure below.

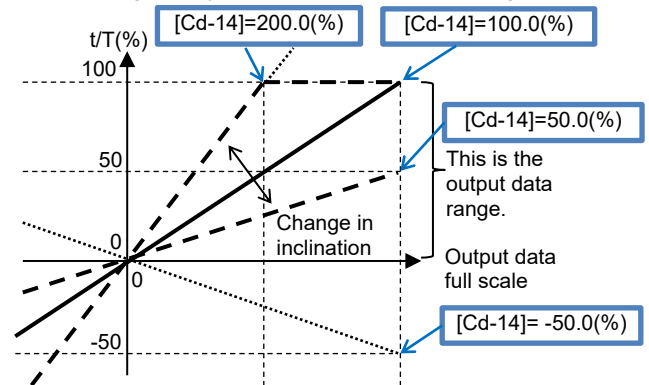

(Ex.1) PWM output of the Output frequency monitor [dA-01].

- To output the maximum frequency as PWM output 100%.
- [Cd-13]=0.0%, [Cd-14]=100.0%.

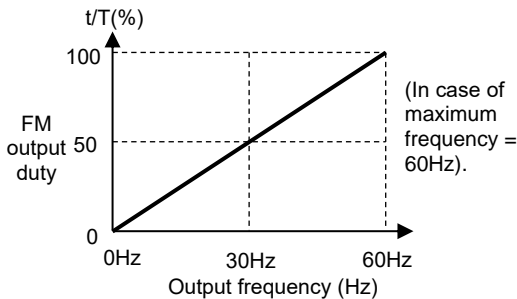

(Ex.2) PWM output of the Output current monitor [dA-02].

- To output the inverter rated current 100% as PWM output 100%. Since the [dA-02] full scale is 200%, so sets the gain setting to 200% to output 100% PWM at the 100% rated current output.
- [Cd-13]=0.0%, [Cd-14]=200.0%.

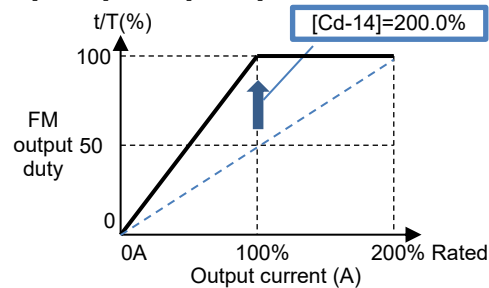

(Ex. 3-1) PWM output of the Output torque monitor [dA-17].

- To output the output torque with signed in the range -200% to +200% as PWM output range from 0 to 100%. In this case, settings of bias [Cd-13] and gain [Cd-14] are so that -200 to 0% and 0 to 200% of output torque become 0 to 50% and 50 to 100% of PWM output respectively. Since the full scale of [dA-17] is $\pm 1000\%$, and shown figure below.

For [Cd-13]: Since the FM output is 0 at the center of the output torque range (-200 to 200%), so the setting is 50%.

For [Cd-14]: Since $[Cd-14] \times 100\% / 1000\% = 50\% / 200\%$, so the setting is 250%.

[Cd-12]=01, [Cd-13]=50.0%, [Cd-14]=250.0%.

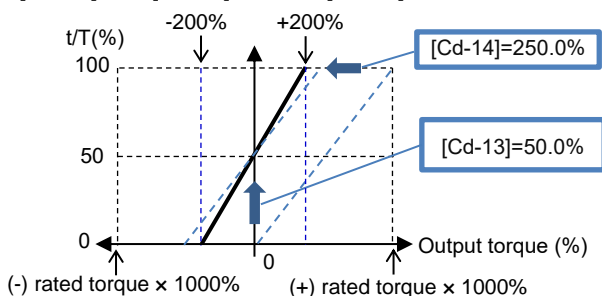

(Ex. 3-2) PWM output of the Output torque monitor [dA-17].

- To output the output torque in the range 0% to $\pm 200\%$ of the absolute value as PWM output range 0 to 100%. In this case, both -200 to 0% and 0 to 200% of output torque are 0 to 100% of PWM output.

For [Cd-13]: Since the FM output 0 = Output torque 0, so the setting is 0%.

For [Cd-14]: Since $[Cd-14] \times 100\% / 1000\% = 100\% / 200\%$, so the setting is 500%.

[Cd-12]=00, [Cd-13]=0.0%, [Cd-14]=500.0%.

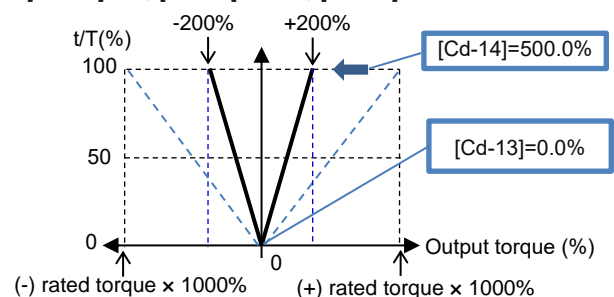

(Ex. 4) PWM output of the Output voltage monitor (RMS) [dA-18].

- To output the output voltage with the rated voltage 100% as the PWM output 100%. Since the [dA-18] full scale is rated output voltage $\times 133\%$, so sets the gain setting to 133% to output 100% PWM at the 100% rated output voltage as shown in the left figure.
- [Cd-13]=0.0%, [Cd-14]=133.0%.

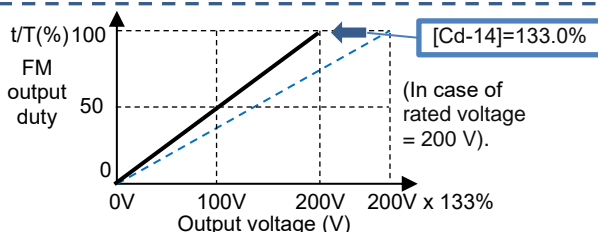

- [FM] Output wave form selection [Cd-01] is set to 01.
- Digital frequency output adjustment of 0 point by the [FM] bias adjustment [Cd-13] is shown figure below.

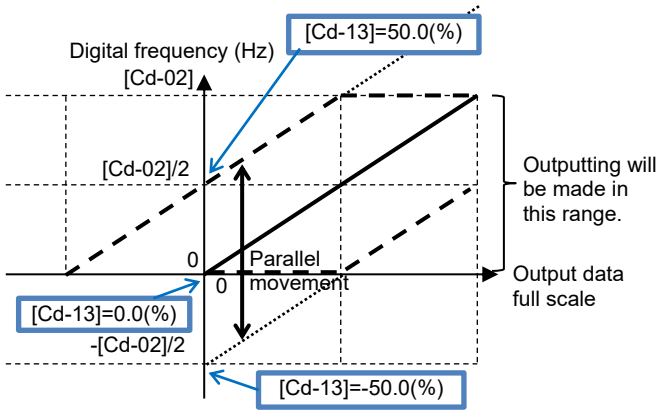

- Digital frequency output adjustment for changing the inclination by the [FM] gain adjustment [Cd-14] is shown figure below.

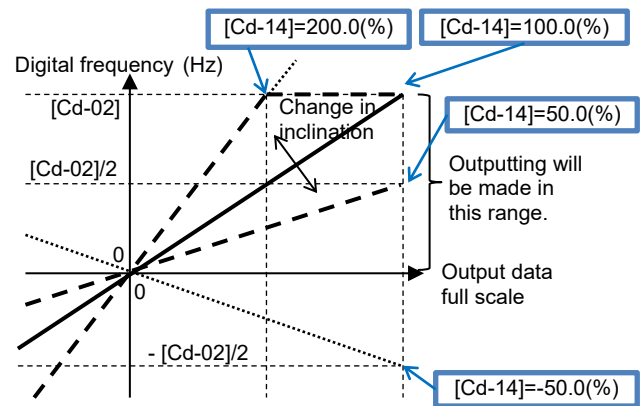

- (Ex.5) Digital frequency output of the Output frequency monitor [dA-01].
- To output the inverter output frequency and the digital frequency output as same frequency and the maximum frequency output as 100%.

When the maximum frequency is 60 Hz, set [Cd-02]=60Hz.
[Cd-13]=0.0%、[Cd-14]=100.0%

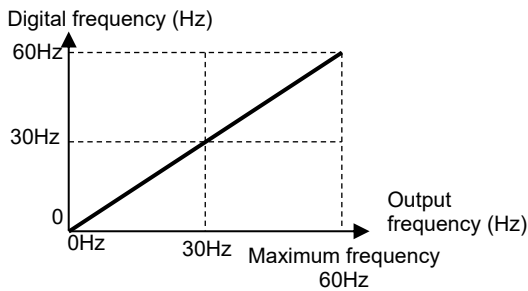

- (Ex.6) Digital frequency output of the Output current monitor [dA-02].
- To output as 1500 Hz digital frequency when the inverter output current is rated current.

Set [Cd-02]=3000Hz.
[Cd-13]=0.0%、[Cd-14]=100.0%

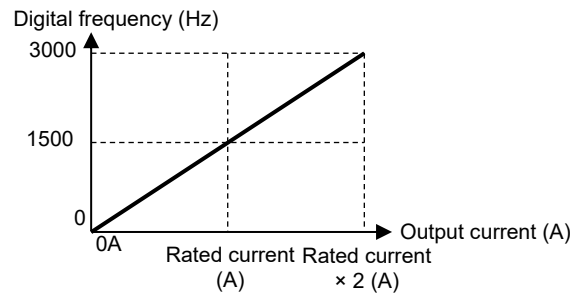

or, Set [Cd-02]=1500Hz.
[Cd-13]=0.0%、[Cd-14]=200.0%

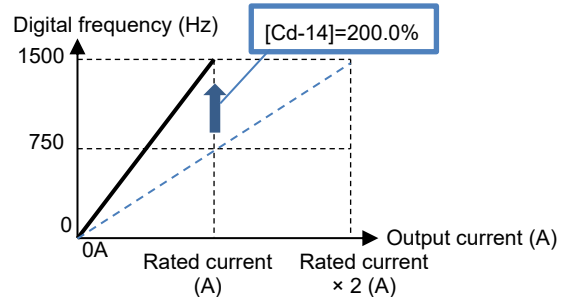

- Analog monitor adjustment mode [FM].
- Setting the Analog monitor adjustment mode enable [Cd-10] to 01 fixes the outputs of the [FM].

- Based on the monitor full scale set in the [FM] output monitor selection [Cd-03], the value set in [Cd-15] is output from the [FM] terminal.

(Ex.) Output the Output current monitor [dA-02] from [FM] as PWM output.
 Adjust to output the inverter rated current 100% as PWM output 100%.
 (The reference point is the inverter rated current.)

Code	Name	Output scale range (Corresponding to 0 to 10 V / 0 to 20 mA)
dA-02	Output current monitor	(0.00 to 2.00) × Inverter rated current (A)

1

Set [Cd-01]=00 and [Cd-03]=(dA-02).
 Setting [Cd-10] to 01, the PWM set in [Cd-15] is output from the [FM] terminal.

2

When outputting the inverter rated current to the reference point, the maximum scale of the output current is the rated current × 2, so first set [Cd-15] to 50.0% (inverter rated current 100%).

By this setting, the [FM] terminal outputs the duty 50% PWM which is the output of rated current (= inverter rated current × 2.00 × 50.0%).

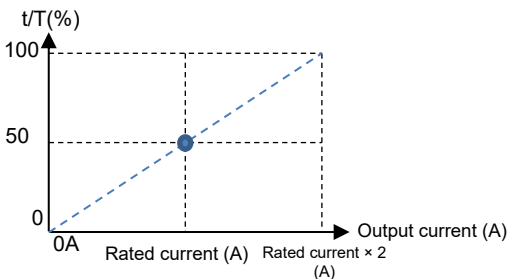

3

Adjust the inclination with [Cd-14].
 Change [Cd-14] to adjust [FM] output is 100% duty PWM output.
 (For example, check while adjusting the range from 190.0% to 210.0%).

[Cd-13]=0.0%、[Cd-14]=200.0%

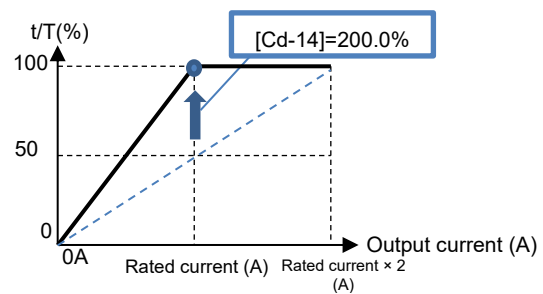

4

After setting [Cd-10] back to 00, adjusted PWM output starts from the [FM] terminal.

12.25.6 Analog Output Settings

Q

- As inverter information, I want to output information externally with a voltage.
- As inverter information, I want to output information externally with a current.

A

- For analog output terminals Ao1 and Ao2, voltage output or current output can be selected by DIP switches SW3 and SW4 on the board.



- For analog outputs, [Ao1] initial setting is voltage output in a range from 0 to 10 V, and [Ao2] initial setting is current output in a range from 4 to 20 mA.
- Operate the DIP switches on the board while the inverter power supply is turned off.
- When [Cd-10]=01 is set, [FM], [Ao1], and [Ao2] respectively perform outputs in accordance with values of [Cd-15], [Cd-25], and [Cd-35].

Parameters.

Name	Code	Data range (unit)	Description
[Ao1] Output monitor selection	[Cd-04]	Parameter code for "12.25.4 Monitor Data Selectable with Analog or Digital Output"	Sets a parameter code.
[Ao2] Output monitor selection	[Cd-05]		
Analog monitor adjustment mode enable	[Cd-10]	00	Disable
		01	Enable: Outputs to terminals output levels in the adjustment mode.
[Ao1] Output filter time constant	[Cd-21]	1 to 500 (ms)	Filters and outputs the selected data.
[Ao1] Data type selection	[Cd-22]	00	Outputs the absolute value of data.
		01	Outputs the signed value of data.
[Ao1] Bias adjustment	[Cd-23]	-100.0 to 100.0 (%)	Biases data to adjust Point 0 of data.
[Ao1] Gain adjustment	[Cd-24]	-1000.0 to 1000.0 (%)	Apply a gain to data to adjust an inclination in data.
Adjustment mode [Ao1] output level	[Cd-25]	-100.0 to 100.0 (%)	Sets output in the adjustment mode. It selects the maximum output (at 100.0%), the minimum output (at 0.0%) ([Cd-22]=00), or the minimum output (at -100.0%) ([Cd-22]=01).
[Ao2] Output filter time constant	[Cd-31]	1 to 500 (ms)	Filters and outputs the selected data.
[Ao2] Data type selection	[Cd-32]	00	Outputs the absolute value of data.
		01	Outputs the signed value of data.
[Ao2] Bias adjustment	[Cd-33]	-100.0 to 100.0 (%)	Biases data to adjust Point 0 of data.
[Ao2] Gain adjustment	[Cd-34] *1)	-1000.0 to 1000.0 (%)	Apply a gain to data to adjust an inclination in data.
Adjustment mode [Ao2] output level	[Cd-35]	-100.0 to 100.0 (%)	Sets output in the adjustment mode. It selects the maximum output (at 100.0%), the minimum output (at 0.0%) ([Cd-32]=00), or the minimum output (at -100.0%) ([Cd-32]=01).

*1) Ver2.02 or later, [Cd-34] initial value is 80%.
In the initial state of factory shipment, the Ao2 analog output is adjusted so that the [dA-01] output frequency from 0 (Hz) to the maximum frequency (Hz) is 4 to 20 mA output.
(Regardless of Version, Fine adjustment may be required due to differences in product parts.)

Before Ver2.01, [Cd-34] initial value is 100%.
When using the analog output monitor from Ao2, be sure to confirm the set values of [Cd-33] and [Cd-34].

Bias adjustment of analog output.

Terminal	Current/voltage	Bias parameter
Ao1	Common to voltage/current	[Cd-23]
Ao2	Common to voltage/current	[Cd-33]

- The bias adjustment to 0 point is shown figure below.

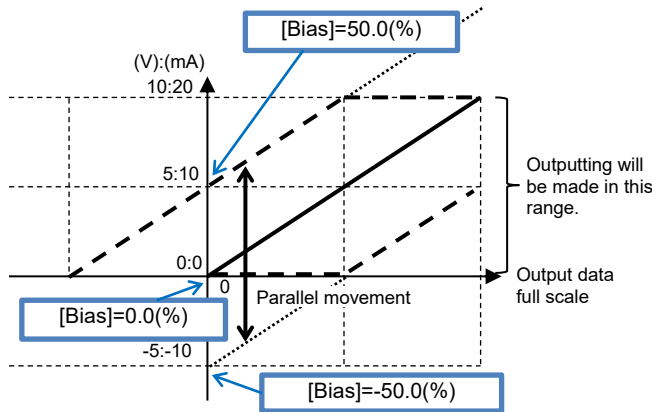

(Ex.1) Output the Output frequency monitor [dA-01] to the Ao1 at voltage range 0 to 10 VDC.

- To output from 0 Hz to maximum frequency (60Hz).
- [Cd-23]=0.0%, [Cd-24]=100.0%

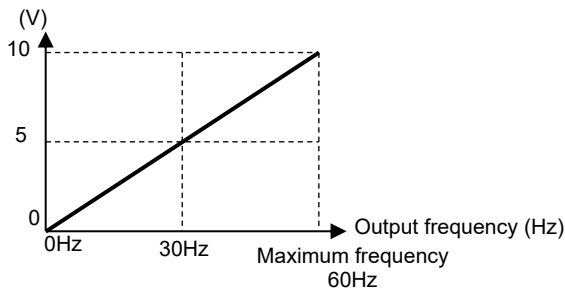

(Ex.3) Output the Output frequency monitor [dA-01] to the Ao1 at current range from 4 to 20 mA.

- To output from 0 Hz to the maximum frequency (50Hz).
- [Cd-23]=20.0%, [Cd-24]=80.0%

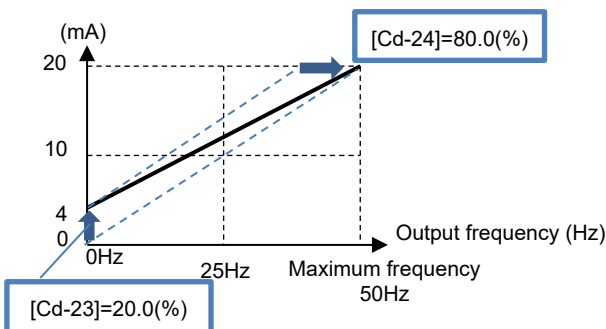

Gain adjustment of analog output.

Terminal	Current/voltage	Gain parameter
Ao1	Common to voltage/current	[Cd-24]
Ao2	Common to voltage/current	[Cd-34]

- The gain adjustment for changing the inclination is shown figure below.

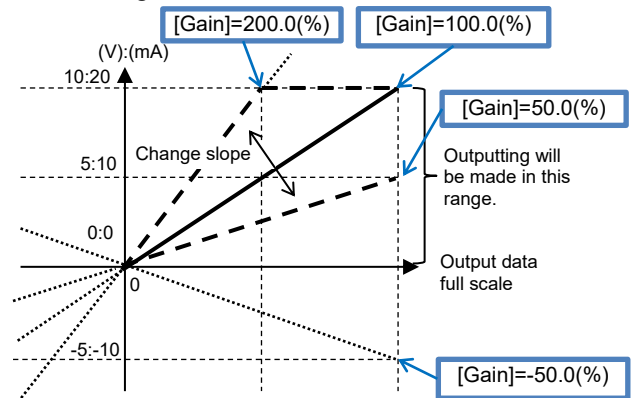

(Ex.2) Output the Output current monitor [dA-02] to the Ao2 at current range 4 to 20 mA.

- To output from 0 A to the inverter rated current.
- [Cd-33]=20.0%, [Cd-34]=160.0%

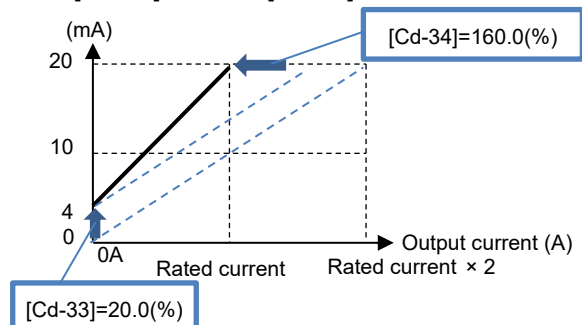

(Ex.4) Output the Output torque monitor [dA-17] to the Ao2 at voltage range from 0 to 10 VDC.

- To output torque from -200% to 200%.
- [Cd-32]=01, [Cd-33]=50.0%, [Cd-34]=250.0%

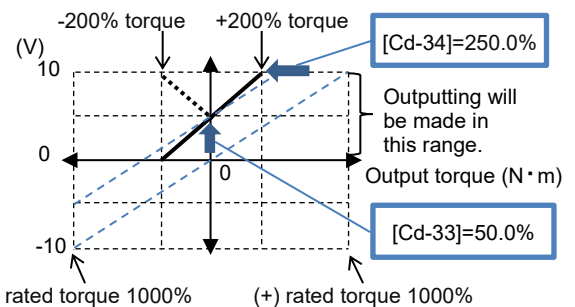

*) If [Cd-32] = 00 is set in the above example, output torque in the negative range of 0 to -200% is output as the corresponding 5 to 10 VDC (dotted line).

- Analog monitor adjustment mode [Ao1]/ [Ao2].
 - Setting the Analog monitor adjustment mode enable [Cd-10] to 01 fixes the outputs of the [Ao1] and [Ao2] output terminals.

- Based on the monitor full scale set in the [Ao1] output monitor selection [Cd-04], the value set in [Cd-25] is output from the [Ao1] terminal.
- Based on the monitor full scale set in the [Ao2] output monitor selection [Cd-05], the value set in [Cd-35] is output from the [Ao1] terminal.

(Ex.) Output the Output current monitor [dA-02] from [Ao1] at the range from 4 to 20 mA.
 Adjust to output 0 to 200% of the inverter rated current within the range of 4 to 20 mA.
 (The reference point is 0 and 200% of the inverter rated current.)

Code	Name	Output scale range (Corresponding to 0 to 10 VDC /0 to 20 mA)
dA-02	Output current monitor	(0.00 to 2.00) × Inverter rated current (A)

1

Check that [SW3] on the board is set to a current of 20 mA, and then turn on the power supply. Set [Cd-04]=[dA-02]. Setting [Cd-10] to 01 and [Cd-25] to 0.0% becomes the output from the [Ao1] terminal to 0 mA.

2

When outputting 4 mA from [Ao1] with the inverter output current 0 A at the reference point, adjust [Cd-23] to about 20.0% and check if 4 mA is output.
 (For example, check while adjusting the range from 15.0% to 25.0%.)

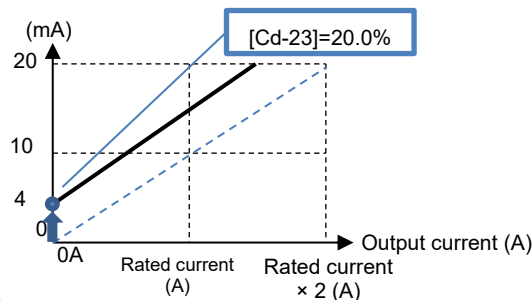

3

Setting [Cd-25] to 100.0% becomes the output from the [Ao1] terminal to approximately 20 mA.

4

Adjust the inclination with [Cd-24]. Change [Cd-24] to adjust just before [Ao1] output begins to drop from 20 mA.
 (For example, check while adjusting the range from 75.0% to 85.0%.)

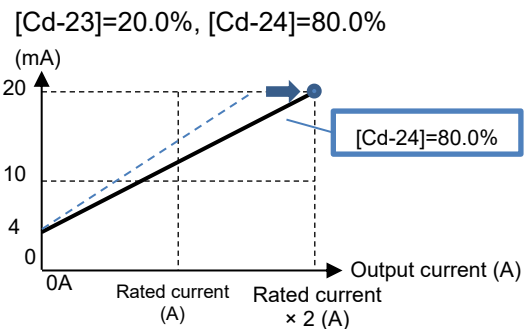

5

After setting [Cd-10] back to 00, adjusted [Ao1] output starts.

■ Analog output settings for P1-AG option.

The analog output function behaviour of Ao3/Ao4 of the optional P1-AG is the same as the analog output Ao1/Ao2. For details, refer to the explanation of related parameters with Ao1/Ao2 read as Ao3/Ao4.

For Ao5 please refer to the following explanation.

For details of installation, wiring and etc., refer to P1-AG Analog Input / Output Option User's Guide NT260*X.

Name	Code	Data range (unit)	Description
[Ao3] Output monitor selection	[oE-50]	Parameter code for "12.25.4 Monitor Data Selectable with Analog or Digital Output "	The operation of Ao3/Ao4 is the same as Ao1/Ao2.
[Ao4] Output monitor selection	[oE-51]		
[Ao5] Output monitor selection	[oE-52]		
[Ao3] Output filter time constant	[oE-56]	1 to 500 (ms)	For details, refer to " Bias adjustment of analog output.", "Gain adjustment of analog output.", "Analog monitor adjustment mode" in this section 12.25.6.
[Ao3] Data type selection	[oE-57]	00(Absolute value)/ 01(Signed value)	
[Ao3] Bias adjustment	[oE-58]	-100.0 to 100.0 (%)	
[Ao3] Gain adjustment	[oE-59]	-1000.0 to 1000.0 (%)	
Adjustment mode [Ao3] output level	[oE-60]	-100.0 to 100.0 (%)	
[Ao4] Output filter time constant	[oE-61]	1 to 500 (ms)	
[Ao4] Data type selection	[oE-62]	00(Absolute value)/ 01(Signed value)	
[Ao4] Bias adjustment	[oE-63]	-100.0 to 100.0 (%)	
[Ao4] Gain adjustment	[oE-64]	-1000.0 to 1000.0 (%)	
Adjustment mode [Ao4] output level	[oE-65]	-100.0 to 100.0 (%)	
[Ao5] Output filter time constant	[oE-66]	1 to 500 (ms)	
[Ao5] Data type selection	[oE-67]	00(Absolute value)/ 01(Signed value)	
[Ao5] Bias adjustment	[oE-68]	-100.0 to 100.0 (%)	
[Ao5] Gain adjustment	[oE-69]	-1000.0 to 1000.0 (%)	
Adjustment mode [Ao5] output level	[oE-70]	-100.0 to 100.0 (%)	

■ Bias adjustment and Gain adjustment for Ao5 analog output of P1-AG.

- When the [Ao5] Data type selection is 00(Absolute value), the negative value is not output, so the Gain and Bias adjustments are the same as Ao1/Ao2.
- The [Ao5] Bias adjustment [oE-68] at 0 point is shown figure below.

- When [Ao5] Data type selection is 01(Signed value), the gain and bias adjustments are as shown below.
- The changing inclination by the [Ao5] Gain adjustment [oE-69] is shown figure below.

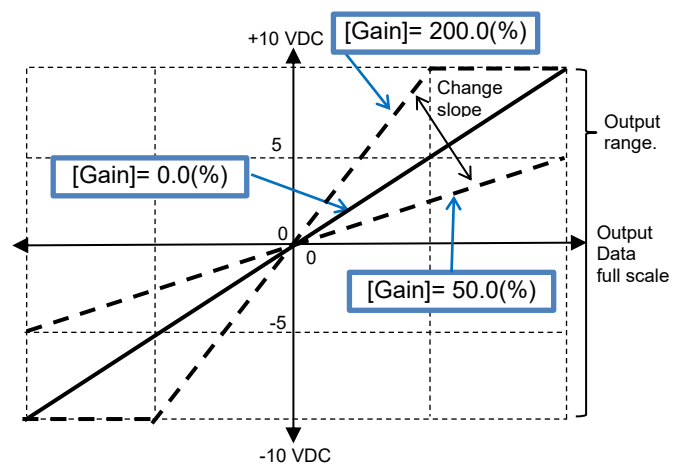
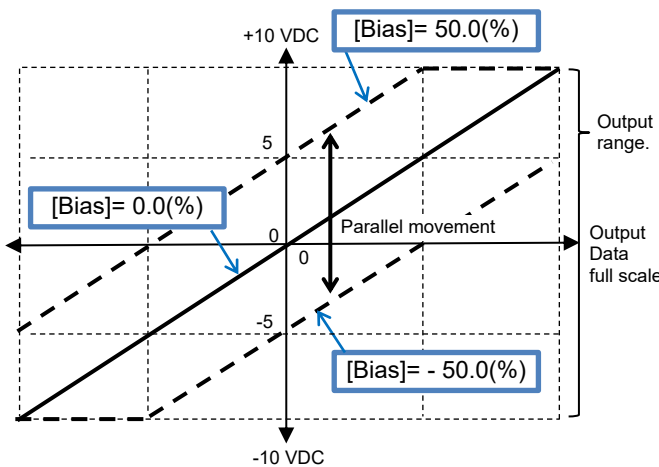

13

Chapter 13 Information Monitor Functions





Contents

- 13.1 What This Chapter Explains 13-1
- 13.2 Checking the Frequency Data 13-2
 - 13.2.1 Monitoring Output Frequency 13-2
 - 13.2.2 Checking Frequency Reference 13-3
 - 13.2.3 Monitoring Converted Frequency 13-4
 - 13.2.4 Monitoring the Motor Detection Speed 13-5
- 13.3 Checking the Acceleration Time or Deceleration Time 13-6
- 13.4 Checking the Rotational Direction 13-7
- 13.5 Checking the Input or Output of Terminals 13-8
 - 13.5.1 Checking the Input Terminals Are Turned ON or Turned OFF 13-8
 - 13.5.2 Checking the Output Terminals Are Turned ON or Turned OFF 13-8
- 13.6 Monitoring Output Current 13-9
- 13.7 Monitoring Output Voltage 13-10
- 13.8 Checking P-N Voltage (Internal DC Voltage) 13-10
- 13.9 Checking the Inverter’s Operating Time and Operation Count 13-11
 - 13.9.1 Checking the Cumulative Running hours 13-11
 - 13.9.2 Checking the Cumulative Power-On Time 13-11
 - 13.9.3 Checking the Total Start-Up Count 13-12
 - 13.9.4 Checking the Total Power-On Count 13-12
- 13.10 Checking the Inverter Temperature 13-13
 - 13.10.1 Checking the Cooling Fin Temperature 13-13
- 13.11 Checking the Inverter Power Consumption 13-14
 - 13.11.1 Checking the Input Power 13-14
 - 13.11.2 Checking the Output Power 13-15
- 13.12 Checking the Result of Life Diagnosis 13-16
 - 13.12.1 Checking the Life Monitor 13-16
 - 13.12.2 Checking the Cumulative Running Time of Cooling Fan 13-17
- 13.13 Checking Electric Thermal Load Factor 13-18
 - 13.13.1 Checking the Load Factor of the Thermal Load Rating (Motor) 13-18
 - 13.13.2 Checking the Load Factor of the Thermal Load Rating (Inverter) 13-18
- 13.14 Checking Load Factor of Braking Resistor 13-19
- 13.15 Checking the State of Mounted Option Slot 13-20
- 13.16 Checking the State of Analog Switch 13-21
- 13.17 Checking the Load Type of Inverter 13-22
- 13.18 Checking the Rated Current of Inverter 13-22
- 13.19 Checking the Run Command Source and Frequency Reference Source 13-23
- 13.20 Checking the State of Inverter 13-24
 - 13.20.1 Iconized Monitors 13-24
- 13.21 Monitoring Analog Input Information 13-26
- 13.22 Monitoring Terminal Block Mounting Status 13-27
- 13.23 Monitoring Functions Described in Other Chapters 13-28

13.1 What This Chapter Explains

This chapter describes various monitor functions of the inverter. Select a monitor function that you want to use and configure it.

Make sure to carefully read “Chapter 1 Safety Instructions/Risks” for safety work.

Symbol	Meanings
	General and troubleshooting questions
	Key points for a solution
	Notes
	Confirmation of procedures

13.2 Checking the Frequency Data

13.2.1 Monitoring Output Frequency



• I want to check output frequency.



• Output frequency operates in such a way that the inverter starts running and follows the frequency reference according to the setting of the acceleration/deceleration time.

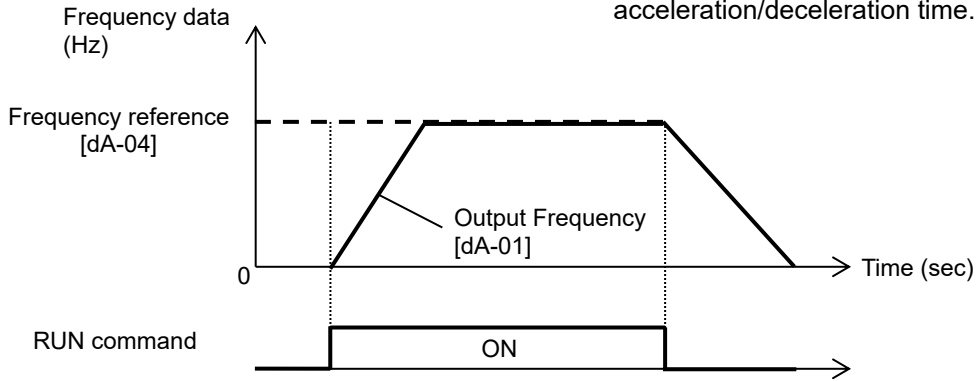

■ Parameter

Name	Code	Data range (unit)	Description
Output frequency monitor	[dA-01]	0.00 to 590.00 (Hz)	Displays output frequency.
Frequency reference monitor (after calculation) *1)	[dA-04]	-590.00 to 590.00 (Hz)	Displays frequency reference.
Output frequency monitor (signed)	[dA-12]	-590.00 to 590.00 (Hz)	Displays output frequency with sign. A forward revolution is indicated with + sign, and a reverse revolution with -.

*1) (After calculation) means after operation such as auxiliary speed, additional frequency, and bias calculation.

13.2.2 Checking Frequency Reference

Q

- I want to check the frequency reference which is entered currently.
- I want to check the main speed and auxiliary speed individually.

A

- The Frequency reference monitor [dA-04] monitors the Frequency reference which is set by selected input source at the moment.
- As for the [FA-01] “Main speed reference setting or monitor”, if the [AA101] “Main speed input source selection, 1st-motor” is set to 07(Operator keypad setting), frequency reference setting value can be changed by using UP/DOWN keys on the Keypad.
- As for the [FA-02] “Sub-speed reference setting or monitor”, if the [AA102] “Sub speed input source selection, 1st-motor” is set to 07 (Operator keypad setting), frequency reference setting value can be changed by using UP/DOWN keys on the Keypad.

!

- If the value of the frequency reference monitor does not change even if the frequency reference is changed, there is a possibility that the unintended frequency reference source is prioritized.
- The frequency reference is influenced by the following functions:
 - Main speed input source selection, 1st-motor [AA101];
 - Sub speed input source selection, 1st-motor [AA102];
 - Jogging command [JG];
 - Multi-speed command [CF1 to CF4 /SF1 to SF7];
 - Main/Sub speed reference change [SCHG];
 - Speed reference calculation symbol selection, 1st-motor [AA105];
 - Force operation [F-OP];
 - Trigger for frequency addition [ADD].
- See “12.4 Selection of Frequency Reference” for details.

Parameter

Name	Code	Data range (unit)	Description
Frequency reference monitor (after calculation) *1)	[dA-04]	-590.00 to 590.00(Hz)	Displays frequency reference. Displays a result of function such as jogging, multi speed, and [F-OP] function operated.
Main speed reference setting or monitor	[FA-01]	0.00 to 590.00(Hz)	Displays the frequency reference selected for the main speed input source selection [AA101].
Sub-speed reference setting or monitor	[FA-02]	Setting : 0.00 to 590.00 (Hz) Monitor : -590.00 to 590.00 (Hz)	Displays the frequency reference selected for the Sub speed input source selection [AA102].

*1) (After calculation) means after operation such as auxiliary speed, additional frequency, and bias calculation.

13.2.3 Monitoring Converted Frequency



- I want to change the displayed frequency reference value.



- In this monitor, gain is applied to the [dA-01] Output frequency monitor.



- On the [dA-06] Output frequency scale conversion monitor, the frequency value obtained by multiplying the coefficient which is set in the [Ab-01] Frequency conversion gain can be shown. Use this method when you want to change the displayed value of data such as motor rotation speed, etc.
- Example of conversion of displayed frequency
 “Output frequency scale conversion monitor [dA-06]” = “Frequency reference (Hz)” x “ Frequency conversion gain [Ab-01]”.

(Example) Displaying the motor rotation speed.
 The relationship of rotation speed and frequency is as shown below:

$$\text{Rotation speed } N \text{ (min}^{-1}\text{)} = (120 \times f \text{ (Hz)})/P(\text{poles})$$

When the motor frequency is 60Hz and the number of poles is 4, the coefficient is 30; hence at 60Hz, if [Ab-01]=30.00, “60×30.0=1800 (min⁻¹)” will be displayed on the monitor.

Table of sample conversions.

Motor frequency (Hz)	Number of motor poles (P)	Coefficient [Ab-01]	Synchronous rotation [min ⁻¹]
50	2	60	3000
50	4	30	1500
50	6	15	750
50	8	7.5	375
60	2	60	3600
60	4	30	1800
60	6	15	900
60	8	7.5	450

Parameter.

Name	Code	Data range (unit)	Description
Output frequency scale conversion monitor	[dA-06]	0.00 to 59000.00	Converted output frequency is displayed.
Frequency conversion gain	[Ab-01]	0.01 to 100.00	Set the gain of frequency conversion monitor.

13.2.4 Monitoring the Motor Detection Speed



- I want to see the rotation frequency information feedback from the motor.



- If the motor is controlled with the encoder feedback, the feedback rotation speed data can be shown as frequency.



- The Detect speed monitor [dA-08] does not work when the encoder feedback function is not used.
- The Detect speed monitor [dA-08] is not displayed correctly when the encoder pulse number and motor pole number settings are incorrect.

Parameters.

Name	Code	Data range (unit)	Description
Detect speed monitor	[dA-08]	-590.00 to 590.00 (Hz)	Displays the feedback speed detection value.
Encoder constant setting (Internal)	[CA-81]	32 to 65535 (pls)	Enabled when the [CA-90] is set to 02.
Pulse train input, target function selection (Internal)	[CA-90]	00	Disable
		01	Pulse train input frequency reference is enabled.
		02	Speed feedback.
		03	Pulse count.
Encoder constant setting (option)	[ob-01]	32 to 65535 (pls)	Set the number of pulses of encoder which is input from P1-FB. It is enabled when [CA-90] is set to other than 02.
Async. Motor number of poles setting, 1st-motor	[Hb103]	0 to 23 (2 to 48 poles)	Set the number of motor poles.

13.3 Checking the Acceleration Time or Deceleration Time



- I want to check the acceleration or deceleration time of the inverter.



- Displays the currently operating accel/decel time when the accel. / decel time is switched by the 2-stage accel/decel function or multi-speed function or when the accel/decel time setting is changed.
- The time that it takes to rise from 0 Hz to the maximum frequency will be displayed as the acceleration time.
- The time that it takes to fall from the maximum frequency to 0 Hz will be displayed as the deceleration time.



- The acceleration time and deceleration time monitors are affected by the following functions:
 - acceleration/deceleration function
 - 2-stage acceleration/deceleration function;
 - Multi-speed function;
 - PID soft-start function;
 - accel/decel cancellation 071[LAC] function;
 - Second setting 024[SET] function;
- The accel/decel time settings are valid only for speed control.
 - If the accel/decel time varies due to torque control, the correct value may not be displayed.
- Even when the accel/decel pattern is changed, the time between 0Hz and the maximum frequency is displayed.

Parameters.

Name	Code	Data range (unit)	Description
Acceleration time setting or monitor	[FA-10]	0.00 to 3600.00 (s)	Monitors the enabled acceleration time.
Deceleration time setting or monitor	[FA-12]	0.00 to 3600.00 (s)	Monitors the enabled deceleration time.

13.4 Checking the Rotational Direction



- I want to check the rotational direction currently used.



- The rotational direction is determined by methods of RUN command and signs of frequency reference.



- If [dA-03] is 1 (0Hz output), the inverter may be in running with 0 Hz due to the DC braking function, forcing function, or Zero-Hz-range sensorless vector control (IM), etc.
- The inverter is in the stop(0) state while the inverter output is shut-off.

Parameters.

Name	Code	Data range (unit)	Description
Rotation direction monitor	[dA-03]	0 (Stop)	Inverter is in stop state.
		1 (0 Hz output)	Inverter is in 0Hz operated state.
		2 (Forward)	Inverter is in forward rotation running.
		3 (Reverse)	Inverter is in reverse rotation running.

13.5 Checking the Input or Output of Terminals

13.5.1 Checking the Input Terminals Are Turned ON or Turned OFF



- I want to know the status of commands currently entered to the input terminals.
- I want to check whether input terminals are disconnected or not.



- The input terminal monitor displays the physical ON (H)/OFF (L) status of terminals.
- A reaction of the input terminal monitor delays according to input terminal response time.
- The input terminal monitor is not affected by setting of a/b contact.



- If the monitor status doesn't change when a terminal is turned ON and OFF, the input wires may be disconnected.
- When the 028[RS] terminal is turned ON, the inverter enters a reset mode; hence the state of input terminal cannot be checked on the input terminal monitor. However, from the fact the inverter enters the reset mode, you know that the terminal is working.

(Example) The state where terminals 4 and 8 are ON.

Monitor	L	L	L	L	L	L	H	L	L	L	
Terminal No.	(B)	(A)	(9)	(8)	(7)	(6)	(5)	(4)	(3)	(2)	(1)

Parameter.

Name	Code	Data range (unit)	Description
Input terminal monitor	[dA-51]	LLLLLLLLLLLL to HHHHHHHHHHHH	Displays the ON/OFF status of input terminals (H: ON; L: OFF).

13.5.2 Checking the Output Terminals Are Turned ON or Turned OFF



- Want to know the status of commands to the output terminals which are outputting now.
- Want to check whether output terminals are disconnected or not.



- The output terminal monitor displays the state of internal functions.
- The output terminal monitor behaves as set for on-delay/off-delay of output terminals.



- If the output terminal status doesn't change when the monitor status changes, the output wires may be disconnected.
- The output terminal monitor is not affected by setting of a/b contact.

(Example) The state where terminals 15 and AL are ON.

Monitor	H	L	H	L	L	L	L
Terminal No.	(AL)	(16)	(15)	(14)	(13)	(12)	(11)

Parameter.

Name	Code	Data range (unit)	Description
Output terminal monitor	[dA-54]	LLLLLLL to HHHHHHH	Displays the ON/OFF status of output terminals (H: ON; L: OFF).

13.6 Monitoring Output Current



- I want to check the effective value of the output current to the motor.
- I want to confirm the output current changing.



- The lower the carrier frequency, the more the value of current of monitor may fluctuate, depending on the PWM output system of the inverter.



- Displays the output current flowing in the motor.

■ Parameter.

Name	Code	Data range (unit)	Description
Output current monitor	[dA-02]	0.00 to 655.35(A) (P1-550L/P1-1320H or smaller) 0.0 to 6553.5(A) (P1-1600H or larger)	Displays the effective value of output current to the motor.

13.7 Monitoring Output Voltage



- I want to check the voltage which is output to the motor.
- I want to confirm the output voltage changing.



- A correct value may not be displayed when the input voltage is low.



- Displays the output voltage which is output to the motor.

Parameter.

Name	Code	Data range (unit)	Description
Output voltage monitor (RMS)	[dA-18]	0.0 to 800.0 (V)	Displays the voltage which is output to the motor.

13.8 Checking P-N Voltage (Internal DC Voltage)



- I want to check the inverter's internal DC voltage.
- I want to check the inverter's internal DC voltage when there is a regenerative voltage from the motor.



- P-N voltage is DC voltage. The overvoltage error [E007] is generated when P-N voltage exceeds approx. 410 VDC in the case of 200V class inverters, and when P-N voltage exceeds approx. 820 VDC in the case of 400V class inverters.



- P-N voltage charged in the main circuit capacitor of inverter can be monitored.

Parameter

Name	Code	Data range (unit)	Description
DC bus voltage monitor (P-N voltage)	[dA-40]	0.0 to 1000.0 (VDC)	Displays the P-N voltage of inverter.

13.9 Checking the Inverter's Operating Time and Operation Count

13.9.1 Checking the Cumulative Running hours



- I want to check how long the inverter has been operated.



- The cumulative RUN time cannot be cleared by the initialization function.



- The Accumulated RUN time monitor [dC-22] displays the cumulative time when the inverter is in running state.

Parameter

Name	Code	Data range (unit)	Description
Accumulated RUN time monitor	[dC-22]	0 to 1000000 [hr]	Data of period that the inverter outputs is stored for monitoring.

13.9.2 Checking the Cumulative Power-On Time



- I want to check the hours when the power of the inverter is turned on.



- The cumulated power-on time cannot be cleared by the initialization function.



- The Accumulated power-on time monitor [dC-24] displays the cumulative time when main power is supplied to the inverter.

Parameter.

Name	Code	Data range (unit)	Description
Accumulated power-on time monitor	[dC-24]	0 to 1000000 [hr]	Data of period that the power of the inverter is turned ON is stored for monitoring.

13.9.3 Checking the Total Start-Up Count



- I want to check how many times the inverter has been running and stopped.



- The cumulated number of starts cannot be cleared by the initialization function.



- The Accumulated number of starts monitor [dC-20] displays the number of times the inverter started running (PWM output to the motor) from the stopped state.

Parameter.

Name	Code	Data range (unit)	Description
Accumulated number of starts monitor	[dC-20]	1 to 65535 (Counts)	Checks the number of times the inverter started running from the stopped state.

13.9.4 Checking the Total Power-On Count



- I want to check the number of times the power supply of the inverter has been turned ON.



- The cumulated number of power-on times cannot be cleared by the initialization function.
- Retry restarts due to instantaneous power failures are not counted.



- The cumulated number of power-on times monitor displays the number of times the power supply of the inverter was turned ON.

Parameter.

Name	Code	Data range (unit)	Description
Accumulated number of power-on times monitor	[dC-21]	1 to 65535 (Counts)	Checks the number of times the power supply for control circuit was turned ON.

13.10 Checking the Inverter Temperature

13.10.1 Checking the Cooling Fin Temperature



- I want to know the temperature of inverter's cooling fin.



- The temperature error [E021] is occurred when the cooling fin temperature exceeds 120°C.



- Cooling fin temperature monitor displays the temperature of inverter's fin.

■ Parameter.

Name	Code	Data range (unit)	Description
Cooling fin temperature monitor	[dC-15]	-20.0 to 200.0 (°C)	Displays the cooling fin temperature

13.11 Checking the Inverter Power Consumption

13.11.1 Checking the Input Power



- I want to know the input power to the inverter.
- I want to know the accumulated input power of inverter.



- On the input power monitor [dA-30], the power which is currently input to the inverter displays.
- On the accumulated input power monitor [dA-32], the cumulative data of input power to the inverter displays.



- The displayed contents can be converted with [UA-13] "Display gain for the accumulated input power monitor".
[dA-32] is
"Calculated input power value (kWh)" / [UA-13].
([UA-13] can be set from 1 to 1000.)
- The accumulated input power value is cleared by setting "01" to [UA-12] "Accumulated input power monitor clear".
- By assigned 039[KHC] accumulation input power clearance to the input terminal, clearing by input terminal is also possible.

Parameters.

Name	Code	Data range (unit)	Description
Input power monitor	[dA-30]	0.00 to 655.35 (kW) (P1-550L/P1-1320H or smaller) 0.0 to 6553.5 (kW) (P1-1600H or larger)	Displays the input power. It changes according to the input power factor.
Accumulated input power monitor	[dA-32]	0.0 to 1000000.0 (kWh)	Displays the cumulative value of input power. It changes according to input power factors.
Accumulated input power monitor clear	[UA-12]	00	Disable.
		01	Clear.
Display gain for the accumulated input power monitor	[UA-13]	1 to 1000	This setting is the gain for [dA-32] display data.
Input terminal function	[CA-01] to [CA-11]	039	039[KHC] Accumulation input power clearance

13.11.2 Checking the Output Power

Q

- I want to know the output power to the motor.
- I want to know the accumulated output power to the motor.

A

- On the output power monitor [dA-34], the power which is currently being output to the motor displays.
- On the accumulated output power monitor [dA-36], the cumulative data of output power to the motor displays.

!

- The displayed contents can be converted with the [UA-15] "Display gain for the accumulated output power monitor".
[dA-36] is
"Calculated output power value (kWh)" / [UA-15].
([UA-15] can be set from 1 to 1000.)
- The accumulated output power value is cleared by setting "01" to [UA-14] "Accumulated output power monitor clear".
- By assigned 040[OKHC] accumulation output power clearance to the input terminal, clearing by input terminal is also possible.

Parameters.

Name	Code	Data range (unit)	Description
Output power monitor	[dA-34]	0.00~655.35(kW) (P1-550L/P1-1320H or smaller) 0.0~6553.5(kW) (P1-1600H or larger)	Displays the output power.
Accumulated output power monitor	[dA-36]	0.0 to 1000000.0 (kWh)	Displays the accumulated value of output power.
Accumulated output power monitor clear	[UA-14]	00	Disable.
		01	Clear.
Display gain for the accumulated output power monitor	[UA-15]	1 to 1000	This setting is the gain for [dA-36] display data.
Input terminal function	[CA-01] to [CA-11]	040	040[OKHC] Accumulation output power clearance.

13.12 Checking the Result of Life Diagnosis

13.12.1 Checking the Life Monitor



- I want to check the life of Inverter.
- I want to know the timing to be maintained.



- The life assessment monitor shows the status of following two items.
 - 1: The lives of electrolytic capacitors on the board (except the main circuit smoothing capacitor.)
 - 2: Reduced rotation speed of the cooling fan.
- As output signals, Capacitor life warning signal (029 [WAC]) and a Cooling-fan speed drop signal (030 [WAF]) can be output.



- The lives of capacitors are calculated once a ten minutes. If the power supply is repeatedly turned ON and OFF faster than this cycle, the inverter will be incapable of diagnosing the lives of capacitors normally.
- If the selection of the cooling fan operation is set to other than 00, the fan will stop automatically depending on the condition. The life diagnosis isn't carried out while the fan is in the automatic stop mode.

Parameters.

Name	Code	Data range (unit)	Description
Life assessment monitor	[dC-16]	LL to HH	The monitors shows H at the end of the life spans. The monitor on the right indicates the lives of the electrolytic capacitors on the circuit board, whereas that on the left indicates the life of the cooling fan.
Capacitor life warning	[CC-01] to [CC-07]	029	029[WAC]: This signal is output when the lives of the electrolytic capacitors on the circuit board are neared.
Cooling-fan speed drop	[CC-01] to [CC-07]	030	030[WAF]: This signal is output when the cooling fan rotation speed is decreased.
Cooling fan control method selection	[bA-70]	00	Always ON
		01	The fan is turned ON during operation and continues rotating for a while after the operation is stopped.
		02	Running depending on the temperature. The fan runs as the fin temperature rises.



- For operation of cooling fan, see “12.18 Controlling the Cooling Fan of the Inverter”.

13.12.2 Checking the Cumulative Running Time of Cooling Fan



- I want to know the operating time of cooling fan.



- The accumulated cooling-fan run time is cleared by setting "01" to [bA-71] "Clear accumulated cooling fan run time monitor".



- The accumulated cooling-fan run time monitor [dC-26] checks the time the cooling fan have operated.
- This monitor can be used as a guid for a replacement of the cooling fan.

■ Parameters.

Name	Code	Data range (unit)	Description
Accumulated cooling-fan run time monitor	[dC-26]	0 to 1000000 (hr)	Measures and displays the duration of time that the cooling fan has been operated.
Clear accumulated cooling fan run time monitor	[bA-71]	00	Disable
		01	Clear

13.13 Checking Electric Thermal Load Factor

13.13.1 Checking the Load Factor of the Thermal Load Rating (Motor)



- I want to check the state of overheat protection of the motor.



- Appropriately perform the basic settings of motor and electric thermal function settings.



- Display the load factor of the electric thermal load rating for the motor. The Motor overload error [E005] is occurred when the load factor exceeds 100%.

Parameter.

Name	Code	Data range (unit)	Description
Electronic thermal load rating monitor (motor)	[dA-42]	0.00 to 100.00 (%)	Displays the load factor of the thermal load rating for the motor.

13.13.2 Checking the Load Factor of the Thermal Load Rating (Inverter)



- I want to check the state of overheat protection of the inverter.



- The SJ-P1 has the electronic thermal function for the inverter and the the electronic thermal function for the motor implemented separately.
- The electronic thermal for the inverter is fixed characteristic and there are no user parameters to change that characteristic.
- The electronic thermal for the inverter follows the ND rated currnt derating regardless of the [Ub-03] load type selection. For details, refer to “20.4 Current Derating Table”.
- If the controller (Inverter) overload error [E039] occurs, refer to “Chapter 18 Tips/FAQ/Troubleshooting”.



- Display the load factor of the electric thermal load rating for the inverter. The controller (Inverter) overload error [E039] is occurred when the load factor exceeds 100%.

Parameter.

Name	Code	Data range (unit)	Description
Electronic thermal load rating monitor (controller)	[dA-43]	0.00 to 100.00 (%)	Displays the load factor of the thermal load rating for the inverter.

13.14 Checking Load Factor of Braking Resistor



- I want to check the use rate of an optional braking resistor.



- Display the use rate of braking resistor circuit (BRD).



- A setting is required for a braking resistor circuit (BRD) to operate. For details, see “12.13.5 Suppressing overvoltage with braking resistor”.
- The braking resistor overload error [E006] is occurred when the [dA-41] BRD load rate exceed the value which is set in the [bA-60] Dynamic brake use ratio.

■ Parameters.

Name	Code	Data range (unit)	Description
BRD load rate monitor	[dA-41]	0.00 to 100.00 (%)	Displays the load ratio of braking resistor.
Dynamic brake use ratio	[bA-60]	0.0 to $10 \times [(bA-63) / (\text{Inverter minimum resistor})]^2$ (%) (Maximum value is 100%) *1)	Sets the maximum use rate of braking resistor.
Dynamic brake resistor value	[bA-63]	Minimum resistor to 600(Ω) *1)	The maximum value of [bA-60] is automatically calculated by setting the connected resistance value.

* 1) The minimum resistance value varies depending on the each model.

13.15 Checking the State of Mounted

Option Slot



- I want to check whether an optional cassette is properly mounted.
- I want to check whether an optional cassette is recognized.



- On the monitor, you can check which optional cassette is mounted and where it is mounted.



- Recognition of an optional cassette is performed in the condition the power supply of the optional cassette has been established.
- If the optional cassette is poorly connected or damaged, it is regarded as in unconnected state.

Parameters.

Name	Code	Data range (unit)	Description
Option slot-1 status	[dA-81]	Option ID *1)	Displays the ID of optional cassette mounted in the option slot 1.
Option slot-2 status	[dA-82]	Option ID *1)	Displays the ID of optional cassette mounted in the option slot 2.
Option slot-3 status	[dA-83]	Option ID *1)	Displays the ID of optional cassette mounted in the option slot 3.

Option ID *1)

ID	Option type	Description
00	No	-
01	P1-EN	Ethernet communication
02	P1-ECT	EtherCAT communication
03	P1-PN	PROFINET communication
05	P1-DN	DeviceNet communication
06	P1-PB	PROFIBUS communication
07	P1-CCL	CC-Link communication
18	P1-AG	Analog Input/Output option
33	P1-FB	Encoder Feedback option (Line driver input) (Can only be mounted in slot 2)
48	P1-FS	Functional safety option (Can only be mounted in slot 3)

13.16 Checking the State of Analog Switch



- I want to check the state of analog voltage/current changeover switches.
- I want to check whether analog input/output terminals are voltage input/output terminals or current input/out terminals.



- You can check the state of analog input/output changeover switches.



- Note that the data cannot be obtained appropriately if the analog input switch selection differs from the actual input, which results in a damage.
- The data cannot be output appropriately if an analog output switch selection differs from the actual output.
- If the data on analog switch monitor does not switch after the switch is switched, check the switch because the switch may not be fully switched or may be damaged.

(Example) For terminals on the inverter, current is enabled only at [Ai2], and voltage is enabled at the other terminals.

For options, current terminal is enabled only at [li5] of [Ai5], and other voltage terminals are enabled.

Monitor	V	V	A	V	V	V	A	V
Terminal No.	(Ao4)	(Ao3)	(Ai5)	(Ai4)	(Ao2)	(Ao1)	(Ai2)	(Ai1)

*) For options, current terminals and voltage terminals are separated. Each terminal is numbered in the order corresponding to "terminal (current terminal/voltage terminal)" as follows: Ao4 (Io4/Vo4), terminal Ao3 (Io3/Vo3), terminal Ai4 (Ii4/Vi4), and terminal Ai5 (Ii5/Vi5).

■Parameter.

Name	Code	Data range (unit)	Description
Analog input/output status monitor	[dA-60]	VVVVVVVV to AAAAAAA	Displays whether an analog input/output terminal is a voltage input/output terminal or a current input/output terminal. [Left side](Ao4(Io4/Vo4))(Ao3(Io3/Vo3))(Ai5(Ii5/Vi5)) (Ai4(Ii4/Vi4))(Ao2)(Ao1)(Ai2)(Ai1) [Right side] V: voltage/A: current

13.17 Checking the Load Type of Inverter



- I want to check the currently selected load type.



- You can check the adopted load rating of inverter.



- You should also check the rated current and current derating characteristics because they vary depending on load type selections.

■ Parameter.

Name	Code	Data range (unit)	Description
Inverter load type status	[dC-01]	00	VLD: Very low duty
		01	LD: Low duty
		02	ND: Normal duty

13.18 Checking the Rated Current of Inverter



- I want to check the present rated current of inverter.



- You can check the adopted rated current of inverter.



- You should also check not only the rated current but also the current derating characteristics because they vary depending on load type selections.

■ Parameter.

Name	Code	Data range (unit)	Description
Rated current monitor	[dC-02]	0.0 to 6553.5 [A]	Displays the rated current adopted to the inverter.

13.19 Checking the Run Command

Source and Frequency

Reference Source



- I want to check if the RUN command input source is correct with what I set.
- I want to check if the frequency reference source is correct with what I set.



- Command and reference sources change depending not only on the setting of parameters but also on the input terminal functions status.
- Inputs from invalidly command and reference sources are ignored.



- You can check the RUN command source and the frequency reference source currently enabled.

Parameters.

Name	Code	Data range (unit)	Description
Main speed input source monitor	[dC-07]	01 to 34	00(Disabled) / 01(Terminal[Ai1]) / 02(Terminal[Ai2]) / 03(Terminal[Ai3]) / 04(Terminal[Ai4]) / 05(Terminal[Ai5]) / 06(Terminal[Ai6]) / 07(Multi-speed 0) / 08(Auxiliary speed) / 09(Multi-speed 1) / 10(Multi-speed 2) / 11(Multi-speed 3) / 12(Multi-speed 4) / 13(Multi-speed 5) / 14(Multi-speed 6) / 15(Multi-speed 7) / 16(Multi-speed 8) / 17(Multi-speed 9) / 18(Multi-speed 10) / 19(Multi-speed 11) / 20(Multi-speed 12) / 21(Multi-speed 13) / 22(Multi-speed 14) / 23(Multi-speed 15) / 24(Jogging) / 25(RS485) / 26(Option-1) / 27(Option-2) / 28(Option-3) / 29(Pulse train input(Internal)) / 30(Pulse train input(Option)) / 31(EzSQ) / 32(PID) / 33(MOP-VR) / 34(AHD retention speed)
Sub speed input source monitor	[dC-08]	00 to 06, 08, 25 to 33	00(Disabled) / 01(Terminal[Ai1]) / 02(Terminal[Ai2]) / 03(Terminal[Ai3]) / 04(Terminal[Ai4]) / 05(Terminal[Ai5]) / 06(Terminal[Ai6]) / 08(Auxiliary speed) / 25(RS485) / 26(Option-1) / 27(Option-2) / 28(Option-3) / 29(Pulse train input(Internal)) / 30(Pulse train input(Option)) / 31(EzSQ) / 32(PID) / 33(MOP-VR)
RUN command input source monitor	[dC-10]	00 to 06	00([FW]/[RV] terminal) / 01(3-wire) / 02(Keypad's RUN key) / 03(RS485) / 04(Option-1) / 05(Option-2) / 06(Option-3)

13.20 Checking the State of Inverter

13.20.1 Iconized Monitors



- The inverter stops and does not operate.
- I want to know the contents of icons.



- For more detail information, refer to “18.5 Troubleshooting for Warning Functions Related Error”.



- Check the current condition of inverter.

Parameters.

Name	Code	Data range (unit)	Description
Icon 2 LIM monitor	[dC-37]	00 to 06	Refer to “18.5.1 Checking the Warning Display”.
Icon 2 ALT monitor	[dC-38]	00 to 04	
Icon 2 RETRY detail monitor	[dC-39]	00 to 02	
Icon 2 NRDY detail monitor	[dC-40]	00 to 09	

■ Icon 2 LIM monitor [dC-37]

Data	Status	Description
00	Other than below.	A state other than those below.
01	Overcurrent suppression.	The overcurrent suppression function is applied due to increased current.
02	Overload restriction.	The overload limiting function is applied due to increased current.
03	Overvoltage suppression.	The overvoltage suppression function is applied due to increased P-N voltage.
04	Torque limitation.	The torque limiting function is applied due to increased current.
05	Frequency limitation.	The frequency is within the upper/lower limit or jump frequency limit.
06	Minimum frequency limitation.	The frequency reference at below the minimum frequency has been given.

■ Icon 2 NRDY detail monitor [dC-40]

Data	Status	Description
00	Other than below.	A state other than those below.
01	Tripped.	A trip has occurred.
02	Power supply error.	Power failure or undervoltage state.
03	Resetting.	Being reset or waiting to cancel reset.
04	STO	STO is enabled.
05	Standby.	Waiting for inverter's internal circuit or internal condition to be stable.
06	Data warning, etc.	A setting inconsistency exists (Warning).
07	EzSQ Sequence error.	Abnormality during a EzSQ operation.
08	Free-run.	Free-run is enabled (free-run operation).
09	Forced stop.	RUN command isn't permitted. Or forced stop is being issued (deceleration stop behavior).

■ Icon 2 ALT monitor [dC-38]

Data	Status	Description
00	Other than below.	A state other than those below.
01	Overload warning.	Current is increased.
02	Motor thermal warning.	The motor thermal load is increased.
03	Inverter thermal warning.	The inverter thermal load is increased.
04	Motor overheat warning.	Motor overheating notice. (A Thermistor must be connected to TH+ and TH- terminals. For details, see "12.7.2 Monitoring of motor temperature".)

■ Icon 2 RETRY detail monitor [dC-39]

Data	Status	Description
00	Other than below.	A state other than those below.
01	Waiting for retry.	Waiting to retry after a trip reset.
02	Waiting for restart.	Waiting to restart.

13.21 Monitoring Analog Input Information



- I want to check how voltage/current of analog input is recognized by the inverter.



- You can monitor the input values for Ai1/Ai2/Ai3 that are currently being input to the inverter's terminal block.
- You can monitor the input values for Ai4/Ai5/Ai6 that are input to the terminal block of an analog extension option.

■ Parameters.

Name	Code	Data range (unit)	Description
Analog input [Ai1] monitor	[dA-61]	0.00 to 100.00 (%)	Monitors analog input values. [Ai1]: 0 to 10 VDC / 0 to 20 mA Switchable. [Ai2]: 0 to 10 VDC / 0 to 20 mA Switchable. [Ai3]: -10 to +10 VDC
Analog input [Ai2] monitor	[dA-62]	0.00 to 100.00 (%)	
Analog input [Ai3] monitor	[dA-63]	-100.00 to 100.00 (%)	
Analog input [Ai4] monitor	[dA-64]	0.00 to 100.00 (%)	Monitors analog input values for an analog extension option. [Ai4(Vi4/Ii4)]: 0 to 10 VDC / 0 to 20 mA Switchable. [Ai5(Vi5/Ii5)]: 0 to 10 VDC / 0 to 20 mA Switchable. [Ai6(Vi6)]: -10 to +10 VDC
Analog input [Ai5] monitor	[dA-65]	0.00 to 100.00 (%)	
Analog input [Ai6] monitor	[dA-66]	-100.00 to 100.00 (%)	

13.22 Monitoring Terminal BlockMounting Status

- I want to check how a terminal block option is recognized by the inverter.



- You can monitor a terminal block option which is currently mounted to the inverter.

■ Parameter.

Name	Code	Data range (unit)	Description
Control terminal type	[dA-50]	00 (standard) / 02 (P1-TM2(Screw type terminal) or P1-TM2R(Screw type terminal (Expanded relay)) / 15 (not connected)	Displays terminal block option types.

13.23 Monitoring Functions

Described in Other Chapters

- The information shown below is provided in the pages shown for reference. Please also read the pages.

Parameter

Parameter	Description	Reference Chapter
See the right column.	Trip history monitor	18.3.1 Checking Trip Information
See the right column.	Retry history monitor	18.3.2 Checking Retry Information
See the right column.	Warning monitor	18.5. Troubleshooting for Warning Functions Related Error
[dE-50]	Warning monitor	18.5.2 Checking Setting Inconsistencies
[dA-14]	Frequency upper limit monitor	12.6.1 Limit Frequency References
[dA-15]	Torque reference monitor (after calculation) *1)	12.11.8 Torque Reference Settings for Torque Control
[dA-17]	Output torque monitor	
[FA-15]	Torque reference setting or monitor	
[FA-16]	Torque bias setting or monitor	12.11.6 Torque Bias Function Settings
[dA-16]	Torque limit monitor	12.11.4 Torque Limit Settings
[dA-20]	Current position monitor	12.17.7 Pulse Train Position Control Settings 12.17.9 Absolute Position Control Settings
[dA-26]	Pulse train position deviation monitor	12.17.7 Pulse Train Position Control Settings
[dA-28]	Pulse count monitor	12.24.6 Checking the Number of Input Pulses
[dA-38]	Motor temperature monitor *2)	12.7.2 Monitoring of Motor Temperature
[dA-45]	Safety STO monitor	21.4 STO Terminal Functions 21.4.7 Status Indication Function
[dA-46]	Safety option hardware monitor	15.7.1 Functional Safety Expansion Option
[dA-47]	Safety option function monitor	
[dA-70]	Pulse train input monitor (internal)	12.4.6 Making Command from Pulse Train Input
[dA-71]	Pulse train input monitor (option)	
[db-30] to [db-64] [FA-30] to [FA-40]	PID function related monitors	12.10.2 PID1 Functions Settings 12.10.5 PID2/PID3/PID4 Functions Settings
[db-01] to [db-23]	EzSQ function related parameters	16.3.3 EzSQ Function Related Parameters
[dC-45]	IM / SM(PMM) monitors	12.9.1 Selection of Control Mode
[dC-50]	Firmware version monitor.	4.3.2 Specification Label

*1) (After calculation) means that it is after calculation such as auxiliary speed or addition frequency and calculation such as torque bias.

*2) This is valid when an NTC type external thermistor is connected. For details, see "12.7.2 Monitoring of Motor Temperature".

14

Chapter 14 RS485 Communication

Contents

- 14.1 What This Chapter Explains 14-1
- 14.2 Modbus-RTU 14-2
 - 14.2.1 Communication Specification 14-2
 - 14.2.2 Wiring and Connection 14-2
 - 14.2.3 Parameters 14-5
 - 14.2.4 Communication Process..... 14-6
- 14.3 Message Structure 14-7
 - 14.3.1 Queries and Responses 14-7
 - 14.3.2 Slave Addresses (Station Numbers)..... 14-7
 - 14.3.3 Function Codes 14-8
 - 14.3.4 Data..... 14-8
 - 14.3.5 Error Check 14-9
 - 14.3.6 Time Required for Communication 14-10
 - 14.3.7 Responses in the Normal Condition 14-10
 - 14.3.8 Responses in the Abnormal Condition 14-10
 - 14.3.9 No Response..... 14-10
- 14.4 Description of Each Function Code 14-11
 - 14.4.1 Read Coils [01h] 14-11
 - 14.4.2 Read Holding Registers [03h]..... 14-12
 - 14.4.3 Write Single Coil [05h] 14-13
 - 14.4.4 Write Single Register [06h]..... 14-14
 - 14.4.5 Diagnostic [08h]..... 14-15
 - 14.4.6 Write Multiple Coils [0Fh]..... 14-16
 - 14.4.7 Write Multiple Registers [10h] 14-17
 - 14.4.8 Read/Write Multiple Registers [17h] 14-18
 - 14.4.9 Exceptional Responses 14-19
 - 14.4.10 Storing a Change Made
to holding register..... 14-20
- 14.5 EzCOM Function 14-21
 - 14.5.1 What is EzCOM 14-21
 - 14.5.2 EzCOM Settings 14-22
 - 14.5.3 EzCOM Operations 14-23
 - 14.5.4 Examples of EzCOM communication 14-24
- 14.6 Lists of Coils and Communication Registers 14-26
 - 14.6.1 Precautions at setting registers and coils ... 14-26
 - 14.6.2 List of coil numbers..... 14-27
 - 14.6.3 List of register numbers 14-28





14.1 What This Chapter Explains

This chapter describes the communication methods operable using RS485 communication. SJ-P1 main units correspond to Modbus-RTU mode in which RS485 is used as the physical layer.

Hitachi's original EzCOM (communication between inverters) function with Modbus protocol is also available.

Select a communication function that you want to use and configure it.

Make sure to carefully read "Chapter 1 Safety Instructions/Risks" for safety work.

Symbol	Meanings
	General and troubleshooting questions
	Key points for a solution
	Notes
	Confirmation of procedures

14.2 Modbus-RTU

14.2.1 Communication Specification

- Modbus-RTU is used as communication method.

Item	Modbus-RTU Mode	Remarks
Transmission speed	2400/4800/9600/19.2k/38.4k/57.6k/76.8k/115.2k bps	Sets using a parameter.
Communication method	Half duplex communication method	
Synchronous mode	Non-synchronous mode	
Transmission code	Binary	
Transmission method	Transmission from a low-order bit	
Applicable interface	RS-485	
Data bit length	8 bits	
Parity	No / Even / Odd	Sets using a parameter.
Stop bit length	1/2 bits	Sets using a parameter.
Start mode	Half side start method by command from external control equipment.	
Waiting time	0 to 1000[ms]	Sets using a parameter.
Connection form	1:N (N=Maximum 32) (Up to 247 units can be connected with a repeater unit)	Sets using a parameter.
Error check	Overrun / Framing / CRC-16 / Horizontal parity	

14.2.2 Wiring and Connection

■ Wiring location.

For RS485 communication, connect the external control equipment to the terminals shown in the table below.



- For wiring details, see "7.7.2 Wiring to the Control Circuit Terminal Block".

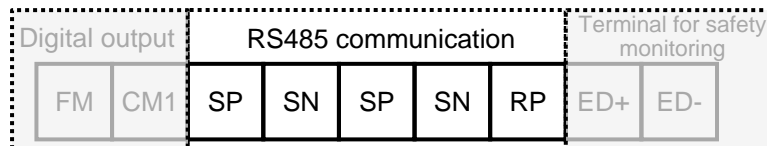

Terminal symbol	Description
SP	Sending/receiving + side
SN	Sending/receiving - side
RP	Enable termination resistor terminal
(SN)	Enable termination resistor terminal
(CM1)	Signal ground

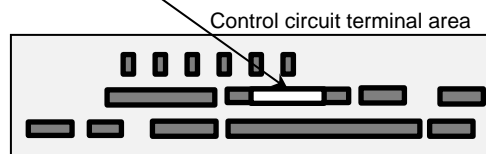

■ Connection and cable used

- An example of RS485 communication wiring connection is shown below.
Connect each inverter in parallel as shown below.
- For the communication cable, use a shielded 3-wire cable that includes a twisted pair for communication and a ground connection.
- Connects the signal ground (SG) of external control equipment to CM1 of the control circuit terminal block of the inverter.
- Be sure to short-circuit between RP and SN at the terminal end inverter.
When RP and SN are short-circuited, the terminating resistor in the control terminal board becomes effective, and the communication error is prevented by suppressing the signal reflection. (Even if there is only one inverter that performs RS485 communication, short between RP and SN.)

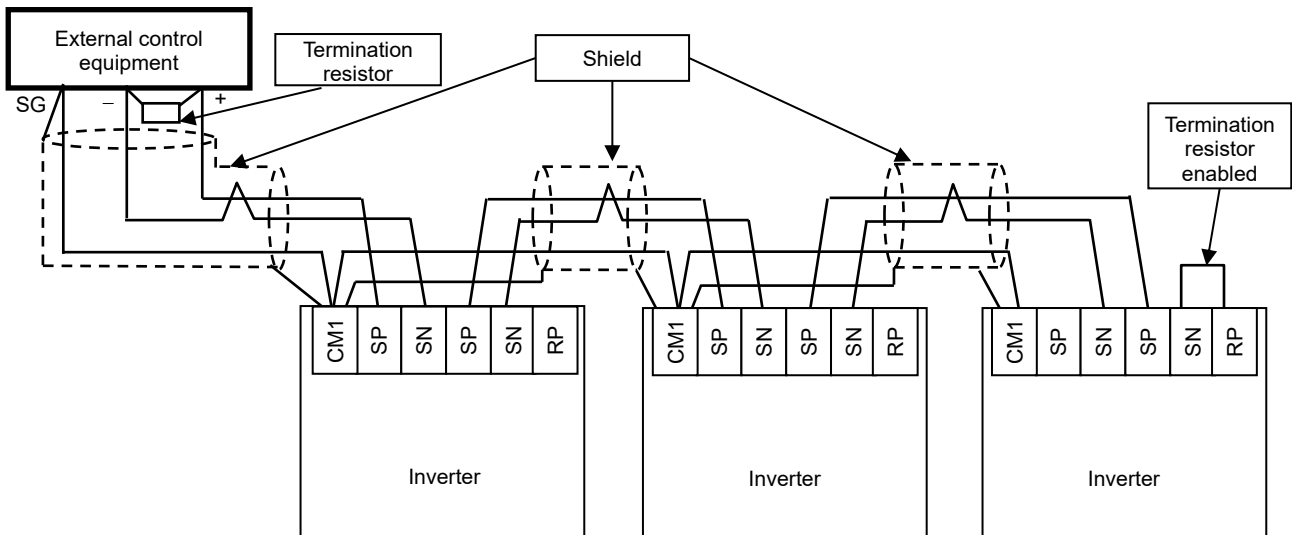

- Wire the signal ground (SG) of external control equipment and CM1 of the control circuit terminal block of the inverter.
Communication may be possible even with a 2-wire twisted pair cable, but it is not recommended. It increases the possibility of communication error due to noise.
- Normally, connect the shield and CM1 as shown above.
If a communication error occurs due to noise, disconnecting the shield and CM1 may improve the communication noise.
Please connect or disconnect the shields and each CM1 depending on the situation.
- Separate the communication cables from the high-voltage wiring such as power cables and alarm relay wiring, and be sure not to lay them in parallel.

(memo)

14.2.3 Parameters

■ Parameter settings.

RS485 communication requires the following settings.

Item	Parameter	Data	Description
RS485 communication baud rate selection	[CF-01]	03	2400bps
		04	4800bps
		05	9600bps
		06	19.2kbps
		07	38.4kbps
		08	57.6kbps
		09	76.8kbps
		10	115.2kbps
RS485 communication node address	[CF-02]	1 to 247	Assigns inverter station numbers. This is to be set in controlling multiple inverters simultaneously.
RS485 communication parity selection	[CF-03]	00	No Parity
		01	Even parity
		02	Odd parity
RS485 communication stop bit selection	[CF-04]	01	1 bit
		02	2 bits
RS485 communication error selection	[CF-05]	00	Error
		01	Error output after Deceleration stop
		02	Ignore
		03	Free run stop
		04	Decelration stop
RS485 communication timeout setting	[CF-06]	0.00 to 100.00 (s)	Determination time for communication disconnection. When communication is lost longer than the determination time, the RS485 error [E041] will be occurred.
RS485 communication wait time setting	[CF-07]	0 to 1000 (ms)	The time until the inverter replies.
RS485 communication mode selection	[CF-08]	1	Modbus-RTU mode
		2	Communication between inverters (EzCOM)
		3	Communication between inverters (EzCOM Administrator)
Register data conversion function (A,V↔%) *1)	[CF-11]	00	Current/Voltage response unit is (A, V)
		01	Current/voltage unit is (%) of rated value
Output terminal [11] to [16], [AL] function	[CC-01] to [CC-07]	049	By assigning 049 [NDc] to the output terminal, the [NDc] signal turns ON when a communication disconnection occurs, and turns OFF when the error is released.

*1) Refer to the register number list in this chapter for the corresponding data.

14.2.4 Communication Process

A

■ Communication process

Communication between external control equipment and the inverter is carried out in the following process:

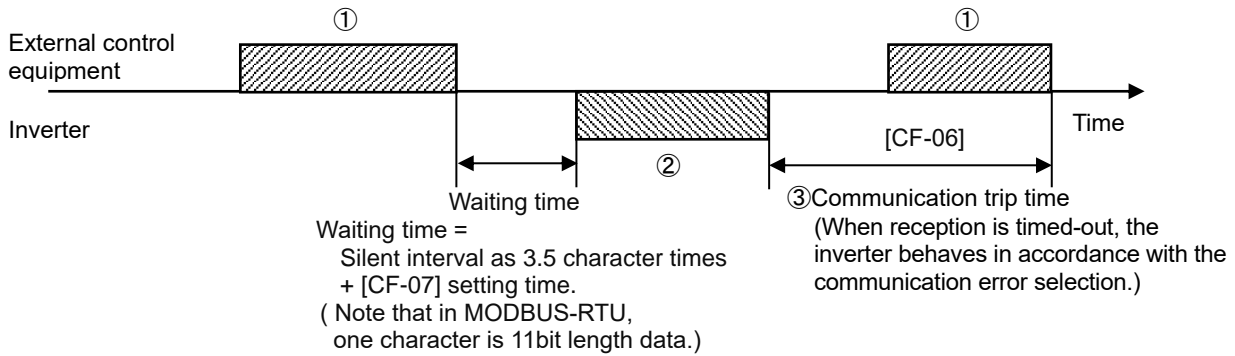

- ①Frame sent from external control equipment to the inverter (query)
- ②Frame returned from the inverter to external control equipment (response)
- ③After the inverter sends a response, if a query from the external control equipment is not completely received within the time set in [CF-06] (communication timeout time), the inverter will be in the condition of receiving the head data again. During this, the inverter will be in a no response condition and will behave as set in the communication error selection. For more details, see the following.

Monitoring of reception timeout begins following the completion of first transmission after the power supply is turned ON or reset. As long as transmission and reception is not performed, reception timeout will not occur.

A response from the inverter (frame ②) is output as a reply after the inverter receives a query (frame ①) and hence is not output actively. Silent interval time of 3.5 characters is always inserted between ① and ②. So, the waiting time is the silent interval + [CF-07] setting time.

■ Parameter.

Item	Parameter	Data	Description
RS485 communication error selection	[CF-05]	00 : Error	Error [E041] occurs after reception timeout.
		01 : Error output after Deceleration stop	Deceleration stop after reception timeout. Trip with error [E041] after stopping.
		02 : Ignore	Timeout error is invalid.
		03 : Free run stop	Free run stops when timeout occurs, but error [E041] does not occur.
		04 : Deceleration stop	Deceleration stop when timeout occurs, but error [E041] does not occur.
RS485 communication timeout setting	[CF-06]	0.00 to 100.00 (s)	The time until reception timeout.
RS485 communication wait time setting	[CF-07]	0 to 1000 (ms)	Determines the waiting time until a response is started after reception is completed. The actual waiting time is the addition of the silent interval of 3.5 characters and this set time. (Note that in MODBUS-RTU, one character is 11bit length data.)

14.3 Message Structure

14.3.1 Queries and Responses

- A command message sent from the master to a slave is called a “query”, and an answering message from a slave is called “response”.

Transmission formats of queries and responses are shown below:

Query
Slave address
Function code
Query data
Error check (CRC-16)

Rspose
Slave address for checking
Function code for checking
Answering data
Error check (CRC-16)

14.3.2 Slave Addresses (Station Numbers)

- A slave address is a number from 1 to 247 which is set in each inverter (slave) in advance. (Only the inverter having the address matching the query’s slave address will take the query.)
- If the master designate “0” to the slave address of transmission destination, it is a broadcast transmission to all stations. Under the broadcasting mode, all slaves receive data but do not return responses.

- Under the broadcasting mode, data readout and loopback cannot be executed.
- Although in the Modbus specification, slave addresses from 1 to 247 are used. If using number 250 to 254 as slave addresses, the master station can execute a broadcasting only to the specific slave addresses shown below table. (In this case, the slaves do not return responses. And this function is valid only for Register Write commands (05h, 06h, 0Fh, 10h).)

Slave Address	Transmission Destination
250 (FAh)	Simultaneous broadcasting to slave addresses 01 to 09.
251 (FBh)	Simultaneous broadcasting to slave addresses 10 to 19.
252 (FCh)	Simultaneous broadcasting to slave addresses 20 to 29.
253 (FDh)	Simultaneous broadcasting to slave addresses 30 to 39.
254 (FEh)	Simultaneous broadcasting to slave addresses 40 to 247.

14.3.3 Function Codes

- Specify functions the inverter executes using function codes.

Corresponding function codes are shown below:

■ Function code.

Function Code	Function	Max. Data Bytes Handled by 1 Message	Max. Number of Data Handled by 1 Message
01h	Read Coils.	4	32 coils (bitwise)
03h	Read Holding Registers.	32	16 registers (in bytes)
05h	Write Single Coil.	2	1 coil (bitwise)
06h	Write Single Register.	2	1 register (in bytes)
08h	Diagnostics	-	-
0Fh	Write Multiple Coils.	4	32 coils (bitwise)
10h	Write Multiple Registers.	32	16 registers (in bytes)
17h	Read/Write Multiple Registers.	32 / 32	16 / 16 registers (in bytes)

14.3.4 Data

- The data related to the function code are transmitted.
- The inverter corresponds to the data formats shown below among data used in Modbus.
- Transmission formats of data vary depending on function codes.

Data Name	Description
Coil	Writable/readable binary data (1 bit long)
Holding Register	Writable/readable 16 bits long data

14.3.5 Error Check

- To check errors in Modbus-RTU, use CRC (Cyclic Redundancy Check).
- To generate a CRC code, use the generating polynomial for CRC-16 ($X^{16}+X^{15}+X^2+1$).
- CRC codes are 16 bits data generated for a block with arbitrary data length in 8-bit unit.

Example of procedure for calculating CRC-16.

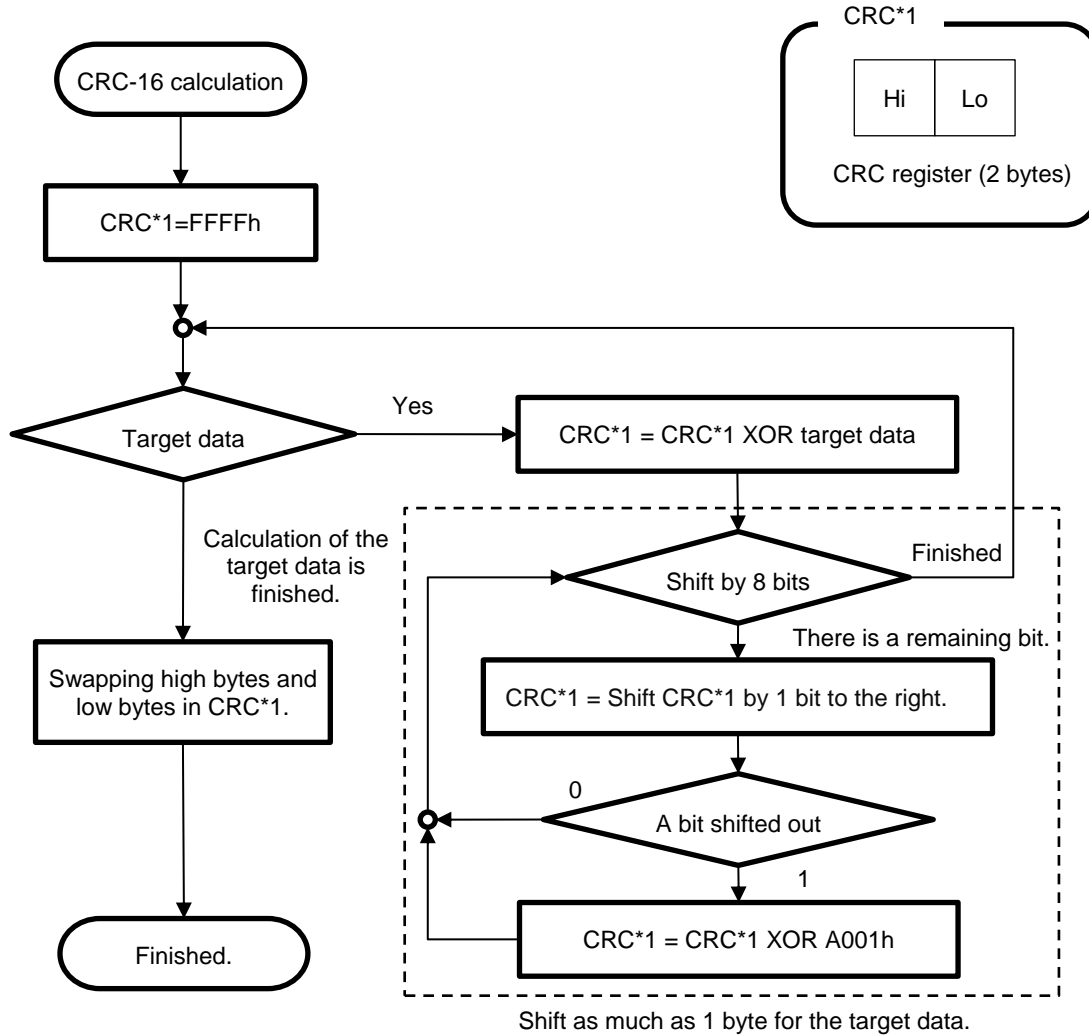

14.3.6 Time Required for Communication

- The inverter's response after it receives a query is equal to silent interval plus [CF-07] setting value plus processing time for creating response.

14.3.7 Responses in the Normal Condition

- A response is returned in accordance with the format for each query defined in "14.4 Description of Each Function Code".

14.3.8 Responses in the Abnormal Condition

- When there is a failure (excluding communication error) in the content of a query, the inverter returns an exceptional response without executing any action requested by the query.
- For error determination, check the function code of the response. The function code of the exceptional response is the value obtained by adding 80h to the function code of the query.

- When transmitting the next query to the inverter after receiving a response from the inverter, make sure to provide an interval equal to the silent interval of [at least 3.5 characters] or more.

- Field composition for exceptional response

Slave address
Function code
Exception code
CRC-16

- For more details of errors, see "14.4.9 Exceptional Responses".

14.3.9 No Response

- The inverter ignores a query and returns no response in the following conditions:
 - (1) A broadcast (query with slave address "0") is received.
 - (2) A communication error is detected during a query reception processing.
 - (3) The query's slave address doesn't match the slave address set in the inverter.
 - (4) The time interval between data constituting a message is 3.5 characters or less.
 - (5) The data of query is in the wrong length.
 - (6) The reception interval within frame exceeds 1.5 character.
 - (7) An error check code of query does not match (CRC error).
 - (8) A simultaneous broadcasting by group (query with slave address from 250 to 254) is received.



- Provide the master with a timer for monitoring responses, then if a response is not returned within the time, transmit the same query again.

14.4 Description of Each Function Code

14.4.1 Read Coils [01h]

- Read out the state of coil (ON/OFF).

(Example)

To read out the input terminal functions from 1 to 6 of the inverter with slave address 8, the state of input terminals are as shown in the right table.

- Coils 13 and 14 are OFF.

Input terminal No.	1	2	3	4	5	6
Coil No.	7	8	9	10	11	12
Terminal state	ON	ON	ON	OFF	ON	OFF

Query

Field Name	Example (HEX)
1 Slave address *1)	08
2 Function code	01
3 Coil starting No. (high) *2)	00
4 Coil starting No. (low) *2)	06
5 Number of coils (high) *3)	00
6 Number of coils (low) *3)	06
7 CRC-16 (high)	5C
8 CRC-16 (low)	90

Response

Field Name	Example (HEX)
1 Slave address	08
2 Function code	01
3 Data bytes	01
4 Read coil data *4)	17
5 CRC-16 (high)	12
6 CRC-16 (low)	1A



- *1) A broadcasting cannot be executed.
- *2) Note that the value of starting number is one less than the actual number. Specify the value of "(Coil No.) -1".
- *3) Where the number of readout coils is specified to value 0 or value exceeding 32, error code "03h" is returned.
- *4) Data as much as the number of data bytes is transferred.



- Data received as a response indicates the state of coils 7 to 14. The data "17h = 00010111b" received here is read as shown below, letting coil 7 be the LSB.

When the coil state readout command cannot be executed normally, see "14.4.9 Exceptional Responses".

Coil number	14	13	12	11	10	9	8	7
Coil state	OFF	OFF	OFF	ON	OFF	ON	ON	ON
17h	0	0	0	1	0	1	1	1

In the last coil data, if the readout coil data extends to the outside the range of defined coil, the coil data beyond the range is transmitted as "0".

14.4.2 Read Holding Registers [03h]

- Read out the contents of consecutive holding registers as much as specified, from the specified holding register addresses.

(Example)

To read out a past trip history from the inverter with slave address 5.

(To read out the factors and output frequency of trip monitor.)

	Trip monitor 1 (factor)	Trip monitor 1 (output frequency)
Register No.	03E9h	03EAh, 03EBh
Data	Overvoltage [E007] =(0007h)	60.00Hz = (0000h, 1770h)

Query

Field Name	Example (HEX)
1 Slave address *1)	05
2 Function code	03
3 Register starting No. (high) *2)	03
4 Register starting No. (low) *2)	E8
5 The number of registers (high)	00
6 The number of registers (low)	03
7 CRC-16 (high)	84
8 CRC-16 (low)	3F

Response

Field Name	Example (HEX)
1 Slave address	05
2 Function code	03
3 Data bytes *3)	06
4 Readout data 0 (high)	00
5 Readout data 0 (low)	07
6 Readout data +1 (high)	00
7 Readout data +1 (low)	00
8 Readout data +2 (high)	17
9 Readout data +2 (low)	70
10 CRC-16 (high)	A8
11 CRC-16 (low)	61



- *1) A broadcasting cannot be executed.
- *2) Note that the value of starting number is one less than the actual number. Specify the value of "(Register No.) -1".
- *3) Data as much as the number of data bytes is transferred. In this example, two holding registers are returned; hence 4 bytes.



- The data received as a response is read as shown below.

Response buffer	4	5	6	7	8	9
Register starting No.	+0 (hi)	+0 (lo)	+1 (hi)	+1 (lo)	+2 (hi)	+2 (lo)
Response data	00h	07h	00h	00h	17h	70h
Trip description	Overvoltage trip (0007h)		Trip frequency 60.00Hz (00001770h)			

- When a readout of holding register contents cannot be executed normally, see "14.4.9 Exceptional Responses".

14.4.3 Write Single Coil [05h]

- Perform writing to a coil.
Coil states change as shown in the table at the right.

(Example)

To give a RUN command to the inverter with slave address 10.

- To drive the inverter via Modbus command, it is necessary to set the RUN command input source selection [AA111] to 03.
- Coil No. for RUN command is "1".

	Coil state	
	OFF→ON	ON→OFF
Data to be changed (high)	FFh	00h
Data to be changed (low)	00h	00h

Query

Field Name	Example (HEX)
1 Slave address *1)	0A
2 Function code	05
3 Coil starting No. (high) *2)	00
4 Coil starting No. (low) *2)	00
5 Write coil data (high)	FF
6 Write coil data (low)	00
7 CRC-16 (high)	8D
8 CRC-16 (low)	41

Response

Field Name	Example (HEX)
1 Slave address	0A
2 Function code	05
3 Coil starting No. (high)	00
4 Coil starting No. (low)	00
5 Write coil data (high)	FF
6 Write coil data (low)	00
7 CRC-16 (high)	8D
8 CRC-16 (low)	41



- *1) When a broadcasting is performed, a response is not returned.
- *2) Note that the shown value is one less than starting number. For coil No. 0001, specify 0000(=0001-1).



- When a writing to a coil cannot be executed normally, see "14.4.9 Exceptional Responses".

14.4.4 Write Single Register [06h]

- Perform a writing to the specified holding register.

(Example)

Write 50 Hz to the Multi-speed 0 setting [Ab110] of the slave address 1 inverter.

- In order to set 50 Hz to the Multi-speed 0 setting [Ab110], because of the data resolution of the holding register "2F4Eh" is 0.01Hz, so set "5000 (1388h)".

Query		
	Field Name	Example (HEX)
1	Slave address *1)	01
2	Function code	06
3	Register starting No. (high)	2F
4	Register starting No. (low)	4D
5	Write data (high)	13
6	Write data (low)	88
7	CRC-16 (high)	1C
8	CRC-16 (low)	5F

Response		
	Field Name	Example (HEX)
1	Slave address	01
2	Function code	06
3	Register starting No. (high)	2F
4	Register starting No. (low)	4D
5	Write data (high)	13
6	Write data (low)	88
7	CRC-16 (high)	1C
8	CRC-16 (low)	5F



- *1) When a broadcasting is performed, a response is not returned.

- *3) Note that the starting address of [Ab110] holding register is "2F4Dh", which is one less than the register No. "2F4Eh". The value obtained by subtracting one from the register No. is the register address.



- When a writing to a holding register cannot be executed normally, see "14.4.9 Exceptional Responses".

14.4.5 Diagnostic [08h]

- Use this test for a communication check between the master and slaves. For test data, arbitrary values can be used.

(Example)

To perform a loopback test on the inverter with slave address 1.

Query

	Field Name	Example (HEX)
1	Slave address *1)	01
2	Function code	08
3	Diagnostic sub code (high)	00
4	Diagnostic sub code (low)	00
5	Data (high)	Arbitrary
6	Data (low)	Arbitrary
7	CRC-16 (high)	CRC
8	CRC-16 (low)	CRC

Response

	Field Name	Example (HEX)
1	Slave address	01
2	Function code	08
3	Diagnostic sub code (high)	00
4	Diagnostic sub code (low)	00
5	Data (high)	Arbitrary
6	Data (low)	Arbitrary
7	CRC-16 (high)	CRC
8	CRC-16 (low)	CRC



*1) A broadcasting cannot be executed.



- Diagnostic sub codes correspond to query data echo (00h, 00h) only and not to other commands.

14.4.6 Write Multiple Coils [0Fh]

- Rewrite consecutive multiple coils.

(Example)

To change the state of input terminal functions from 1 to 6 of the inverter with slave address 5.

The state of input terminals are as shown below.

Input terminal No.	1	2	3	4	5	6
Coil No.	7	8	9	10	11	12
Terminal state	ON	ON	ON	OFF	ON	OFF

Query

Field Name	Example (HEX)
1 Slave address *1)	05
2 Function code	0F
3 Coil starting No. (high) *2)	00
4 Coil starting No. (low) *2)	06
5 Number of coils (high)	00
6 Number of coils (low)	06
7 Bytes *3)	02
8 Write coil data (high) *3)	17
9 Write coil data (low) *3)	00
10 CRC-16 (high)	DB
11 CRC-16 (low)	3E

Response

Field Name	Example (HEX)
1 Slave address	05
2 Function code	0F
3 Coil starting No. (high)	00
4 Coil starting No. (low)	06
5 Number of coils (high)	00
6 Number of coils (low)	06
7 CRC-16 (high)	34
8 CRC-16 (low)	4C



- *1) When a broadcasting is performed, a response is not returned.
- *2) Note that the value of starting number is one less than the No.
- *3) Even when the number of bytes required to be changed is odd, add 1 to the number to make it even because the data to be changed will consist of higher order and lower order bytes as a set.



- When a writing to multiple coils cannot be executed normally, see "14.4.9 Exceptional Responses".

14.4.7 Write Multiple Registers [10h]

- Rewrite consecutive multiple registers.

(Example)

Write 3,000 sec to the Acceleration time setting setting [FA-10] of the slave address 1 inverter.

- In order to set 3,000 sec to the Acceleration time setting [FA-10], because of the data resolution of the holding register "2B02h,2B03h" is 0.01 sec, so set "300,000 (493E0h)".

Query		
	Field Name	Example (HEX)
1	Slave address *1)	01
2	Function code	10
3	Starting address (high) *2)	2B
4	Starting address (low) *2)	01
5	The number of registers (high)	00
6	The number of registers (low)	02
7	Bytes *3)	04
8	Write register data 1 (high)	00
9	Write register data 1 (low)	04
10	Write register data 2 (high)	93
11	Write register data 2 (low)	E0
12	CRC-16 (high)	F4
13	CRC-16 (low)	2B

Response		
	Field Name	Example (HEX)
1	Slave address	01
2	Function code	10
3	Starting address (high)	2B
4	Starting address (low)	01
5	The number of registers (high)	00
6	The number of registers (low)	02
7	CRC-16 (high)	19
8	CRC-16 (low)	EC



- *1) When a broadcasting is performed, a response is not returned.
- *2) Note that the value of starting address is one less than the actual address.
- *3) Specify the number of bytes to be actually changed instead of the number of holding registers.



- When a writing to multiple coils cannot be executed normally, see "14.4.9 Exceptional Responses".

14.4.8 Read/Write Multiple Registers [17h]

- Write and read out to consecutive multiple registers.

(Example)

To the inverter with slave address "1", to write 50.00Hz for the output frequency setting [FA-01] and read out output frequency monitor value [dA-01].

Query:

No.	Field Name	Example (Hex)	
1	Slave address	01	
2	Function code	17	
3	Readout register starting address (high) *1)	27	} (Register address) = (register No.) - 1
4	Readout register starting address (low) *1)	10	
5	The number of readout registers (high)	00	
6	The number of readout registers (low)	01	
7	Writing register starting address (high) *1)	2A	} (Register address) = (register No.) - 1
8	Writing register starting address (low) *1)	F8	
9	The number of writing registers (high)	00	
10	The number of writing registers (low)	01	
11	Writing data bytes n	02	
12	Writing data 1 (high)	13	} 1388h → 5000d → 50.00Hz
13	Writing data 1 (low)	88	
14	CRC-16 (high)	77	
15	CRC-16 (low)	A3	

Response:

No.	Field Name	Example (Hex)	
1	Slave address	01	
2	Function code	17	
3	Readout data bytes n	02	
4	Readout data 1 (high)	13	} 1388h → 5000d → 50.00Hz
5	Readout data 1 (low)	88	
6	CRC-16 (high)	B0	
7	CRC-16 (low)	E2	



- *1) Note that the starting address of holding register is one less than the register No. The value obtained by subtracting one from the register No. is the register address.



- When a writing and reading out to multiple registers cannot be executed normally, see "14.4.9 Exceptional Responses".

14.4.9 Exceptional Responses

- The master sends a query and requests a response from the slave, except a broadcast query. Inverters have to return responses corresponding to queries, but when there is an error in queries, inverters return an exceptional response.
- Details of the field composition are shown below. The value of function code is obtained by adding 80h to a query subjected to an exceptional response. An exception code indicates a factor of exceptional response.

- Field composition for exceptional response is as shown below.

Field composition

Slave address
Function code
Exception code
CRC-16

Function code

Query	Exception Response
01h	81h
03h	83h
05h	85h
06h	86h
0Fh	8Fh
10h	90h
17h	97h

Exception code

Code	Description
01h	An unsupported function was specified.
02h	The specified address does not exist.
03h	The specified data is in an unacceptable format.
21h	In writing to a holding register, the data is beyond the range of the inverter.
22h	The inverter is in the state that it doesn't permit functions to be executed as following: <ul style="list-style-type: none"> • a register for which changes are inhibited during running was about to be changed; • data was written to a register to which soft-lock has been applied; • an ENTER instruction was executed during running; • an ENTER instruction was executed during undervoltage; • data was about to be written to a register when auto-tuning is enable; and so on.
23h	A function code for writing was used to the parameter specialized for readout.
26h	Data was written during data writing or execution of data initialization.
27h	There was an access to only the higher side register of 2 register long parameter.

14.4.10 Storing a Change Made to holding register

- When only the writing command to a holding register (06h) and the writing command to multiple registers (10h) are used, the changes data is written only to the RAM and not to the Non-volatile memory.
- If the power of the inverter is shut off without writing the data to the Non-volatile memory, the data before the change will be restored.

■ ENTER instruction issuing method

- The writing of entire memory is performed when 1 is written to a holding register (9000(DEC)) using the writing command to a holding register (06h).

Cautions:

- Do not turn OFF the power during data writing by an ENTER instruction. If the power is turned OFF, the data is not stored properly. Monitor the signal (coil No. 0049h) during data writing to determine whether the data is being written or not.
- Frequent use of ENTER instruction may shorten the life of the inverter because the inverter's memory element has the limit of the number of rewriting times. Use of ENTER instruction must be kept minimized, and especially periodic and/or successive issuance of this instruction must be completely avoided.

- To store in the inverter a change made to holding register, you need to issue ENTER instruction in the procedure shown below.
- To change control constants such as a motor constant, you need to use ENTER instruction and recalculate control processing internal variables.

■ Data writing mode

- The inverter enters the data writing mode when 1 is written to a holding register (9002 (DEC)) using the writing command to a holding register (06h).
- The data changed by the writing command to a holding register (06h) after the inverter enters the data writing mode will be written both in the RAM area for temporary saving and in the ROM area for storing in the event of power-off. Then simultaneously the data writing mode will be released.
- If the inverter receives commands other than the writing command to a holding register (06h) after entering the data writing mode, the data writing mode will be released.
- Frequent use of data writing mode may shorten the life of the inverter because the inverter's memory element has the limit of the number of rewriting times. Use of data writing mode must be kept minimized, and especially periodic and/or successive issuance of this mode must be completely avoided.

ENTER instruction

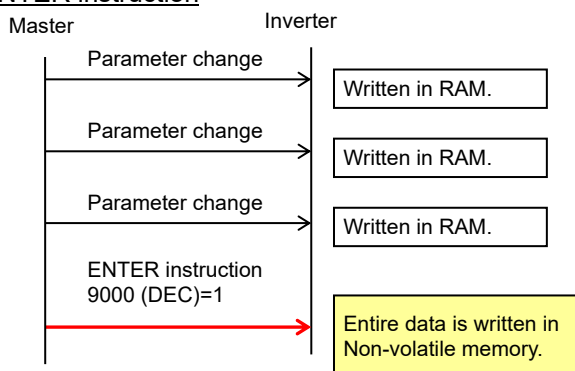

Data writing mode

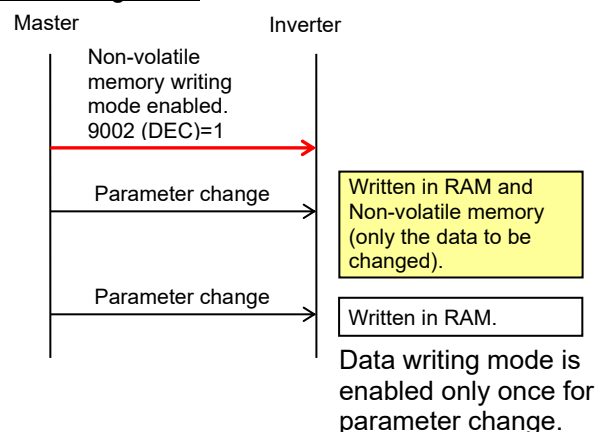

■ Recalculation of control processing internal variables

- Recalculation of control processing internal variables is performed when 1 is written to a holding register (9010 (DEC)) using the writing command to a holding register (06h).

14.5 EzCOM Function

14.5.1 What is EzCOM



- What is EzCOM?



- EzCOM is a function to allow multiple inverters to communicate each other without a master such as PC and PLC, aside from normal Modbus-RTU communication (slave).
- Rolls of inverters within the network of EzCOM are allocated to:
 - “Controlling inverter”
 - “Master inverter”
 - “Slave inverter”
- In the EzCOM network, the “controlling inverter” designates an inverter within the network as a “master inverter”, and the “master inverter” gives commands sequentially.
- As in the normal Modbus communication (RS-485), connect SP and SN terminals of respective inverters used in EzCOM communication.
- A master inverter is able to write 5 different commands to registers of arbitrary slave inverters.
- Once a data transmission between a master and slaves is completed, the controlling inverter shifts a master inverter sequentially and repeats a data transmission in accordance with the settings of respective master inverters.
- “Controlling inverter” is always fixed whereas “master inverter” is shifted sequentially. For this reason, the “controlling inverter” can be a “master inverter” or “slave inverter”.
- Up to 8 inverters can function as a “master inverter”.

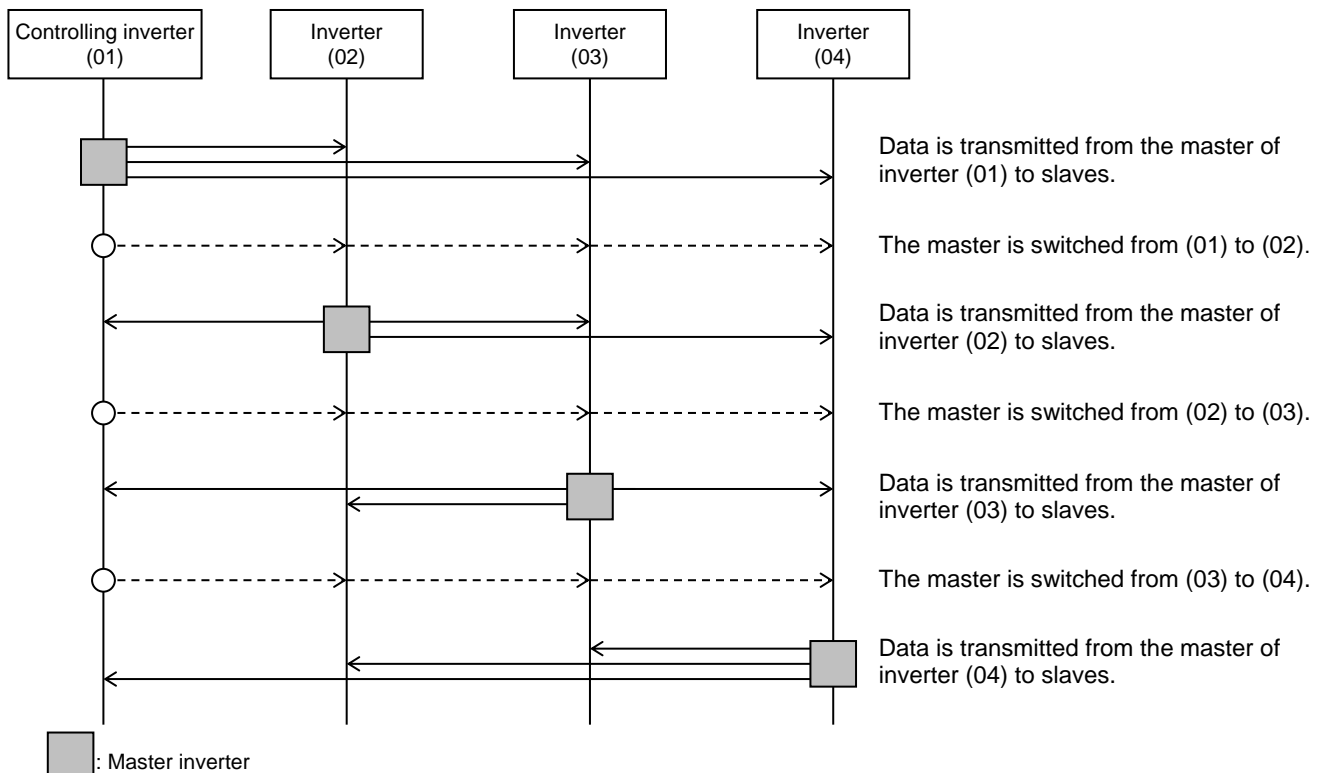

14.5.2 EzCOM Settings

- Set a station number for [CF-02] to each inverter of the EzCOM network, avoiding overlapping a station number. While doing so, make sure to assign a station number 1. The inverter with the station number 1 will be the “Controlling inverter”.
- Set the communication selection of controlling inverter to EzCOM communication’s “Controlling inverter” [CF-08]=03.
Set the communication selection of other inverters to EzCOM communication [CF-08]=02.
- Set the EzCOM communication start method [CF-22] to the controlling inverter. If you selected the input terminal start [CF-22]=00, assign 098 [ECOM] to any of input terminals 1 to 9, A or B.
- To a master inverter, set the number of transmitting data, the station number of transmission destination, register of transmission destination, and register of transmission source that are required for the master inverter to write the data (see the table of next page).

Item	Parameter	Data	Set-up Destination	Description
RS485 communication node address *1)	[CF-02]	1 to 247	ALL	Station number setting
RS485 communication error selection	[CF-05]	00	ALL	Error
		01	ALL	Error output after Deceleration stop
		02	ALL	Ignore
		03	ALL	Free run stop
		04	ALL	Deceleration stop
RS485 communication timeout setting	[CF-06]	0.00	ALL	Communication timeout disabled
		0.01 to 100.00	ALL	Unit [s]
RS485 communication wait time setting	[CF-07]	0 to 1000	ALL	Unit [ms]
RS485 communication mode selection	[CF-08]	01	—	Modbus-RTU communication
		02	B	EzCOM communication
		03	A	EzCOM communication < controlling inverter >
EzCOM start node No. *2)	[CF-20]	1 to 8	A	Setting required for controlling inverter only.
EzCOM end node No. *2)	[CF-21]	1 to 8	A	Setting required for controlling inverter only.
EzCOM start method selection	[CF-22]	00	A	Start-up by input terminal
		01	A	Always communication
Input terminal function	[CA-01] to [CA-11]	098	A	[ECOM]: Starting up of EzCOM

■ Set-up destinations.

ALL : Set to all inverters used for EzCOM.

A : Set to only an inverter for controlling (station number 01).

B : Set to inverters other than an inverter for controlling (station number 01).

*1) When you provide multiple master inverters, set consecutive station numbers (01, 02, 03, ...) to them. If the numbers are not consecutive, the inverters cannot perform communication.

*2) Note that the relationship between the master start/end station number settings must be [CF-20] ≤ [CF-21].

■ Command settings for assigning master inverters.

Item	Parameter	Data	Set-up Destination	Description
EzCOM data size	[CF-23]	1 to 5	M	Sets how many of the registers 1 to 5 shown below need to be transferred in EzCOM communication.
EzCOM destination address 1	[CF-24]	1 to 247	M	—
EzCOM destination register 1 *3)	[CF-25]	0000h to FFFFh	M	—
EzCOM source register 1 *3)	[CF-26]	0000h to FFFFh	M	—
EzCOM destination address 2	[CF-27]	1 to 247	M	—
EzCOM destination register 2 *3)	[CF-28]	0000h to FFFFh	M	—
EzCOM source register 2 *3)	[CF-29]	0000h to FFFFh	M	—
EzCOM destination address 3	[CF-30]	1 to 247	M	—
EzCOM destination register 3 *3)	[CF-31]	0000h to FFFFh	M	—
EzCOM source register 3 *3)	[CF-32]	0000h to FFFFh	M	—
EzCOM destination address 4	[CF-33]	1 to 247	M	—
EzCOM destination register 4 *3)	[CF-34]	0000h to FFFFh	M	—
EzCOM source register 4 *3)	[CF-35]	0000h to FFFFh	M	—
EzCOM destination address 5	[CF-36]	1 to 247	M	—
EzCOM destination register 5 *3)	[CF-37]	0000h to FFFFh	M	—
EzCOM source register 5 *3)	[CF-38]	0000h to FFFFh	M	—

■ Set-up destinations.

M: Perform the setting to inverters having station numbers designated in [CF-20] and [CF-21] (= master inverters).

*3) As for the transmission destination register and the transmission source register, specify the register address obtained by subtracting one from the register No.

14.5.3 EzCOM Operations



- (1) A master inverter transmits data to slave inverters according to the settings made to the master inverter.
- (2) The controlling inverter transmits a master switching command, and then a master inverter is switched.
- (3) The next master inverter transmits data to slave inverters as described in (1).
- (4) Processes of (2) and (3) will follow, and the whole processes will be repeated likewise.



- Entire communication data is transmitted to all stations because EzCOM communication is performed by broadcast communication. As a result, a slave not designated as transmission destinations on the master side receives data once, but internally discards the data which is not addressed to it.

14.5.4 Examples of EzCOM communication

- Shown below is communication sequences of inverters with station numbers 01 to 04 (four inverters in total), where the inverters 01 to 03 are designated as master inverters.

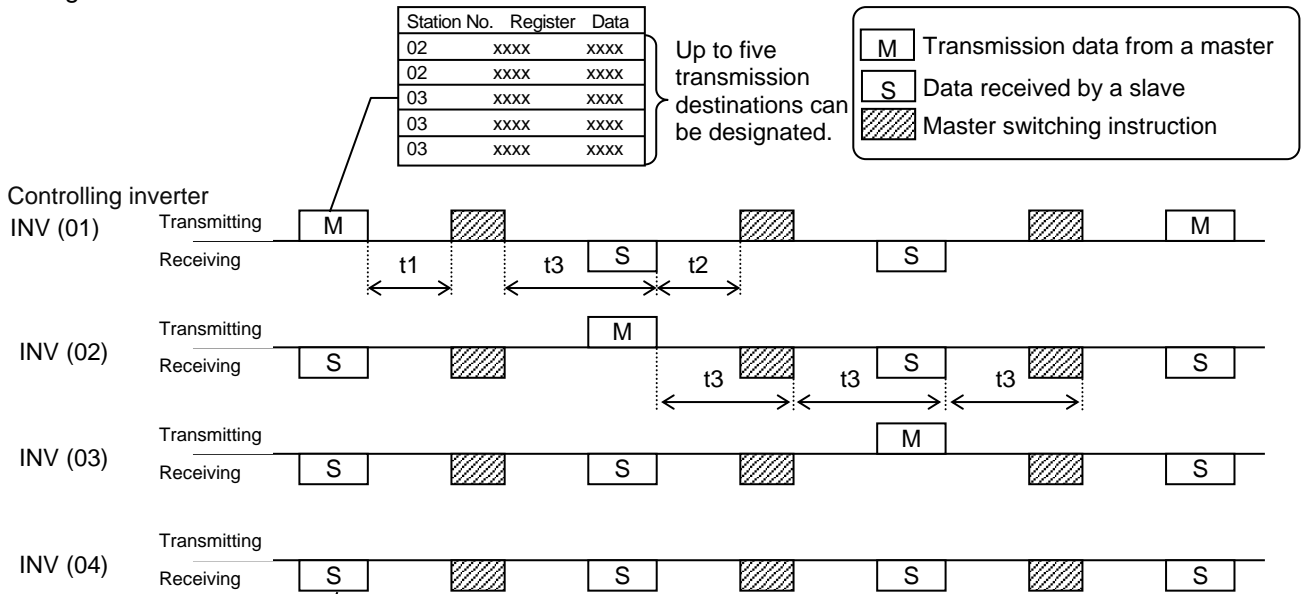

Although all slaves receive data from a master, if there is no data addressed to them, the received data by them will be discarded.

t1: Silent interval + communication waiting time [CF-07]
 t2: Silent interval + communication waiting time [CF-07]
 t3: Communication timeout time [CF-06]



- Communication timeout time [CF-06] for the controlling inverter, make sure to set value other than 0 (1 second or longer is recommended). Otherwise, the EzCOM function will stop when the communication is timed-out and data from a master inverter cannot be received. When the EzCOM function is stopped, reset the controlling inverter by turning on the power again or by resetting with the [RS] terminal.
- If the controlling inverter is a master inverter, a master switching instruction is transmitted after the master inverter transmits data followed by a silent interval + communication waiting time [CF-07] (aforementioned t1).
- If an inverter other than the controlling inverter is a master inverter, a master switching instruction is transmitted after the data from the master inverter is received followed by a silent interval + communication waiting time [CF-07] (aforementioned t2).
- The timer of communication timeout starts counting from the start of reception waiting. If data reception isn't completed within a set time, the communication will be timed-out (aforementioned t3), and the inverter behaves in accordance with the communication error selection [CF-05].



- When continuous communication [CF-22]=01 is selected in EzCOM start selection, the controlling inverter starts a transmission as soon as the power is turned ON. If the other inverters are turned ON late, a normal communication cannot be performed and the controlling inverter issues a communication timeout. Where always communication is selected, turn ON the controlling inverter after confirming that the other inverters have been turned ON.
- Do not set 08FFh (data writing) or 0901h (data writing mode selection) to transmission destination registers.
- When [CF-08], [CF-20] to [CF-22] are changed, the setting change is reflected by turn on the power supply again or reset with the [RS] input terminal.

14.6 Lists of Coils and Communication Registers

14.6.1 Precautions at setting registers and coils

- R or W shown in the lists indicates whether a coil or register can be used for readout or writing.
R: only readout
W: only writing
R/W: both readout and writing
- Parameter shown in outline characters in the “Coil No. (decimal)” or “Function code” columns of the lists are parameters added in the Ver. 2.00. Do not access to those parameters for Ver.1.xx.
- For details of setting and monitoring range, see Chapter 12, Chapter 13 and Appendix A1.3 List of Monitor Modes and A1.4 List of Parameter Modes.
In addition, note that there are some parameters for which monitor and/or setting range varies depending on versions.
- The setting ranges shown in the lists are values in the condition where the parameter [CF-11] register data selection (A, V↔% conversion function) is set to “00:(A, V)”.
Note that where the parameter selection is set to “01:(%)”, monitor and setting range for a current/voltage related parameter is shown in percentage to the rated value.
- Note that, as shown in the tables below, register numbers and data types were changed from Ver.1.xx.

① Frequency reference (after calculation)

Ver.1.xx				Ver.2.00			
Function Code	Register No. (decimal)	Register No. (hexadecimal)	Monitor content	Function Code	Register No. (decimal)	Register No. (hexadecimal)	Monitor content
dA-04	10004	2714h	0 to 59000 (w/o sign)	dA-04 (dA-05)	10004 (high) 10005 (low)	2714h (high) 2715h (low)	-59000 to 59000 (with sign)

② RS485 Set frequency

Ver.1.xx				Ver.2.00			
Function Code	Register No. (decimal)	Register No. (hexadecimal)	Monitor content	Function Code	Register No. (decimal)	Register No. (hexadecimal)	Monitor content
-	10502 (high)	2906h (high)	0 to 59000 (with sign)	Not changed			-59000 to 59000 (with sign)
-	10503 (low)	2907h (low)					

③ Sub-speed command (monitor + setting)

Ver.1.xx				Ver.2.00			
Function Code	Register No. (decimal)	Register No. (hexadecimal)	Monitor content	Function Code	Register No. (decimal)	Register No. (hexadecimal)	Monitor content
FA-02	11002	2AFAh	0 to 59000 (w/o sign)	FA-02 (FA-03)	11002 (high) 11003 (low)	2AFAh (high) 2AFBh (low)	-59000 to +59000 (monitor) 0 to 59000 (setting) (with sign)

14.6.2 List of coil numbers

Coil No. (decimal)	Coil No. (hexadecimal)	Item name	R/W	Setting description
0	0000h	(Reserved)		
1	0001h	RUN command	R/W	1: Run / 0: Stop (enabled when AA111/AA211=03)
2	0002h	Rotation direction command	R/W	1: Reverse / 0: Forward (enabled when AA111/AA211=03)
3	0003h	External trip [EXT]	R/W	1: [EXT] ON / 0: [EXT] OFF
4	0004h	Trip reset [RS]	R/W	1: [RS] ON / 0: [RS] OFF
5	0005h	Input terminal 1	R/W	1: ON/0: OFF
6	0006h	Input terminal 2	R/W	1: ON/0: OFF
7	0007h	Input terminal 3	R/W	1: ON/0: OFF
8	0008h	Input terminal 4	R/W	1: ON/0: OFF
9	0009h	Input terminal 5	R/W	1: ON/0: OFF
10	000Ah	Input terminal 6	R/W	1: ON/0: OFF
11	000Bh	Input terminal 7	R/W	1: ON/0: OFF
12	000Ch	Input terminal 8	R/W	1: ON/0: OFF
13	000Dh	Input terminal 9	R/W	1: ON/0: OFF
14	000Eh	Input terminal A	R/W	1: ON/0: OFF
15	000Fh	Input terminal B	R/W	1: ON/0: OFF
16	0010h	(Reserved)		
		(Reserved)		
20	0014h	(Reserved)		
21	0015h	Operating status	R	1:Forward or Reverse operation / 0:Other than Forward/Reverse operation (linked with dA-03)
22	0016h	Rotation direction	R	1:Reverse operation/0:Forward operation (linked with dA-03)
23	0017h	Inverter operation ready completion	R	1: Ready / 0: Not ready
24	0018h	(Reserved)		
25	0019h	Output terminal 11	R	1: ON/0: OFF
26	001Ah	Output terminal 12	R	1: ON/0: OFF
27	001Bh	Output terminal 13	R	1: ON/0: OFF
28	001Ch	Output terminal 14	R	1: ON/0: OFF
29	001Dh	Output terminal 15	R	1: ON/0: OFF
30	001Eh	Output terminal 16	R	1: ON/0: OFF
31	001Fh	Output terminal AL	R	1: ON/0: OFF
32	0020h	(Reserved)		
72	0048h	(Reserved)		
73	0049h	Data being written	R	1: Being written / 0: Normal state
74	004Ah	CRC error	R	1: With error / 0: No error
75	004Bh	Overrun error	R	1: With error / 0: No error
76	004Ch	Framing error	R	1: With error / 0: No error
77	004Dh	Parity error	R	1: With error / 0: No error
78	004Eh	Sum check error	R	1: With error / 0: No error
79 to	004Fh to	(Reserved)		

14.6.3 List of register numbers

(Monitor (Code-d))

Function Code	Register No. (decimal)	Register No. (hexadecimal)	Function Name	R/W	Monitor Content and Setting Item	Data Resolution / Unit
dA-01	10001	2711h	Output frequency monitor	R	0 to 59000	0.01Hz
dA-02	10002	2712h	Output current monitor	R	0 to 65535 (132kW or Lower) 0 to 65535 (160kW or Upper)	0.01A 0.1A
dA-03	10003	2713h	Rotation direction monitor	R	0 to 3	1
dA-04	10004	2714h	Frequency reference monitor (after calculation) (High)	R	-59000 to 59000 (Register No. and monitor range are not the same with Ver1.xx.)	0.01Hz
(dA-05)	10005	2715h	(Low)			
dA-06	10006	2716h	Output frequency scale conversion monitor (High)	R	0 to 5900000	0.01
(dA-07)	10007	2717h	(Low)			
dA-08	10008	2718h	Detect speed monitor (High)	R	-59000 to 59000	0.01Hz
(dA-09)	10009	2719h	(Low)			
dA-12	10012	271Ch	Output frequency monitor (signed) (High)	R	-59000 to 59000	0.01Hz
(dA-13)	10013	271Dh	(Low)			
dA-14	10014	271Eh	Frequency upper limit monitor	R	0 to 59000	0.01Hz
dA-15	10015	271Fh	Torque reference monitor (after calculation)	R	-10000 to 10000	0.1%
dA-16	10016	2720h	Torque limit monitor	R	0 to 5000	0.1%
dA-17	10017	2721h	Output torque monitor	R	-10000 to 10000	0.1%
dA-18	10018	2722h	Output voltage monitor (RMS)	R	0 to 8000	0.1V
dA-20	10020	2724h	Current position monitor (High)	R	-536870912 to 536870911 In high resolution mode: -2147483648 to 2147483647	1pls
(dA-21)	10021	2725h	(Low)			
dA-26	10026	272Ah	Pulse train position deviation monitor (High)	R	-2147483647 to 2147483647	1pls
(dA-27)	10027	272Bh	(Low)			
dA-28	10028	272Ch	Pulse counter monitor (High)	R	0 to 2147483647	1pls
(dA-29)	10029	272Dh	(Low)			
dA-30	10030	272Eh	Input power monitor	R	0 to 65535 (132kW or Lower) 0 to 65535 (160kW or Upper)	0.01kW 0.1kW
dA-32	10032	2730h	Accumulated input power monitor (High)	R	0 to 10000000	0.1kWh
(dA-33)	10033	2731h	(Low)			
dA-34	10034	2732h	Output power monitor	R	0 to 65535 (132kW or Lower) 0 to 65535 (160kW or Upper)	0.01kW 0.1kW
dA-36	10036	2734h	Accumulated output power monitor (High)	R	0 to 10000000	0.1kWh
(dA-37)	10037	2735h	(Low)			
dA-38	10038	2736h	Motor temperature monitor	R	-200 to 2000	0.1°C
dA-40	10040	2738h	DC bus voltage monitor	R	0 to 10000	0.1VDC
dA-41	10041	2739h	BRD load rate monitor	R	0 to 10000	0.01%
dA-42	10042	273Ah	Electronic thermal load rating monitor (Motor)	R	0 to 10000	0.01%
dA-43	10043	273Bh	Electronic thermal load rating monitor (Inverter)	R	0 to 10000	0.01%
dA-45	10045	273Dh	Safety STO monitor	R	0 to 7	1
dA-46	10046	273Eh	Safety option hardware monitor	R	0 to 0xFFFF	1
dA-47	10047	273Fh	Safety option function monitor	R	0 to 6	1
dA-50	10050	2742h	Control terminal type	R	0 to 15	1
dA-51	10051	2743h	Input terminal monitor	R	0 to 0xFFFF	1
dA-54	10054	2746h	Output terminal monitor	R	0 to 0xFF	1

Function Code	Register No. (decimal)	Register No. (hexadecimal)	Function Name	R/W	Monitor Content and Setting Item	Data Resolution / Unit
dA-60	10060	274Ch	Analog input/output status monitor	R	0 to 0xFF	1
dA-61	10061	274Dh	Analog input [Ai1] monitor	R	0 to 10000	0.01%
dA-62	10062	274Eh	Analog input [Ai2] monitor	R	0 to 10000	0.01%
dA-63	10063	274Fh	Analog input [Ai3] monitor	R	-10000 to 10000	0.01%
dA-64	10064	2750h	Analog input [Ai4] monitor	R	0 to 10000	0.01%
dA-65	10065	2751h	Analog input [Ai5] monitor	R	0 to 10000	0.01%
dA-66	10066	2752h	Analog input [Ai6] monitor	R	-10000 to 10000	0.01%
dA-70	10070	2756h	Pulse train input monitor (Internal)	R	-10000 to 10000	0.01%
dA-71	10071	2757h	Pulse train input monitor (option)	R	-10000 to 10000	0.01%
dA-81	10081	2761h	Option slot-1 status	R	0 to 48	1
dA-82	10082	2762h	Option slot-2 status	R	0 to 48	1
dA-83	10083	2763h	Option slot-3 status	R	0 to 48	1
db-01	10101	2775h	Program download monitor	R	0 to 1	1
db-02	10102	2776h	Program No. monitor	R	0 to 9999	1
db-03	10103	2777h	Program counter (Task-1)	R	1 to 1024	1
db-04	10104	2778h	Program counter (Task-2)	R	1 to 1024	1
db-05	10105	2779h	Program counter (Task-3)	R	1 to 1024	1
db-06	10106	277Ah	Program counter (Task-4)	R	1 to 1024	1
db-07	10107	277Bh	Program counter (Task-5)	R	1 to 1024	1
db-08	10108	277Ch	User monitor 0	R	-2147483647 to 2147483647	1
(db-09)	10109	277Dh	(High) (Low)			
db-10	10110	277Eh	User monitor 1	R	-2147483647 to 2147483647	1
(db-11)	10111	277Fh	(High) (Low)			
db-12	10112	2780h	User monitor 2	R	-2147483647 to 2147483647	1
(db-13)	10113	2781h	(High) (Low)			
db-14	10114	2782h	User monitor 3	R	-2147483647 to 2147483647	1
(db-15)	10115	2783h	(High) (Low)			
db-16	10116	2784h	User monitor 4	R	-2147483647 to 2147483647	1
(db-17)	10117	2785h	(High) (Low)			
db-18	10118	2786h	Analog output monitor YA0	R	0 to 10000	0.01%
db-19	10119	2787h	Analog output monitor YA1	R	0 to 10000	0.01%
db-20	10120	2788h	Analog output monitor YA2	R	0 to 10000	0.01%
db-21	10121	2789h	Analog output monitor YA3	R	0 to 10000	0.01%
db-22	10122	278Ah	Analog output monitor YA4	R	0 to 10000	0.01%
db-23	10123	278Bh	Analog output monitor YA5	R	0 to 10000	0.01%
db-30	10130	2792h	PID1 feedback value1 monitor	R	-10000 to 10000	Per AH-06 setting
(db-31)	10131	2793h	(High) (Low)			
db-32	10132	2794h	PID1 feedback value2 monitor	R	-10000 to 10000	Per AH-06 setting
(db-33)	10133	2795h	(High) (Low)			
db-34	10134	2796h	PID1 feedback value3 monitor	R	-10000 to 10000	Per AH-06 setting
(db-35)	10135	2797h	(High) (Low)			
db-36	10136	2798h	PID2 feedback value monitor	R	-10000 to 10000	Per AJ-06 setting
(db-37)	10137	2799h	(High) (Low)			
db-38	10138	279Ah	PID3 feedback value monitor	R	-10000 to 10000	Per AJ-26 setting
(db-39)	10139	279Bh	(High) (Low)			
db-40	10140	279Ch	PID4 feedback value monitor	R	-10000 to 10000	Per AJ-46 setting
(db-41)	10141	279Dh	(High) (Low)			

Function Code	Register No. (decimal)	Register No. (hexadecimal)	Function Name	R/W	Monitor Content and Setting Item	Data Resolution / Unit
db-42	10142	279Eh	PID1 target value monitor (after calculation) (High)	R	-10000 to 10000	Per AH-06 setting
(db-43)	10143	279Fh	(Low)			
db-44	10144	27A0h	PID1 feedback value monitor (after calculation) (High)	R	-10000 to 10000	Per AH-06 setting
(db-45)	10145	27A1h	(Low)			
db-50	10150	27A6h	PID1 output monitor	R	-10000 to 10000	0.01%
db-51	10151	27A7h	PID1 deviation monitor	R	-20000 to 20000	0.01%
db-52	10152	27A8h	PID1 deviation 1 monitor	R	-20000 to 20000	0.01%
db-53	10153	27A9h	PID1 deviation 2 monitor	R	-20000 to 20000	0.01%
db-54	10154	27AAh	PID1 deviation 3 monitor	R	-20000 to 20000	0.01%
db-55	10155	27ABh	PID2 output monitor	R	-10000 to 10000	0.01%
db-56	10156	27ACh	PID2 deviation monitor	R	-20000 to 20000	0.01%
db-57	10157	27ADh	PID3 output monitor	R	-10000 to 10000	0.01%
db-58	10158	27AEh	PID3 deviation monitor	R	-20000 to 20000	0.01%
db-59	10159	27AFh	PID4 output monitor	R	-10000 to 10000	0.01%
db-60	10160	27B0h	PID4 deviation monitor	R	-20000 to 20000	0.01%
db-61	10161	27B1h	Current PID P-Gain monitor	R	0 to 1000	0.1 x
db-62	10162	27B2h	Current PID I-Gain monitor	R	0 to 36000	0.1s
db-63	10163	27B3h	Current PID D-Gain monitor	R	0 to 10000	0.01s
db-64	10164	27B4h	PID feed forward monitor	R	0 to 10000	0.01%
dC-01	10201	27D9h	Inverter load type status	R	0 to 2	1
dC-02	10202	27DAh	Rated current monitor	R	0 to 65535	0.1A
dC-07	10207	27DFh	Main speed input source monitor	R	0 to 34	1
dC-08	10208	27E0h	Sub speed input source monitor	R	0 to 34	1
dC-10	10210	27E2h	RUN command input source monitor	R	0 to 6	1
dC-15	10215	27E7h	Cooling fin temperature monitor	R	-200 to 2000	0.1°C
dC-16	10216	27E8h	Life assessment monitor	R	0 to 0xFF	1
dC-20	10220	27ECh	Accumulated number of starts monitor	R	1 to 65535	1
dC-21	10221	27EDh	Accumulated number of power-on times monitor	R	1 to 65535	1
dC-22	10222	27EEh	Accumulated RUN time monitor (High)	R	0 to 1000000	1hr
(dC-23)	10223	27EFh	(Low)			
dC-24	10224	27F0h	Accumulated power-on time monitor (High)	R	0 to 1000000	1hr
(dC-25)	10225	27F1h	(Low)			
dC-26	10226	27F2h	Accumulated cooling-fan run time monitor (High)	R	0 to 1000000	1hr
(dC-27)	10227	27F3h	(Low)			
dC-37	10237	27FDh	Icon 2 LIM monitor	R	0 to 6	1
dC-38	10238	27FEh	Icon 2 ALT monitor	R	0 to 4	1
dC-39	10239	27FFh	Icon 2 RETRY detail monitor	R	0 to 2	1
dC-40	10240	2800h	Icon 2 NRDY detail monitor	R	0 to 9	1
dC-45	10245	2805h	IM/SM monitor	R	0 to 1	1
dC-50	10250	280Ah	Firmware Ver. monitor	R	0 to 0xFFFF Higher 1 byte: Major Lower 1 byte: Minor 1	1
dC-53	10253	280Dh	Firmware Gr. monitor	R	0 to 1	1

(Trip monitor)

Function Code	Register No. (decimal)	Register No. (hexadecimal)	Function Name	R/W	Monitor Content and Setting Item	Data Resolution / Unit
Trip monitor (dE-01)	1000	03E8h	Trip count monitor	R	0 to 65535	1
Trip monitor (dE-11)	1001	03E9h	Trip monitor 1 Factor	R	1 to 255	1
	1002	03EAh	Trip monitor 1 Output frequency (High)	R	-59000 to 59000	0.01Hz
	1003	03EBh	(with sign) (Low)			
	1004	03ECh	Trip monitor 1 Output current	R	0 to 65535	0.01A
	1005	03EDh	Trip monitor 1 P-N DC voltage	R	0 to 10000	0.1VDC
	1006	03EEh	Trip monitor 1 Inverter state	R	0 to 8	1
	1007	03EFh	Trip monitor 1 LAD state	R	0 to 5	1
	1008	03F0h	Trip monitor 1 INV control mode	R	0 to 11	1
	1009	03F1h	Trip monitor 1 Limit state	R	0 to 6	1
	1010	03F2h	Trip monitor 1 Special state	R	0 to 6	1
	1012	03F4h	Trip monitor 1 RUN time (High)	R	0 to 1000000	1hr
	1013	03F5h	(Low)			
	1014	03F6h	Trip monitor 1 Power ON time (High)	R	0 to 1000000	1hr
	1015	03F7h	(Low)			
	1016	03F8h	Trip monitor 1 Absolute time (year, month)	R	00 - 99 (BCD code) 01 - 12 (BCD code)	1 1
1017	03F9h	Trip monitor 1 Absolute time (day, day of the week)	R	01 - 31 (BCD code) 00 - 06 (BCD code)	1 1	
1018	03FAh	Trip monitor 1 Absolute time (hour, minute)	R	00 - 23 (BCD code) 00 - 59 (BCD code)	1 1	
Trip monitor (dE-12)	1021	03FDh	Trip monitor 2 Factor	R	1 to 255	1
	1022	03FEh	Trip monitor 2 Output frequency (High)	R	-59000 to 59000	0.01Hz
	1023	03FFh	(with sign) (Low)			
	1024	0400h	Trip monitor 2 Output current	R	0 to 65535	0.01A
	1025	0401h	Trip monitor 2 P-N DC voltage	R	0 to 10000	0.1VDC
	1026	0402h	Trip monitor 2 Inverter state	R	0 to 8	1
	1027	0403h	Trip monitor 2 LAD state	R	0 to 5	1
	1028	0404h	Trip monitor 2 INV control mode	R	0 to 11	1
	1029	0405h	Trip monitor 2 Limit state	R	0 to 6	1
	1030	0406h	Trip monitor 2 Special state	R	0 to 6	1
	1032	0408h	Trip monitor 2 RUN time (High)	R	0 to 1000000	1hr
	1033	0409h	(Low)			
	1034	040Ah	Trip monitor 2 Power ON time (High)	R	0 to 1000000	1hr
	1035	040Bh	(Low)			
	1036	040Ch	Trip monitor 2 Absolute time (year, month)	R	00 - 99 (BCD code) 01 - 12 (BCD code)	1 1
1037	040Dh	Trip monitor 2 Absolute time (day, day of the week)	R	01 - 31 (BCD code) 00 - 06 (BCD code)	1 1	
1038	040Eh	Trip monitor 2 Absolute time (hour, minute)	R	00 - 23 (BCD code) 00 - 59 (BCD code)	1 1	

Function Code	Register No. (decimal)	Register No. (hexadecimal)	Function Name	R/W	Monitor Content and Setting Item	Data Resolution / Unit
Trip monitor (dE-13)	1041	0411h	Trip monitor 3 Factor	R	1 to 255	1
	1042	0412h	Trip monitor 3 Output frequency (High)	R	-59000 to 59000	0.01Hz
	1043	0413h	(with sign) (Low)			
	1044	0414h	Trip monitor 3 Output current	R	0 to 65535	0.01A
	1045	0415h	Trip monitor 3 P-N DC voltage	R	0 to 10000	0.1VDC
	1046	0416h	Trip monitor 3 Inverter state	R	0 to 8	1
	1047	0417h	Trip monitor 3 LAD state	R	0 to 5	1
	1048	0418h	Trip monitor 3 INV control mode	R	0 to 11	1
	1049	0419h	Trip monitor 3 Limit state	R	0 to 6	1
	1050	041Ah	Trip monitor 3 Special state	R	0 to 6	1
	1052	041Ch	Trip monitor 3 RUN time (High)	R	0 to 1000000	1hr
	1053	041Dh	(Low)			
	1054	041Eh	Trip monitor 3 Power ON time (High)	R	0 to 1000000	1hr
	1055	041Fh	(Low)			
	1056	0420h	Trip monitor 3 Absolute time (year, month)	R	00 - 99 (BCD code) 01 - 12 (BCD code)	1 1
1057	0421h	Trip monitor 3 Absolute time (day, day of the week)	R	01 - 31 (BCD code) 00 - 06 (BCD code)	1 1	
1058	0422h	Trip monitor 3 Absolute time (hour, minute)	R	00 - 23 (BCD code) 00 - 59 (BCD code)	1 1	
Trip monitor (dE-14)	1061	0425h	Trip monitor 4 Factor	R	1 to 255	1
	1062	0426h	Trip monitor 4 Output frequency (High)	R	-59000 to 59000	0.01Hz
	1063	0427h	(with sign) (Low)			
	1064	0428h	Trip monitor 4 Output current	R	0 to 65535	0.01A
	1065	0429h	Trip monitor 4 P-N DC voltage	R	0 to 10000	0.1VDC
	1066	042Ah	Trip monitor 4 Inverter state	R	0 to 8	1
	1067	042Bh	Trip monitor 4 LAD state	R	0 to 5	1
	1068	042Ch	Trip monitor 4 INV control mode	R	0 to 11	1
	1069	042Dh	Trip monitor 4 Limit state	R	0 to 6	1
	1070	042Eh	Trip monitor 4 Special state	R	0 to 6	1
	1072	0430h	Trip monitor 4 RUN time (High)	R	0 to 1000000	1hr
	1073	0431h	(Low)			
	1074	0432h	Trip monitor 4 Power ON time (High)	R	0 to 1000000	1hr
	1075	0433h	(Low)			
	1076	0434h	Trip monitor 4 Absolute time (year, month)	R	00 - 99 (BCD code) 01 - 12 (BCD code)	1 1
1077	0435h	Trip monitor 4 Absolute time (day, day of the week)	R	01 - 31 (BCD code) 00 - 06 (BCD code)	1 1	
1078	0436h	Trip monitor 4 Absolute time (hour, minute)	R	00 - 23 (BCD code) 00 - 59 (BCD code)	1 1	

Function Code	Register No. (decimal)	Register No. (hexadecimal)	Function Name	R/W	Monitor Content and Setting Item	Data Resolution / Unit
Trip monitor (dE-15)	1081	0439h	Trip monitor 5 Factor	R	1 to 255	1
	1082	043Ah	Trip monitor 5 Output frequency (High)	R	-59000 to 59000	0.01Hz
	1083	043Bh	(with sign) (Low)			
	1084	043Ch	Trip monitor 5 Output current	R	0 to 65535	0.01A
	1085	043Dh	Trip monitor 5 P-N DC voltage	R	0 to 10000	0.1VDC
	1086	043Eh	Trip monitor 5 Inverter state	R	0 to 8	1
	1087	043Fh	Trip monitor 5 LAD state	R	0 to 5	1
	1088	0440h	Trip monitor 5 INV control mode	R	0 to 11	1
	1089	0441h	Trip monitor 5 Limit state	R	0 to 6	1
	1090	0442h	Trip monitor 5 Special state	R	0 to 6	1
	1092	0444h	Trip monitor 5 RUN time (High)	R	0 to 1000000	1hr
	1093	0445h	(Low)			
	1094	0446h	Trip monitor 5 Power ON time (High)	R	0 to 1000000	1hr
	1095	0447h	(Low)			
	1096	0448h	Trip monitor 5 Absolute time (year, month)	R	00 - 99 (BCD code) 01 - 12 (BCD code)	1 1
1097	0449h	Trip monitor 5 Absolute time (day, day of the week)	R	01 - 31 (BCD code) 00 - 06 (BCD code)	1 1	
1098	044Ah	Trip monitor 5 Absolute time (hour, minute)	R	00 - 23 (BCD code) 00 - 59 (BCD code)	1 1	
Trip monitor (dE-16)	1101	044Dh	Trip monitor 6 Factor	R	1 to 255	1
	1102	044Eh	Trip monitor 6 Output frequency (High)	R	-59000 to 59000	0.01Hz
	1103	044Fh	(with sign) (Low)			
	1104	0450h	Trip monitor 6 Output current	R	0 to 65535	0.01A
	1105	0451h	Trip monitor 6 P-N DC voltage	R	0 to 10000	0.1VDC
	1106	0452h	Trip monitor 6 Inverter state	R	0 to 8	1
	1107	0453h	Trip monitor 6 LAD state	R	0 to 5	1
	1108	0454h	Trip monitor 6 INV control mode	R	0 to 11	1
	1109	0455h	Trip monitor 6 Limit state	R	0 to 6	1
	1110	0456h	Trip monitor 6 Special state	R	0 to 6	1
	1112	0458h	Trip monitor 6 RUN time (High)	R	0 to 1000000	1hr
	1113	0459h	(Low)			
	1114	045Ah	Trip monitor 6 Power ON time (High)	R	0 to 1000000	1hr
	1115	045Bh	(Low)			
	1116	045Ch	Trip monitor 6 Absolute time (year, month)	R	00 - 99 (BCD code) 01 - 12 (BCD code)	1 1
1117	045Dh	Trip monitor 6 Absolute time (day, day of the week)	R	01 - 31 (BCD code) 00 - 06 (BCD code)	1 1	
1118	045Eh	Trip monitor 6 Absolute time (hour, minute)	R	00 - 23 (BCD code) 00 - 59 (BCD code)	1 1	

Function Code	Register No. (decimal)	Register No. (hexadecimal)	Function Name	R/W	Monitor Content and Setting Item	Data Resolution / Unit
Trip monitor (dE-17)	1121	0461h	Trip monitor 7 Factor	R	1 to 255	1
	1122	0462h	Trip monitor 7 Output frequency (High)	R	-59000 to 59000	0.01Hz
	1123	0463h	(with sign) (Low)			
	1124	0464h	Trip monitor 7 Output current	R	0 to 65535	0.01A
	1125	0465h	Trip monitor 7 P-N DC voltage	R	0 to 10000	0.1VDC
	1126	0466h	Trip monitor 7 Inverter state	R	0 to 8	1
	1127	0467h	Trip monitor 7 LAD state	R	0 to 5	1
	1128	0468h	Trip monitor 7 INV control mode	R	0 to 11	1
	1129	0469h	Trip monitor 7 Limit state	R	0 to 6	1
	1130	046Ah	Trip monitor 7 Special state	R	0 to 6	1
	1132	046Ch	Trip monitor 7 RUN time (High)	R	0 to 1000000	1hr
	1133	046Dh	(Low)			
	1134	046Eh	Trip monitor 7 Power ON time (High)	R	0 to 1000000	1hr
	1135	046Fh	(Low)			
	1136	0470h	Trip monitor 7 Absolute time (year, month)	R	00 - 99 (BCD code) 01 - 12 (BCD code)	1 1
1137	0471h	Trip monitor 7 Absolute time (day, day of the week)	R	01 - 31 (BCD code) 00 - 06 (BCD code)	1 1	
1138	0472h	Trip monitor 7 Absolute time (hour, minute)	R	00 - 23 (BCD code) 00 - 59 (BCD code)	1 1	
Trip monitor (dE-18)	1141	0475h	Trip monitor 8 Factor	R	1 to 255	1
	1142	0476h	Trip monitor 8 Output frequency (High)	R	-59000 to 59000	0.01Hz
	1143	0477h	(with sign) (Low)			
	1144	0478h	Trip monitor 8 Output current	R	0 to 65535	0.01A
	1145	0479h	Trip monitor 8 P-N DC voltage	R	0 to 10000	0.1VDC
	1146	047Ah	Trip monitor 8 Inverter state	R	0 to 8	1
	1147	047Bh	Trip monitor 8 LAD state	R	0 to 5	1
	1148	047Ch	Trip monitor 8 INV control mode	R	0 to 11	1
	1149	047Dh	Trip monitor 8 Limit state	R	0 to 6	1
	1150	047Eh	Trip monitor 8 Special state	R	0 to 6	1
	1152	0480h	Trip monitor 8 RUN time (High)	R	0 to 1000000	1hr
	1153	0481h	(Low)			
	1154	0482h	Trip monitor 8 Power ON time (High)	R	0 to 1000000	1hr
	1155	0483h	(Low)			
	1156	0484h	Trip monitor 8 Absolute time (year, month)	R	00 - 99 (BCD code) 01 - 12 (BCD code)	1 1
1157	0485h	Trip monitor 8 Absolute time (day, day of the week)	R	01 - 31 (BCD code) 00 - 06 (BCD code)	1 1	
1158	0486h	Trip monitor 8 Absolute time (hour, minute)	R	00 - 23 (BCD code) 00 - 59 (BCD code)	1 1	

Function Code	Register No. (decimal)	Register No. (hexadecimal)	Function Name	R/W	Monitor Content and Setting Item	Data Resolution / Unit
Trip monitor (dE-19)	1161	0489h	Trip monitor 9 Factor	R	1 to 255	1
	1162	048Ah	Trip monitor 9 Output frequency (High)	R	-59000 to 59000	0.01Hz
	1163	048Bh	(with sign) (Low)			
	1164	048Ch	Trip monitor 9 Output current	R	0 to 65535	0.01A
	1165	048Dh	Trip monitor 9 P-N DC voltage	R	0 to 10000	0.1VDC
	1166	048Eh	Trip monitor 9 Inverter state	R	0 to 8	1
	1167	048Fh	Trip monitor 9 LAD state	R	0 to 5	1
	1168	0490h	Trip monitor 9 INV control mode	R	0 to 11	1
	1169	0491h	Trip monitor 9 Limit state	R	0 to 6	1
	1170	0492h	Trip monitor 9 Special state	R	0 to 6	1
	1172	0494h	Trip monitor 9 RUN time (High)	R	0 to 1000000	1hr
	1173	0495h	(Low)			
	1174	0496h	Trip monitor 9 Power ON time (High)	R	0 to 1000000	1hr
	1175	0497h	(Low)			
	1176	0498h	Trip monitor 9 Absolute time (year, month)	R	00 - 99 (BCD code) 01 - 12 (BCD code)	1 1
1177	0499h	Trip monitor 9 Absolute time (day, day of the week)	R	01 - 31 (BCD code) 00 - 06 (BCD code)	1 1	
1178	049Ah	Trip monitor 9 Absolute time (hour, minute)	R	00 - 23 (BCD code) 00 - 59 (BCD code)	1 1	
Trip monitor (dE-20)	1181	049Dh	Trip monitor 10 Factor	R	1 to 255	1
	1182	049Eh	Trip monitor 10 Output frequency (High)	R	-59000 to 59000	0.01Hz
	1183	049Fh	(with sign) (Low)			
	1184	04A0h	Trip monitor 10 Output current	R	0 to 65535	0.01A
	1185	04A1h	Trip monitor 10 P-N DC voltage	R	0 to 10000	0.1VDC
	1186	04A2h	Trip monitor 10 Inverter state	R	0 to 8	1
	1187	04A3h	Trip monitor 10 LAD state	R	0 to 5	1
	1188	04A4h	Trip monitor 10 INV control mode	R	0 to 11	1
	1189	04A5h	Trip monitor 10 Limit state	R	0 to 6	1
	1190	04A6h	Trip monitor 10 Special state	R	0 to 6	1
	1192	04A8h	Trip monitor 10 RUN time (High)	R	0 to 1000000	1hr
	1193	04A9h	(Low)			
	1194	04AAh	Trip monitor 10 Power ON time (High)	R	0 to 1000000	1hr
	1195	04ABh	(Low)			
	1196	04ACh	Trip monitor 10 Absolute time (year, month)	R	00 - 99 (BCD code) 01 - 12 (BCD code)	1 1
1197	04ADh	Trip monitor 10 Absolute time (day, day of the week)	R	01 - 31 (BCD code) 00 - 06 (BCD code)	1 1	
1198	04AEh	Trip monitor 10 Absolute time (hour, minute)	R	00 - 23 (BCD code) 00 - 59 (BCD code)	1 1	

(Retry monitor)

Function Code	Register No. (decimal)	Register No. (hexadecimal)	Function Name	R/W	Monitor Content and Setting Item	Data Resolution / Unit
Retry monitor (dE-31)	1201	04B1h	Retry monitor 1 Factor	R	1 to 255	1
	1202	04B2h	Retry monitor 1 Output frequency (High)	R	-59000 to 59000	0.01Hz
	1203	04B3h	(with sign) (Low)			
	1204	04B4h	Retry monitor 1 Output current	R	0 to 65535	0.01A
	1205	04B5h	Retry monitor 1 P-N DC voltage	R	0 to 10000	0.1VDC
	1206	04B6h	Retry monitor 1 Inverter state	R	0 to 8	1
	1207	04B7h	Retry monitor 1 LAD state	R	0 to 5	1
	1208	04B8h	Retry monitor 1 INV control mode	R	0 to 11	1
	1209	04B9h	Retry monitor 1 Limit state	R	0 to 6	1
	1210	04BAh	Retry monitor 1 Special state	R	0 to 6	1
	1212	04BCh	Retry monitor 1 RUN time (High)	R	0 to 1000000	1hr
	1213	04BDh	(Low)			
	1214	04BEh	Retry monitor 1 Power ON time (High)	R	0 to 1000000	1hr
	1215	04BFh	(Low)			
	1216	04C0h	Retry monitor 1 Absolute time (year, month)	R	00 - 99 (BCD code) 01 - 12 (BCD code)	1 1
1217	04C1h	Retry monitor 1 Absolute time (day, day of the week)	R	01 - 31 (BCD code) 00 - 06 (BCD code)	1 1	
1218	04C2h	Retry monitor 1 Absolute time (hour, minute)	R	00 - 23 (BCD code) 00 - 59 (BCD code)	1 1	
Retry monitor (dE-32)	1221	04C5h	Retry monitor 2 Factor	R	1 to 255	1
	1222	04C6h	Retry monitor 2 Output frequency (High)	R	-59000 to 59000	0.01Hz
	1223	04C7h	(with sign) (Low)			
	1224	04C8h	Retry monitor 2 Output current	R	0 to 65535	0.01A
	1225	04C9h	Retry monitor 2 P-N DC voltage	R	0 to 10000	0.1VDC
	1226	04CAh	Retry monitor 2 Inverter state	R	0 to 8	1
	1227	04CBh	Retry monitor 2 LAD state	R	0 to 5	1
	1228	04CCh	Retry monitor 2 INV control mode	R	0 to 11	1
	1229	04CDh	Retry monitor 2 Limit state	R	0 to 6	1
	1230	04CEh	Retry monitor 2 Special state	R	0 to 6	1
	1232	04D0h	Retry monitor 2 RUN time (High)	R	0 to 1000000	1hr
	1233	04D1h	(Low)			
	1234	04D2h	Retry monitor 2 Power ON time (High)	R	0 to 1000000	1hr
	1235	04D3h	(Low)			
	1236	04D4h	Retry monitor 2 Absolute time (year, month)	R	00 - 99 (BCD code) 01 - 12 (BCD code)	1 1
1237	04D5h	Retry monitor 2 Absolute time (day, day of the week)	R	01 - 31 (BCD code) 00 - 06 (BCD code)	1 1	
1238	04D6h	Retry monitor 2 Absolute time (hour, minute)	R	00 - 23 (BCD code) 00 - 59 (BCD code)	1 1	

Function Code	Register No. (decimal)	Register No. (hexadecimal)	Function Name	R/W	Monitor Content and Setting Item	Data Resolution / Unit
Retry monitor (dE-33)	1241	04D9h	Retry monitor 3 Factor	R	1 to 255	1
	1242	04DAh	Retry monitor 3 Output frequency (High)	R	-59000 to 59000	0.01Hz
	1243	04DBh	(with sign) (Low)			
	1244	04DCh	Retry monitor 3 Output current	R	0 to 65535	0.01A
	1245	04DDh	Retry monitor 3 P-N DC voltage	R	0 to 10000	0.1VDC
	1246	04DEh	Retry monitor 3 Inverter state	R	0 to 8	1
	1247	04DFh	Retry monitor 3 LAD state	R	0 to 5	1
	1248	04E0h	Retry monitor 3 INV control mode	R	0 to 11	1
	1249	04E1h	Retry monitor 3 Limit state	R	0 to 6	1
	1250	04E2h	Retry monitor 3 Special state	R	0 to 6	1
	1252	04E4h	Retry monitor 3 RUN time (High)	R	0 to 1000000	1hr
	1253	04E5h	(Low)			
	1254	04E6h	Retry monitor 3 Power ON time (High)	R	0 to 1000000	1hr
	1255	04E7h	(Low)			
	1256	04E8h	Retry monitor 3 Absolute time (year, month)	R	00 - 99 (BCD code) 01 - 12 (BCD code)	1 1
	1257	04E9h	Retry monitor 3 Absolute time (day, day of the week)	R	01 - 31 (BCD code) 00 - 06 (BCD code)	1 1
1258	04EAh	Retry monitor 3 Absolute time (hour, minute)	R	00 - 23 (BCD code) 00 - 59 (BCD code)	1 1	
Retry monitor (dE-34)	1261	04EDh	Retry monitor 4 Factor	R	1 to 255	1
	1262	04EEh	Retry monitor 4 Output frequency (High)	R	-59000 to 59000	0.01Hz
	1263	04EFh	(with sign) (Low)			
	1264	04F0h	Retry monitor 4 Output current	R	0 to 65535	0.01A
	1265	04F1h	Retry monitor 4 P-N DC voltage	R	0 to 10000	0.1VDC
	1266	04F2h	Retry monitor 4 Inverter state	R	0 to 8	1
	1267	04F3h	Retry monitor 4 LAD state	R	0 to 5	1
	1268	04F4h	Retry monitor 4 INV control mode	R	0 to 11	1
	1269	04F5h	Retry monitor 4 Limit state	R	0 to 6	1
	1270	04F6h	Retry monitor 4 Special state	R	0 to 6	1
	1272	04F8h	Retry monitor 4 RUN time (High)	R	0 to 1000000	1hr
	1273	04F9h	(Low)			
	1274	04FAh	Retry monitor 4 Power ON time (High)	R	0 to 1000000	1hr
	1275	04FBh	(Low)			
	1276	04FCh	Retry monitor 4 Absolute time (year, month)	R	00 - 99 (BCD code) 01 - 12 (BCD code)	1 1
	1277	04FDh	Retry monitor 4 Absolute time (day, day of the week)	R	01 - 31 (BCD code) 00 - 06 (BCD code)	1 1
1278	04FEh	Retry monitor 4 Absolute time (hour, minute)	R	00 - 23 (BCD code) 00 - 59 (BCD code)	1 1	

Function Code	Register No. (decimal)	Register No. (hexadecimal)	Function Name	R/W	Monitor Content and Setting Item	Data Resolution / Unit
Retry monitor (dE-35)	1281	0501h	Retry monitor 5 Factor	R	1 to 255	1
	1282	0502h	Retry monitor 5 Output frequency (High)	R	-59000 to 59000	0.01Hz
	1283	0503h	(with sign) (Low)			
	1284	0504h	Retry monitor 5 Output current	R	0 to 65535	0.01A
	1285	0505h	Retry monitor 5 P-N DC voltage	R	0 to 10000	0.1VDC
	1286	0506h	Retry monitor 5 Inverter state	R	0 to 8	1
	1287	0507h	Retry monitor 5 LAD state	R	0 to 5	1
	1288	0508h	Retry monitor 5 INV control mode	R	0 to 11	1
	1289	0509h	Retry monitor 5 Limit state	R	0 to 6	1
	1290	050Ah	Retry monitor 5 Special state	R	0 to 6	1
	1292	050Ch	Retry monitor 5 RUN time (High)	R	0 to 1000000	1hr
	1293	050Dh	(Low)			
	1294	050Eh	Retry monitor 5 Power ON time (High)	R	0 to 1000000	1hr
	1295	050Fh	(Low)			
	1296	0510h	Retry monitor 5 Absolute time (year, month)	R	00 - 99 (BCD code) 01 - 12 (BCD code)	1 1
	1297	0511h	Retry monitor 5 Absolute time (day, day of the week)	R	01 - 31 (BCD code) 00 - 06 (BCD code)	1 1
1298	0512h	Retry monitor 5 Absolute time (hour, minute)	R	00 - 23 (BCD code) 00 - 59 (BCD code)	1 1	
Retry monitor (dE-36)	1301	0515h	Retry monitor 6 Factor	R	1 to 255	1
	1302	0516h	Retry monitor 6 Output frequency (High)	R	-59000 to 59000	0.01Hz
	1303	0517h	(with sign) (Low)			
	1304	0518h	Retry monitor 6 Output current	R	0 to 65535	0.01A
	1305	0519h	Retry monitor 6 P-N DC voltage	R	0 to 10000	0.1VDC
	1306	051Ah	Retry monitor 6 Inverter state	R	0 to 8	1
	1307	051Bh	Retry monitor 6 LAD state	R	0 to 5	1
	1308	051Ch	Retry monitor 6 INV control mode	R	0 to 11	1
	1309	051Dh	Retry monitor 6 Limit state	R	0 to 6	1
	1310	051Eh	Retry monitor 6 Special state	R	0 to 6	1
	1312	0520h	Retry monitor 6 RUN time (High)	R	0 to 1000000	1hr
	1313	0521h	(Low)			
	1314	0522h	Retry monitor 6 Power ON time (High)	R	0 to 1000000	1hr
	1315	0523h	(Low)			
	1316	0524h	Retry monitor 6 Absolute time (year, month)	R	00 - 99 (BCD code) 01 - 12 (BCD code)	1 1
	1317	0525h	Retry monitor 6 Absolute time (day, day of the week)	R	01 - 31 (BCD code) 00 - 06 (BCD code)	1 1
1318	0526h	Retry monitor 6 Absolute time (hour, minute)	R	00 - 23 (BCD code) 00 - 59 (BCD code)	1 1	

Function Code	Register No. (decimal)	Register No. (hexadecimal)	Function Name	R/W	Monitor Content and Setting Item	Data Resolution / Unit
Retry monitor (dE-37)	1321	0529h	Retry monitor 7 Factor	R	1 to 255	1
	1322	052Ah	Retry monitor 7 Output frequency (High)	R	-59000 to 59000	0.01Hz
	1323	052Bh	(with sign) (Low)			
	1324	052Ch	Retry monitor 7 Output current	R	0 to 65535	0.01A
	1325	052Dh	Retry monitor 7 P-N DC voltage	R	0 to 10000	0.1VDC
	1326	052Eh	Retry monitor 7 Inverter state	R	0 to 8	1
	1327	052Fh	Retry monitor 7 LAD state	R	0 to 5	1
	1328	0530h	Retry monitor 7 INV control mode	R	0 to 11	1
	1329	0531h	Retry monitor 7 Limit state	R	0 to 6	1
	1330	0532h	Retry monitor 7 Special state	R	0 to 6	1
	1332	0534h	Retry monitor 7 RUN time (High)	R	0 to 1000000	1hr
	1333	0535h	(Low)			
	1334	0536h	Retry monitor 7 Power ON time (High)	R	0 to 1000000	1hr
	1335	0537h	(Low)			
	1336	0538h	Retry monitor 7 Absolute time (year, month)	R	00 - 99 (BCD code) 01 - 12 (BCD code)	1 1
	1337	0539h	Retry monitor 7 Absolute time (day, day of the week)	R	01 - 31 (BCD code) 00 - 06 (BCD code)	1 1
1338	053Ah	Retry monitor 7 Absolute time (hour, minute)	R	00 - 23 (BCD code) 00 - 59 (BCD code)	1 1	
Retry monitor (dE-38)	1341	053Dh	Retry monitor 8 Factor	R	1 to 255	1
	1342	053Eh	Retry monitor 8 Output frequency (High)	R	-59000 to 59000	0.01Hz
	1343	053Fh	(with sign) (Low)			
	1344	0540h	Retry monitor 8 Output current	R	0 to 65535	0.01A
	1345	0541h	Retry monitor 8 P-N DC voltage	R	0 to 10000	0.1VDC
	1346	0542h	Retry monitor 8 Inverter state	R	0 to 8	1
	1347	0543h	Retry monitor 8 LAD state	R	0 to 5	1
	1348	0544h	Retry monitor 8 INV control mode	R	0 to 11	1
	1349	0545h	Retry monitor 8 Limit state	R	0 to 6	1
	1350	0546h	Retry monitor 8 Special state	R	0 to 6	1
	1352	0548h	Retry monitor 8 RUN time (High)	R	0 to 1000000	1hr
	1353	0549h	(Low)			
	1354	054Ah	Retry monitor 8 Power ON time (High)	R	0 to 1000000	1hr
	1355	054Bh	(Low)			
	1356	054Ch	Retry monitor 8 Absolute time (year, month)	R	00 - 99 (BCD code) 01 - 12 (BCD code)	1 1
	1357	054Dh	Retry monitor 8 Absolute time (day, day of the week)	R	01 - 31 (BCD code) 00 - 06 (BCD code)	1 1
1358	054Eh	Retry monitor 8 Absolute time (hour, minute)	R	00 - 23 (BCD code) 00 - 59 (BCD code)	1 1	

Function Code	Register No. (decimal)	Register No. (hexadecimal)	Function Name	R/W	Monitor Content and Setting Item	Data Resolution / Unit
Retry monitor (dE-39)	1361	0551h	Retry monitor 9 Factor	R	1 to 255	1
	1362	0552h	Retry monitor 9 Output frequency (High)	R	-59000 to 59000	0.01Hz
	1363	0553h	(with sign) (Low)			
	1364	0554h	Retry monitor 9 Output current	R	0 to 65535	0.01A
	1365	0555h	Retry monitor 9 P-N DC voltage	R	0 to 10000	0.1VDC
	1366	0556h	Retry monitor 9 Inverter state	R	0 to 8	1
	1367	0557h	Retry monitor 9 LAD state	R	0 to 5	1
	1368	0558h	Retry monitor 9 INV control mode	R	0 to 11	1
	1369	0559h	Retry monitor 9 Limit state	R	0 to 6	1
	1370	055Ah	Retry monitor 9 Special state	R	0 to 6	1
	1372	055Ch	Retry monitor 9 RUN time (High)	R	0 to 1000000	1hr
	1373	055Dh	(Low)			
	1374	055Eh	Retry monitor 9 Power ON time (High)	R	0 to 1000000	1hr
	1375	055Fh	(Low)			
	1376	0560h	Retry monitor 9 Absolute time (year, month)	R	00 - 99 (BCD code) 01 - 12 (BCD code)	1 1
1377	0561h	Retry monitor 9 Absolute time (day, day of the week)	R	01 - 31 (BCD code) 00 - 06 (BCD code)	1 1	
1378	0562h	Retry monitor 9 Absolute time (hour, minute)	R	00 - 23 (BCD code) 00 - 59 (BCD code)	1 1	
Retry monitor (dE-40)	1381	0565h	Retry monitor 10 Factor	R	1 to 255	1
	1382	0566h	Retry monitor 10 Output frequency (High)	R	-59000 to 59000	0.01Hz
	1383	0567h	(with sign) (Low)			
	1384	0568h	Retry monitor 10 Output current	R	0 to 65535	0.01A
	1385	0569h	Retry monitor 10 P-N DC voltage	R	0 to 10000	0.1VDC
	1386	056Ah	Retry monitor 10 Inverter state	R	0 to 8	1
	1387	056Bh	Retry monitor 10 LAD state	R	0 to 5	1
	1388	056Ch	Retry monitor 10 INV control mode	R	0 to 11	1
	1389	056Dh	Retry monitor 10 Limit state	R	0 to 6	1
	1390	056Eh	Retry monitor 10 Special state	R	0 to 6	1
	1392	0570h	Retry monitor 10 RUN time (High)	R	0 to 1000000	1hr
	1393	0571h	(Low)			
	1394	0572h	Retry monitor 10 Power ON time (High)	R	0 to 1000000	1hr
	1395	0573h	(Low)			
	1396	0574h	Retry monitor 10 Absolute time (year, month)	R	00 - 99 (BCD code) 01 - 12 (BCD code)	1 1
1397	0575h	Retry monitor 10 Absolute time (day, day of the week)	R	01 - 31 (BCD code) 00 - 06 (BCD code)	1 1	
1398	0576h	Retry monitor 10 Absolute time (hour, minute)	R	00 - 23 (BCD code) 00 - 59 (BCD code)	1 1	

(Warning)

Function Code	Register No. (decimal)	Register No. (hexadecimal)	Function Name	R/W	Monitor Content and Setting Item	Data Resolution / Unit
dE-50	1500	05DCh	Warning monitor	R	0 to 65535	1

(Writing, recalculation register)

Function Code	Register No. (decimal)	Register No. (hexadecimal)	Function Name	R/W	Monitor Content and Setting Item	Data Resolution / Unit
-	9000	2328h	ENTER instruction (Writing to Data Flash)	W	01: writing all parameters	1
-	9002	232Ah	1 register writing mode	W	01: enabled	1
-	9010	2332h	Motor constant recalculation (motor constant standard data not to be developed)	W	01: enabled	1

(Items other than parameter)

Function Code	Register No. (decimal)	Register No. (hexadecimal)	Function Name	R/W	Monitor Content and Setting Item	Data Resolution / Unit
-	10502	2906h	RS485 Set frequency (High)	R/W	-59000 to + 59000 (setting range is not the same with Ver1.xx.)	0.01Hz
-	10503	2907h	(Signed) (Common to main speed and auxiliary speed) (Low)			
-	10526	291Eh	RS485 Torque command	R/W	-5000 to 5000	0.1%
-	10530	2922h	RS485 Torque bias	R/W	-5000 to 5000	0.1%
-	10534	2926h	RS485 Torque control speed limit value (for forward rotation)	R/W	0 to 59000	0.01Hz
-	10535	2927h	RS485 Torque control speed limit value (for reverse rotation)	R/W	0 to 59000	0.01Hz
-	10546	2932h	RS485 PID target value (High)	R/W	-10000 to 10000	0.01%
-	10547	2933h	(Low)			
-	10554	293Ah	RS485 PID feedback data (High)	R/W	-10000 to 10000	0.01%
-	10555	293Bh	(Low)			
-	10566	2946h	RS485 Torque limit	R/W	0 to 5000	0.1%
-	16053	3EB5h	Output terminal function option output (OPO output)	R/W	0 to 0x7F	1
-	16060	3EBCh	Coil data 0 (coil No. 0000h - 000Fh)	R/W	0 to 0xFFFF	1
-	16061	3EBDh	Coil data 1 (coil No. 0010h - 001Fh)	R	0 to 0xFFFF	1
-	16062	3EBEh	Coil data 2 (coil No. 0020h - 002Fh)	R	0 to 0xFFFF	1
-	16063	3EBFh	Coil data 3 (coil No. 0030h - 003Fh)	R	0 to 0xFFFF	1
-	16064	3EC0h	Coil data 4 (coil No. 0040h - 004Fh)	R	0 to 0xFFFF	1

(Monitor + setting parameter (Code-F))

Function Code	Register No. (decimal)	Register No. (hexadecimal)	Function Name	R/W	Monitor Content and Setting Item	Data Resolution / Unit
FA-01	11001	2AF9h	Main speed reference setting or monitor	R/W	0 to 59000	0.01Hz
FA-02	11002	2AFAh	Sub-speed reference setting or monitor (High)	R/W	-59000 to +59000 (monitor) 0 to 59000 (setting) (Register No. and monitor range are not the same with Ver1.xx.)	0.01Hz
(FA-03)	11003	2AFBh	(Low)			
FA-10	11010	2B02h	Acceleration time setting or monitor (High)	R/W	0 to 360000	0.01s
(FA-11)	11011	2B03h	(Low)			
FA-12	11012	2B04h	Deceleration time setting or monitor (High)	R/W	0 to 360000	0.01s
(FA-13)	11013	2B05h	(Low)			
FA-15	11015	2B07h	Torque reference setting or monitor	R/W	-5000 to 5000	0.1%
FA-16	11016	2B08h	Torque bias setting or monitor	R/W	-5000 to 5000	0.1%
FA-20	11020	2B0Ch	Position reference setting or monitor (High)	R/W	-268435455 to 268435455 In high resolution mode: - 1073741823 to 1073741823	1
(FA-21)	11021	2B0Dh	(Low)			
FA-30	11030	2B16h	PID1 set-point 1 setting or monitor (High)	R/W	-10000 to 10000	Per AH-06 setting
(FA-31)	11031	2B17h	(Low)			
FA-32	11032	2B18h	PID1 set-point 2 setting or monitor (High)	R/W	-10000 to 10000	Per AH-06 setting
(FA-33)	11033	2B19h	(Low)			
FA-34	11034	2B1Ah	PID1 set-point 3 setting or monitor (High)	R/W	-10000 to 10000	Per AH-06 setting
(FA-35)	11035	2B1Bh	(Low)			
FA-36	11036	2B1Ch	PID2 set-point setting or monitor (High)	R/W	-10000 to 10000	Per AJ-06 setting
(FA-37)	11037	2B1Dh	(Low)			
FA-38	11038	2B1Eh	PID3 set-point setting or monitor (High)	R/W	-10000 to 10000	Per AJ-26 setting
(FA-39)	11039	2B1Fh	(Low)			
FA-40	11040	2B20h	PID4 set-point setting or monitor (High)	R/W	-10000 to 10000	Per AJ-46 setting
(FA-41)	11041	2B21h	(Low)			

(Setting parameter (Code-A, b, C, H, o, P, U))

Function Code	Register No. (decimal)	Register No. (hexadecimal)	Function Name	R/W	Monitor Content and Setting Item	Data Resolution / Unit
AA101	12001	2EE1h	Main speed input source selection, 1st-motor	R/W	1 to 16	1
AA102	12002	2EE2h	Sub speed input source selection, 1st-motor	R/W	0 to 16	1
AA104	12004	2EE4h	Sub speed setting, 1st-motor	R/W	0 to 59000	0.01Hz
AA105	12005	2EE5h	Speed reference calculation symbol selection, 1st-motor	R/W	0 to 3	1
AA106	12006	2EE6h	Add frequency setting, 1st-motor (High)	R/W	-59000 to 59000	0.01Hz
(AA107)	12007	2EE7h	(Low)			
AA111	12011	2EEBh	RUN command input source selection, 1st-motor	R/W	0 to 6	1
AA-12	12012	2EECh	RUN-key command rotation direction	R/W	0 to 1	1
AA-13	12013	2EEDh	STOP-key enable	R/W	0 to 2	1
AA114	12014	2EEeh	RUN direction restriction, 1st-motor	R/W	0 to 2	1
AA115	12015	2EEfh	STOP mode selection, 1st-motor	R/W	0 to 1	1
AA121	12021	2EF5h	Control mode selection, 1st-motor	R/W	0 to 12	1
AA123	12023	2EF7h	Vector control mode selection, 1st-motor	R/W	0 to 3	1
AA201	22001	55F1h	Main speed input source selection, 2nd-motor	R/W	1 to 16	1
AA202	22002	55F2h	Sub speed input source selection, 2nd-motor	R/W	0 to 16	1
AA204	22004	55F4h	Sub speed setting, 2nd-motor	R/W	0 to 59000	0.01Hz
AA205	22005	55F5h	Speed reference calculation symbol selection, 2nd-motor	R/W	0 to 3	1
AA206	22006	55F6h	Add frequency setting, 2nd-motor (High)	R/W	-59000 to 59000	0.01Hz
(AA207)	22007	55F7h	(Low)			
AA211	22011	55FBh	RUN command input source selection, 2nd-motor	R/W	0 to 6	1
AA214	22014	55FEh	RUN-direction restriction selection, 2nd-motor	R/W	0 to 2	1
AA215	22015	55FFh	STOP mode selection, 2nd-motor	R/W	0 to 1	1
AA221	22021	5605h	Control mode selection 2nd-motor	R/W	0 to 11	1
AA223	22023	5607h	Vector control mode selection, 2nd-motor	R/W	0 to 3	1
Ab-01	12101	2F45h	Frequency conversion gain	R/W	1 to 10000	0.01
Ab-03	12103	2F47h	Multi-speed operation selection	R/W	0 to 1	1
Ab110	12110	2F4Eh	Multi-speed 0 setting, 1st-motor	R/W	0 to 59000	0.01Hz
Ab-11	12111	2F4Fh	Multi-speed 1 setting	R/W	0 to 59000	0.01Hz
Ab-12	12112	2F50h	Multi-speed 2 setting	R/W	0 to 59000	0.01Hz
Ab-13	12113	2F51h	Multi-speed 3 setting	R/W	0 to 59000	0.01Hz
Ab-14	12114	2F52h	Multi-speed 4 setting	R/W	0 to 59000	0.01Hz
Ab-15	12115	2F53h	Multi-speed 5 setting	R/W	0 to 59000	0.01Hz
Ab-16	12116	2F54h	Multi-speed 6 setting	R/W	0 to 59000	0.01Hz
Ab-17	12117	2F55h	Multi-speed 7 setting	R/W	0 to 59000	0.01Hz
Ab-18	12118	2F56h	Multi-speed 8 setting	R/W	0 to 59000	0.01Hz
Ab-19	12119	2F57h	Multi-speed 9 setting	R/W	0 to 59000	0.01Hz
Ab-20	12120	2F58h	Multi-speed 10 setting	R/W	0 to 59000	0.01Hz
Ab-21	12121	2F59h	Multi-speed 11 setting	R/W	0 to 59000	0.01Hz
Ab-22	12122	2F5Ah	Multi-speed 12 setting	R/W	0 to 59000	0.01Hz
Ab-23	12123	2F5Bh	Multi-speed 13 setting	R/W	0 to 59000	0.01Hz
Ab-24	12124	2F5Ch	Multi-speed 14 setting	R/W	0 to 59000	0.01Hz
Ab-25	12125	2F5Dh	Multi-speed 15 setting	R/W	0 to 59000	0.01Hz
Ab210	22110	565Eh	Multi-speed 0 setting, 2nd-motor	R/W	0 to 59000	0.01Hz

Function Code	Register No. (decimal)	Register No. (hexadecimal)	Function Name	R/W	Monitor Content and Setting Item	Data Resolution / Unit
AC-01	12201	2FA9h	Acceleration/Deceleration time input source selection	R/W	0 to 4	1
AC-02	12202	2FAAh	Acceleration/Deceleration selection	R/W	0 to 1	1
AC-03	12203	2FABh	Acceleration curve selection	R/W	0 to 4	1
AC-04	12204	2FACh	Deceleration curve selection	R/W	0 to 4	1
AC-05	12205	2FADh	Acceleration curve constant setting	R/W	1 to 10	1
AC-06	12206	2FAEh	Deceleration curve constant setting	R/W	1 to 10	1
AC-08	12208	2FB0h	EL-S-curve ratio @start of acceleration	R/W	0 to 100	1%
AC-09	12209	2FB1h	EL-S-curve ratio @end of acceleration	R/W	0 to 100	1%
AC-10	12210	2FB2h	EL-S-curve ratio @start of deceleration	R/W	0 to 100	1%
AC-11	12211	2FB3h	EL-S-curve ratio @end of deceleration	R/W	0 to 100	1%
AC115	12215	2FB7h	Accel/Decel change trigger, 1st-motor	R/W	0 to 2	1
AC116	12216	2FB8h	Accel1 to Accel2 frequency transition point, 1st-motor	R/W	0 to 59000	0.01Hz
AC117	12217	2FB9h	Decel1 to Decel2 frequency transition point, 1st-motor	R/W	0 to 59000	0.01Hz
AC120	12220	2FBC	Acceleration time setting 1, (High)	R/W	0 to 360000	0.01s
(AC121)	12221	2FBD	(Low)			
AC122	12222	2FBE	Deceleration time setting 1, (High)	R/W	0 to 360000	0.01s
(AC123)	12223	2FBF	(Low)			
AC124	12224	2FC0	Acceleration time setting 2, (High)	R/W	0 to 360000	0.01s
(AC125)	12225	2FC1	(Low)			
AC126	12226	2FC2	Deceleration time setting 2, (High)	R/W	0 to 360000	0.01s
(AC127)	12227	2FC3	(High)			
AC-30	12230	2FC6	Accel. time for Multi-speed 1 (High)	R/W	0 to 360000	0.01s
(AC-31)	12231	2FC7	(Low)			
AC-32	12232	2FC8	Decel. time for Multi-speed 1 (High)	R/W	0 to 360000	0.01s
(AC-33)	12233	2FC9	(Low)			
AC-34	12234	2FCA	Accel. time for Multi-speed 2 (High)	R/W	0 to 360000	0.01s
(AC-35)	12235	2FCB	(Low)			
AC-36	12236	2FC	Decel. time for Multi-speed 2 (High)	R/W	0 to 360000	0.01s
(AC-37)	12237	2FCD	(Low)			
AC-38	12238	2FCE	Accel. time for Multi-speed 3 (High)	R/W	0 to 360000	0.01s
(AC-39)	12239	2FCF	(Low)			
AC-40	12240	2FD0	Decel. time for Multi-speed 3 (High)	R/W	0 to 360000	0.01s
(AC-41)	12241	2FD1	(Low)			
AC-42	12242	2FD2	Accel. time for Multi-speed 4 (High)	R/W	0 to 360000	0.01s
(AC-43)	12243	2FD3	(Low)			
AC-44	12244	2FD4	Decel. time for Multi-speed 4 (High)	R/W	0 to 360000	0.01s
(AC-45)	12245	2FD5	(Low)			
AC-46	12246	2FD6	Accel. time for Multi-speed 5 (High)	R/W	0 to 360000	0.01s
(AC-47)	12247	2FD7	(Low)			
AC-48	12248	2FD8	Decel. time for Multi-speed 5 (High)	R/W	0 to 360000	0.01s
(AC-49)	12249	2FD9	(Low)			
AC-50	12250	2FDA	Accel. time for Multi-speed 6 (High)	R/W	0 to 360000	0.01s
(AC-51)	12251	2FDB	(Low)			
AC-52	12252	2FDC	Decel. time for Multi-speed 6 (High)	R/W	0 to 360000	0.01s
(AC-53)	12253	2FDD	(Low)			

Function Code	Register No. (decimal)	Register No. (hexadecimal)	Function Name	R/W	Monitor Content and Setting Item	Data Resolution / Unit
AC-54 (AC-55)	12254 12255	2FDEh 2FDFh	Accel. time for Multi-speed 7 (High) (Low)	R/W	0 to 360000	0.01s
AC-56 (AC-57)	12256 12257	2FE0h 2FE1h	Decel. time for Multi-speed 7 (High) (Low)	R/W	0 to 360000	0.01s
AC-58 (AC-59)	12258 12259	2FE2h 2FE3h	Accel. time for Multi-speed 8 (High) (Low)	R/W	0 to 360000	0.01s
AC-60 (AC-61)	12260 12261	2FE4h 2FE5h	Decel. time for Multi-speed 8 (High) (Low)	R/W	0 to 360000	0.01s
AC-62 (AC-63)	12262 12263	2FE6h 2FE7h	Accel. time for Multi-speed 9 (High) (Low)	R/W	0 to 360000	0.01s
AC-64 (AC-65)	12264 12265	2FE8h 2FE9h	Decel. time for Multi-speed 9 (High) (Low)	R/W	0 to 360000	0.01s
AC-66 (AC-67)	12266 12267	2FEAh 2FEBh	Accel. time for Multi-speed 10 (High) (Low)	R/W	0 to 360000	0.01s
AC-68 (AC-69)	12268 12269	2FEC h 2FEDh	Decel. time for Multi-speed 10 (High) (Low)	R/W	0 to 360000	0.01s
AC-70 (AC-71)	12270 12271	2FEEh 2FEFh	Accel. time for Multi-speed 11 (High) (Low)	R/W	0 to 360000	0.01s
AC-72 (AC-73)	12272 12273	2FF0h 2FF1h	Decel. time for Multi-speed 11 (High) (Low)	R/W	0 to 360000	0.01s
AC-74 (AC-75)	12274 12275	2FF2h 2FF3h	Accel. time for Multi-speed 12 (High) (Low)	R/W	0 to 360000	0.01s
AC-76 (AC-77)	12276 12277	2FF4h 2FF5h	Decel. time for Multi-speed 12 (High) (Low)	R/W	0 to 360000	0.01s
AC-78 (AC-79)	12278 12279	2FF6h 2FF7h	Accel. time for Multi-speed 13 (High) (Low)	R/W	0 to 360000	0.01s
AC-80 (AC-81)	12280 12281	2FF8h 2FF9h	Decel. time for Multi-speed 13 (High) (Low)	R/W	0 to 360000	0.01s
AC-82 (AC-83)	12282 12283	2FFAh 2FFBh	Accel. time for Multi-speed 14 (High) (Low)	R/W	0 to 360000	0.01s
AC-84 (AC-85)	12284 12285	2FFCh 2FFDh	Decel. time for Multi-speed 14 (High) (Low)	R/W	0 to 360000	0.01s
AC-86 (AC-87)	12286 12287	2FFEh 2FFFh	Accel. time for Multi-speed 15 (High) (Low)	R/W	0 to 360000	0.01s
AC-88 (AC-89)	12288 12289	3000h 3001h	Decel. time for Multi-speed 15 (High) (Low)	R/W	0 to 360000	0.01s
AC215	22215	56C7h	Accel/Decel change trigger, 2nd-motor	R/W	0 to 2	1
AC216	22216	56C8h	Accel1 to Accel2 frequency transition point, 2nd-motor	R/W	0 to 59000	0.01Hz
AC217	22217	56C9h	Decel1 to Decel2 frequency transition point, 2nd-motor	R/W	0 to 59000	0.01Hz
AC220 (AC221)	22220 22221	56CCh 56CDh	Acceleration time 1, 2nd-motor (High) (Low)	R/W	0 to 360000	0.01s
AC222 (AC223)	22222 22223	56Ceh 56CFh	Deceleration time 1, 2nd-motor (High) (Low)	R/W	0 to 360000	0.01s
AC224 (AC225)	22224 22225	56D0h 56D1h	Acceleration time 2, 2nd-motor (High) (Low)	R/W	0 to 360000	0.01s
AC226 (AC227)	22226 22227	56D2h 56D3h	Deceleration time 2, 2nd-motor (High) (Low)	R/W	0 to 360000	0.01s

Function Code	Register No. (decimal)	Register No. (hexadecimal)	Function Name	R/W	Monitor Content and Setting Item	Data Resolution / Unit
Ad-01	12301	300Dh	Torque reference input source selection	R/W	1 to 13, 15	1
Ad-02	12302	300Eh	Torque reference value setting	R/W	-5000 to 5000	0.1%
Ad-03	12303	300Fh	Polarity selection for torque reference	R/W	0 to 1	1
Ad-04	12304	3010h	Switching time of speed control to torque control	R/W	0 to 1000	1ms
Ad-11	12311	3017h	Torque bias input source selection	R/W	0 to 13, 15	1
Ad-12	12312	3018h	Torque bias value setting	R/W	-5000 to 5000	0.1%
Ad-13	12313	3019h	Torque bias polarity	R/W	0 to 1	1
Ad-14	12314	301Ah	Enable terminal [TBS]	R/W	0 to 1	1
Ad-40	12340	3034h	Speed limit input source selection at torque control	R/W	1 to 13	1
Ad-41	12341	3035h	Speed limit at torque control (at Forward rotation)	R/W	0 to 59000	0.01Hz
Ad-42	12342	3036h	Speed limit at torque control (at Reverse rotation)	R/W	0 to 59000	0.01Hz
AE-01	12401	3071h	Electronic gear setting point selection	R/W	0 to 1	1
AE-02	12402	3072h	Electronic gear ratio numerator	R/W	1 to 10000	1
AE-03	12403	3073h	Electronic gear ratio denominator	R/W	1 to 10000	1
AE-04	12404	3074h	Positioning completed range setting	R/W	0 to 10000	1pls
AE-05	12405	3075h	Positioning completed delay time setting	R/W	0 to 1000	0.01s
AE-06	12406	3076h	Position feedforward gain setting	R/W	0 to 65535	0.01
AE-07	12407	3077h	Position loop gain setting	R/W	0 to 10000	0.01
AE-08	12408	3078h	Position bias setting	R/W	-2048 to 2048	1pls
AE-10	12410	307Ah	Stop position selection of home search function	R/W	0 to 3	1
AE-11	12411	307Bh	Stop position of home search function	R/W	0 to 4095	1
AE-12	12412	307Ch	Speed reference of home search function	R/W	0 to 12000	0.01Hz
AE-13	12413	307Dh	Direction of home search function	R/W	0 to 1	1
AE-20	12420	3084h	Position reference 0 (High)	R/W	-268435455 to 268435455 In high resolution mode: -1073741823 to 1073741823	1pls
(AE-21)	12421	3085h	(Low)			
AE-22	12422	3086h	Position reference 1 (High)	R/W	-268435455 to 268435455 In high resolution mode: -1073741823 to 1073741823	1pls
(AE-23)	12423	3087h	(Low)			
AE-24	12424	3088h	Position reference 2 (High)	R/W	-268435455 to 268435455 In high resolution mode: -1073741823 to 1073741823	1pls
(AE-25)	12425	3089h	(Low)			
AE-26	12426	308Ah	Position reference 3 (High)	R/W	-268435455 to 268435455 In high resolution mode: -1073741823 to 1073741823	1pls
(AE-27)	12427	308Bh	(Low)			
AE-28	12428	308Ch	Position reference 4 (High)	R/W	-268435455 to 268435455 In high resolution mode: -1073741823 to 1073741823	1pls
(AE-29)	12429	308Dh	(Low)			
AE-30	12430	308Eh	Position reference 5 (High)	R/W	-268435455 to 268435455 In high resolution mode: -1073741823 to 1073741823	1pls
(AE-31)	12431	308Fh	(Low)			
AE-32	12432	3090h	Position reference 6 (High)	R/W	-268435455 to 268435455 In high resolution mode: -1073741823 to 1073741823	1pls
(AE-33)	12433	3091h	(Low)			
AE-34	12434	3092h	Position reference 7 (High)	R/W	-268435455 to 268435455 In high resolution mode: -1073741823 to 1073741823	1pls
(AE-35)	12435	3093h	(Low)			
AE-36	12436	3094h	Position reference 8 (High)	R/W	-268435455 to 268435455 In high resolution mode: -1073741823 to 1073741823	1pls
(AE-37)	12437	3095h	(Low)			

Function Code	Register No. (decimal)	Register No. (hexadecimal)	Function Name	R/W	Monitor Content and Setting Item	Data Resolution / Unit
AE-38	12438	3096h	Position reference 9 (High)	R/W	-268435455 to 268435455 In high resolution mode: -1073741823 to 1073741823	1pls
(AE-39)	12439	3097h	(Low)			
AE-40	12440	3098h	Position reference 10 (High)	R/W	-268435455 to 268435455 In high resolution mode: -1073741823 to 1073741823	1pls
(AE-41)	12441	3099h	(Low)			
AE-42	12442	309Ah	Position reference 11 (High)	R/W	-268435455 to 268435455 In high resolution mode: -1073741823 to 1073741823	1pls
(AE-43)	12443	309Bh	(Low)			
AE-44	12444	309Ch	Position reference 12 (High)	R/W	-268435455 to 268435455 In high resolution mode: -1073741823 to 1073741823	1pls
(AE-45)	12445	309Dh	(Low)			
AE-46	12446	309Eh	Position reference 13 (High)	R/W	-268435455 to 268435455 In high resolution mode: -1073741823 to 1073741823	1pls
(AE-47)	12447	309Fh	(Low)			
AE-48	12448	30A0h	Position reference 14 (High)	R/W	-268435455 to 268435455 In high resolution mode: -1073741823 to 1073741823	1pls
(AE-49)	12449	30A1h	(Low)			
AE-50	12450	30A2h	Position reference 15 (High)	R/W	-268435455 to 268435455 In high resolution mode: -1073741823 to 1073741823	1pls
(AE-51)	12451	30A3h	(Low)			
AE-52	12452	30A4h	Position control range setting (forward) (High)	R/W	0 to 268435455 In high resolution mode: 0 to 1073741823	1pls
(AE-53)	12453	30A5h	(Low)			
AE-54	12454	30A6h	Position control range setting (reverse) (High)	R/W	-268435455 to 0 In high resolution mode: -1073741823 to 0	1pls
(AE-55)	12455	30A7h	(Low)			
AE-56	12456	30A8h	Position control mode selection	R/W	0 to 1	1
AE-60	12460	30Ach	Teach-in function target selection	R/W	0 to 15	1
AE-61	12461	30Adh	Save current position at power off	R/W	0 to 1	1
AE-62	12462	30Aeh	Pre-set position data (High)	R/W	-268435455 to 268435455 In high resolution mode: -1073741823 to 1073741823	1pls
(AE-63)	12463	30Afh	(Low)			
AE-64	12464	30B0h	Deceleration stop distance calculation gain	R/W	5000 to 20000	0.01%
AE-65	12465	30B1h	Deceleration stop distance calculation bias	R/W	0 to 65535	0.01%
AE-66	12466	30B2h	Speed limit in APR control	R/W	0 to 10000	0.01%
AE-67	12467	30B3h	APR start speed	R/W	0 to 10000	0.01%
AE-70	12470	30B6h	Homing function selection	R/W	0 to 2	1
AE-71	12471	30B7h	Direction of homing function	R/W	0 to 1	1
AE-72	12472	30B8h	Low-speed homing speed setting	R/W	0 to 1000	0.01Hz
AE-73	12473	30B9h	High-speed homing speed setting	R/W	0 to 59000	0.01Hz

Function Code	Register No. (decimal)	Register No. (hexadecimal)	Function Name	R/W	Monitor Content and Setting Item	Data Resolution / Unit
AF101	12501	30D5h	DC braking selection, 1st-motor	R/W	0 to 2	1
AF102	12502	30D6h	Braking type selection, 1st-motor	R/W	0 to 2	1
AF103	12503	30D7h	DC braking frequency, 1st-motor	R/W	0 to 59000	0.01Hz
AF104	12504	30D8h	DC braking delay time, 1st-motor	R/W	0 to 500	0.01s
AF105	12505	30D9h	DC braking force setting, 1st-motor	R/W	0 to 100	1%
AF106	12506	30Dah	DC braking active time at stop, 1st-motor	R/W	0 to 6000	0.01s
AF107	12507	30DBh	DC braking operation method selection, 1st-motor	R/W	0 to 1	1
AF108	12508	30DCh	DC braking force at start, 1st-motor	R/W	0 to 100	1%
AF109	12509	30DDh	DC braking active time at start, 1st-motor	R/W	0 to 6000	0.01s
AF120	12520	30E8h	Contact control enable, 1st-motor	R/W	0 to 2	1
AF121	12521	30E9h	Run delay time, 1st-motor	R/W	0 to 200	0.01s
AF122	12522	30Eah	Contact off delay time, 1st-motor	R/W	0 to 200	0.01s
AF123	12523	30Ebh	Contact response check time, 1st-motor	R/W	0 to 500	0.01s
AF130	12530	30F2h	Brake control enable, 1st-motor	R/W	0 to 3	1
AF131	12531	30F3h	Brake release wait time, 1st-motor (Forward)	R/W	0 to 500	0.01s
AF132	12532	30F4h	Brake wait time for accel., 1st-motor (Forward)	R/W	0 to 500	0.01s
AF133	12533	30F5h	Brake wait time for stopping, 1st-motor (Forward)	R/W	0 to 500	0.01s
AF134	12534	30F6h	Brake confirmation signal wait time, 1st-motor (Forward)	R/W	0 to 500	0.01s
AF135	12535	30F7h	Brake release frequency setting, 1st-motor (Forward)	R/W	0 to 59000	0.01Hz
AF136	12536	30F8h	Brake release current setting, 1st-motor (Forward)	R/W	(0 to 2.00)*rated current 0 to 20000 *1)	0.1A 0.01%
AF137	12537	30F9h	Braking frequency, 1st-motor (Forward)	R/W	0 to 59000	0.01Hz
AF138	12538	30Fah	Brake release wait time, 1st-motor (Reverse)	R/W	0 to 500	0.01s
AF139	12539	30FBh	Brake wait time for accel., 1st-motor (Reverse)	R/W	0 to 500	0.01s
AF140	12540	30FCh	Brake wait time for stopping, 1st-motor (Reverse)	R/W	0 to 500	0.01s
AF141	12541	30FDh	Brake confirmation signal wait time, 1st-motor (Reverse)	R/W	0 to 500	0.01s
AF142	12542	30Feh	Brake release frequency setting, 1st-motor (Reverse)	R/W	0 to 59000	0.01Hz
AF143	12543	30FFh	Brake release current setting, 1st-motor (Reverse)	R/W	(0 to 2.00)*rated current 0 to 20000 *1)	0.1A 0.01%
AF144	12544	3100h	Braking frequency, 1st-motor (Reverse)	R/W	0 to 59000	0.01Hz
AF150	12550	3106h	Brake open delay time, 1st-motor	R/W	0 to 200	0.01s
AF151	12551	3107h	Brake close delay time, 1st-motor	R/W	0 to 200	0.01s
AF152	12552	3108h	Brake response check time, 1st-motor	R/W	0 to 500	0.01s
AF153	12553	3109h	Servo lock/ DC injection time at start, 1st-motor	R/W	0 to 1000	0.01s
AF154	12554	310Ah	Servo lock/ DC injection time at stop, 1st-motor	R/W	0 to 1000	0.01s
AF201	22501	57E5h	DC braking selection, 2nd-motor	R/W	0 to 2	1
AF202	22502	57E6h	Braking type selection, 2nd-motor	R/W	0 to 2	1
AF203	22503	57E7h	DC braking frequency, 2nd-motor	R/W	0 to 59000	0.01Hz
AF204	22504	57E8h	DC braking delay time, 2nd-motor	R/W	0 to 500	0.01s
AF205	22505	57E9h	DC braking force setting, 2nd-motor	R/W	0 to 100	1%
AF206	22506	57Eah	DC braking active time at stop, 2nd-motor	R/W	0 to 6000	0.01s
AF207	22507	57Ebh	DC braking operation method selection, 2nd-motor	R/W	0 to 1	1
AF208	22508	57Ech	DC braking force at start, 2nd-motor	R/W	0 to 100	1%
AF209	22509	57Edh	DC braking active time at start, 2nd-motor	R/W	0 to 6000	0.01s
AF220	22520	57F8h	Contact control enable, 2nd-motor	R/W	0 to 2	1
AF221	22521	57F9h	Run delay time, 2nd-motor	R/W	0 to 200	0.01s
AF222	22522	57Fah	Contact off delay time, 2nd-motor	R/W	0 to 200	0.01s
AF223	22523	57FBh	Contact response check time, 2nd-motor	R/W	0 to 500	0.01s

*1) It is in case selected "%" at parameter [CF-11].

Function Code	Register No. (decimal)	Register No. (hexadecimal)	Function Name	R/W	Monitor Content and Setting Item	Data Resolution / Unit
AF230	22530	5802h	Brake control enable, 2nd-motor	R/W	0 to 3	1
AF231	22531	5803h	Brake release wait time, 2nd-motor (Forward)	R/W	0 to 500	0.01s
AF232	22532	5804h	Brake wait time for accel., 2nd-motor (Forward)	R/W	0 to 500	0.01s
AF233	22533	5805h	Brake wait time for stopping, 2nd-motor (Forward)	R/W	0 to 500	0.01s
AF234	22534	5806h	Brake confirmation signal wait time, 2nd-motor (Forward)	R/W	0 to 500	0.01s
AF235	22535	5807h	Brake release frequency setting, 2nd-motor (Forward)	R/W	0 to 59000	0.01Hz
AF236	22536	5808h	Brake release current setting, 2nd-motor (Forward)	R/W	(0 to 2.00) * CTL rated current	0.1A
					0 to 20000 *1)	0.01%
AF237	22537	5809h	Braking frequency, 2nd-motor (Forward)	R/W	0 to 59000	0.01Hz
AF238	22538	580Ah	Brake release wait time, 2nd-motor (Reverse)	R/W	0 to 500	0.01s
AF239	22539	580Bh	Brake wait time for accel., 2nd-motor (Reverse)	R/W	0 to 500	0.01s
AF240	22540	580Ch	Brake wait time for stopping, 2nd-motor (Reverse)	R/W	0 to 500	0.01s
AF241	22541	580Dh	Brake confirmation signal wait time, 2nd-motor (Reverse)	R/W	0 to 500	0.01s
AF242	22542	580Eh	Brake release frequency setting, 2nd-motor (Reverse)	R/W	0 to 59000	0.01Hz
AF243	22543	580Fh	Brake release current setting, 2nd-motor (Reverse)	R/W	(0 to 2.00) * CTL rated current	0.1A
					0 to 20000 *1)	0.01%
AF244	22544	5810h	Braking frequency, 2nd-motor (Reverse side)	R/W	0 to 59000	0.01Hz
AF250	22550	5816h	Brake open delay time, 2nd-motor	R/W	0 to 200	0.01s
AF251	22551	5817h	Brake close delay time, 2nd-motor	R/W	0 to 200	0.01s
AF252	22552	5818h	Brake response check time, 2nd-motor	R/W	0 to 500	0.01s
AF253	22553	5819h	Servo lock/DC injection time at start, 2nd-motor	R/W	0 to 1000	0.01s
AF254	22554	581Ah	Servo lock/DC injection time at stop, 2nd-motor	R/W	0 to 1000	0.01s
AG101	12601	3139h	Jump frequency 1, 1st-motor	R/W	0 to 59000	0.01Hz
AG102	12602	313Ah	Jump frequency width 1, 1st-motor	R/W	0 to 1000	0.01Hz
AG103	12603	313Bh	Jump frequency 2, 1st-motor	R/W	0 to 59000	0.01Hz
AG104	12604	313Ch	Jump frequency width 2, 1st-motor	R/W	0 to 1000	0.01Hz
AG105	12605	313Dh	Jump frequency 3, 1st-motor	R/W	0 to 59000	0.01Hz
AG106	12606	313Eh	Jump frequency width 3, 1st-motor	R/W	0 to 1000	0.01Hz
AG110	12610	3142h	Acceleration stop frequency setting, 1st-motor	R/W	0 to 59000	0.01Hz
AG111	12611	3143h	Acceleration stop time setting, 1st-motor	R/W	0 to 600	0.1s
AG112	12612	3144h	Deceleration stop frequency setting, 1st-motor	R/W	0 to 59000	0.01Hz
AG113	12613	3145h	Deceleration stop time setting, 1st-motor	R/W	0 to 600	0.1s
AG-20	12620	314Ch	Jogging frequency	R/W	0 to 1000	0.01Hz
AG-21	12621	314Dh	Jogging stop mode selection	R/W	0 to 5	1
AG201	22601	5849h	Jump frequency 1, 2nd-motor	R/W	0 to 59000	0.01Hz
AG202	22602	584Ah	Jump frequency width 1, 2nd-motor	R/W	0 to 1000	0.01Hz
AG203	22603	584Bh	Jump frequency 2, 2nd-motor	R/W	0 to 59000	0.01Hz
AG204	22604	584Ch	Jump frequency width 2, 2nd-motor	R/W	0 to 1000	0.01Hz
AG205	22605	584Dh	Jump frequency 3, 2nd-motor	R/W	0 to 59000	0.01Hz
AG206	22606	584Eh	Jump frequency width 3, 2nd-motor	R/W	0 to 1000	0.01Hz
AG210	22610	5852h	Acceleration stop frequency setting, 2nd-motor	R/W	0 to 59000	0.01Hz
AG211	22611	5853h	Acceleration stop time setting 2nd-motor	R/W	0 to 600	0.1s
AG212	22612	5854h	Deceleration stop frequency setting, 2nd-motor	R/W	0 to 59000	0.01Hz
AG213	22613	5855h	Deceleration stop time setting, 2nd-motor	R/W	0 to 600	0.1s

*1) It is in case selected "%" at parameter [CF-11].

Function Code	Register No. (decimal)	Register No. (hexadecimal)	Function Name	R/W	Monitor Content and Setting Item	Data Resolution / Unit
AH-01	12701	319Dh	PID1 enable	R/W	0 to 2	1
AH-02	12702	319Eh	PID1 deviation inversion	R/W	0 to 1	1
AH-03	12703	319Fh	Unit selection for PID1	R/W	0 to 58	1
AH-04	12704	31A0h	PID1 adjustment (0%)	R/W	-10000 to 10000	1
AH-05	12705	31A1h	PID1 adjustment (100%)	R/W	-10000 to 10000	1
AH-06	12706	31A2h	PID1 Adjustment (decimal point position)	R/W	0 to 4	1
AH-07	12707	31A3h	PID1 set-point 1 input source selection	R/W	0 to 13	1
AH-10	12710	31A6h	PID1 set-point-1 setting (High)	R/W	-10000 – 10000	Per AH-06 setting
(AH-11)	12711	31A7h	(Low)			
AH-12	12712	31A8h	PID1 multistage set-point 1 (High)	R/W	-10000 – 10000	Per AH-06 setting
(AH-13)	12713	31A9h	(Low)			
AH-14	12714	31Aah	PID1 multistage set-point 2 (High)	R/W	-10000 – 10000	Per AH-06 setting
(AH-15)	12715	31Abh	(Low)			
AH-16	12716	31Ach	PID1 multistage set-point 3 (High)	R/W	-10000 – 10000	Per AH-06 setting
(AH-17)	12717	31Adh	(Low)			
AH-18	12718	31Aeh	PID1 multistage set-point 4 (High)	R/W	-10000 – 10000	Per AH-06 setting
(AH-19)	12719	31Afh	(Low)			
AH-20	12720	31B0h	PID1 multistage set-point 5 (High)	R/W	-10000 – 10000	Per AH-06 setting
(AH-21)	12721	31B1h	(Low)			
AH-22	12722	31B2h	PID1 multistage set-point 6 (High)	R/W	-10000 – 10000	Per AH-06 setting
(AH-23)	12723	31B3h	(Low)			
AH-24	12724	31B4h	PID1 multistage set-point 7 (High)	R/W	-10000 – 10000	Per AH-06 setting
(AH-25)	12725	31B5h	(Low)			
AH-26	12726	31B6h	PID1 multistage set-point 8 (High)	R/W	-10000 – 10000	Per AH-06 setting
(AH-27)	12727	31B7h	(Low)			
AH-28	12728	31B8h	PID1 multistage set-point 9 (High)	R/W	-10000 – 10000	Per AH-06 setting
(AH-29)	12729	31B9h	(Low)			
AH-30	12730	31Bah	PID1 multistage set-point 10 (High)	R/W	-10000 – 10000	Per AH-06 setting
(AH-31)	12731	31BBh	(Low)			
AH-32	12732	31BCh	PID1 multistage set-point 11 (High)	R/W	-10000 – 10000	Per AH-06 setting
(AH-33)	12733	31BDh	(Low)			
AH-34	12734	31Beh	PID1 multistage set-point 12 (High)	R/W	-10000 – 10000	Per AH-06 setting
(AH-35)	12735	31BFh	(Low)			
AH-36	12736	31C0h	PID1 multistage set-point 13 (High)	R/W	-10000 – 10000	Per AH-06 setting
(AH-37)	12737	31C1h	(Low)			
AH-38	12738	31C2h	PID1 multistage set-point 14 (High)	R/W	-10000 – 10000	Per AH-06 setting
(AH-39)	12739	31C3h	(Low)			
AH-40	12740	31C4h	PID1 multistage set-point 15 (High)	R/W	-10000 – 10000	Per AH-06 setting
(AH-41)	12741	31C5h	(Low)			
AH-42	12742	31C6h	PID1 set-point 2 input source selection	R/W	0 – 13	1
AH-44	12744	31C8h	PID1 set-point 2 setting (High)	R/W	-10000 – 10000	Per AH-06 setting
(AH-45)	12745	31C9h	(Low)			
AH-46	12746	31Cah	PID1 set-point 3 input source selection	R/W	0 to 13	1
AH-48	12748	31CCh	PID1 set-point 3 setting (High)	R/W	-10000 to 10000	Per AH-06 setting
(AH-49)	12749	31CDh	(Low)			

Function Code	Register No. (decimal)	Register No. (hexadecimal)	Function Name	R/W	Monitor Content and Setting Item	Data Resolution / Unit
AH-50	12750	31Ceh	PID1 set-point calculation symbol selection	R/W	1 to 6	1
AH-51	12751	31CFh	PID1 feedback 1 input source selection	R/W	0 to 6, 8 to 13	1
AH-52	12752	31D0h	PID1 feedback 2 input source selection	R/W	0 to 6, 8 to 13	1
AH-53	12753	31D1h	PID1 feedback 3 input source selection	R/W	0 to 6, 8 to 13	1
AH-54	12754	31D2h	PID1 feedback calculation symbol selection	R/W	1 to 10	1
AH-60	12760	31D8h	PID1 gain change method selection	R/W	0 to 1	1
AH-61	12761	31D9h	PID1 proportional gain 1	R/W	0 to 1000	0.1
AH-62	12762	31Dah	PID1 integral time constant 1	R/W	0 to 36000	0.1s
AH-63	12763	31DBh	PID1 derivative gain 1	R/W	0 to 10000	0.01s
AH-64	12764	31DCh	PID1 proportional gain 2	R/W	0 to 1000	0.1
AH-65	12765	31DDh	PID1 integral time constant 2	R/W	0 to 36000	0.1s
AH-66	12766	31Deh	PID1 derivative gain 2	R/W	0 to 10000	0.01s
AH-67	12767	31DFh	PID1 gain change time	R/W	0 to 10000	1ms
AH-70	12770	31E2h	PID1 feed-forward input source selection	R/W	0 to 6	1
AH-71	12771	31E3h	PID1 output range	R/W	0 to 10000	0.01%
AH-72	12772	31E4h	PID1 over deviation level	R/W	0 to 10000	0.01%
AH-73	12773	31E5h	Turn-off level for the PID1 feedback compare signal	R/W	0 to 10000	0.01%
AH-74	12774	31E6h	Turn-on level for the PID1 feedback compare signal	R/W	0 to 10000	0.01%
AH-75	12775	31E7h	PID soft start function enable	R/W	0 to 1	1
AH-76	12776	31E8h	PID soft start target level	R/W	0 to 10000	0.01%
AH-78	12778	31Eah	Acceleration time setting for PID soft start function (High)	R/W	0 to 360000	0.01s
(AH-79)	12779	31Ebh	(Low)			
AH-80	12780	31Ech	PID soft start time	R/W	0 to 60000 *1)	0.01s
AH-81	12781	31Edh	PID soft start error detection enable	R/W	0 to 2	1
AH-82	12782	31Eeh	PID soft start error detection level	R/W	0 to 10000	0.01%
AH-85	12785	31F1h	PID sleep trigger selection	R/W	0 to 2	1
AH-86	12786	31F2h	PID sleep start level	R/W	0 to 59000	0.01Hz
AH-87	12787	31F3h	PID sleep active time	R/W	0 to 10000	0.01s
AH-88	12788	31F4h	Enable set-point boost before PID sleep	R/W	0 to 1	1
AH-89	12789	31F5h	Set-point boost time before PID sleep	R/W	0 to 10000	0.01s
AH-90	12790	31F6h	Set-point boost value before PID sleep	R/W	0 to 10000	0.01%
AH-91	12791	31F7h	Minimum RUN time before PID sleep	R/W	0 to 10000	0.01s
AH-92	12792	31F8h	Minimum active time of PID sleep	R/W	0 to 10000	0.01s
AH-93	12793	31F9h	PID wake trigger selection	R/W	1 to 3	1
AH-94	12794	31Fah	PID wake start level	R/W	0 to 10000	0.01%
AH-95	12795	31FBh	PID wake start time	R/W	0 to 10000	0.01s
AH-96	12796	31FCh	PID wake start deviation value	R/W	0 to 10000	0.01%
AJ-01	12801	3201h	PID2 enable	R/W	0 to 2	1
AJ-02	12802	3202h	PID2 deviation inversion	R/W	0 to 1	1
AJ-03	12803	3203h	PID2 unit selection	R/W	0 to 58	1
AJ-04	12804	3204h	PID2 scale adjustment (0%)	R/W	-10000 to 10000	1
AJ-05	12805	3205h	PID2 scale adjustment (100%)	R/W	-10000 to 10000	1
AJ-06	12806	3206h	PID2 scale adjustment (decimal point position)	R/W	0 to 4	1
AJ-07	12807	3207h	PID2 set-point input source selection	R/W	0 to 13, 15	1

*1) Setting range of Ver2.01 or older is 0 to 10000.

Function Code	Register No. (decimal)	Register No. (hexadecimal)	Function Name	R/W	Monitor Content and Setting Item	Data Resolution / Unit
AJ-10	12810	320Ah	PID2 set-point setting (High)	R/W	-10000 to 10000	Per AJ-06 setting
(AJ-11)	12811	320Bh	(Low)			
AJ-12	12812	320Ch	PID2 feedback input source selection	R/W	0 to 6, 8 to 13	1
AJ-13	12813	320Dh	PID2 proportional gain	R/W	0 to 1000	0.1
AJ-14	12814	320Eh	PID2 integral time constant	R/W	0 to 36000	0.1s
AJ-15	12815	320Fh	PID2 derivative gain	R/W	0 to 10000	0.01s
AJ-16	12816	3210h	PID2 output range	R/W	0 to 10000	0.01%
AJ-17	12817	3211h	PID2 over deviation level	R/W	0 to 10000	0.01%
AJ-18	12818	3212h	Turn-off level for the PID2 feedback compare signal	R/W	0 to 10000	0.01%
AJ-19	12819	3213h	Turn-on level for the PID2 feedback compare signal	R/W	0 to 10000	0.01%
AJ-21	12821	3215h	PID3 enable	R/W	0 to 2	1
AJ-22	12822	3216h	PID3 deviation inversion	R/W	0 to 1	1
AJ-23	12823	3217h	PID3 unit selection	R/W	0 to 58	1
AJ-24	12824	3218h	PID3 scale adjustment (0%)	R/W	-10000 to 10000	1
AJ-25	12825	3219h	PID3 scale adjustment (100%)	R/W	-10000 to 10000	1
AJ-26	12826	321Ah	PID3 scale adjustment (decimal point position)	R/W	0 to 4	1
AJ-27	12827	321Bh	PID3 set-point input source selection	R/W	0 to 13	1
AJ-30	12830	321Eh	PID3 set-point setting (High)	R/W	-10000 to 10000	Per AJ-26 setting
(AJ-31)	12831	321Fh	(Low)			
AJ-32	12832	3220h	PID3 feedback input source selection	R/W	0 to 6, 8 to 13	1
AJ-33	12833	3221h	PID3 proportional gain	R/W	0 to 1000	0.1
AJ-34	12834	3222h	PID3 integral time constant	R/W	0 to 36000	0.1s
AJ-35	12835	3223h	PID3 derivative gain	R/W	0 to 10000	0.01s
AJ-36	12836	3224h	PID3 output range	R/W	0 to 10000	0.01%
AJ-37	12837	3225h	PID3 over deviation level	R/W	0 to 10000	0.01%
AJ-38	12838	3226h	Turn-off level for the PID3 feedback compare signal	R/W	0 to 10000	0.01%
AJ-39	12839	3227h	Turn-on level for the PID3 feedback compare signal	R/W	0 to 10000	0.01%
AJ-41	12841	3229h	PID4 enable	R/W	0 to 2	1
AJ-42	12842	322Ah	PID4 deviation inversion	R/W	0 to 1	1
AJ-43	12843	322Bh	PID4 unit selection	R/W	0 to 58	1
AJ-44	12844	322Ch	PID4 scale adjustment (0%)	R/W	-10000 to 10000	1
AJ-45	12845	322Dh	PID4 scale adjustment (100%)	R/W	-10000 to 10000	1
AJ-46	12846	322Eh	PID4 scale adjustment (decimal point position)	R/W	0 to 4	1
AJ-47	12847	322Fh	PID4 set-point input source selection	R/W	0 to 13	1
AJ-50	12850	3232h	PID4 set-point setting (High)	R/W	-10000 to 10000	Per AJ-46 setting
(AJ-51)	12851	3233h	(Low)			
AJ-52	12852	3234h	PID4 feedback input source selection	R/W	0 to 6, 8 to 13	1
AJ-53	12853	3235h	PID4 proportional gain	R/W	0 to 1000	0.1
AJ-54	12854	3236h	PID4 integral time constant	R/W	0 to 36000	0.1s
AJ-55	12855	3237h	PID4 derivative gain	R/W	0 to 10000	0.01s
AJ-56	12856	3238h	PID4 output range	R/W	0 to 10000	0.01%
AJ-57	12857	3239h	PID4 over deviation level	R/W	0 to 10000	0.01%
AJ-58	12858	323Ah	Turn-off level for the PID4 feedback compare signal	R/W	0 to 10000	0.01%
AJ-59	12859	323Bh	Turn-on level for the PID4 feedback compare signal	R/W	0 to 10000	0.01%

Function Code	Register No. (decimal)	Register No. (hexadecimal)	Function Name	R/W	Monitor Content and Setting Item	Data Resolution / Unit
bA101	13001	32C9h	Upper frequency limit source selection, 1st-motor	R/W	0 to 13	1
bA102	13002	32Cah	Upper frequency limit, 1st-motor	R/W	0 to 59000	0.01Hz
bA103	13003	32CBh	Lower frequency limit, 1st-motor	R/W	0 to 59000	0.01Hz
bA110	13010	32D2h	Torque limit selection, 1st-motor	R/W	0 to 11	1
bA111	13011	32D3h	Torque limiting parameters mode selection, 1st-motor	R/W	0 to 1	1
bA112	13012	32D4h	Torque limit 1 (Forward drive), 1st-motor	R/W	0 to 5000	0.1%
bA113	13013	32D5h	Torque limit 2 (Reverse regenerative), 1st-motor	R/W	0 to 5000	0.1%
bA114	13014	32D6h	Torque limit 3 (Reverse drive), 1st-motor	R/W	0 to 5000	0.1%
bA115	13015	32D7h	Torque limit 4 (Forward regenerative), 1st-motor	R/W	0 to 5000	0.1%
bA116	13016	32D8h	Torque limit LADSTOP selection, 1st-motor	R/W	0 to 1	1
bA120	13020	32DCh	Overcurrent suppression enable, 1st-motor	R/W	0 to 1	1
bA121	13021	32DDh	Overcurrent suppression level, 1st-motor	R/W	(0 to 2.00)*rated current 0 to 20000 *1)	0.1A 0.01%
bA122	13022	32Deh	Overload restriction 1 mode selection, 1st-motor	R/W	0 to 3	1
bA123	13023	32DFh	Overload restriction 1 active level, 1st-motor	R/W	(0.2 to 2.0)*rated current 2000 to 20000 *1)	0.1A 0.01%
bA124	13024	32E0h	Overload restriction 1 action time, 1st-motor (High)	R/W	10 to 360000	0.01s
(bA125)	13025	32E1h	(Low)			
bA126	13026	32E2h	Overload restriction 2 mode selection, 1st-motor	R/W	0 to 3	1
bA127	13027	32E3h	Overload restriction 2 active level, 1st-motor	R/W	(0.2 to 2.0) * rated current 2000 to 20000 *1)	0.1A 0.01%
bA128	13028	32E4h	Overload restriction 2 action time, 1st-motor (High)	R/W	10 to 360000	0.01s
(bA129)	13029	32E5h	(Low)			
bA-30	13030	32E6h	Instantaneous power failure non-stop function, mode selection	R/W	0 to 3	1
bA-31	13031	32E7h	Instantaneous power failure non-stop function, start voltage level	R/W	200V class: 0 to 4100 400V class: 0 to 8200 0 to 20500 *1)	0.1VDC 0.01%
bA-32	13032	32E8h	Instantaneous power failure non-stop function, target voltage level	R/W	200V class: 0 to 4100 400V class: 0 to 8200 0 to 20500 *1)	0.1VDC 0.01%
bA-34	13034	32Eah	Instantaneous power failure non-stop function, deceleration time (High)	R/W	1 to 360000	0.01s
(bA-35)	13035	32Ebh	(Low)			
bA-36	13036	32Ech	Instantaneous power failure non-stop function, start frequency decrement	R/W	0 to 1000	0.01Hz
bA-37	13037	32Edh	Instantaneous power failure non-stop function, DC bus voltage control P gain	R/W	0 to 500	0.01
bA-38	13038	32Eeh	Instantaneous power failure non-stop function, DC bus voltage control I gain	R/W	0 to 15000	0.01s
bA140	13040	32F0h	Overvoltage suppression enable setting, 1st-motor	R/W	0 to 3	1
bA141	13041	32F1h	Overvoltage suppression active level, 1st-motor	R/W	200V class: 3300 to 4000 400V class: 6600 to 8000 16500 to 20000 *1)	0.1VDC 0.01%
bA142	13042	32F2h	Overvoltage suppression active time, 1st-motor (High)	R/W	0 to 360000	0.01s
(bA143)	13043	32F3h	(Low)			
bA144	13044	32F4h	Constant DC bus voltage control P gain, 1st-motor	R/W	0 to 500	0.01
bA145	13045	32F5h	Constant DC bus voltage control I gain, 1st-motor	R/W	0 to 15000	0.01s
bA146	13046	32F6h	Over-magnetization function selection, 1st-motor	R/W	0 to 4	1
bA147	13047	32F7h	Over-magnetization function output filter time constant, 1st-motor	R/W	0 to 100	0.01s
bA148	13048	32F8h	Over-magnetization function voltage gain, 1st-motor	R/W	50 to 400	1%
bA149	13049	32F9h	Over-magnetization function level setting, 1st-motor	R/W	200V class: 3300 to 4000 400V class: 6600 to 8000 16500 to 20000 *1)	0.1VDC 0.01%

*1) It is in case selected "%" at parameter [CF-11].

Function Code	Register No. (decimal)	Register No. (hexadecimal)	Function Name	R/W	Monitor Content and Setting Item	Data Resolution / Unit
bA-60	13060	3304h	Dynamic brake use ratio	R/W	0 - 1000 (linked with bA-63)	0.1%
bA-61	13061	3305h	Dynamic brake activation selection	R/W	0 to 2	1
bA-62	13062	3306h	Dynamic brake activation level	R/W	200V class: 3300 to 4000	0.1VDC
					400V class: 6600 to 8000 16500 to 20000 *1)	
bA-63	13063	3307h	Dynamic brake resistor value	R/W	From the minimum resistance to 600.0	0.1Ω
bA-70	13070	330Eh	Cooling fan control method selection	R/W	0 to 2	1
bA-71	13071	330Fh	Clear accumulated cooling fan run time monitor	R/W	0 to 1	1
bA201	23001	59D9h	Upper frequency limit source selection, 2nd-motor	R/W	0 to 13	1
bA202	23002	59Dah	Upper Frequency limit, 2nd-motor	R/W	0 to 59000	0.01Hz
bA203	23003	59DBh	Lower Frequency limit, 2nd-motor	R/W	0 to 59000	0.01Hz
bA210	23010	59E2h	Torque limit selection, 2nd-motor	R/W	0 to 11	1
bA211	23011	59E3h	Torque limiting parameters mode selection, 2nd-motor	R/W	0 to 1	1
bA212	23012	59E4h	Torque limit 1 (Forward drive), 2nd-motor	R/W	0 to 5000	0.1%
bA213	23013	59E5h	Torque limit 2 (Reverse regenerative), 2nd-motor	R/W	0 to 5000	0.1%
bA214	23014	59E6h	Torque limit 3 (Reverse drive), 2nd-motor	R/W	0 to 5000	0.1%
bA215	23015	59E7h	Torque limit 4 (Forward regenerative), 2nd-motor	R/W	0 to 5000	0.1%
bA216	23016	59E8h	Torque limit LADSTOP selection, 2nd-motor	R/W	0 to 1	1
bA220	23020	59Ech	Overcurrent suppression enable, 2nd-motor	R/W	0 to 1	1
bA221	23021	59Edh	Overcurrent suppression level, 2nd-motor	R/W	(0.0 to 2.0) * rated current	0.1A
					0 to 20000 *1)	0.01%
bA222	23022	59Eeh	Overload restriction 1 mode selection, 2nd-motor	R/W	0 to 3	1
bA223	23023	59Efh	Overload restriction 1 active level, 2nd-motor	R/W	(0.2 to 2.0) * rated current	0.1A
					2000 to 20000 *1)	0.01%
bA224	23024	59F0h	Overload restriction 1 action time, 2nd-motor (High)	R/W	10 to 360000	0.01s
(bA225)	23025	59F1h	(Low)			
bA226	23026	59F2h	Overload restriction 2 mode selection, 2nd-motor	R/W	0 to 3	1
bA227	23027	59F3h	Overload restriction 2 active level, 2nd-motor	R/W	(0.2 to 2.0) * rated current	0.1A
					2000 to 20000 *1)	0.01%
bA228	23028	59F4h	Overload restriction 2 action time, 2nd-motor (High)	R/W	10 to 360000	0.01s
(bA229)	23029	59F5h	(Low)			
bA240	23040	5A00h	Overvoltage suppression enable, 2nd-motor	R/W	0 to 3	1
bA241	23041	5A01h	Overvoltage suppression active level, 2nd-motor	R/W	200V class: 3300 to 4000	0.1VDC
					400V class: 6600 to 8000 16500 to 20000 *1)	
bA242	23042	5A02h	Overvoltage suppression active time, 2nd-motor (High)	R/W	0 to 360000	0.01s
(bA243)	23043	5A03h	(Low)			
bA244	23044	5A04h	Constant DC bus voltage control P gain, 2nd-motor	R/W	0 to 500	0.01
bA245	23045	5A05h	Constant DC bus voltage control I gain, 2nd-motor	R/W	0 to 15000	0.01s
bA246	23046	5A06h	Over magnetization function selection, 2nd-motor	R/W	0 to 4	1
bA247	23047	5A07h	Over magnetization function output filter time constant, 2nd-motor	R/W	0 to 100	0.01s
bA248	23048	5A08h	Over magnetization function voltage gain, 2nd-motor	R/W	50 to 400	1%
bA249	23049	5A09h	Over magnetization function level setting, 2nd-motor	R/W	200V class: 3300 to 4000	0.1VDC
					400V class: 6600 to 8000 16500 to 20000 *1)	

*1) It is in case selected "%" at parameter [CF-11].

Function Code	Register No. (decimal)	Register No. (hexadecimal)	Function Name	R/W	Monitor Content and Setting Item	Data Resolution / Unit
bb101	13101	332Dh	Carrier frequency setting, 1st-motor	R/W	5 to 160 (varies depending on selection of capacity and load rating)	0.1kHz
bb102	13102	332Eh	Sprinkle carrier pattern selection, 1st-motor	R/W	0 to 3	1
bb103	13103	332Fh	Automatic carrier reduction selection, 1st-motor	R/W	0 to 2	1
bb-10	13110	3336h	Automatic error reset selection	R/W	0 to 2	1
bb-11	13111	3337h	Alarm signal selection at automatic error reset	R/W	0 to 1	1
bb-12	13112	3338h	Automatic error reset wait time	R/W	0 to 600	1s
bb-13	13113	3339h	Automatic error reset number	R/W	0 to 10	1
bb-20	13120	3340h	Number of retries after instantaneous power failure	R/W	0 to 16 / 255	1
bb-21	13121	3341h	Number of retries after under voltage	R/W	0 to 16 / 255	1
bb-22	13122	3342h	Number of retries after overcurrent	R/W	0 to 5	1
bb-23	13123	3343h	Number of retries after over voltage	R/W	0 to 5	1
bb-24	13124	3344h	Restart mode selection after instantaneous power failure/under-voltage error	R/W	0 to 4	1
bb-25	13125	3345h	Instantaneous power failure allowed time	R/W	3 to 250	0.1s
bb-26	13126	3346h	Retry wait time after instantaneous power failure/under-voltage error	R/W	3 to 1000	0.1s
bb-27	13127	3347h	Enable instantaneous power failure/under-voltage trip while in stop status	R/W	0 to 2	1
bb-28	13128	3348h	Restart mode selection after an overcurrent error	R/W	0 to 4	1
bb-29	13129	3349h	Retry wait time after an overcurrent error	R/W	3 to 1000	0.1s
bb-30	13130	334Ah	Restart mode selection after an overvoltage error	R/W	0 to 4	1
bb-31	13131	334Bh	Retry wait time after an overvoltage error	R/W	3 to 1000	0.1s
bb-40	13140	3354h	Restart mode after FRS release	R/W	0 to 3	1
bb-41	13141	3355h	Restart mode after RS release	R/W	0 to 3	1
bb-42	13142	3356h	Frequency matching minimum restart frequency	R/W	0 to 59000	0.01Hz
bb-43	13143	3357h	Active frequency matching restart level	R/W	(0.2 to 2.0)*rated current 2000 to 20000 *1)	0.1A 0.01%
bb-44	13144	3358h	Active frequency matching restart constant (speed)	R/W	10 to 3000	0.01s
bb-45	13145	3359h	Active frequency matching restart constant (voltage)	R/W	10 to 3000	0.01s
bb-46	13146	335Ah	OC-suppress level at active frequency matching	R/W	(0.0 to 2.0) * rated current 0 to 20000 *1)	0.1A 0.01%
bb-47	13147	335Bh	Active frequency matching restart speed selection	R/W	0 to 2	1
bb-50 *2)	13150	335Eh	Frequency matching filter gain	R/W	0 to 1000	1%
bb160	13160	3368h	Overcurrent detection level, 1st-motor	R/W	(0.2 to 2.2) * ND rated current 2000 to 22000 *1)	0.1A 0.01%
bb-61	13161	3369h	Power supply overvoltage selection	R/W	0 to 1	1
bb-62	13162	336Ah	Power supply overvoltage level setting	R/W	200V class: 3000 to 4100 400V class: 6000 to 8200 15000 to 20500 *1)	0.1VDC 0.01%
bb-64	13164	336Ch	Detect ground fault selection	R/W	0 to 1	1
bb-65	13165	336Dh	Input phase loss detection enable	R/W	0 to 1	1
bb-66	13166	336Eh	Output phase loss detection enable	R/W	0 to 1	1
bb-67	13167	336Fh	Output phase loss detection sensitivity	R/W	1 to 100	1%
bb-70	13170	3372h	Thermistor error level	R/W	0 to 10000	1Ω
bb-80	13180	337Ch	Over-speed detection level	R/W	0 to 1500	0.1%
bb-81	13181	337Dh	Over-speed detection time	R/W	0 to 50	0.1s
bb-82	13182	337Eh	Speed deviation error mode selection	R/W	0 to 1	1
bb-83	13183	337Fh	Speed deviation error detection level	R/W	0 to 1000	0.1%
bb-84	13184	3380h	Speed deviation error detection time	R/W	0 to 50	0.1s
bb-85	13185	3381h	Position deviation error mode selection	R/W	0 to 1	1
bb-86	13186	3382h	Position deviation error detection level	R/W	0 to 65535 (*100pls)	1 (*100pls)
bb-87	13187	3383h	Position deviation error detection time	R/W	0 to 50	0.1s

*1) It is in case selected “%” at parameter [CF-11]. *2) [bb-50] is added to Ver2.03 or later.

Function Code	Register No. (decimal)	Register No. (hexadecimal)	Function Name	R/W	Monitor Content and Setting Item	Data Resolution / Unit
bb201	23101	5A3Dh	Carrier frequency setting, 2nd-motor	R/W	5 to 160 (varies depending on selection of capacity and load rating)	0.1kHz
bb202	23102	5A3Eh	Sprinkle carrier pattern selection, 2nd-motor	R/W	0 to 3	1
bb203	23103	5A3Fh	Automatic carrier reduction selection, 2nd-motor	R/W	0 to 2	1
bb260	23160	5A78h	Overcurrent detection level, 2nd-motor	R/W	(0.2 to 2.2) * ND rated current 2000 to 22000 *1)	0.1A 0.01%
bC110	13210	339Ah	Electronic thermal level setting, 1st-motor	R/W	(0.0 to 3.0)*rated current 0 to 30000 *1)	0.1A 0.01%
bC111	13211	339Bh	Electronic thermal characteristic selection, 1st-motor	R/W	0 to 2	1
bC112	13212	339Ch	Electronic thermal decrease function enable, 1st-motor	R/W	0 to 1	1
bC113	13213	339Dh	Electronic thermal decreasing time, 1st-motor	R/W	1 to 1000	1s
bC-14	13214	339Eh	Store electronic thermal counter at power-off	R/W	0 to 1	1
bC120	13220	33A4h	Free electronic thermal frequency-1, 1st-motor	R/W	0 to 59000 (bC122)	0.01Hz
bC121	13221	33A5h	Free electronic thermal current-1, 1st-motor	R/W	(0.0 to 3.0)*rated current 0 to 30000 *1)	0.1A 0.01%
bC122	13222	33A6h	Free electronic thermal frequency-2, 1st-motor	R/W	0 to 59000 (bC120 to bC124)	0.01Hz
bC123	13223	33A7h	Free electronic thermal current-2, 1st-motor	R/W	(0.0 to 3.0)*rated current 0 to 30000 *1)	0.1A 0.01%
bC124	13224	33A8h	Free electronic thermal frequency-3, 1st-motor	R/W	0 (bC122) to 59000	0.01Hz
bC125	13225	33A9h	Free electronic thermal current-3, 1st-motor	R/W	(0 to 3.0)*rated current 0 to 30000 *1)	0.1A 0.01%
bC210	23210	5AAAh	Electronic thermal level setting, 2nd-motor	R/W	(0 to 3.0)*rated current 0 to 30000 *1)	0.1A 0.01%
bC211	23211	5AABh	Electronic thermal characteristic selection, 2nd-motor	R/W	0 to 2	1
bC212	23212	5AACH	Electronic thermal decrease function selection, 2nd-motor	R/W	0 to 1	1
bC213	23213	5AADh	Electronic thermal decreasing time, 2nd-motor	R/W	1 to 1000	1s
bC220	23220	5AB4h	Free electronic thermal frequency-1, 2nd-motor	R/W	0 to 59000 (bC222)	0.01Hz
bC221	23221	5AB5h	Free electronic thermal current-1, 2nd-motor	R/W	(0.0 to 3.0)*rated current 0 to 30000 *1)	0.1A 0.01%
bC222	23222	5AB6h	Free electronic thermal frequency-2, 2nd-motor	R/W	0 to 59000 (bC220 to bC224)	0.01Hz
bC223	23223	5AB7h	Free electronic thermal current-2, 2nd-motor	R/W	(0.0 to 3.0)*rated current 0 to 30000 *1)	0.1A 0.01%
bC224	23224	5AB8h	Free electronic thermal frequency-3, 2nd-motor	R/W	0 (bC222) to 59000	0.01Hz
bC225	23225	5AB9h	Free electronic thermal current-3, 2nd-motor	R/W	(0.0 to 3.0)*rated current 0 to 30000 *1)	0.1A 0.01%
bd-01	13301	33F5h	STO input display selection	R/W	0 to 2	1
bd-02	13302	33F6h	STO input change time	R/W	0 to 6000	0.01s
bd-03	13303	33F7h	Display selection during STO input change time	R/W	0 to 1	1
bd-04	13304	33F8h	Action selection after STO input change time	R/W	0 to 2	1

*1) It is in case selected “%” at parameter [CF-11].

Function Code	Register No. (decimal)	Register No. (hexadecimal)	Function Name	R/W	Monitor Content and Setting Item	Data Resolution / Unit
CA-01	14001	36B1h	Input terminal [1] function	R/W	0 to 110	1
CA-02	14002	36B2h	Input terminal [2] function	R/W	0 to 110	1
CA-03	14003	36B3h	Input terminal [3] function	R/W	0 to 110	1
CA-04	14004	36B4h	Input terminal [4] function	R/W	0 to 110	1
CA-05	14005	36B5h	Input terminal [5] function	R/W	0 to 110	1
CA-06	14006	36B6h	Input terminal [6] function	R/W	0 to 110	1
CA-07	14007	36B7h	Input terminal [7] function	R/W	0 to 110	1
CA-08	14008	36B8h	Input terminal [8] function	R/W	0 to 110	1
CA-09	14009	36B9h	Input terminal [9] function	R/W	0 to 110	1
CA-10	14010	36Bah	Input terminal [A] function	R/W	0 to 110	1
CA-11	14011	36BBh	Input terminal [B] function	R/W	0 to 110	1
CA-21	14021	36C5h	Input terminal [1] active state	R/W	0 to 1	1
CA-22	14022	36C6h	Input terminal [2] active state	R/W	0 to 1	1
CA-23	14023	36C7h	Input terminal [3] active state	R/W	0 to 1	1
CA-24	14024	36C8h	Input terminal [4] active state	R/W	0 to 1	1
CA-25	14025	36C9h	Input terminal [5] active state	R/W	0 to 1	1
CA-26	14026	36Cah	Input terminal [6] active state	R/W	0 to 1	1
CA-27	14027	36CBh	Input terminal [7] active state	R/W	0 to 1	1
CA-28	14028	36CCh	Input terminal [8] active state	R/W	0 to 1	1
CA-29	14029	36CDh	Input terminal [9] active state	R/W	0 to 1	1
CA-30	14030	36Ceh	Input terminal [A] active state	R/W	0 to 1	1
CA-31	14031	36CFh	Input terminal [B] active state	R/W	0 to 1	1
CA-41	14041	36D9h	Input terminal [1] response time	R/W	0 to 400	1ms
CA-42	14042	36Dah	Input terminal [2] response time	R/W	0 to 400	1ms
CA-43	14043	36DBh	Input terminal [3] response time	R/W	0 to 400	1ms
CA-44	14044	36DCh	Input terminal [4] response time	R/W	0 to 400	1ms
CA-45	14045	36DDh	Input terminal [5] response time	R/W	0 to 400	1ms
CA-46	14046	36Deh	Input terminal [6] response time	R/W	0 to 400	1ms
CA-47	14047	36DFh	Input terminal [7] response time	R/W	0 to 400	1ms
CA-48	14048	36E0h	Input terminal [8] response time	R/W	0 to 400	1ms
CA-49	14049	36E1h	Input terminal [9] response time	R/W	0 to 400	1ms
CA-50	14050	36E2h	Input terminal [A] response time	R/W	0 to 400	1ms
CA-51	14051	36E3h	Input terminal [B] response time	R/W	0 to 400	1ms
CA-55	14055	36E7h	Multistage input determination time	R/W	0 to 2000	1ms
CA-60	14060	36Ech	FUP/FDN overwrite target selection	R/W	0 to 1	1
CA-61	14061	36Edh	FUP/FDN data save enable	R/W	0 to 1	1
CA-62	14062	36Eeh	FUP/FDN UDC selection	R/W	0 to 1	1
CA-64	14064	36F0h	Acceleration time setting for FUP/FDN function (High)	R/W	0 to 360000	0.01s
(CA-65)	14065	36F1h	(Low)			
CA-66	14066	36F2h	Deceleration time setting for FUP/FDN function (High)	R/W	0 to 360000	0.01s
(CA-67)	14067	36F3h	(Low)			
CA-70	14070	36F6h	Speed reference source selection when [F-OP] is active	R/W	1 to 16	1
CA-71	14071	36F7h	RUN command source selection when [F-OP] is active	R/W	0 to 6	1
CA-72	14072	36F8h	Reset mode selection	R/W	0 to 3	1

Function Code	Register No. (decimal)	Register No. (hexadecimal)	Function Name	R/W	Monitor Content and Setting Item	Data Resolution / Unit
CA-81	14081	3701h	Encoder constant setting (Internal)	R/W	32 to 65535	1pls
CA-82	14082	3702h	Encoder phase sequence selection (Internal)	R/W	0 to 1	1
CA-83	14083	3703h	Motor gear ratio numerator (Internal)	R/W	1 to 10000	1
CA-84	14084	3704h	Motor gear ratio denominator (Internal)	R/W	1 to 10000	1
CA-90	14090	370Ah	Pulse train input, target function selection (Internal)	R/W	0 to 3	1
CA-91	14091	370Bh	Pulse train input mode selection (Internal)	R/W	0 to 2	1
CA-92	14092	370Ch	Pulse train frequency scale (Internal)	R/W	5 to 3200	0.01kHz
CA-93	14093	370Dh	Pulse train frequency filter time constant (Internal)	R/W	1 to 200	0.01s
CA-94	14094	370Eh	Pulse train frequency bias value (Internal)	R/W	-1000 to 1000	0.1%
CA-95	14095	370Fh	Pulse train upper frequency detection level (Internal)	R/W	0 to 1000	0.1%
CA-96	14096	3710h	Pulse train lower frequency detection level (Internal)	R/W	0 to 1000	0.1%
CA-97	14097	3711h	Pulse counter compare match output ON value	R/W	0 to 65535	1
CA-98	14098	3712h	Pulse counter compare match output OFF value	R/W	0 to 65535	1
CA-99	14099	3713h	Pulse counter maximum value	R/W	0 to 65535	1
Cb-01	14101	3715h	[Ai1] Filter time constant	R/W	1 to 500	1ms
Cb-03	14103	3717h	[Ai1] Start value	R/W	0 to 10000	0.01%
Cb-04	14104	3718h	[Ai1] End value	R/W	0 to 10000	0.01%
Cb-05	14105	3719h	[Ai1] Start rate	R/W	0 to 1000 (Cb-06)	0.1%
Cb-06	14106	371Ah	[Ai1] End rate	R/W	(Cb-05) 0 to 1000	0.1%
Cb-07	14107	371Bh	[Ai1] Start value selection	R/W	0 to 1	1
Cb-11	14111	371Fh	[Ai2] Filter time constant	R/W	1 to 500	1ms
Cb-13	14113	3721h	[Ai2] Start value	R/W	0 to 10000	0.01%
Cb-14	14114	3722h	[Ai2] End value	R/W	0 to 10000	0.01%
Cb-15	14115	3723h	[Ai2] Start rate	R/W	0 to 1000 (Cb-16)	0.1%
Cb-16	14116	3724h	[Ai2] End rate	R/W	(Cb-15) to 1000	0.1%
Cb-17	14117	3725h	[Ai2] Start value selection	R/W	0 to 1	1
Cb-21	14121	3729h	[Ai3] Filter time constant	R/W	1 to 500	1ms
Cb-22	14122	372Ah	Terminal [Ai3] selection	R/W	0 to 2	1
Cb-23	14123	372Bh	[Ai3] Start value	R/W	-10000 to 10000	0.01%
Cb-24	14124	372Ch	[Ai3] End value	R/W	-10000 to 10000	0.01%
Cb-25	14125	372Dh	[Ai3] Start rate	R/W	-1000 to 1000 (Cb-26)	0.1%
Cb-26	14126	372Eh	[Ai3] End rate	R/W	(Cb-25)-1000 to 1000	0.1%
Cb-30	14130	3732h	[Ai1] Voltage/Current bias adjustment	R/W	-10000 to 10000	0.01%
Cb-31	14131	3733h	[Ai1] Voltage/Current gain adjustment	R/W	0 to 20000	0.01%
Cb-32	14132	3734h	[Ai2] Voltage/Current bias adjustment	R/W	-10000 to 10000	0.01%
Cb-33	14133	3735h	[Ai2] Voltage/Current gain adjustment	R/W	0 to 20000	0.01%
Cb-34	14134	3736h	[Ai3] Voltage bias adjustment	R/W	-10000 to 10000	0.01%
Cb-35	14135	3737h	[Ai3] Voltage gain adjustment	R/W	0 to 20000	0.01%
Cb-40	14140	373Ch	Thermistor type selection	R/W	0 to 2	1
Cb-41	14141	373Dh	Thermistor gain adjustment	R/W	0 to 10000	0.1
Cb-51	14151	3747h	MOP-VR input filter time constant	R/W	1 to 500	1ms
Cb-53	14153	3749h	MOP-VR start value	R/W	0 to 10000	0.01%
Cb-54	14154	374Ah	MOP-VR end value	R/W	0 to 10000	0.01%
Cb-55	14155	374Bh	MOP-VR start ratio	R/W	0 to 1000 (Cb-56)	0.1%
Cb-56	14156	374Ch	MOP-VR end ratio	R/W	(Cb-55) 0 to 1000	0.1%
Cb-57	14157	374Dh	MOP-VR start selection	R/W	0 to 1	1

Function Code	Register No. (decimal)	Register No. (hexadecimal)	Function Name	R/W	Monitor Content and Setting Item	Data Resolution / Unit
CC-01	14201	3779h	Output terminal [11] function	R/W	0 to 93	1
CC-02	14202	377Ah	Output terminal [12] function	R/W	0 to 93	1
CC-03	14203	377Bh	Output terminal [13] function	R/W	0 to 93	1
CC-04	14204	377Ch	Output terminal [14] function	R/W	0 to 93	1
CC-05	14205	377Dh	Output terminal [15] function	R/W	0 to 93	1
CC-06	14206	377Eh	Output terminal [16] function	R/W	0 to 93	1
CC-07	14207	377Fh	Output terminal [AL] function	R/W	0 to 93	1
CC-11	14211	3783h	Output terminal [11] active state	R/W	0 to 1	1
CC-12	14212	3784h	Output terminal [12] active state	R/W	0 to 1	1
CC-13	14213	3785h	Output terminal [13] active state	R/W	0 to 1	1
CC-14	14214	3786h	Output terminal [14] active state	R/W	0 to 1	1
CC-15	14215	3787h	Output terminal [15] active state	R/W	0 to 1	1
CC-16	14216	3788h	Output terminal [16] active state	R/W	0 to 1	1
CC-17	14217	3789h	Output terminal [AL] active state	R/W	0 to 1	1
CC-20	14220	378Ch	Output terminal [11] on-delay time	R/W	0 to 10000	0.01s
CC-21	14221	378Dh	Output terminal [11] off-delay time	R/W	0 to 10000	0.01s
CC-22	14222	378Eh	Output terminal [12] on-delay time	R/W	0 to 10000	0.01s
CC-23	14223	378Fh	Output terminal [12] off-delay time	R/W	0 to 10000	0.01s
CC-24	14224	3790h	Output terminal [13] on-delay time	R/W	0 to 10000	0.01s
CC-25	14225	3791h	Output terminal [13] off-delay time	R/W	0 to 10000	0.01s
CC-26	14226	3792h	Output terminal [14] on-delay time	R/W	0 to 10000	0.01s
CC-27	14227	3793h	Output terminal [14] off-delay time	R/W	0 to 10000	0.01s
CC-28	14228	3794h	Output terminal [15] on-delay time	R/W	0 to 10000	0.01s
CC-29	14229	3795h	Output terminal [15] off-delay time	R/W	0 to 10000	0.01s
CC-30	14230	3796h	Output terminal [16] on-delay time	R/W	0 to 10000	0.01s
CC-31	14231	3797h	Output terminal [16] off-delay time	R/W	0 to 10000	0.01s
CC-32	14232	3798h	Output terminal [AL] on-delay time	R/W	0 to 10000	0.01s
CC-33	14233	3799h	Output terminal [AL] off-delay time	R/W	0 to 10000	0.01s
CC-40	14240	37A0h	LOG1 operand-1 selection	R/W	0 to 93	1
CC-41	14241	37A1h	LOG1 operand-2 selection	R/W	0 to 93	1
CC-42	14242	37A2h	LOG1 logical calculation selection	R/W	0 to 2	1
CC-43	14243	37A3h	LOG2 operand-1 selection	R/W	0 to 93	1
CC-44	14244	37A4h	LOG2 operand-2 selection	R/W	0 to 93	1
CC-45	14245	37A5h	LOG2 logical calculation selection	R/W	0 to 2	1
CC-46	14246	37A6h	LOG3 operand-1 selection	R/W	0 to 93	1
CC-47	14247	37A7h	LOG3 operand-2 selection	R/W	0 to 93	1
CC-48	14248	37A8h	LOG3 logical calculation selection	R/W	0 to 2	1
CC-49	14249	37A9h	LOG4 operand-1 selection	R/W	0 to 93	1
CC-50	14250	37Aah	LOG4 operand-2 selection	R/W	0 to 93	1
CC-51	14251	37Abh	LOG4 logical calculation selection	R/W	0 to 2	1
CC-52	14252	37Ach	LOG5 operand-1 selection	R/W	0 to 93	1
CC-53	14253	37Adh	LOG5 operand-2 selection	R/W	0 to 93	1
CC-54	14254	37Aeh	LOG5 logical calculation selection	R/W	0 to 2	1
CC-55	14255	37Afh	LOG6 operand-1 selection	R/W	0 to 93	1
CC-56	14256	37B0h	LOG6 operand-2 selection	R/W	0 to 93	1
CC-57	14257	37B1h	LOG6 logical calculation selection	R/W	0 to 2	1

Function Code	Register No. (decimal)	Register No. (hexadecimal)	Function Name	R/W	Monitor Content and Setting Item	Data Resolution / Unit
CC-58	14258	37B2h	LOG7 operand-1 selection	R/W	0 to 93	1
CC-59	14259	37B3h	LOG7 operand-2 selection	R/W	0 to 93	1
CC-60	14260	37B4h	LOG7 logical calculation selection	R/W	0 to 2	1
Cd-01	14301	37DDh	[FM] Output wave form selection	R/W	0 to 1	1
Cd-02	14302	37Deh	[FM] Output base frequency (at frequency output)	R/W	0 to 3600	1Hz
Cd-03	14303	37DFh	[FM] Output monitor selection	R/W	0 to 65535 (register No. of d, F codes)	1
Cd-04	14304	37E0h	[Ao1] Output monitor selection	R/W	0 to 65535 (register No. of d, F codes)	1
Cd-05	14305	37E1h	[Ao2] Output monitor selection	R/W	0 to 65535 (register No. of d, F codes)	1
Cd-10	14310	37E6h	Analog monitor adjustment mode enable	R/W	0 to 1	1
Cd-11	14311	37E7h	[FM] Output filter time constant	R/W	1 to 500	1ms
Cd-12	14312	37E8h	[FM] Data type selection	R/W	0 to 1	1
Cd-13	14313	37E9h	[FM] Bias adjustment	R/W	-1000 to 1000	0.1%
Cd-14	14314	37Eah	[FM] Gain adjustment	R/W	-10000 to 10000	0.1%
Cd-15	14315	37Ebh	Adjustment mode [FM] output level	R/W	-1000 to 1000	0.1%
Cd-21	14321	37F1h	[Ao1] Output filter time constant	R/W	1 to 500	1ms
Cd-22	14322	37F2h	[Ao1] Data type selection	R/W	0 to 1	1
Cd-23	14323	37F3h	[Ao1] Bias adjustment	R/W	-1000 to 1000	0.1%
Cd-24	14324	37F4h	[Ao1] Gain adjustment	R/W	-10000 to 10000	0.1%
Cd-25	14325	37F5h	Adjustment mode [Ao1] output level	R/W	-1000 to 1000	0.1%
Cd-31	14331	37FBh	[Ao2] Output filter time constant	R/W	1 to 500	1ms
Cd-32	14332	37FCh	[Ao2] Data type selection	R/W	0 to 1	1
Cd-33	14333	37FDh	[Ao2] Bias adjustment	R/W	-1000 to 1000	0.1%
Cd-34	14334	37Feh	[Ao2] Gain adjustment	R/W	-10000 to 10000	0.1%
Cd-35	14335	37FFh	Adjustment mode [Ao2] output level	R/W	-1000 to 1000	0.1%
CE101	14401	3841h	Low current signal output mode selection, 1st motor	R/W	0 to 1	1
CE102	14402	3842h	Low current detection level 1, 1st motor	R/W	(0.0 to 2.0) * rated current 0 to 20000 *1)	0.1A 0.01%
CE103	14403	3843h	Low current detection level 2, 1st motor	R/W	(0.0 to 2.0) * rated current 0 to 20000 *1)	0.1A 0.01%
CE105	14405	3845h	Overload signal output mode selection, 1st motor	R/W	0 to 1	1
CE106	14406	3846h	Overload warning level 1, 1st motor	R/W	(0.0 to 2.0) * rated current 0 to 20000 *1)	0.1A 0.01%
CE107	14407	3847h	Overload warning level 2, 1st motor	R/W	(0.0 to 2.0) * rated current 0 to 20000 *1)	0.1A 0.01%
CE-10	14410	384Ah	Arrival frequency 1 value setting during acceleration	R/W	0 to 59000	0.01Hz
CE-11	14411	384Bh	Arrival frequency 1 value setting during deceleration	R/W	0 to 59000	0.01Hz
CE-12	14412	384Ch	Arrival frequency 2 value setting during acceleration	R/W	0 to 59000	0.01Hz
CE-13	14413	384Dh	Arrival frequency 2 value setting during deceleration	R/W	0 to 59000	0.01Hz
CE120	14420	3854h	Over-torque level (Forward drive), 1st motor	R/W	0 to 5000	0.1%
CE121	14421	3855h	Over-torque level (Reverse regenerative), 1st motor	R/W	0 to 5000	0.1%
CE122	14422	3856h	Over-torque level (Reverse drive), 1st motor	R/W	0 to 5000	0.1%
CE123	14423	3857h	Over-torque level (Forward regenerative), 1st motor	R/W	0 to 5000	0.1%

*1) It is in case selected "%" at parameter [CF-11].

Function Code	Register No. (decimal)	Register No. (hexadecimal)	Function Name	R/W	Monitor Content and Setting Item	Data Resolution / Unit
CE-30	14430	385Eh	Electronic thermal warning level (Motor)	R/W	0 to 10000	0.01%
CE-31	14431	385Fh	Electronic thermal warning level (Inverter)	R/W	0 to 10000	0.01%
CE-33	14433	3861h	Zero speed detection level	R/W	0 to 10000	0.01Hz
CE-34	14434	3862h	Cooling fin overheat warning level	R/W	0 to 200	1°C
CE-36	14436	3864h	Accum. RUN time (RNT) / Accum. Power-ON(ONT) time setting	R/W	0 to 100000	1hr
(CE-37)	14437	3865h	(Low)			
CE-40	14440	3868h	[Ai1] Window comparator higher limit	R/W	0 to 100	1%
CE-41	14441	3869h	[Ai1] Window comparator lower limit	R/W	0 to 100	1%
CE-42	14442	386Ah	[Ai1] Window comparator hysteresis width	R/W	0 to 10	1%
CE-43	14443	386Bh	[Ai2] Window comparator higher limit	R/W	0 to 100	1%
CE-44	14444	386Ch	[Ai2] Window comparator lower limit	R/W	0 to 100	1%
CE-45	14445	386Dh	[Ai2] Window comparator hysteresis width	R/W	0 to 10	1%
CE-46	14446	386Eh	[Ai3] Window comparator higher limit	R/W	-100 to 100	1%
CE-47	14447	386Fh	[Ai3] Window comparator lower limit	R/W	-100 to 100	1%
CE-48	14448	3870h	[Ai3] Window comparator hysteresis width	R/W	0 to 10	1%
CE-50	14450	3872h	[Ai1] Operation set level at disconnection or compare event	R/W	0 to 100	1%
CE-51	14451	3873h	[Ai1] Operation set level implement timing	R/W	0 to 2	1
CE-52	14452	3874h	[Ai2] Operation set level at disconnection or compare event	R/W	0 to 100	1%
CE-53	14453	3875h	[Ai2] Operation set level implement timing	R/W	0 to 2	1
CE-54	14454	3876h	[Ai3] Operation set level at disconnection or compare event	R/W	-100 to 100	1%
CE-55	14455	3877h	[Ai3] Operation set level implement timing	R/W	0 to 2	1
CE201	24401	5F51h	Low current signal output mode selection, 2nd-motor	R/W	0 to 1	1
CE202	24402	5F52h	Low current detection level 1, 2nd-motor	R/W	(0.0 to 2.0)*rated current	0.1A
					0 to 20000 *1)	0.01%
CE203	24403	5F53h	Low current detection level 2, 2nd-motor	R/W	(0.0 to 2.0)*rated current	0.1A
					0 to 20000 *1)	0.01%
CE205	24405	5F55h	Overcurrent signal output mode selection, 2nd-motor	R/W	0 to 1	1
CE206	24406	5F56h	Overcurrent detection level 1, 2nd-motor	R/W	(0.0 to 2.0)*rated current	0.1A
					0 to 20000 *1)	0.01%
CE207	24407	5F57h	Overcurrent detection level 2, 2nd-motor	R/W	(0.0 to 2.0)*rated current	0.1A
					0 to 20000 *1)	0.01%
CE220	24420	5F64h	Over-torque level (Forward drive), 2nd-motor	R/W	0 to 5000	0.1%
CE221	24421	5F65h	Over-torque level (Reverse regenerative), 2nd-motor	R/W	0 to 5000	0.1%
CE222	24422	5F66h	Over-torque level (Reverse drive), 2nd-motor	R/W	0 to 5000	0.1%
CE223	24423	5F67h	Over-torque level (Forward regenerative), 2nd motor	R/W	0 to 5000	0.1%

*1) It is in case selected "%" at parameter [CF-11].

Function Code	Register No. (decimal)	Register No. (hexadecimal)	Function Name	R/W	Monitor Content and Setting Item	Data Resolution / Unit
CF-01	14501	38A5h	RS485 communication baud rate selection	R/W	3 to 10	1
CF-02	14502	38A6h	RS485 communication node address	R/W	1 to 247	1
CF-03	14503	38A7h	RS485 communication parity selection	R/W	0 to 2	1
CF-04	14504	38A8h	RS485 communication stop bit selection	R/W	1 to 2	1
CF-05	14505	38A9h	RS485 communication error selection	R/W	0 to 4	1
CF-06	14506	38Aah	RS485 communication timeout setting	R/W	0 to 10000	0.01s
CF-07	14507	38Abh	RS485 communication wait time setting	R/W	0 to 1000	1ms
CF-08	14508	38Ach	RS485 communication mode selection	R/W	1 to 3	1
CF-11	14511	38AFh	Register data conversion function (A,V \leftrightarrow %)	R/W	0 to 1	1
CF-20	14520	38B8h	EzCOM start node No.	R/W	1 to 8	1
CF-21	14521	38B9h	EzCOM end node No.	R/W	1 to 8	1
CF-22	14522	38Bah	EzCOM start method selection	R/W	0 to 1	1
CF-23	14523	38BBh	EzCOM data size	R/W	1 to 5	1
CF-24	14524	38BCh	EzCOM destination address 1	R/W	1 to 247	1
CF-25	14525	38BDh	EzCOM destination register 1	R/W	0 to 65535	1
CF-26	14526	38Beh	EzCOM source register 1	R/W	0 to 65535	1
CF-27	14527	38BFh	EzCOM destination address 2	R/W	1 to 247	1
CF-28	14528	38C0h	EzCOM destination register 2	R/W	0 to 65535	1
CF-29	14529	38C1h	EzCOM source register 2	R/W	0 to 65535	1
CF-30	14530	38C2h	EzCOM destination address 3	R/W	1 to 247	1
CF-31	14531	38C3h	EzCOM destination register 3	R/W	0 to 65535	1
CF-32	14532	38C4h	EzCOM source register 3	R/W	0 to 65535	1
CF-33	14533	38C5h	EzCOM destination address 4	R/W	1 to 247	1
CF-34	14534	38C6h	EzCOM destination register 4	R/W	0 to 65535	1
CF-35	14535	38C7h	EzCOM source register 4	R/W	0 to 65535	1
CF-36	14536	38C8h	EzCOM destination address 5	R/W	1 to 247	1
CF-37	14537	38C9h	EzCOM destination register 5	R/W	0 to 65535	1
CF-38	14538	38Cah	EzCOM source register 5	R/W	0 to 65535	1
CF-50	14550	38D6h	USB communication node address	R/W	1 to 247	1

Function Code	Register No. (decimal)	Register No. (hexadecimal)	Function Name	R/W	Monitor Content and Setting Item	Data Resolution/ Unit
HA-01	15001	3A99h	Auto-tuning selection	R/W	0 to 3	1
HA-02	15002	3A9Ah	Auto-tuning RUN command source selection	R/W	0 to 1	1
HA-03	15003	3A9Bh	Online auto-tuning selection	R/W	0 to 1	1
HA110	15010	3AA2h	Stabilization constant, 1st-motor	R/W	0 to 1000	1%
HA112 *1)	15012	3AA4h	Stabilization ramp function end ratio, 1st-motor	R/W	0 to 100	1%
HA113 *1)	15013	3AA5h	Stabilization ramp function start ratio, 1st-motor	R/W	0 to 100	1%
HA115	15015	3AA7h	Speed response, 1st-motor	R/W	0 to 1000	1%
HA120	15020	3AACh	ASR gain switching mode selection, 1st-motor	R/W	0 to 1	1
HA121	15021	3AADh	ASR gain switching time setting, 1st-motor	R/W	0 to 10000	1ms
HA122	15022	3AAEh	ASR gain mapping intermediate speed 1, 1st-motor	R/W	0 to 59000	0.01Hz
HA123	15023	3AAFh	ASR gain mapping intermediate speed 2, 1st-motor	R/W	0 to 59000	0.01Hz
HA124	15024	3AB0h	ASR gain mapping maximum speed, 1st-motor	R/W	0 to 59000	0.01Hz
HA125	15025	3AB1h	ASR gain mapping P-gain 1, 1st-motor	R/W	0 to 10000	0.1%
HA126	15026	3AB2h	ASR gain mapping I-gain 1, 1st-motor	R/W	0 to 10000	0.1%
HA127	15027	3AB3h	ASR gain mapping P control P-gain 1, 1st-motor	R/W	0 to 10000	0.1%
HA128	15028	3AB4h	ASR gain mapping P-gain 2, 1st-motor	R/W	0 to 10000	0.1%
HA129	15029	3AB5h	ASR gain mapping I-gain 2, 1st-motor	R/W	0 to 10000	0.1%
HA130	15030	3AB6h	ASR gain mapping P control P-gain 2, 1st-motor	R/W	0 to 10000	0.1%
HA131	15031	3AB7h	ASR gain mapping P-gain 3, 1st-motor	R/W	0 to 10000	0.1%
HA132	15032	3AB8h	ASR gain mapping I-gain 3, 1st-motor	R/W	0 to 10000	0.1%
HA133	15033	3AB9h	ASR gain mapping P-gain 4, 1st-motor	R/W	0 to 10000	0.1%
HA134	15034	3ABAh	ASR gain mapping I-gain 4, 1st-motor	R/W	0 to 10000	0.1%
HA210	25010	61B2h	Stabilization constant, 2nd-motor	R/W	0 to 1000	1%
HA212 *1)	25012	61B4h	Stabilization ramp function end ratio, 1st-motor	R/W	0 to 100	1%
HA213 *1)	25013	61B5h	Stabilization ramp function start ratio, 1st-motor	R/W	0 to 100	1%
HA215	25015	61B7h	Speed response, 2nd-motor	R/W	0 to 1000	1%
HA220	25020	61BCh	ASR gain switching mode selection, 2nd-motor	R/W	0 to 1	1
HA221	25021	61BDh	ASR gain switching time setting, 2nd-motor	R/W	0 to 10000	1ms
HA222	25022	61Beh	ASR gain mapping intermediate speed 1, 2nd-motor	R/W	0 to 59000	0.01Hz
HA223	25023	61BFh	ASR gain mapping intermediate speed 2, 2nd-motor	R/W	0 to 59000	0.01Hz
HA224	25024	61C0h	ASR gain mapping maximum speed, 2nd-motor	R/W	0 to 59000	0.01Hz
HA225	25025	61C1h	ASR gain mapping P-gain 1, 2nd-motor	R/W	0 to 10000	0.1%
HA226	25026	61C2h	ASR gain mapping I-gain 1, 2nd-motor	R/W	0 to 10000	0.1%
HA227	25027	61C3h	ASR gain mapping P control P-gain 1, 2nd-motor	R/W	0 to 10000	0.1%
HA228	25028	61C4h	ASR gain mapping P-gain 2, 2nd-motor	R/W	0 to 10000	0.1%
HA229	25029	61C5h	ASR gain mapping I-gain 2, 2nd-motor	R/W	0 to 10000	0.1%
HA230	25030	61C6h	ASR gain mapping P control P-gain 2, 2nd-motor	R/W	0 to 10000	0.1%
HA231	25031	61C7h	ASR gain mapping P-gain 3, 2nd-motor	R/W	0 to 10000	0.1%
HA232	25032	61C8h	ASR gain mapping I-gain 3, 2nd-motor	R/W	0 to 10000	0.1%
HA233	25033	61C9h	ASR gain mapping P-gain 4, 2nd-motor	R/W	0 to 10000	0.1%
HA234	25034	61Cah	ASR gain mapping I-gain 4, 2nd-motor	R/W	0 to 10000	0.1%

*1) These are the parameters added to Ver2.03 or later.

Function Code	Register No. (decimal)	Register No. (hexadecimal)	Function Name	R/W	Monitor Content and Setting Item	Data Resolution / Unit
Hb102	15102	3AFEh	Async. Motor capacity setting, 1st-motor	R/W	1 to 16000 (132kW or lower) 1 to 50000 (160kW or Upper)	0.01kW 0.01kW
Hb103	15103	3AFFh	Async. Motor number of poles setting, 1st-motor	R/W	0 to 23	1
Hb104	15104	3B00h	Async. Motor base frequency setting, 1st-motor	R/W	1000 to 59000	0.01Hz
Hb105	15105	3B01h	Async. Motor maximum frequency setting, 1st-motor	R/W	1000 to 59000	0.01Hz
Hb106	15106	3B02h	Async. Motor rated voltage, 1st-motor	R/W	1 to 1000	1V
Hb108	15108	3B04h	Async. Motor rated current, 1st-motor (High)	R/W	1 to 1000000	0.01A
(Hb109)	15109	3B05h	(Low)			
Hb110	15110	3B06h	Async. Motor constant R1, 1st-motor (High)	R/W	1 to 1000000000	0.000001Ω
(Hb111)	15111	3B07h	(Low)			
Hb112	15112	3B08h	Async. Motor constant R2, 1st-motor (High)	R/W	1 to 1000000000	0.000001Ω
(Hb113)	15113	3B09h	(Low)			
Hb114	15114	3B0Ah	Async. Motor constant L, 1st-motor (High)	R/W	1 to 1000000000	0.000001mH
(Hb115)	15115	3B0Bh	(Low)			
Hb116	15116	3B0Ch	Async. Motor constant I0, 1st-motor (High)	R/W	1 to 1000000	0.01A
(Hb117)	15117	3B0Dh	(Low)			
Hb118	15118	3B0Eh	Async. Motor constant J, 1st-motor (High)	R/W	1 to 1000000000	0.00001kg·m ²
(Hb119)	15119	3B0Fh	(Low)			
Hb130	15130	3B1Ah	Minimum frequency adjustment, 1st-motor	R/W	10 to 1000	0.01Hz
Hb131	15131	3B1Bh	Reduced voltage start time setting, 1st-motor	R/W	0 to 2000	1ms
Hb140	15140	3B24h	Manual torque boost operation mode selection, 1st-motor	R/W	0 to 3	1
Hb141	15141	3B25h	Manual torque boost value, 1st-motor	R/W	0 to 200	0.1%
Hb142	15142	3B26h	Manual torque boost peak speed, 1st-motor	R/W	0 to 500	0.1%
Hb145	15145	3B29h	Eco drive enable, 1st-motor	R/W	0 to 1	1
Hb146	15146	3B2Ah	Eco drive response adjustment, 1st-motor	R/W	0 to 100	1
Hb150	15150	3B2Eh	Free-V/f frequency 1 setting, 1st-motor	R/W	0 to 59000 (Hb152)	0.01Hz
Hb151	15151	3B2Fh	Free-V/f voltage 1 setting, 1st-motor	R/W	0 to 10000	0.1V
Hb152	15152	3B30h	Free-V/f frequency 2 setting, 1st-motor	R/W	0 to 59000 (Hb150)to(Hb154)	0.01Hz
Hb153	15153	3B31h	Free-V/f voltage 2 setting, 1st-motor	R/W	0 to 10000	0.1V
Hb154	15154	3B32h	Free-V/f frequency 3 setting, 1st-motor	R/W	0 to 59000 (Hb152)to(Hb156)	0.01Hz
Hb155	15155	3B33h	Free-V/f voltage 3 setting, 1st-motor	R/W	0 to 10000	0.1V
Hb156	15156	3B34h	Free-V/f frequency 4 setting, 1st-motor	R/W	0 to 59000 (Hb154)to(Hb158)	0.01Hz
Hb157	15157	3B35h	Free-V/f voltage 4 setting, 1st-motor	R/W	0 to 10000	0.1V
Hb158	15158	3B36h	Free-V/f frequency 5 setting, 1st-motor	R/W	0 to 59000 (Hb156)to(Hb160)	0.01Hz
Hb159	15159	3B37h	Free-V/f voltage 5 setting, 1st-motor	R/W	0 to 10000	0.1V
Hb160	15160	3B38h	Free-V/f frequency 6 setting, 1st-motor	R/W	0 to 59000 (Hb158) to (Hb162)	0.01Hz
Hb161	15161	3B39h	Free-V/f voltage 6 setting, 1st-motor	R/W	0 to 10000	0.1V
Hb162	15162	3B3Ah	Free-V/f frequency 7 setting, 1st-motor	R/W	0 to 59000 (Hb160)to(Hb104)	0.01Hz
Hb163	15163	3B3Bh	Free-V/f voltage 7 setting, 1st-motor	R/W	0 to 10000	0.1V
Hb170	15170	3B42h	Slip compensation P-gain at V/f with encoder, 1st-motor	R/W	0 to 1000	1%
Hb171	15171	3B43h	Slip compensation I-gain at V/f with encoder, 1st-motor	R/W	0 to 1000	1%
Hb180	15180	3B4Ch	Output voltage gain, 1st-motor	R/W	0 to 255	1%

Function Code	Register No. (decimal)	Register No. (hexadecimal)	Function Name	R/W	Monitor Content and Setting Item	Data Resolution / Unit
Hb202	25102	620Eh	Async. Motor capacity setting, 2nd-motor	R/W	1 to 16000 (132kW or lower) 1 to 50000 (160kW or Upper)	0.01kW 0.01kW
Hb203	25103	620Fh	Async. Motor number of poles setting, 2nd-motor	R/W	0 to 23	1
Hb204	25104	6210h	Async. Motor base frequency setting, 2nd-motor	R/W	1000 to 59000	0.01Hz
Hb205	25105	6211h	Async. Motor maximum frequency setting, 2nd-motor	R/W	1000 to 59000	0.01Hz
Hb206	25106	6212h	Async. Motor rated voltage, 2nd-motor	R/W	1 to 1000	1V
Hb208	25108	6214h	Async. Motor rated current, 2nd-motor (High)	R/W	1 to 1000000	0.01A
(Hb209)	25109	6215h	(Low)			
Hb210	25110	6216h	Async. Motor constant R1, 2nd-motor (High)	R/W	1 to 1000000000	0.000001Ω
(Hb211)	25111	6217h	(Low)			
Hb212	25112	6218h	Async. Motor constant R2, 2nd-motor (High)	R/W	1 to 1000000000	0.000001Ω
(Hb213)	25113	6219h	(Low)			
Hb214	25114	621Ah	Async. Motor constant L, 2nd-motor (High)	R/W	1 to 1000000000	0.000001mH
(Hb215)	25115	621Bh	(Low)			
Hb216	25116	621Ch	Async. Motor constant I0, 2nd-motor (High)	R/W	1 to 1000000	0.01A
(Hb217)	25117	621Dh	(Low)			
Hb218	25118	621Eh	Async. Motor constant J, 2nd-motor (High)	R/W	1 to 1000000000	0.00001kg·m ²
(Hb219)	25119	621Fh	(Low)			
Hb230	25130	622Ah	Minimum frequency adjustment, 2nd-motor	R/W	10 to 1000	0.01Hz
Hb231	25131	622Bh	Reduced voltage start time setting, 2nd-motor	R/W	0 to 2000	1ms
Hb240	25140	6234h	Manual torque boost operation mode selection, 2nd-motor	R/W	0 to 3	1
Hb241	25141	6235h	Manual torque boost value, 2nd-motor	R/W	0 to 200	0.1%
Hb242	25142	6236h	Manual torque boost peak speed, 2nd-motor	R/W	0 to 500	0.1%
Hb245	25145	6239h	Eco drive enable, 2nd-motor	R/W	0 to 1	1
Hb246	25146	623Ah	Eco drive response adjustment, 2nd-motor	R/W	0 to 100	1
Hb250	25150	623Eh	Free-V/f frequency 1 setting, 2nd-motor	R/W	0 to 59000 (Hb252)	0.01Hz
Hb251	25151	623Fh	Free-V/f voltage 1 setting, 2nd-motor	R/W	0 to 10000	0.1V
Hb252	25152	6240h	Free-V/f frequency 2 setting, 2nd-motor	R/W	0 to 59000 (Hb250)to(Hb254)	0.01Hz
Hb253	25153	6241h	Free-V/f voltage 2 setting, 2nd-motor	R/W	0 to 10000	0.1V
Hb254	25154	6242h	Free-V/f frequency 3 setting, 2nd-motor	R/W	0 to 59000 (Hb252)to(Hb256)	0.01Hz
Hb255	25155	6243h	Free-V/f voltage 3 setting, 2nd-motor	R/W	0 to 10000	0.1V
Hb256	25156	6244h	Free-V/f frequency 4 setting, 2nd-motor	R/W	0 to 59000 (Hb254)to(Hb258)	0.01Hz
Hb257	25157	6245h	Free-V/f voltage 4 setting, 2nd-motor	R/W	0 to 10000	0.1V
Hb258	25158	6246h	Free-V/f frequency 5 setting, 2nd-motor	R/W	0 to 59000 (Hb256)to(Hb260)	0.01Hz
Hb259	25159	6247h	Free-V/f voltage 5 setting, 2nd-motor	R/W	0 to 10000	0.1V
Hb260	25160	6248h	Free-V/f frequency 6 setting, 2nd-motor	R/W	0 to 59000 (Hb258)to(Hb262)	0.01Hz
Hb261	25161	6249h	Free-V/f voltage 6 setting, 2nd-motor	R/W	0 to 10000	0.1V
Hb262	25162	624Ah	Free-V/f frequency 7 setting, 2nd-motor	R/W	0 to 59000 (Hb260)to(Hb204)	0.01Hz
Hb263	25163	624Bh	Free-V/f voltage 7 setting, 2nd-motor	R/W	0 to 10000	0.1V
Hb270	25170	6252h	Slip compensation P-gain at V/f with encoder, 2nd-motor	R/W	0 to 1000	1%
Hb271	25171	6253h	Slip compensation I-gain at V/f with encoder, 2nd-motor	R/W	0 to 1000	1%
Hb280	25180	625Ch	Output voltage gain, 2nd-motor	R/W	0 to 255	1%

Function Code	Register No. (decimal)	Register No. (hexadecimal)	Function Name	R/W	Monitor Content and Setting Item	Data Resolution / Unit
HC101	15201	3B61h	Automatic torque boost voltage compensation gain, 1st-motor	R/W	0 to 255	1%
HC102	15202	3B62h	Automatic torque boost slip compensation gain, 1st-motor	R/W	0 to 255	1%
HC110	15210	3B6Ah	Zero speed range limit, 1st-motor (IM-0Hz-SLV)	R/W	0 to 100	1%
HC111	15211	3B6Bh	Boost value at start, 1st-motor (IM-SLV,IM-CLV)	R/W	0 to 50	1%
HC112	15212	3B6Ch	Boost value at start, 1st-motor (IM-0Hz-SLV)	R/W	0 to 50	1%
HC113	15213	3B6Dh	Secondary resistance (R2) correction, 1st-motor	R/W	0 to 1	1
HC114	15214	3B6Eh	Direction reversal protection, 1st-motor	R/W	0 to 1	1
HC115	15215	3B6Fh	Torque conversion method selection, 1st-motor *1)	R/W	0 to 1	1
HC120	15220	3B74h	Torque current reference filter time constant, 1st-motor	R/W	0 to 100	1ms
HC121	15221	3B75h	Speed feedforward compensation gain, 1st-motor	R/W	0 to 1000	1%
HC137 *2)	15237	3B85h	Flux settling level, 1st-motor	R/W	0 to 1000	0.1%
HC140 *2)	15240	3B88h	Forcing level, 1st-motor	R/W	0 to 1000	1%
HC141 *2)	15241	3B89h	Modulation threshold 1, 1st-motor	R/W	0 to 133	1%
HC142 *2)	15242	3B8Ah	Modulation threshold 2, 1st-motor	R/W	0 to 133	1%
HC201	25201	6271h	Automatic torque boost voltage compensation gain, 2nd-motor	R/W	0 to 255	1%
HC202	25202	6272h	Automatic torque boost slip compensation gain, 2nd-motor	R/W	0 to 255	1%
HC210	25210	627Ah	Zero speed range limit, 2nd-motor (IM-0Hz-SLV)	R/W	0 to 100	1%
HC211	25211	627Bh	Boost value at start, 2nd-motor (IM-SLV,IM-CLV)	R/W	0 to 50	1%
HC212	25212	627Ch	Boost value at start, 2nd-motor (IM-0Hz-SLV)	R/W	0 to 50	1%
HC213	25213	627Dh	Secondary resistor (R2) compensation enable, 2nd-motor	R/W	0 to 1	1
HC214	25214	627Eh	Direction reversal protection, 2nd-motor	R/W	0 to 1	1
HC215 *1)	25215	627Fh	Torque conversion method selection, 2nd-motor	R/W	0 to 1	1
HC220	25220	6284h	Torque current reference filter time constant, 2nd-motor	R/W	0 to 100	1ms
HC221	25221	6285h	Speed feedforward compensation gain, 2nd-motor	R/W	0 to 1000	1%
HC237 *2)	25237	6295h	Flux settling level, 2nd-motor	R/W	0 to 1000	0.1%
HC240 *2)	25240	6298h	Forcing level, 2nd-motor	R/W	0 to 1000	1%
HC241 *2)	25241	6299h	Modulation threshold 1, 2nd-motor	R/W	0 to 133	1%
HC242 *2)	25242	629Ah	Modulation threshold 2, 2nd-motor	R/W	0 to 133	1%

*1) [HC115] / [HC215] is a parameter added in Ver2.02 or later.

*2) These are the parameters added to Ver2.03 or later.

Function Code	Register No. (decimal)	Register No. (hexadecimal)	Function Name	R/W	Monitor Content and Setting Item	Data Resolution / Unit
Hd102	15302	3BC6h	Sync. Motor capacity setting, 1st-motor	R/W	1 to 16000 (132kW or lower) 1 to 50000 (160kW or Upper)	0.01kW 0.01kW
Hd103	15303	3BC7h	Sync. Motor number of poles setting, 1st-motor	R/W	0 to 23	1
Hd104	15304	3BC8h	Sync. Motor Base frequency setting, 1st-motor	R/W	1000 to 59000	0.01Hz
Hd105	15305	3BC9h	Sync. Motor Maximum frequency setting, 1st-motor	R/W	1000 to 59000	0.01Hz
Hd106	15306	3BCAh	Sync. Motor rated voltage, 1st-motor	R/W	1 to 1000	1V
Hd108	15308	3BCCh	Sync. Motor rated current, 1st-motor (High)	R/W	1 to 1000000	0.01A
(Hd109)	15309	3BCDh	(Low)			
Hd110	15310	3BCEh	Sync. Motor constant R, 1st-motor (High)	R/W	1 to 1000000000	0.000001Ω
(Hd111)	15311	3BCFh	(Low)			
Hd112	15312	3BD0h	Sync. Motor constant Ld, 1st-motor (High)	R/W	1 to 1000000000	0.000001mH
(Hd113)	15313	3BD1h	(Low)			
Hd114	15314	3BD2h	Sync. Motor constant Lq, 1st-motor (High)	R/W	1 to 1000000000	0.000001mH
(Hd115)	15315	3BD3h	(Low)			
Hd116	15316	3BD4h	Sync. Motor constant Ke, 1st-motor (High)	R/W	1 to 1000000	0.1mVs/rad
(Hd117)	15317	3BD5h	(Low)			
Hd118	15318	3BD6h	Sync. Motor constant J, 1st-motor (High)	R/W	1 to 1000000000	0.00001 kg·m ²
(Hd119)	15319	3BD7h	(Low)			
Hd130	15330	3BE2h	Minimum frequency adjustment for Sync.M, 1st-motor	R/W	0 to 50	1%
Hd131	15331	3BE3h	No-Load current for Sync.M, 1st-motor	R/W	0 to 100	1%
Hd132	15332	3BE4h	Starting method for Sync.M, 1st-motor	R/W	0 to 1	1
Hd133	15333	3BE5h	IMPE 0V wait number for Sync.M, 1st-motor	R/W	0 to 255	1
Hd134	15334	3BE6h	IMPE detect wait number for Sync.M, 1st-motor	R/W	0 to 255	1
Hd135	15335	3BE7h	IMPE detect number for Sync.M, 1st-motor	R/W	0 to 255	1
Hd136	15336	3BE8h	IMPE voltage gain for Sync.M, 1st-motor	R/W	0 to 200	1%
Hd137	15337	3BE9h	IMPE Mg-pole position offset, 1st-motor	R/W	0 to 359	1deg
Hd-41	15341	3BEDh	IVMS carrier frequency	R/W	5 to 160	0.1kHz
Hd-42	15342	3BEEh	Filter gain of IVMS current detection	R/W	0 to 1000	1
Hd-43	15343	3BEFh	Open-phase voltage detection gain	R/W	0 to 3	1
Hd-44	15344	3BF0h	Open-phase switching threshold compensation	R/W	0 to 1	1
Hd-45	15345	3BF1h	SM(PMM)-IVMS speed control P gain	R/W	0 to 1000	1
Hd-46	15346	3BF2h	SM(PMM)-IVMS speed control I gain	R/W	0 to 10000	1
Hd-47	15347	3BF3h	SM(PMM)-IVMS wait time for open-phase switching,	R/W	0 to 1000	1
Hd-48	15348	3BF4h	SM(PMM)-IVMS restriction on the rotation-direction determination	R/W	0 to 1	1
Hd-49	15349	3BF5h	SM(PMM)-IVMS open-phase voltage detection timing adjustment,	R/W	0 to 1000	1
Hd-50	15350	3BF6h	SM(PMM)-IVMS minimum pulse width adjustment,	R/W	0 to 1000	1
Hd-51	15351	3BF7h	IVMS threshold current limit	R/W	0 to 255	1
Hd-52	15352	3BF8h	IVMS threshold gain	R/W	0 to 255	1
Hd-58	15358	3BFEh	IVMS carrier-frequency switching start/finish point	R/W	0 to 50	1%

Function Code	Register No. (decimal)	Register No. (hexadecimal)	Function Name	R/W	Monitor Content and Setting Item	Data Resolution / Unit
Hd202	25302	62D6h	Sync. Motor capacity setting, 2nd-motor	R/W	1 to 16000 (132kW or lower) 1 to 50000 (160kW or Upper)	0.01kW 0.01kW
Hd203	25303	62D7h	Sync. Motor number of poles setting, 2nd-motor	R/W	0 to 23	1
Hd204	25304	62D8h	Sync. Motor Base frequency setting, 2nd-motor	R/W	1000 to 59000	0.01Hz
Hd205	25305	62D9h	Sync. Motor Maximum frequency setting, 2nd-motor	R/W	1000 to 59000	0.01Hz
Hd206	25306	62Dah	Sync. Motor rated voltage, 2nd-motor	R/W	1 to 1000	1V
Hd208	25308	62DCh	Sync. Motor rated current, 2nd-motor (High)	R/W	1 to 1000000	0.01A
(Hd209)	25309	62DDh	(Low)			
Hd210	25310	62Deh	Sync. Motor constant R, 2nd-motor (High)	R/W	1 to 1000000000	0.000001Ω
(Hd211)	25311	62DFh	(Low)			
Hd212	25312	62E0h	Sync. Motor constant Ld, 2nd-motor (High)	R/W	1 to 1000000000	0.000001mH
(Hd213)	25313	62E1h	(Low)			
Hd214	25314	62E2h	Sync. Motor constant Lq, 2nd-motor (High)	R/W	1 to 1000000000	0.000001mH
(Hd215)	25315	62E3h	(Low)			
Hd216	25316	62E4h	Sync. Motor constant Ke, 2nd-motor (High)	R/W	1 to 1000000	0.1mVs/rad
(Hd217)	25317	62E5h	(Low)			
Hd218	25318	62E6h	Sync. Motor constant J, 2nd-motor (High)	R/W	1 to 1000000000	0.00001 kg·m ²
(Hd219)	25319	62E7h	(Low)			
Hd230	25330	62F2h	Minimum frequency adjustment for Sync.M, 2nd-motor	R/W	0 to 50	1%
Hd231	25331	62F3h	No-Load current for Sync.M, 2nd-motor	R/W	0 to 100	1%
Hd232	25332	62F4h	Starting method for Sync.M, 2nd-motor	R/W	0 to 1	1
Hd233	25333	62F5h	IMPE 0V wait number for Sync.M, 2nd-motor	R/W	0 to 255	1
Hd234	25334	62F6h	IMPE detect wait number for Sync.M, 2nd-motor	R/W	0 to 255	1
Hd235	25335	62F7h	IMPE detect number for Sync.M, 2nd-motor	R/W	0 to 255	1
Hd236	25336	62F8h	IMPE voltage gain for Sync.M, 2nd-motor	R/W	0 to 200	1%
Hd237	25337	62F9h	IMPE Mg-pole position offset, 2nd-motor	R/W	0 to 359	1deg

Function Code	Register No. (decimal)	Register No. (hexadecimal)	Function Name	R/W	Monitor Content and Setting Item	Data Resolution / Unit
oA-10	16010	3E8Ah	Operation selection at an option error (SLOT-1)	R/W	0 to 1	1
oA-11	16011	3E8Bh	Communication Watch Dog Timer (SLOT-1)	R/W	0 to 10000	0.01s
oA-12	16012	3E8Ch	Action selection at a communication error (SLOT-1)	R/W	0 to 4	1
oA-13	16013	3E8Dh	RUN command selection at start up (SLOT-1)	R/W	0 to 1	1
oA-20	16020	3E94h	Operation selection at an option error (SLOT-2)	R/W	0 to 1	1
oA-21	16021	3E95h	Communication Watch Dog Timer (SLOT-2)	R/W	0 to 10000	0.01s
oA-22	16022	3E96h	Action selection at a communication error (SLOT-2)	R/W	0 to 4	1
oA-23	16023	3E97h	RUN command selection at start up (SLOT-2)	R/W	0 to 1	1
oA-30	16030	3E9Eh	Operation selection at an option error (SLOT-3)	R/W	0 to 1	1
oA-31	16031	3E9Fh	Communication Watch Dog Timer (SLOT-3)	R/W	0 to 10000	0.01s
oA-32	16032	3EA0h	Action selection at a communication error (SLOT-3)	R/W	0 to 4	1
oA-33	16033	3EA1h	RUN command selection at start up (SLOT-3)	R/W	0 to 1	1
ob-01	16101	3EE5h	Encoder constant setting (option)	R/W	32 to 65535	1pls
ob-02	16102	3EE6h	Encoder phase sequence selection (option)	R/W	0 to 1	1
ob-03	16103	3EE7h	Motor gear ratio numerator (option)	R/W	1 to 10000	1
ob-04	16104	3EE8h	Motor gear ratio denominator (option)	R/W	1 to 10000	1
ob-10	16110	3EEEh	Pulse train input, target function selection (option)	R/W	0 to 1	1
ob-11	16111	3EEFh	Pulse train input mode selection (option)	R/W	0 to 2	1
ob-12	16112	3EF0h	Pulse train frequency scale (option)	R/W	5 to 20000	0.01kHz
ob-13	16113	3EF1h	Pulse train frequency filter time constant (option)	R/W	1 to 200	0.01s
ob-14	16114	3EF2h	Pulse train frequency bias value (option)	R/W	-1000 to 1000	0.1%
ob-15	16115	3EF3h	Pulse train upper frequency detection level(option)	R/W	0 to 1000	0.1%
ob-16	16116	3EF4h	Pulse train lower frequency detection level (option)	R/W	0 to 1000	0.1%
oC-01	16201	3F49h	Safety option input display selection	R/W	0 to 1	1
oC-10	16210	3F52h	SS1-A deceleration time setting (High)	R/W	0 to 360000	0.01s
oC-11	16211	3F53h	(Low)			
oC-12	16212	3F54h	SLS-A deceleration time setting (High)	R/W	0 to 360000	0.01s
oC-13	16213	3F55h	(Low)			
oC-14	16214	3F56h	SLS-A speed upper limit (Forward)	R/W	0 to 59000	0.01Hz
oC-15	16215	3F57h	SLS-A speed upper limit (Reverse)	R/W	0 to 59000	0.01Hz
oC-16	16216	3F58h	SDI-A deceleration time setting (High)	R/W	0 to 360000	0.01s
oC-17	16217	3F59h	(Low)			
oC-18	16218	3F5Ah	SDI-A direction limit mode	R/W	0 to 1	1
oC-20	16220	3F5Ch	SS1-B deceleration time setting (High)	R/W	0 to 360000	0.01s
oC-21	16221	3F5Dh	(Low)			
oC-22	16222	3F5Eh	SLS-B deceleration time setting (High)	R/W	0 to 360000	0.01s
oC-23	16223	3F5Fh	(Low)			
oC-24	16224	3F60h	SLS-B speed upper limit (Forward)	R/W	0 to 59000	0.01Hz
oC-25	16225	3F61h	SLS-B speed upper limit (Reverse)	R/W	0 to 59000	0.01Hz
oC-26	16226	3F62h	SDI-B deceleration time setting (High)	R/W	0 to 360000	0.01s
oC-27	16227	3F63h	(Low)			
oC-28	16228	3F64h	SDI-B direction limit mode	R/W	0 to 1	1

Function Code	Register No. (decimal)	Register No. (hexadecimal)	Function Name	R/W	Monitor Content and Setting Item	Data Resolution / Unit
oE-01	16401	4011h	[Ai4] Filter time constant	R/W	1 to 500	1ms
oE-03	16403	4013h	[Ai4] Start value	R/W	0 to 10000	0.01%
oE-04	16404	4014h	[Ai4] End value	R/W	0 to 10000	0.01%
oE-05	16405	4015h	[Ai4] Start rate	R/W	0 to 1000 (oE-06)	0.1%
oE-06	16406	4016h	[Ai4] End rate	R/W	(oE-05) 0 to 1000	0.1%
oE-07	16407	4017h	[Ai4] Start point selection	R/W	0 to 1	1
oE-11	16411	401Bh	[Ai5] Filter time constant	R/W	1 to 500	1ms
oE-13	16413	401Dh	[Ai5] Start value	R/W	0 to 10000	0.01%
oE-14	16414	401Eh	[Ai5] End value	R/W	0 to 10000	0.01%
oE-15	16415	401Fh	[Ai5] Start rate	R/W	0 to 1000 (oE-16)	0.1%
oE-16	16416	4020h	[Ai5] End rate	R/W	(oE-15) 0 to 1000	0.1%
oE-17	16417	4021h	[Ai5] Start point selection	R/W	0 to 1	1
oE-21	16421	4025h	[Ai6] Filter time constant	R/W	1 to 500	1ms
oE-23	16423	4027h	[Ai6] Start value	R/W	-10000 to 10000	0.01%
oE-24	16424	4028h	[Ai6] End value	R/W	-10000 to 10000	0.01%
oE-25	16425	4029h	[Ai6] Start rate	R/W	-1000 to 1000 (oE-26)	0.1%
oE-26	16426	402Ah	[Ai6] End rate	R/W	(oE-25) -1000 to 1000	0.1%
oE-28	16428	402Ch	[Ai4] Voltage/Current bias adjustment	R/W	-10000 to 10000	0.01%
oE-29	16429	402Dh	[Ai4] Voltage/Current gain adjustment	R/W	0 to 20000	0.01%
oE-30	16430	402Eh	[Ai5] Voltage/Current bias adjustment	R/W	-10000 to 10000	0.01%
oE-31	16431	402Fh	[Ai5] Voltage/Current gain adjustment	R/W	0 to 20000	0.01%
oE-32	16432	4030h	[Ai6] Voltage bias adjustment	R/W	-10000 to 10000	0.01%
oE-33	16433	4031h	[Ai6] Voltage gain adjustment	R/W	0 to 20000	0.01%
oE-35	16435	4033h	[Ai4] Window comparator upper limit	R/W	0 to 100	1%
oE-36	16436	4034h	[Ai4] Window comparator lower limit	R/W	0 to 100	1%
oE-37	16437	4035h	[Ai4] Window comparator hysteresis width	R/W	0 to 10	1%
oE-38	16438	4036h	[Ai5] Window comparator upper limit	R/W	0 to 100	1%
oE-39	16439	4037h	[Ai5] Window comparator lower limit	R/W	0 to 100	1%
oE-40	16440	4038h	[Ai5] Window comparator hysteresis width	R/W	0 to 10	1%
oE-41	16441	4039h	[Ai6] Window comparator upper limit	R/W	-100 to 100	1%
oE-42	16442	403Ah	[Ai6] Window comparator lower limit	R/W	-100 to 100	1%
oE-43	16443	403Bh	[Ai6] Window comparator hysteresis width	R/W	0 to 10	1%
oE-44	16444	403Ch	[Ai4] Temporal operation level set at disconnection or compare event	R/W	0 to 100	1%
oE-45	16445	403Dh	[Ai4] Temporal operation level implementation timing	R/W	0 to 2	1
oE-46	16446	403Eh	[Ai5] Temporal operation level set at disconnection or compare event	R/W	0 to 100	1%
oE-47	16447	403Fh	[Ai5] Temporal operation level implementation timing	R/W	0 to 2	1
oE-48	16448	4040h	[Ai6] Temporal operation level set at disconnection or compare event	R/W	-100 to 100	1%
oE-49	16449	4041h	[Ai6] Temporal operation level implementation timing	R/W	0 to 2	1

Function Code	Register No. (decimal)	Register No. (hexadecimal)	Function Name	R/W	Monitor Content and Setting Item	Data Resolution / Unit
oE-50	16450	4042h	[Ao3] Output monitor selection	R/W	0 to 65535 (register No.)	1
oE-51	16451	4043h	[Ao4] Output monitor selection	R/W	0 to 65535 (register No.)	1
oE-52	16452	4044h	[Ao5] Output monitor selection	R/W	0 to 65535 (register No.)	1
oE-56	16456	4048h	[Ao3] Output filter time constant	R/W	1 to 500	1ms
oE-57	16457	4049h	[Ao3] Data type selection	R/W	0 to 1	1
oE-58	16458	404Ah	[Ao3] Bias adjustment	R/W	-1000 to 1000	0.1%
oE-59	16459	404Bh	[Ao3] Gain adjustment	R/W	-10000 to 10000	0.1%
oE-60	16460	404Ch	Adjustment mode [Ao3] output level	R/W	-1000 to 1000	0.1%
oE-61	16461	404Dh	[Ao4] Output filter time constant	R/W	1 to 500	1ms
oE-62	16462	404Eh	[Ao4] Data type selection	R/W	0 to 1	1
oE-63	16463	404Fh	[Ao4] Bias adjustment	R/W	-1000 to 1000	0.1%
oE-64	16464	4050h	[Ao4] Gain adjustment	R/W	-10000 to 10000	0.1%
oE-65	16465	4051h	Adjustment mode [Ao4] output level	R/W	-1000 to 1000	0.1%
oE-66	16466	4052h	[Ao5] Output filter time constant	R/W	1 to 500	1ms
oE-67	16467	4053h	[Ao5] Data type selection	R/W	0 to 1	1
oE-68	16468	4054h	[Ao5] Bias adjustment	R/W	-1000 to 1000	0.1%
oE-69	16469	4055h	[Ao5] Gain adjustment	R/W	-10000 to 10000	0.1%
oE-70	16470	4056h	Adjustment mode [Ao5] output level	R/W	-1000 to 1000	0.1%
oH-01	16701	413Dh	IP-address selection	R/W	0 to 1	1
oH-02	16702	413Eh	Communication speed (port-1)	R/W	0 to 4	1
oH-03	16703	413Fh	Communication speed (port-2)	R/W	0 to 4	1
oH-04	16704	4140h	Ethernet communication timeout	R/W	1 to 65535	1 (*10ms)
oH-05	16705	4141h	Modbus TCP Port No.(IPv4)	R/W	502,1024 to 65535	1
oH-06	16706	4142h	Modbus TCP Port No.(IPv6)	R/W	502,1024 to 65535	1
oH-20	16720	4150h	PROFIBUS Node address	R/W	0 to 125	1
oH-21	16721	4151h	Profibus Clear Mode selection	R/W	For factory setting. Do not change.	1
oH-22	16722	4152h	Profibus Map selection	R/W		1
oH-23	16723	4153h	Profibus master setting selection	R/W		1
oH-24	16724	4154h	PROFIBUS Telegram group selection	R/W		0 to 2
oH-30	16730	415Ah	PN IP-Address select	R/W	For factory setting. Do not change.	1
oH-31	16731	415Bh	PN Communication speed (port-1)	R/W		1
oH-32	16732	415Ch	PN Communication speed (port-2)	R/W		1
oH-33	16733	415Dh	PN Ethernet communication timeout)	R/W		1 (*10ms)
oH-34	16734	415Eh	PROFINET Telegram group selection	R/W	0 to 2	1
oH-40	16740	4164h	DeviceNet node address (MAC ID)	R/W	0 to 63	1
oH-41	16741	4165h	DeviceNet assembly instance number selection	R/W	0 to 7	1
oH-42	16742	4166h	DeviceNet speed unit selection	R/W	0 to 1	1
oH-44	16744	4168h	DeviceNet flexible Gr. Format selection	R/W	0 to 2	1
oH-45	16745	4169h	DeviceNet idle mode action selection	R/W	0 to 4	1

Function Code	Register No. (decimal)	Register No. (hexadecimal)	Function Name	R/W	Monitor Content and Setting Item	Data Resolution / Unit
oJ-01	16801	41A1h	Writing register 1, Gr.A	R/W	0 to 65535	1
oJ-02	16802	41A2h	Writing register 2, Gr.A	R/W	0 to 65535	1
oJ-03	16803	41A3h	Writing register 3, Gr.A	R/W	0 to 65535	1
oJ-04	16804	41A4h	Writing register 4, Gr.A	R/W	0 to 65535	1
oJ-05	16805	41A5h	Writing register 5, Gr.A	R/W	0 to 65535	1
oJ-06	16806	41A6h	Writing register 6, Gr.A	R/W	0 to 65535	1
oJ-07	16807	41A7h	Writing register 7, Gr.A	R/W	0 to 65535	1
oJ-08	16808	41A8h	Writing register 8, Gr.A	R/W	0 to 65535	1
oJ-09	16809	41A9h	Writing register 9, Gr.A	R/W	0 to 65535	1
oJ-10	16810	41AAh	Writing register 10, Gr.A	R/W	0 to 65535	1
oJ-11	16811	41ABh	Reading register 1 Gr.A	R/W	0 to 65535	1
oJ-12	16812	41ACh	Reading register 2 Gr.A	R/W	0 to 65535	1
oJ-13	16813	41ADh	Reading register 3 Gr.A	R/W	0 to 65535	1
oJ-14	16814	41AEh	Reading register 4 Gr.A	R/W	0 to 65535	1
oJ-15	16815	41AFh	Reading register 5 Gr.A	R/W	0 to 65535	1
oJ-16	16816	41B0h	Reading register 6 Gr.A	R/W	0 to 65535	1
oJ-17	16817	41B1h	Reading register 7 Gr.A	R/W	0 to 65535	1
oJ-18	16818	41B2h	Reading register 8 Gr.A	R/W	0 to 65535	1
oJ-19	16819	41B3h	Reading register 9 Gr.A	R/W	0 to 65535	1
oJ-20	16820	41B4h	Reading register 10 Gr.A	R/W	0 to 65535	1
oJ-21	16821	41B5h	Writing register 1, Gr.B	R/W	0 to 65535	1
oJ-22	16822	41B6h	Writing register 2, Gr.B	R/W	0 to 65535	1
oJ-23	16823	41B7h	Writing register 3, Gr.B	R/W	0 to 65535	1
oJ-24	16824	41B8h	Writing register 4, Gr.B	R/W	0 to 65535	1
oJ-25	16825	41B9h	Writing register 5, Gr.B	R/W	0 to 65535	1
oJ-26	16826	41BAh	Writing register 6, Gr.B	R/W	0 to 65535	1
oJ-27	16827	41BBh	Writing register 7, Gr.B	R/W	0 to 65535	1
oJ-28	16828	41BCh	Writing register 8, Gr.B	R/W	0 to 65535	1
oJ-29	16829	41BDh	Writing register 9, Gr.B	R/W	0 to 65535	1
oJ-30	16830	41BEh	Writing register 10, Gr.B	R/W	0 to 65535	1
oJ-31	16831	41BFh	Reading register 1 Gr.B	R/W	0 to 65535	1
oJ-32	16832	41C0h	Reading register 2 Gr.B	R/W	0 to 65535	1
oJ-33	16833	41C1h	Reading register 3 Gr.B	R/W	0 to 65535	1
oJ-34	16834	41C2h	Reading register 4 Gr.B	R/W	0 to 65535	1
oJ-35	16835	41C3h	Reading register 5 Gr.B	R/W	0 to 65535	1
oJ-36	16836	41C4h	Reading register 6 Gr.B	R/W	0 to 65535	1
oJ-37	16837	41C5h	Reading register 7 Gr.B	R/W	0 to 65535	1
oJ-38	16838	41C6h	Reading register 8 Gr.B	R/W	0 to 65535	1
oJ-39	16839	41C7h	Reading register 9 Gr.B	R/W	0 to 65535	1
oJ-40	16840	41C8h	Reading register 10 Gr.B	R/W	0 to 65535	1

Function Code	Register No. (decimal)	Register No. (hexadecimal)	Function Name	R/W	Monitor Content and Setting Item	Data Resolution / Unit
oJ-41	16841	41C9h	Writing register 1, Gr.C	R/W	0 to 65535	1
oJ-42	16842	41CAh	Writing register 2, Gr.C	R/W	0 to 65535	1
oJ-43	16843	41CBh	Writing register 3, Gr.C	R/W	0 to 65535	1
oJ-44	16844	41CCh	Writing register 4, Gr.C	R/W	0 to 65535	1
oJ-45	16845	41CDh	Writing register 5, Gr.C	R/W	0 to 65535	1
oJ-46	16846	41CEh	Writing register 6, Gr.C	R/W	0 to 65535	1
oJ-47	16847	41CFh	Writing register 7, Gr.C	R/W	0 to 65535	1
oJ-48	16848	41D0h	Writing register 8, Gr.C	R/W	0 to 65535	1
oJ-49	16849	41D1h	Writing register 9, Gr.C	R/W	0 to 65535	1
oJ-50	16850	41D2h	Writing register 10, Gr.C	R/W	0 to 65535	1
oJ-51	16851	41D3h	Reading register 1 Gr.C	R/W	0 to 65535	1
oJ-52	16852	41D4h	Reading register 2 Gr.C	R/W	0 to 65535	1
oJ-53	16853	41D5h	Reading register 3 Gr.C	R/W	0 to 65535	1
oJ-54	16854	41D6h	Reading register 4 Gr.C	R/W	0 to 65535	1
oJ-55	16855	41D7h	Reading register 5 Gr.C	R/W	0 to 65535	1
oJ-56	16856	41D8h	Reading register 6 Gr.C	R/W	0 to 65535	1
oJ-57	16857	41D9h	Reading register 7 Gr.C	R/W	0 to 65535	1
oJ-58	16858	41DAh	Reading register 8 Gr.C	R/W	0 to 65535	1
oJ-59	16859	41DBh	Reading register 9 Gr.C	R/W	0 to 65535	1
oJ-60	16860	41DCh	Reading register 10 Gr.C	R/W	0 to 65535	1
oL-01	16901	4205h	IPv4 IP address (1) Gr.1	R/W	0 to 255	1
oL-02	16902	4206h	IPv4 IP address (2) Gr.1	R/W	0 to 255	1
oL-03	16903	4207h	IPv4 IP address (3) Gr.1	R/W	0 to 255	1
oL-04	16904	4208h	IPv4 IP address (4) Gr.1	R/W	0 to 255	1
oL-05	16905	4209h	IPv4 subnet mask (1) Gr.1	R/W	0 to 255	1
oL-06	16906	420Ah	IPv4 subnet mask (2) Gr.1	R/W	0 to 255	1
oL-07	16907	420Bh	IPv4 subnet mask (3) Gr.1	R/W	0 to 255	1
oL-08	16908	420Ch	IPv4 subnet mask (4) Gr.1	R/W	0 to 255	1
oL-09	16909	420Dh	IPv4 default gateway (1) Gr.1	R/W	0 to 255	1
oL-10	16910	420Eh	IPv4 default gateway (2) Gr.1	R/W	0 to 255	1
oL-11	16911	420Fh	IPv4 default gateway (3) Gr.1	R/W	0 to 255	1
oL-12	16912	4210h	IPv4 default gateway (4) Gr.1	R/W	0 to 255	1
oL-20	16920	4218h	IPv6 IP address (1) Gr.1	R/W	0 to 65535	1
oL-21	16921	4219h	IPv6 IP address (2) Gr.1	R/W	0 to 65535	1
oL-22	16922	421Ah	IPv6 IP address (3) Gr.1	R/W	0 to 65535	1
oL-23	16923	421Bh	IPv6 IP address (4) Gr.1	R/W	0 to 65535	1
oL-24	16924	421Ch	IPv6 IP address (5) Gr.1	R/W	0 to 65535	1
oL-25	16925	421Dh	IPv6 IP address (6) Gr.1	R/W	0 to 65535	1
oL-26	16926	421Eh	IPv6 IP address (7) Gr.1	R/W	0 to 65535	1
oL-27	16927	421Fh	IPv6 IP address (8) Gr.1	R/W	0 to 65535	1
oL-28	16928	4220h	IPv6 Prefix of subnet, Gr.1	R/W	0 to 127	1

Function Code	Register No. (decimal)	Register No. (hexadecimal)	Function Name	R/W	Monitor Content and Setting Item	Data Resolution / Unit
oL-29	16929	4221h	IPv6 default gateway (1) Gr.1	R/W	0 to 65535	1
oL-30	16930	4222h	IPv6 default gateway (2) Gr.1	R/W	0 to 65535	1
oL-31	16931	4223h	IPv6 default gateway (3) Gr.1	R/W	0 to 65535	1
oL-32	16932	4224h	IPv6 default gateway (4) Gr.1	R/W	0 to 65535	1
oL-33	16933	4225h	IPv6 default gateway (5) Gr.1	R/W	0 to 65535	1
oL-34	16934	4226h	IPv6 default gateway (6) Gr.1	R/W	0 to 65535	1
oL-35	16935	4227h	IPv6 default gateway (7) Gr.1	R/W	0 to 65535	1
oL-36	16936	4228h	IPv6 default gateway (8) Gr.1	R/W	0 to 65535	1
oL-40	16940	422Ch	IPv4 IP-address (1) Gr.2	R/W	0 to 255	1
oL-41	16941	422Dh	IPv4 IP-address (2) Gr.2	R/W	0 to 255	1
oL-42	16942	422Eh	IPv4 IP-address (3) Gr.2	R/W	0 to 255	1
oL-43	16943	422Fh	IPv4 IP-address (4) Gr.2	R/W	0 to 255	1
oL-44	16944	4230h	IPv4 subnet mask (1) Gr.2	R/W	0 to 255	1
oL-45	16945	4231h	IPv4 subnet mask (2) Gr.2	R/W	0 to 255	1
oL-46	16946	4232h	IPv4 subnet mask (3) Gr.2	R/W	0 to 255	1
oL-47	16947	4233h	IPv4 subnet mask (4) Gr.2	R/W	0 to 255	1
oL-48	16948	4234h	IPv4 default gateway (1) Gr.2	R/W	0 to 255	1
oL-49	16949	4235h	IPv4 default gateway (2) Gr.2	R/W	0 to 255	1
oL-50	16950	4236h	IPv4 default gateway (3) Gr.2	R/W	0 to 255	1
oL-51	16951	4237h	IPv4 default gateway (4) Gr.2	R/W	0 to 255	1
oL-60	16960	4240h	IPv6 IP address (1) Gr.2	R/W	0 to 65535	1
oL-61	16961	4241h	IPv6 IP address (2) Gr.2	R/W	0 to 65535	1
oL-62	16962	4242h	IPv6 IP address (3) Gr.2	R/W	0 to 65535	1
oL-63	16963	4243h	IPv6 IP address (4) Gr.2	R/W	0 to 65535	1
oL-64	16964	4244h	IPv6 IP address (5) Gr.2	R/W	0 to 65535	1
oL-65	16965	4245h	IPv6 IP address (6) Gr.2	R/W	0 to 65535	1
oL-66	16966	4246h	IPv6 IP address (7) Gr.2	R/W	0 to 65535	1
oL-67	16967	4247h	IPv6 IP address (8) Gr.2	R/W	0 to 65535	1
oL-68	16968	4248h	IPv6 Prefix of subnet, Gr.2	R/W	0 to 127	1
oL-69	16969	4249h	IPv6 default gateway (1) Gr.2	R/W	0 to 65535	1
oL-70	16970	424Ah	IPv6 default gateway (2) Gr.2	R/W	0 to 65535	1
oL-71	16971	424Bh	IPv6 default gateway (3) Gr.2	R/W	0 to 65535	1
oL-72	16972	424Ch	IPv6 default gateway (4) Gr.2	R/W	0 to 65535	1
oL-73	16973	424Dh	IPv6 default gateway (5) Gr.2	R/W	0 to 65535	1
oL-74	16974	424Eh	IPv6 default gateway (6) Gr.2	R/W	0 to 65535	1
oL-75	16975	424Fh	IPv6 default gateway (7) Gr.2	R/W	0 to 65535	1
oL-76	16976	4250h	IPv6 default gateway (8) Gr.2	R/W	0 to 65535	1

Function Code	Register No. (decimal)	Register No. (hexadecimal)	Function Name	R/W	Monitor Content and Setting Item	Data Resolution / Unit
PA-01	17001	4269h	Enable Emergency-force drive mode	R/W	0 to 1	1
PA-02	17002	426Ah	Emergency-force drive frequency reference	R/W	0 to 59000	0.01Hz
PA-03	17003	426Bh	Emergency-force drive direction command	R/W	0 to 1	1
PA-04	17004	426Ch	Commercial power supply bypass function selection	R/W	0 to 1	1
PA-05	17005	426Dh	Commercial power supply bypass function delay time	R/W	0 to 10000	0.1s
PA-20	17020	427Ch	Simulation mode enable	R/W	0 to 1	1
PA-21	17021	427Dh	Error code selection for alarm test	R/W	0 to 255	1
PA-22	17022	427Eh	Simulation mode: Optional output selection for the output current monitor	R/W	0 to 7	1
PA-23	17023	427Fh	Optional output value setting for the output current monitor	R/W	(0.0 to 3.0) * rated current	0.1A
					0 to 30000 *1)	0.01%
PA-24	17024	4280h	Simulation mode: Optional output selection for the DC bus voltage monitor	R/W	0 to 7	1
PA-25	17025	4281h	Optional output value setting for the DC bus voltage monitor	R/W	200Vclass:0 to 4500	0.1VDC
					400Vclass:0 to 9000	0.01%
					0 to 22500 *1)	
PA-26	17026	4282h	Simulation mode: Optional output selection for the output voltage monitor	R/W	0 to 7	1
PA-27	17027	4283h	Optional output value setting for the output voltage monitor	R/W	200Vclass:0 to 3000	0.1V
					400Vclass:0 to 6000	0.01%
					0 to 15000 *1)	
PA-28	17028	4284h	Simulation mode: Optional output selection for the output torque monitor	R/W	0 to 7	1
PA-29	17029	4285h	Optional output value setting for the output torque monitor	R/W	-5000 to 5000	0.1%
PA-30	17030	4286h	Simulation mode: Optional frequency matching start enable setting	R/W	0 to 7	1
PA-31	17031	4287h	Optional frequency matching start setting value	R/W	0 to 59000	0.01Hz

*1) It is in case selected "%" at parameter [CF-11].

Function Code	Register No. (decimal)	Register No. (hexadecimal)	Function Name	R/W	Monitor Content and Setting Item	Data Resolution / Unit
UA-10	18010	465Ah	Display restriction selection	R/W	0 to 4	1
UA-12	18012	465Ch	Accumulated input power monitor clear	R/W	0 to 1	1
UA-13	18013	465Dh	Display gain for the accumulated input power monitor	R/W	1 to 1000	1
UA-14	18014	465Eh	Accumulated output power monitor clear	R/W	0 to 1	1
UA-15	18015	465Fh	Display gain for the accumulated output power monitor	R/W	1 to 1000	1
UA-16	18016	4660h	Soft-Lock selection	R/W	0 to 1	1
UA-17	18017	4661h	Soft-Lock target selection	R/W	0 to 1	1
UA-18	18018	4662h	Data R/W selection	R/W	0 to 1	1
UA-19	18019	4663h	Low battery warning enable	R/W	0 to 2	1
UA-20	18020	4664h	Action selection at keypad disconnection	R/W	0 to 4	1
UA-21	18021	4665h	2nd-motor parameter display selection	R/W	0 to 1	1
UA-22	18022	4666h	Option parameter display selection	R/W	0 to 1	1
UA-30	18030	466Eh	User-parameter auto setting function enable	R/W	0 to 1	1
UA-31	18031	466Fh	User-parameter 1 selection	R/W	0 to 65535 (register No.)	1
UA-32	18032	4670h	User-parameter 2 selection	R/W	0 to 65535 (register No.)	1
UA-33	18033	4671h	User-parameter 3 selection	R/W	0 to 65535 (register No.)	1
UA-34	18034	4672h	User-parameter 4 selection	R/W	0 to 65535 (register No.)	1
UA-35	18035	4673h	User-parameter 5 selection	R/W	0 to 65535 (register No.)	1
UA-36	18036	4674h	User-parameter 6 selection	R/W	0 to 65535 (register No.)	1
UA-37	18037	4675h	User-parameter 7 selection	R/W	0 to 65535 (register No.)	1
UA-38	18038	4676h	User-parameter 8 selection	R/W	0 to 65535 (register No.)	1
UA-39	18039	4677h	User-parameter 9 selection	R/W	0 to 65535 (register No.)	1
UA-40	18040	4678h	User-parameter 10 selection	R/W	0 to 65535 (register No.)	1
UA-41	18041	4679h	User-parameter 11 selection	R/W	0 to 65535 (register No.)	1
UA-42	18042	467Ah	User-parameter 12 selection	R/W	0 to 65535 (register No.)	1
UA-43	18043	467Bh	User-parameter 13 selection	R/W	0 to 65535 (register No.)	1
UA-44	18044	467Ch	User-parameter 14 selection	R/W	0 to 65535 (register No.)	1
UA-45	18045	467Dh	User-parameter 15 selection	R/W	0 to 65535 (register No.)	1
UA-46	18046	467Eh	User-parameter 16 selection	R/W	0 to 65535 (register No.)	1
UA-47	18047	467Fh	User-parameter 17 selection	R/W	0 to 65535 (register No.)	1
UA-48	18048	4680h	User-parameter 18 selection	R/W	0 to 65535 (register No.)	1
UA-49	18049	4681h	User-parameter 19 selection	R/W	0 to 65535 (register No.)	1
UA-50	18050	4682h	User-parameter 20 selection	R/W	0 to 65535 (register No.)	1
UA-51	18051	4683h	User-parameter 21 selection	R/W	0 to 65535 (register No.)	1
UA-52	18052	4684h	User-parameter 22 selection	R/W	0 to 65535 (register No.)	1
UA-53	18053	4685h	User-parameter 23 selection	R/W	0 to 65535 (register No.)	1
UA-54	18054	4686h	User-parameter 24 selection	R/W	0 to 65535 (register No.)	1
UA-55	18055	4687h	User-parameter 25 selection	R/W	0 to 65535 (register No.)	1
UA-56	18056	4688h	User-parameter 26 selection	R/W	0 to 65535 (register No.)	1
UA-57	18057	4689h	User-parameter 27 selection	R/W	0 to 65535 (register No.)	1
UA-58	18058	468Ah	User-parameter 28 selection	R/W	0 to 65535 (register No.)	1
UA-59	18059	468Bh	User-parameter 29 selection	R/W	0 to 65535 (register No.)	1
UA-60	18060	468Ch	User-parameter 30 selection	R/W	0 to 65535 (register No.)	1
UA-61	18061	468Dh	User-parameter 31 selection	R/W	0 to 65535 (register No.)	1
UA-62	18062	468Eh	User-parameter 32 selection	R/W	0 to 65535 (register No.)	1

Function Code	Register No. (decimal)	Register No. (hexadecimal)	Function Name	R/W	Monitor Content and Setting Item	Data Resolution / Unit
UA-90	18090	46AAh	Waiting time for turning off the display(MOP)	R/W	0 to 60	1min
UA-91	18091	46ABh	Initial display selection (MOP)	R/W	0 to 65535 (register No. of d, F codes)	1
UA-92	18092	46ACh	Enable auto-return to the initial display (MOP)	R/W	0 to 1	1
UA-93	18093	46ADh	Enable frequency changes through monitor display(MOP)	R/W	0 to 1	1
UA-94	18094	46AEh	Enable multispeed frequency changes through monitor display (MOP)	R/W	0 to 1	1
Ub-01	18101	46B5h	Initialize mode selection	R/W	0 to 8	1
Ub-02	18102	46B6h	Initialize data selection	R/W	0 to 3	1
Ub-03	18103	46B7h	Load type selection	R/W	0 to 2	1
Ub-05	18105	46B9h	Enable initialization	R/W	0 to 1	1
UC-01	18201	4719h	(-)	R/W	For factory setting. Do not change.	1
Ud-01	18301	477Dh	Trace function enable	R/W	0 to 1	1
Ud-02	18302	477Eh	Trace start	R/W	0 to 1	1
Ud-03	18303	477Fh	Number of trace data setting	R/W	0 to 8	1
Ud-04	18304	4780h	Number of trace signals setting	R/W	0 to 8	1
Ud-10	18310	4786h	Trace data 0 selection	R/W	0 to 65535 (register No. of d, F codes)	1
Ud-11	18311	4787h	Trace data 1 selection	R/W	0 to 65535 (register No. of d, F codes)	1
Ud-12	18312	4788h	Trace data 2 selection	R/W	0 to 65535 (register No. of d, F codes)	1
Ud-13	18313	4789h	Trace data 3 selection	R/W	0 to 65535 (register No. of d, F codes)	1
Ud-14	18314	478Ah	Trace data 4 selection	R/W	0 to 65535 (register No. of d, F codes)	1
Ud-15	18315	478Bh	Trace data 5 selection	R/W	0 to 65535 (register No. of d, F codes)	1
Ud-16	18316	478Ch	Trace data 6 selection	R/W	0 to 65535 (register No. of d, F codes)	1
Ud-17	18317	478Dh	Trace data 7 selection	R/W	0 to 65535 (register No. of d, F codes)	1
Ud-20	18320	4790h	Trace signal 0 input/output selection	R/W	0 to 1	1
Ud-21	18321	4791h	Trace signal 0 input terminal selection	R/W	0 to 110	1
Ud-22	18322	4792h	Trace signal 0 output terminal selection	R/W	0 to 93	1
Ud-23	18323	4793h	Trace signal 1 input/output selection	R/W	0 to 1	1
Ud-24	18324	4794h	Trace signal 1 input terminal selection	R/W	0 to 110	1
Ud-25	18325	4795h	Trace signal 1 output terminal selection	R/W	0 to 93	1
Ud-26	18326	4796h	Trace signal 2 input/output selection	R/W	0 to 1	1
Ud-27	18327	4797h	Trace signal 2 input terminal selection	R/W	0 to 110	1
Ud-28	18328	4798h	Trace signal 2 output terminal selection	R/W	0 to 93	1
Ud-29	18329	4799h	Trace signal 3 input/output selection	R/W	0 to 1	1
Ud-30	18330	479Ah	Trace signal 3 input terminal selection	R/W	0 to 110	1
Ud-31	18331	479Bh	Trace signal 3 output terminal selection	R/W	0 to 93	1
Ud-32	18332	479Ch	Trace signal 4 input/output selection	R/W	0 to 1	1
Ud-33	18333	479Dh	Trace signal 4 input terminal selection	R/W	0 to 110	1
Ud-34	18334	479Eh	Trace signal 4 output terminal selection	R/W	0 to 93	1
Ud-35	18335	479Fh	Trace signal 5 input/output selection	R/W	0 to 1	1
Ud-36	18336	47A0h	Trace signal 5 input terminal selection	R/W	0 to 110	1
Ud-37	18337	47A1h	Trace signal 5 output terminal selection	R/W	0 to 93	1

Function Code	Register No. (decimal)	Register No. (hexadecimal)	Function Name	R/W	Monitor Content and Setting Item	Data Resolution / Unit
Ud-38	18338	47A2h	Trace signal 6 input/output selection	R/W	0 to 1	1
Ud-39	18339	47A3h	Trace signal 6 input terminal selection	R/W	0 to 110	1
Ud-40	18340	47A4h	Trace signal 6 output terminal selection	R/W	0 to 93	1
Ud-41	18341	47A5h	Trace signal 7 input/output selection	R/W	0 to 1	1
Ud-42	18342	47A6h	Trace signal 7 input terminal selection	R/W	0 to 110	1
Ud-43	18343	47A7h	Trace signal 7 output terminal selection	R/W	0 to 93	1
Ud-50	18350	47AEh	Trace trigger 1 selection	R/W	0 to 16	1
Ud-51	18351	47AFh	Trigger 1 activation selection at trace data trigger	R/W	0 to 1	1
Ud-52	18352	47B0h	Trigger 1 level setting at trace data trigger	R/W	0 to 100	1%
Ud-53	18353	47B1h	Trigger 1 activation selection at trace signal trigger	R/W	0 to 1	1
Ud-54	18354	47B2h	Trace trigger 2 selection	R/W	0 to 16	1
Ud-55	18355	47B3h	Trigger 2 activation selection at trace data trigger	R/W	0 to 1	1
Ud-56	18356	47B4h	Trigger 2 level setting at trace data trigger	R/W	0 to 100	1%
Ud-57	18357	47B5h	Trigger 2 activation selection at trace signal trigger	R/W	0 to 1	1
Ud-58	18358	47B6h	Trigger condition selection	R/W	0 to 3	1
Ud-59	18359	47B7h	Trigger point setting	R/W	0 to 100	1%
Ud-60	18360	47B8h	Sampling time setting	R/W	1 to 10	1
UE-01	18401	47E1h	EzSQ execution cycle	R/W	0 to 1	1
UE-02	18402	47E2h	EzSQ enable setting	R/W	0 to 2	1
UE-10	18410	47EAh	EzSQ User parameter U(00)	R/W	0 to 65535	1
UE-11	18411	47EBh	EzSQ User parameter U(01)	R/W	0 to 65535	1
UE-12	18412	47ECh	EzSQ User parameter U(02)	R/W	0 to 65535	1
UE-13	18413	47EDh	EzSQ User parameter U(03)	R/W	0 to 65535	1
UE-14	18414	47EEh	EzSQ User parameter U(04)	R/W	0 to 65535	1
UE-15	18415	47EFh	EzSQ User parameter U(05)	R/W	0 to 65535	1
UE-16	18416	47F0h	EzSQ User parameter U(06)	R/W	0 to 65535	1
UE-17	18417	47F1h	EzSQ User parameter U(07)	R/W	0 to 65535	1
UE-18	18418	47F2h	EzSQ User parameter U(08)	R/W	0 to 65535	1
UE-19	18419	47F3h	EzSQ User parameter U(09)	R/W	0 to 65535	1
UE-20	18420	47F4h	EzSQ User parameter U(10)	R/W	0 to 65535	1
UE-21	18421	47F5h	EzSQ User parameter U(11)	R/W	0 to 65535	1
UE-22	18422	47F6h	EzSQ User parameter U(12)	R/W	0 to 65535	1
UE-23	18423	47F7h	EzSQ User parameter U(13)	R/W	0 to 65535	1
UE-24	18424	47F8h	EzSQ User parameter U(14)	R/W	0 to 65535	1
UE-25	18425	47F9h	EzSQ User parameter U(15)	R/W	0 to 65535	1
UE-26	18426	47FAh	EzSQ User parameter U(16)	R/W	0 to 65535	1
UE-27	18427	47FBh	EzSQ User parameter U(17)	R/W	0 to 65535	1
UE-28	18428	47FCh	EzSQ User parameter U(18)	R/W	0 to 65535	1
UE-29	18429	47FDh	EzSQ User parameter U(19)	R/W	0 to 65535	1
UE-30	18430	47FEh	EzSQ User parameter U(20)	R/W	0 to 65535	1
UE-31	18431	47FFh	EzSQ User parameter U(21)	R/W	0 to 65535	1
UE-32	18432	4800h	EzSQ User parameter U(22)	R/W	0 to 65535	1
UE-33	18433	4801h	EzSQ User parameter U(23)	R/W	0 to 65535	1
UE-34	18434	4802h	EzSQ User parameter U(24)	R/W	0 to 65535	1
UE-35	18435	4803h	EzSQ User parameter U(25)	R/W	0 to 65535	1

Function Code	Register No. (decimal)	Register No. (hexadecimal)	Function Name	R/W	Monitor Content and Setting Item	Data Resolution / Unit
UE-36	18436	4804h	EzSQ User parameter U(26)	R/W	0 to 65535	1
UE-37	18437	4805h	EzSQ User parameter U(27)	R/W	0 to 65535	1
UE-38	18438	4806h	EzSQ User parameter U(28)	R/W	0 to 65535	1
UE-39	18439	4807h	EzSQ User parameter U(29)	R/W	0 to 65535	1
UE-40	18440	4808h	EzSQ User parameter U(30)	R/W	0 to 65535	1
UE-41	18441	4809h	EzSQ User parameter U(31)	R/W	0 to 65535	1
UE-42	18442	480Ah	EzSQ User parameter U(32)	R/W	0 to 65535	1
UE-43	18443	480Bh	EzSQ User parameter U(33)	R/W	0 to 65535	1
UE-44	18444	480Ch	EzSQ User parameter U(34)	R/W	0 to 65535	1
UE-45	18445	480Dh	EzSQ User parameter U(35)	R/W	0 to 65535	1
UE-46	18446	480Eh	EzSQ User parameter U(36)	R/W	0 to 65535	1
UE-47	18447	480Fh	EzSQ User parameter U(37)	R/W	0 to 65535	1
UE-48	18448	4810h	EzSQ User parameter U(38)	R/W	0 to 65535	1
UE-49	18449	4811h	EzSQ User parameter U(39)	R/W	0 to 65535	1
UE-50	18450	4812h	EzSQ User parameter U(40)	R/W	0 to 65535	1
UE-51	18451	4813h	EzSQ User parameter U(41)	R/W	0 to 65535	1
UE-52	18452	4814h	EzSQ User parameter U(42)	R/W	0 to 65535	1
UE-53	18453	4815h	EzSQ User parameter U(43)	R/W	0 to 65535	1
UE-54	18454	4816h	EzSQ User parameter U(44)	R/W	0 to 65535	1
UE-55	18455	4817h	EzSQ User parameter U(45)	R/W	0 to 65535	1
UE-56	18456	4818h	EzSQ User parameter U(46)	R/W	0 to 65535	1
UE-57	18457	4819h	EzSQ User parameter U(47)	R/W	0 to 65535	1
UE-58	18458	481Ah	EzSQ User parameter U(48)	R/W	0 to 65535	1
UE-59	18459	481Bh	EzSQ User parameter U(49)	R/W	0 to 65535	1
UE-60	18460	481Ch	EzSQ User parameter U(50)	R/W	0 to 65535	1
UE-61	18461	481Dh	EzSQ User parameter U(51)	R/W	0 to 65535	1
UE-62	18462	481Eh	EzSQ User parameter U(52)	R/W	0 to 65535	1
UE-63	18463	481Fh	EzSQ User parameter U(53)	R/W	0 to 65535	1
UE-64	18464	4820h	EzSQ User parameter U(54)	R/W	0 to 65535	1
UE-65	18465	4821h	EzSQ User parameter U(55)	R/W	0 to 65535	1
UE-66	18466	4822h	EzSQ User parameter U(56)	R/W	0 to 65535	1
UE-67	18467	4823h	EzSQ User parameter U(57)	R/W	0 to 65535	1
UE-68	18468	4824h	EzSQ User parameter U(58)	R/W	0 to 65535	1
UE-69	18469	4825h	EzSQ User parameter U(59)	R/W	0 to 65535	1
UE-70	18470	4826h	EzSQ User parameter U(60)	R/W	0 to 65535	1
UE-71	18471	4827h	EzSQ User parameter U(61)	R/W	0 to 65535	1
UE-72	18472	4828h	EzSQ User parameter U(62)	R/W	0 to 65535	1
UE-73	18473	4829h	EzSQ User parameter U(63)	R/W	0 to 65535	1

Function Code	Register No. (decimal)	Register No. (hexadecimal)	Function Name	R/W	Monitor Content and Setting Item	Data Resolution / Unit
UF-02	18502	4846h	EzSQ user parameter UL(00) (High)	R/W	-2147483647 to 2147483647	1
(UF-03)	18503	4847h	(Low)			
UF-04	18504	4848h	EzSQ user parameter UL(01) (High)	R/W	-2147483647 to 2147483647	1
(UF-05)	18505	4849h	(Low)			
UF-06	18506	484Ah	EzSQ user parameter UL(02) (High)	R/W	-2147483647 to 2147483647	1
(UF-07)	18507	484Bh	(Low)			
UF-08	18508	484Ch	EzSQ user parameter UL(03) (High)	R/W	-2147483647 to 2147483647	1
(UF-09)	18509	484Dh	(Low)			
UF-10	18510	484Eh	EzSQ user parameter UL(04) (High)	R/W	-2147483647 to 2147483647	1
(UF-11)	18511	484Fh	(Low)			
UF-12	18512	4850h	EzSQ user parameter UL(05) (High)	R/W	-2147483647 to 2147483647	1
(UF-13)	18513	4851h	(Low)			
UF-14	18514	4852h	EzSQ user parameter UL(06) (High)	R/W	-2147483647 to 2147483647	1
(UF-15)	18515	4853h	(Low)			
UF-16	18516	4854h	EzSQ user parameter UL(07) (High)	R/W	-2147483647 to 2147483647	1
(UF-17)	18517	4855h	(Low)			
UF-18	18518	4856h	EzSQ user parameter UL(08) (High)	R/W	-2147483647 to 2147483647	1
(UF-19)	18519	4857h	(Low)			
UF-20	18520	4858h	EzSQ user parameter UL(09) (High)	R/W	-2147483647 to 2147483647	1
(UF-21)	18521	4859h	(Low)			
UF-22	18522	485Ah	EzSQ user parameter UL(10) (High)	R/W	-2147483647 to 2147483647	1
(UF-23)	18523	485Bh	(Low)			
UF-24	18524	485Ch	EzSQ user parameter UL(11) (High)	R/W	-2147483647 to 2147483647	1
(UF-25)	18525	485Dh	(Low)			
UF-26	18526	485Eh	EzSQ user parameter UL(12) (High)	R/W	-2147483647 to 2147483647	1
(UF-27)	18527	485Fh	(Low)			
UF-28	18528	4860h	EzSQ user parameter UL(13) (High)	R/W	-2147483647 to 2147483647	1
(UF-29)	18529	4861h	(Low)			
UF-30	18530	4862h	EzSQ user parameter UL(14) (High)	R/W	-2147483647 to 2147483647	1
(UF-31)	18531	4863h	(Low)			
UF-32	18532	4864h	EzSQ user parameter UL(15) (High)	R/W	-2147483647 to 2147483647	1
(UF-33)	18533	4865h	(Low)			

15

Chapter 15 Optional Cassettes





Contents

- 15.1 What This Chapter Explains 15-1
- 15.2 Installation of Optional Cassettes 15-1
- 15.3 Parameters Related to Optional Devices 15-2
 - 15.3.1 Common Settings of
Optional Cassettes..... 15-2
- 15.4 Feedback Option Overview 15-3
 - 15.4.1 Line Driver Interface
Feedback Option 15-3
- 15.5 Communication Option Overview 15-4
 - 15.5.1 Communication option
common setting 15-4
 - 15.5.2 Ethernet (Modbus-TCP) Option 15-5
 - 15.5.3 EtherCAT Option 15-5
 - 15.5.4 PROFIBUS Option 15-5
 - 15.5.5 PROFINET Option 15-5
 - 15.5.6 CC-Link Option..... 15-5
 - 15.5.7 DeviceNet Option..... 15-5
- 15.6 Terminal Extension Option Overview..... 15-6
 - 15.6.1 Analog Input/Output
Extension Option 15-6
- 15.7 Functional Safety
Expansion Option Overview..... 15-7
 - 15.7.1 Functional Safety Expansion Option..... 15-7

15.1 What This Chapter Explains

- This chapter describes optional cassettes that are able to connect to SJ-P1.
- For details, refer to the Basic / User's Guide each optional devices.

Note: The User's Guide is not banded with some option products (See Introduction). In this case, please contact your supplier or the nearest Hitachi sales office.

Symbol	Meanings
	General and troubleshooting questions
	Key points for a solution
	Notes
	Confirmation of procedures

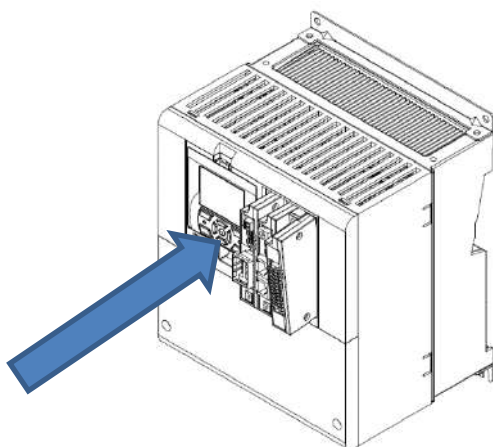

15.2 Installation of Optional Cassettes

- When inserting an optional cassette, remove the slot cover screws and straightly insert an optional cassette you want to use. Then set the optional cassette to be secured with the removed screws.
- Connection state of optional cassettes can be monitored on the option slot mounted state monitors [dA-81] (SLOT1) to [dA-83] (SLOT3).

Connection Part	Name	Description
SLOT1	Optional cassette slot 1	For connecting various optional cassettes.
SLOT2	Optional cassette slot 2	For connecting various optional cassettes. The encoder feedback option (P1-FB) must be connected to the slot 2.
SLOT3	Optional cassette slot 3	For connecting various optional cassettes. The functional Safety option (P1-FS) must be connected to the slot 3.

15.3 Parameters Related to Optional Devices

15.3.1 Common Settings of Optional Cassettes

■ Operation selection when option error occurs (operation when communication error occurs between P1 main unit and optional cassette)



- I want to continue operation of the inverter even when a communication error is detected between the P1 main unit and an optional cassette.



- The behavior when an option error (E060, E069/E070, E079/E080, E089) occurs can be set for each slot ([oA-10]/[oA-20]/[oA-30]).
- For option errors, refer to the each option's Basic and User's Guide.

■ Parameter.

Name	Code	Data range (unit)	Description
Operation selection at an option error (SLOT-1)	[oA-10]	00 (Error)	When an error related to the SLOT-1 option occurs, the inverter will be into the trip state.
		01 (Ignore error (keep running))	SLOT-1 option related errors are ignored.
Operation selection at an option error (SLOT-2)	[oA-20]	00 (Error)	When an error related to the SLOT-2 option occurs, the inverter will be into the trip state.
		01 (Ignore error)	SLOT-2 option related errors are ignored.
Operation selection at an option error (SLOT-3)	[oA-30]	00 (Error)	When an error related to the SLOT-2 option occurs, the inverter will be into the trip state.
		01 (Ignore error)	SLOT-2 option related errors are ignored.

■ RUN command behavior at option startup.



- Start up of the motor is delayed when communication option is connected.



- At using the communication option, when "RUN command selection at start up" is set to Disable (00), the RUN command is accepted after confirming the connection between the option and the inverter.

■ Parameter.

Name	Code	Data range (unit)	Description
RUN command selection at start up (SLOT-1)	[oA-13]	00 (Disable)	RUN command is disabled until the SLOT-1 option is ready.
		01 (Enable)	RUN command is enabled even if the SLOT-1 option is not ready.
RUN command selection at start up (SLOT-2)	[oA-23]	00 (Disable)	RUN command is disabled until the SLOT-2 option is ready.
		01 (Enable)	RUN command is enabled even if the SLOT-2 option is not ready.
RUN command selection at start up (SLOT-3)	[oA-33]	00 (Disable)	RUN command is disabled until the SLOT-3 option is ready.
		01 (Enable)	RUN command is enabled even if the SLOT-3 option is not ready.



- When "Ignore error (01)" is selected for "Operation selection at an option error ([oA-10]/[oA-20]/[oA-30])", even when an operation stop command is given via an optional cassette, there is a case what an operation may not be stopped via the optional cassette.
Make sure that the construct system so that it can be shut down even in an emergency.
- Option errors except for E060, E069/E070, E079/E080, and E089, as well as errors exclusive to optional cassettes (E090 to E109) are disabled. (An error occurs and the inverter stops operating.)
- This function is invalid with the P1-FS option.

15.4 Feedback Option Overview

15.4.1 Line Driver Interface Feedback Option

- Option P1-FB for line driver is an interface option to inverters which is corresponding to 5 VDC line driver output for incremental type rotary encoder.
- Combining this option with an inverter to detect and feedback rotation speed of the motor with encoder suppresses speed fluctuation and realizes high precision operation.
- In addition, by inputting pulse string position command, you can execute position control, synchronous operation, orientation function, etc. For details, refer to the following sections contained herein and P1-FB user's guide.

■ On settings of encoder
"12.9.17 Use Encoder"

■ On control mode
"12.9.1 Selection of Control Mode"

■ On settings of pulse train input
"12.4.6 Making Command from Pulse Train Input"

■ On position control
"12.17.7 Pulse Train Position Control Settings"
"12.17.8 Stopping at the defined Positions"
"12.17.9 Absolute Position Control Settings"

■ Related parameters
Refer to the aforementioned sections contained herein and P1-FB user's guide.

15.5 Communication Option Overview

15.5.1 Communication option common setting



- When using a communication option, do not change “CF-11 resistor data selection” from “00:(A, V).”
- Only the parameters related to each communication option are described in this chapter. For details, refer to the User's Guide for each option.

■ Operation setting for communication error

- This function is for P1-EN, P1-PB, P1-PN, P1-ECT, P1-CCL and P1-DN. The function is disabled when other optional cassettes are used.
- For details, refer to the each User's Guide.

■ Parameter

Item	Parameter	Data	Description
Communication Watch Dog Timer (SLOT-1)	[oA-11]	0.00 to 100.00 (s)	Judgment time of communication error
Action selection at a communication error (SLOT-1)	[oA-12]	00	An error occurs
		01	An error occurs after deceleration stop
		02	Ignore
		03	Free-run stop without error
		04	Deceleration stop without error
Communication Watch Dog Timer (SLOT-2)	[oA-21]	0.00 to 100.00 (s)	Judgment time of communication error
Action selection at a communication error (SLOT-2)	[oA-22]	00	An error occurs
		01	An error occurs after deceleration stop
		02	Ignore
		03	Free-run stop without error
		04	Deceleration stop without error
Communication Watch Dog Timer (SLOT-3)	[oA-31]	0.00 to 100.00 (s)	Judgment time of communication error
Action selection at a communication error (SLOT-3)	[oA-32]	00	An error occurs
		01	An error occurs after deceleration stop
		02	Ignore
		03	Free-run stop without error
		04	Deceleration stop without error

15.5.2 Ethernet (Modbus-TCP) Option

- Ethernet communication is performed with Modbus-TCP protocol.
For details, refer to the P1-EN User's Guide.

■ Related parameters (Ethernet option)

Item	Parameter
IP-address selection	[oH-01]
Communication speed (port-1)	[oH-02]
Communication speed (port-2)	[oH-03]
Ethernet communication timeout	[oH-04]
Modbus TCP Port No.(IPv4)	[oH-05]
Modbus TCP Port No.(IPv6)	[oH-06]
IPv4 IP address (1) to (4) Gr.1	[oL-01] to [oL-04]
IPv4 subnet mask (1) to (4) Gr.1	[oL-05] to [oL-08]
IPv4 default gateway (1) to (4) Gr.1	[oL-09] to [oL-12]
IPv6 IP address (1) to (8) Gr.1	[oL-20] to [oL-27]
IPv6 Prefix of subnet, Gr.1	[oL-28]
IPv6 default gateway (1) to (8) Gr.1	[oL-29] to [oL-36]
IPv4 IP address (1) to (4) Gr.2	[oL-40] to [oL-43]
IPv4 subnet mask (1) to (4) Gr.2	[oL-44] to [oL-47]
IPv4 default gateway (1) to (4) Gr.2	[oL-48] to [oL-51]
IPv6 IP address (1) to (8) Gr.2	[oL-60] to [oL-67]
IPv6 Prefix of subnet, Gr.2	[oL-68]
IPv6 default gateway (1) to (8) Gr.2	[oL-69] to [oL-76]

15.5.3 EtherCAT Option

- Use this option to perform EtherCAT communication.
For details, refer to the P1-ECT User's Guide.

■ Related parameters

- None

15.5.4 PROFIBUS Option

- Use this option to perform PROFIBUS communication.
For details, refer to the P1-PB User's Guide.

■ Related parameters (PROFIBUS option)

Item	Parameter
PROFIBUS Node address	[oH-20]
PROFIBUS Telegram group selection	[oH-24]
Writing register 1 to 10, Gr.A	[oJ-01] to [oJ-10]
Reading register 1 to 10, Gr.A	[oJ-11] to [oJ-20]
Writing register 1 to 10, Gr.B	[oJ-21] to [oJ-30]
Reading register 1 to 10, Gr.B	[oJ-31] to [oJ-40]
Writing register 1 to 10, Gr.C	[oJ-41] to [oJ-50]
Reading register 1 to 10, Gr.C	[oJ-51] to [oJ-60]

15.5.5 PROFINET Option

- Use this option to perform PROFINET communication.
For details, refer to the P1-PN User's Guide.

■ Related parameters (PROFINET option)

Item	Parameter
PROFINET Telegram group selection	[oH-34]
Writing register 1 to 10, Gr.A	[oJ-01] to [oJ-10]
Reading register 1 to 10, Gr.A	[oJ-11] to [oJ-20]
Writing register 1 to 10, Gr.B	[oJ-21] to [oJ-30]
Reading register 1 to 10, Gr.B	[oJ-31] to [oJ-40]
Writing register 1 to 10, Gr.C	[oJ-41] to [oJ-50]
Reading register 1 to 10, Gr.C	[oJ-51] to [oJ-60]

15.5.6 CC-Link Option

- Use this option to perform P1-CCL communication.
For details, refer to the P1-CCL User's Guide.

■ Related parameters

- None

15.5.7 DeviceNet Option

- Use this option to perform DeviceNet communication.
For details, refer to the P1-DN User's Guide.

■ Related parameters (DeviceNet option)

Item	Parameter
DeviceNet node address (MAC ID)	[oH-40]
DeviceNet assembly instance number selection	[oH-41]
DeviceNet speed unit selection	[oH-42]
DeviceNet flexible Gr. Format selection	[oH-44]
DeviceNet idle mode action selection	[oH-45]

15.6 Terminal Extension Option

Overview

15.6.1 Analog Input/Output Extension Option

- This is an option for extending analog inputs and outputs (voltage/current) on the control circuit terminal block.
For details, refer to the P1-AG User's Guide.

■ Related parameters (P1-AG option)

Item	Parameter
[Ai4] Filter time constant	[oE-01]
[Ai4] Start value	[oE-03]
[Ai4] End value	[oE-04]
[Ai4] Start rate	[oE-05]
[Ai4] End rate	[oE-06]
[Ai4] Start point selection	[oE-07]
[Ai5] Filter time constant	[oE-11]
[Ai5] Start value	[oE-13]
[Ai5] End value	[oE-14]
[Ai5] Start rate	[oE-15]
[Ai5] End rate	[oE-16]
[Ai5] Start point selection	[oE-17]
[Ai6] Filter time constant	[oE-21]
[Ai6] Start value	[oE-23]
[Ai6] End value	[oE-24]
[Ai6] Start rate	[oE-25]
[Ai6] End rate	[oE-26]
[Ai4] Voltage/Current bias adjustment	[oE-28]
[Ai4] Voltage/Current gain adjustment	[oE-29]
[Ai5] Voltage/Current bias adjustment	[oE-30]
[Ai5] Voltage/Current gain adjustment	[oE-31]
[Ai6] Voltage bias adjustment	[oE-32]
[Ai6] Voltage gain adjustment	[oE-33]
[Ai4] Window comparator upper limit	[oE-35]
[Ai4] Window comparator lower limit	[oE-36]
[Ai4] Window comparator hysteresis width	[oE-37]
[Ai5] Window comparator upper limit	[oE-38]
[Ai5] Window comparator lower limit	[oE-39]
[Ai5] Window comparator hysteresis width	[oE-40]
[Ai6] Window comparator upper limit	[oE-41]
[Ai6] Window comparator lower limit	[oE-42]
[Ai6] Window comparator hysteresis width	[oE-43]

Item	Parameter
[Ai4] Temporal operation level set at disconnection or compare event	[oE-44]
[Ai4] Temporal operation level implementation timing	[oE-45]
[Ai5] Temporal operation level set at disconnection or compare event	[oE-46]
[Ai5] Temporal operation level implementation timing	[oE-47]
[Ai6] Temporal operation level set at disconnection or compare event	[oE-48]
[Ai6] Temporal operation level implementation timing	[oE-49]
[Ao3] Output monitor selection	[oE-50]
[Ao4] Output monitor selection	[oE-51]
[Ao5] Output monitor selection	[oE-52]
[Ao3] Output filter time constant	[oE-56]
[Ao3] Data type selection	[oE-57]
[Ao3] Bias adjustment	[oE-58]
[Ao3] Gain adjustment	[oE-59]
Adjustment mode [Ao3] output level	[oE-60]
[Ao4] Output filter time constant	[oE-61]
[Ao4] Data type selection	[oE-62]
[Ao4] Bias adjustment	[oE-63]
[Ao4] Gain adjustment	[oE-64]
Adjustment mode [Ao4] output level	[oE-65]
[Ao5] Output filter time constant	[oE-66]
[Ao5] Data type selection	[oE-67]
[Ao5] Bias adjustment	[oE-68]
[Ao5] Gain adjustment	[oE-69]
Adjustment mode [Ao5] output level	[oE-70]

■ Related monitors

Item	Parameter
Analog input/output status monitor	[dA-60]
Analog input [Ai4] monitor	[dA-64]
Analog input [Ai5] monitor	[dA-65]
Analog input [Ai6] monitor	[dA-66]

15.7 Functional Safety Expansion

Option Overview

15.7.1 Functional Safety Expansion Option

- This is an option for expanding safety functions.
For details, refer to the P1-FS User's Guide.

■ Related parameters (P1-FS option)

Item	Parameter
Safety option input display selection	[oC-01]
SS1-A deceleration time setting	[oC-10]
SLS-A deceleration time setting	[oC-12]
SLS-A speed upper limit (Forward)	[oC-14]
SLS-A speed upper limit (Reverse)	[oC-15]
SDI-A deceleration time setting	[oC-16]
SDI-A direction limit mode	[oC-18]
SS1-B deceleration time setting	[oC-20]
SLS-B deceleration time setting	[oC-22]
SLS-B speed upper limit (Forward)	[oC-24]
SLS-B speed upper limit (Reverse)	[oC-25]
SDI-B deceleration time setting	[oC-26]
SDI-B direction limit mode	[oC-28]

■ Related monitors

Item	Parameter
Safety option hardware monitor	[dA-46]
Safety option function monitor	[dA-47]

(Memo)

16

Chapter 16 ProDriveNext / EzSQ





Contents

16.1 What This Chapter Explains	16-1
16.2 “ProDriveNext”	16-2
16.2.1 Connecting PC and Inverter.....	16-2
16.2.2 What You Can Do with “ProDriveNext”.	16-2
16.3 Program Operation Function EzSQ.....	16-3
16.3.1 EzSQ Specifications	16-3
16.3.2 EzSQ Use Procedure.....	16-4
16.3.3 EzSQ Function Related Parameters.....	16-5
16.4 Trace Functions	16-7
16.4.1 Trace Function Specifications	16-7
16.4.2 Trace Function Use Procedure	16-7
16.4.3 Trace Function Related Parameters	16-8

16.1 What This Chapter Explains

This chapter provides the inverter side details related to PC software “ProDriveNext”.

For more details, see the instruction manuals of “ProDriveNext” and “SJ series P1 Easy-Sequence Function(EzSQ) Programming Guide (NT252*X).

Symbol	Meanings
	General and troubleshooting questions
	Key points for a solution
	Notes
	Confirmation of procedures

16.2 “ProDriveNext”

Q

- I want to manage parameters by PC.
- I want to perform an automatic operation using the program operation function (EzSQ).
- I want to check the monitor data graphically at the time of error.

16.2.1 Connecting PC and Inverter

- Install Hitachi’s “ProDriveNext” to your PC.
- Connect the inverter and the PC using a USB cable.

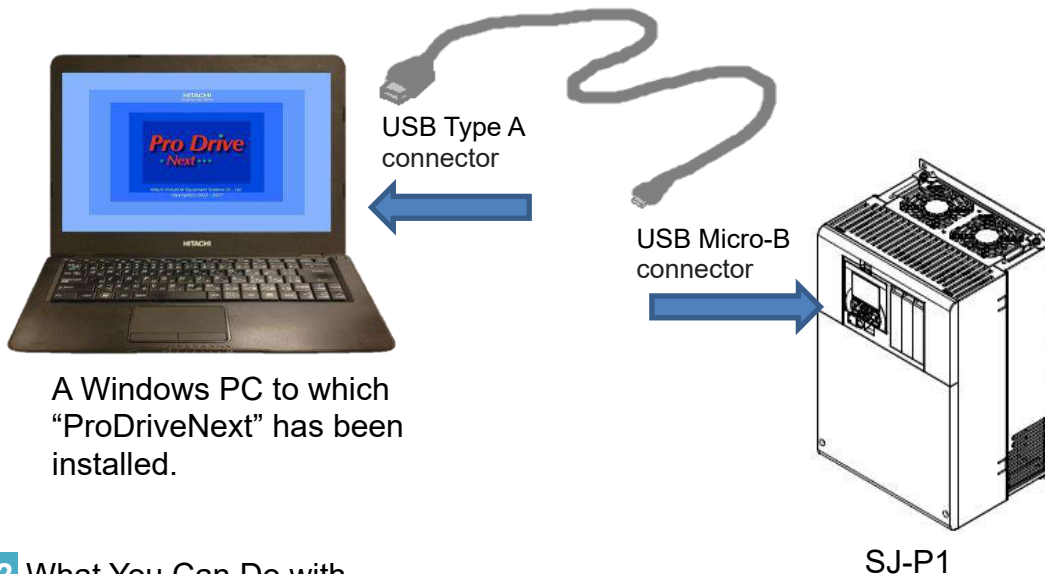

16.2.2 What You Can Do with “ProDriveNext”

A

- Parameter setting function
 - You can configure various parameter settings such as setting parameters individually and searching parameters changed from the factory setting.
 - Parameters can be stored and read as CSV file format.
- Monitor function
 - You can set arbitrary parameters and conduct monitoring accordingly.
 - Monitor data can be stored and read out in the CSV file format.
- Trace function
 - This function enables you to set parameters and triggers in order to show data graphically at occurrence of a trigger.
 - Traced data can be stored and read as CSV file format.

A

- With the PC tool “ProDriveNext”, the following functions are usable: wizard function for supporting an operation setting; function for writing a parameter to and reading out a parameter from a file; function for creating a program and downloading to inverters; function for tracing an error when it occurs; etc.
- For installation procedure, see the instruction manual of “ProDriveNext”.

- Functions for program operation (EzSQ)
 - You can download the program to the inverter to customize the inverter for you.
 - With its BASIC-like entry-type or selection-type programming function, EzSQ enables you to freely designate input/output and RUN/STOP of the inverter.
 - Programs can be stored and read out in the CSV file format.

!

- For more details, see the instruction manuals of “ProDriveNext” and “SJ series P1 Easy-Sequence Function(EzSQ) Programming Guide (NT252*X)”.
- “ProDriveNext” must be used under the following settings:
 - [CF-02] RS485 communication node address = “1”.
 - [CF-11] Register data conversion function (A,V↔%) = “0”.
 - [CF-50] USB communication node address = “1”.

16.3 Program Operation Function EzSQ

16.3.1 EzSQ Specifications

A

- EzSQ is a function which realizes easy sequence operations when you create a program with “ProDriveNext” and download the program to the inverter.

!

- For programming details, refer to SJ-P1 EzSQ Programming Guide (NT252*X). The note (*1) in the table below are the specifications added or changed in SJ-P1 Ver 2.00 or later.

■ Specifications.

Item		Specification	
Language specification	Linguistic form	BASIC-like	
	Programming device	Windows PCs (For applicable OSs, see the instruction manual of “ProDriveNext”).	
	Execution form	<ul style="list-style-type: none"> Interpreter type Execution interval: 1 ms per step (SJ-P1- Ver 1.XX) Select either 1 ms or 2 ms per step (parameter [UE-01]). (*1) Subroutine call availability: Max. 8 nests Multitasking capability: Max. 5 tasks 	
	Program capacity	Up to 1,024 steps per task, hence up to 7,680 bytes in total of 5 tasks	
	Programming tool	<ul style="list-style-type: none"> “ProdriveNext” (Edit, Viewer, Program grammar check, Program download, upload, program clear and others) 	
Input / output related function	External input	Contact signal	24 VDC open collector input (input terminals 1 to 9, A, and B)
		Program activation	Select “Activated by PRG terminal” or “Always active”.
		General purpose input terminal	Max. 11 terminals (X (00) to X (10) <incl. A and B terminals>)
	General purpose analog input	XA (0) to XA(5) (Ai1 to Ai6 terminal input. (*1) XA(3) to XA(5) require analog input / output option P1-AG.)	
	External output	General purpose output terminal	Max. 7 terminals (Y (00) to Y (06) <incl. relay contact outputs>)
		General purpose analog output	YA (0) to YA (5) (Allocated to FM, Ao1, and Ao2 terminals. (*1) YA(3) to YA(5) require analog input / output option P1-AG.)
Reserved word	Instruction	①Program control instruction: Loop (for) / Unconditional branches (go to) / Time control (wait) / Subroutines (call, sub) / Conditional branches (if then, ifs then, select case, until, while) / others (entry, end, cont, inc, dec)	
		②Arithmetic instruction: 4 arithmetic operations (+, -, *, /) / Modulus operator (mod) / Assignment (=) / Absolute value (abs) / Logical operations (or, and, xor, not)	
		③Input/output controlling: General purpose input/output (bit input, word input, bit output, word output) / Inverter input terminal reading	
		④Timer controlling: Delay operation / Timer control (*1)	
		⑤Parameter controlling: Monitor/setting can be changed by designating an operator display code.	
	Number of variables	User-defined variable	U (00) to U (63) / 64 variables
		User-defined variable (LONG)	UL (00) to UL (15) / 16 variables
		Main speed command	SET-Freq
		Acceleration time	ACCEL
		Deceleration time	DECEL
		Monitor variable	FM, Iout, Dir, PID-FB, F-CNV, Tmon, Vout, Power, RUN-Time, ON-Time, PlsCnt, POS (*1), STATUS, DCV, ERR CNT, ERR (1) to ERR (10), RETRY (1) to RETRY (10) (*1)
		General purpose input contact	X (00) to X (10) / 11 variables
		General purpose output contact	Y (00) to Y (06) / 7 variables (2 of them are for relay contact outputs)
		Internal user contact	UB (00) to UB (15) / 16 variables
		Internal timer contact	TD (0) to TD (15) / 16 variables
Inverter input / output	Specify from intelligent input / output terminal functions		
User monitor	Displaying arbitrary data on the inverter operator / 5 variables		
User trip	Making the inverter trip during programming / 10 variables		

16.3.2 EzSQ Use Procedure

■ Flow up until execution of EzSQ.

No.	Description	Remarks
1	Create an EzSQ program with "ProDriveNext".	Inverter set up tool software "ProDriveNext" is required.
2	Compile the program in the form executable in the inverter. As soon as the compiling begins, the grammar of EzSQ program is checked. If there is an error, the compiling is suspended and the error message appears.	
3	Download the compiled EzSQ program to the inverter and save it to the non-volatile memory of inverter. *1)	
4	Set the necessary parameters for the inverter.	See "16.3.3 EzSQ Function Related Parameters".
5	Set the EzSQ enable setting [UE-02] to Enable (01 or 02).	
6	When [UE-02] is set to 01, the PRG terminal is turned ON and the program will be executed. When [UE-02] is set to 02, the program will be executed automatically after the power supply is turned ON. *2)	
7	The operation state of EzSQ can be checked on the inverter operator keypad.	



*1) By saving the program to the memory element incorporated in the inverter (data flash), you will also be able to execute the program after the power supply is returned ON. If the downloaded program hasn't been saved to the memory element, the program will be erased when the inverter power supply is shut off. When you create a program and carry out debugs including operation check, it is recommended to save after the debugs are completed instead of saving to the memory element.

*2) Once the program is downloaded to the inverter, the EzSQ program becomes executable with the inverter disconnected from the PC.



- Because SJ-P1 doesn't share the same parameter numbers, setting range, the minimum unit, etc. with conventional models like SJ700/L700, the EzSQ programs created for these conventional models may not be used as is. Make sure to carry out re-examination of the programs and operation checks.
- When a reset or trip reset using the RS terminal is performed during execution of an EzSQ program, the program counter will be reset and the program will be executed from the lead.

16.3.3 EzSQ Function Related Parameters

■ EzSQ function related parameters (monitors).

Name	Code	Data range (unit)	Description
Program download monitor	[db-01]	00 (without program)	Program hasn't been downloaded.
		01 (with program)	Program has been downloaded.
Program No. monitor	[db-02]	0000 to 9999	Program No. of downloaded program is displayed.
Program counter (Task-1)	[db-03]	1 to 1024	For each task (Task-1 to Task-5), the line number which is being executed is monitored.
Program counter (Task-2)	[db-04]		
Program counter (Task-3)	[db-05]		
Program counter (Task-4)	[db-06]		
Program counter (Task-5)	[db-07]		
User monitor 0	[db-08]	-2147483647 to 2147483647	The data which was output to Umon (00) to Umon (04) in the program is monitored. [db-08] ← Umon (00) [db-10] ← Umon (01) [db-12] ← Umon (02) [db-14] ← Umon (03) [db-16] ← Umon (04)
User monitor 1	[db-10]		
User monitor 2	[db-12]		
User monitor 3	[db-14]		
User monitor 4	[db-16]		
Analog output monitor YA0	[db-18]	0.00 to 100.00(%)	The data which was output to YA (00) to YA (05) in the program is monitored. YA0 [db-18] ← YA(00) YA1 [db-19] ← YA(01) YA2 [db-20] ← YA(02) YA3 [db-21] ← YA(03) YA4 [db-22] ← YA(04) YA5 [db-23] ← YA(05)
Analog output monitor YA1	[db-19]		
Analog output monitor YA2	[db-20]		
Analog output monitor YA3	[db-21]		
Analog output monitor YA4	[db-22]		
Analog output monitor YA5	[db-23]		

■ Related parameters (settings).

Name	Code	Data range (unit)	Description
EzSQ execution cycle	[UE-01]	00	1ms/Step
		01	2ms/Step (same as SJ700/L700)
EzSQ enable setting	[UE-02]	00	EzSQ function disabled
		01	EzSQ function enabled (Activated by PRG terminal)
		02	EzSQ function enabled (Always active)
EzSQ user parameters U (00) to U (63)	[UE-10] to [UE-73]	0 to 65535	U (00) to U (63) on the program is operable via the operator keypad.
EzSQ user parameters UL (00) to UL (15)	[UF-02] to [UF-32]	-2147483647 to 2147483647	UL (00) to UL (15) on the program is operable via the operator keypad.
Main speed input source selection, 1st-motor / Sub speed input source selection, 1st-motor	[AA101] [AA102]	14	To set frequency in the SET-Freq variable, select 14 (program function) for these parameters. *1)
RUN command input source selection, 1st-motor	[AA111]	00	To operate and stop the inverter using the variables FW and RV respectively, select 00 (terminal [FW]/[RV]) for this RUN command parameter. *1)
Acceleration/Deceleration time input source selection	[AC-01]	04	To set acceleration and deceleration time in the ACCEL and DECEL variables respectively, select 04 (Function EzSQ) for this parameter.
Input terminal 1 to 9, A or B function	[CA-01] to [CA-11]	099	PRG: EzSQ function PRG terminal *2)
Input terminal 1 to 9, A or B function	[CA-01] to [CA-11]	086 to 096	MI1 to MI11: General purpose input 1 to 9, A or B
Output terminal 11 to 16,AL function.(16 and AL are Relay output terminal)	[CC-01] to [CC-07]	069 to 075	MO1 to MO7: General purpose output 1 to 7
Analogue input [Ai1] terminal	- (setting not required)	—	XA (0): General purpose analog input (0 to 10 V / 0 to 20 mA)
Analogue input [Ai2] terminal	- (setting not required)	—	XA (1): General purpose analog input (0 to 10 V / 0 to 20 mA)
Analogue input [Ai3] terminal	- (setting not required)	—	XA (2): General purpose analog input (-10 to 10 V)
[FM] Output monitor selection	[Cd-03]	[db-18],[db-19]	YA (0) to YA(5): General purpose analog output
[Ao1] Output monitor selection	[Cd-04]	[db-20],[db-21]	
[Ao2] Output monitor selection	[Cd-05]	[db-22],[db-23]	



- *1) By setting the Main speed input source selection [AA101] and RUN command input source selection [AA111] to values other than above table, the operator keypad / analog input value can be used as RUN command / frequency reference, for example.
- *2) Assign 099 [PRG] to the input terminal only if you select 01 (Activated by PRG terminal) for [UE-02] (EzSQ function selection).



- As for variables that require adjustment on the actual inverter, you can change the data on the operator keypad without connecting the inverter to a PC if you have designated the variables to user parameters ([UE-10] to [UE-73] and/or [UF-02] to [UF-32]).

■ EzSQ program activation timing.

- (1) When [UE-02] (Activated by [PRG] terminal) is set to 01,
- Assign 099 [PRG] terminal to any of the input terminals 1 to 9, A and B. The EzSQ program will be executed when the PRG terminal is turned ON.

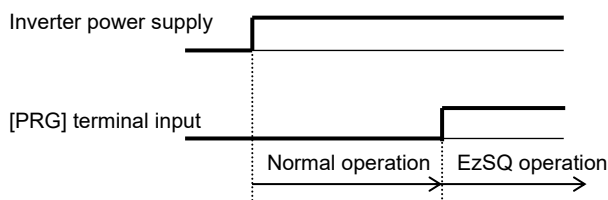

- (2) When [UE-02] (Always active) is set to 02,
- The EzSQ program is constantly active while the inverter power supply is turned ON.

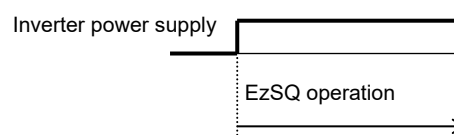

16.4 Trace Functions

16.4.1 Trace Function Specifications



- The trace function is a function for obtaining and accumulating the inverter monitor data under the set conditions.
- With “ProDriveNext”, accumulated data (accumulated trace data) can be uploaded, shown graphically, and stored.



- For more details, see the instruction manual of “ProDriveNext”.

Specifications.

Item	Description
Number of trace data	Monitor data: Max. 8 data Signal: Max. 8 signals (Select from the Input/output terminal function.)
Accumulated trace data size	8kbytes
Sampling time (interval)	Select from 0.2 ms, 0.5 ms, 1 ms, 2 ms, 5 ms, 10 ms, 50 ms, 100 ms, 500 ms, and 1000 ms.
Number of sampling points	It varies depending on the number of trace data, the number of signals, and data size of parameters to be traced. Ex. 953 sampling points if “the number of trace data is 4; the number of signals is 1; and the data size of them is respectively 2 bytes”.
Trace starting method	“ProDriveNext”, parameter setting, input terminal (DTR (data trace starting signal))
Trigger condition	2 conditions (4 conditions in total by the combination of them) Select either Trip or Trace data (monitor data, signal). Trigger level and trigger point can be set.
Others	<ul style="list-style-type: none"> • Trace function state signals ([WFT] is ON in a trigger stand-by state, and [TRA] is ON during tracing) • To graphically show or store accumulated trace data, “ProDriveNext” is required.

16.4.2 Trace Function Use Procedure

Trace function use procedure.

No.	Description	Remarks
1	Enable the trace function. (Set [Ud-01] to 01(Enable).)	See “16.4.3 Trace Function Related Parameters”. (These items can also be set with “ProDriveNext”.)
2	Set the number of data ([Ud-03]) and signals ([Ud-04]) to be traced.	
3	Select parameters to be traced. ([Ud-10] to [Ud-17])	
4	Select whether a signal to be traced is of input terminal function or output terminal function. ([Ud-20], [Ud-23], [Ud-26], [Ud-29], [Ud-32], [Ud-35], [Ud-38], [Ud-41]) Then, select a signal (terminal function) to be traced. (Input: [Ud-21], [Ud-24], [Ud-27], [Ud-30], [Ud-33], [Ud-36], [Ud-39], [Ud-42]) (Output: [Ud-22], [Ud-25], [Ud-28], [Ud-31], [Ud-34], [Ud-37], [Ud-40], [Ud-43])	
5	Select and set trigger conditions. ([Ud-50] to [Ud-59])	
6	Select sampling time (interval). ([Ud-60])	
7	Start tracing. (Set [Ud-02] to 01(Start).) (This item can also be set with the input terminal function DTR or “ProDriveNext”.)	
8	The inverter enters the trace stop state as tracing is completed. *1) *2) (Wait until the inverter finishes tracing.) When it’s done, [Ud-02] will be changed to 00 (Stop.)	
9	Read out, show graphically, and store the accumulated trace data, using “ProDriveNext”. *3)	“ProDriveNext” is required.



- *1) Note that the accumulated trace data will be erased if the inverter power supply is shut off.
- *2) Do not interrupt tracing while it is being executed because some accumulated trace data may be remained.
- *3) During data readout, trace data may be missing. In such a case, carry out readout again.

16.4.3 Trace Function Related Parameters

■ Related parameters.

Name	Code	Data range (unit)	Description
Trace function enable	[Ud-01]	00	Disable
		01	Enable
Trace start	[Ud-02]	00	Stop tracing.
		01	Start tracing and enters the trigger stand-by state.
Number of trace data setting	[Ud-03]	0 to 8	Select the number of data to be traced.
Number of trace signals setting	[Ud-04]	0 to 8	Select the number of I/O signals to be traced.
Trace data 0 to 7 selection	[Ud-10] to [Ud-17]	See the trace target data described in the following section.	Select monitor parameters to be traced.
Trace signal 0 to 7 input/output selection	[Ud-20], [Ud-23], [Ud-26], [Ud-29], [Ud-32], [Ud-35], [Ud-38], [Ud-41]	00	Trace the input terminals. When 00 is selected, [Ud-21], [Ud-24], [Ud-27], [Ud-30], [Ud-33], [Ud-36], [Ud-39], [Ud-42] are enabled.
		01	Trace the output terminals. When 01 is selected, [Ud-22], [Ud-25], [Ud-28], [Ud-31], [Ud-34], [Ud-37], [Ud-40], [Ud-43] are enabled.
Trace signal 0 to 7 input terminal selection	[Ud-21], [Ud-24], [Ud-27], [Ud-30], [Ud-33], [Ud-36], [Ud-39], [Ud-42]	See options for [CA-01].	Set input terminal number to be traced.
Trace signal 0 to 7 output terminal selection	[Ud-22], [Ud-25], [Ud-28], [Ud-31], [Ud-34], [Ud-37], [Ud-40], [Ud-43]	See options for [CC-01].	Set output terminal number to be traced.
Trace trigger 1, 2 selection	[Ud-50], [Ud-54]	00	Set the occurrence of a trip as a trigger
		01 to 08	Trace data 0 to 7 is trigger.
		09 to 16	Trace signal 0 to 7 is trigger.
Trigger 1,2 activation selection at trace data trigger	[Ud-51], [Ud-55]	00	Recording starts when the trace data rises above the trigger level.
		01	Recording starts when the trace data falls below the trigger level.
Trigger 1,2 level setting at trace data trigger	[Ud-52], [Ud-56]	0 to 100 (%)	Adjust the trigger level, considering the Max. value of each selected monitor parameter as 100%.
Trigger 1,2 activation selection at trace signal trigger	[Ud-53], [Ud-57]	00	Recording starts when the signal is ON.
		01	Recording starts when the signal is OFF.
Trigger condition selection	[Ud-58]	00	Recording starts when trigger 1 is satisfied.
		01	Recording starts when trigger 2 is satisfied.
		02	Record when either of trigger 1 or 2 is satisfied.
		03	Record when both triggers 1 and 2 are satisfied.
Trigger point setting	[Ud-59]	0 to 100 (%)	Determine the trigger point for recording trace data.
Sampling time setting	[Ud-60]	01 to 10	Obtain data at the set intervals. 01 (0.2ms), 02 (0.5ms), 03 (1ms), 04 (2ms), 05 (5ms), 06 (10ms), 07 (50ms), 08 (100ms), 09 (500ms), 10 (1,000ms)
Input terminal function	[CA-01] to [CA-11]	108	DTR: Data trace starting signal
Output terminal function	[CC-01] to [CC-07]	078	WFT: Trace function trigger stand-by signal
	[CC-01] to [CC-07]	079	TRA: Trace function during-tracing signal

■ Trace target data.

- Set the following monitor parameters to the trace data 0 to 7 selection ([Ud-10] to [Ud-17]).

Parameter No. and Name	Data Size (bytes)	Parameter No. and Name	Data Size (bytes)
dA-01 (Output frequency monitor)	4	db-30 (PID1 feedback value 1 monitor)	4
dA-02 (Output current monitor)	2	db-32 (PID1 feedback value 2 monitor)	4
dA-04 (Frequency reference monitor (after calculation))	4	db-34 (PID1 feedback value 3 monitor)	4
dA-08 (Detect speed monitor)	4	db-36 (PID2 feedback value monitor)	4
dA-12 (Output frequency monitor (signed))	4	db-38 (PID3 feedback value monitor)	4
dA-14 (Frequency upper limit monitor)	4	db-40 (PID4 feedback value monitor)	4
dA-15 (Torque reference monitor (after calculation))	2	db-42 (PID1 target value monitor (after calculation))	4
dA-16 (Torque limit monitor)	2	db-44 (PID1 feedback data monitor (after calculation))	4
dA-17 (Output torque monitor)	4	db-50 (PID1 output monitor)	2
dA-18 (Output voltage monitor (RMS))	4	db-51 (PID1 deviation monitor)	2
dA-30 (Input power monitor)	2	db-52 (PID1 deviation 1 monitor)	2
dA-34 (Output power monitor)	2	db-53 (PID1 deviation 2 monitor)	2
dA-38 (Motor temperature monitor)	2	db-54 (PID1 deviation 3 monitor)	2
dA-40 (DC bus voltage monitor)	2	db-55 (PID2 output monitor)	2
dA-41 (BRD load rate monitor)	2	db-56 (PID2 deviation monitor)	2
dA-42 (Electronic thermal load rating monitor (MTR))	2	db-57 (PID3 output monitor)	2
dA-43 (Electronic thermal load rating monitor (CTL))	2	db-58 (PID3 deviation monitor)	2
dA-61 (Analog input [Ai1] monitor)	2	db-59 (PID4 output monitor)	2
dA-62 (Analog input [Ai2] monitor)	2	db-60 (PID4 deviation monitor)	2
dA-63 (Analog input [Ai3] monitor)	2	db-64 (PID feed forward monitor)	4
dA-64 (Analog input [Ai4] monitor)	2	dC-15 (Cooling fin temperature monitor)	2
dA-65 (Analog input [Ai5] monitor)	2	FA-01 (Main speed reference setting or monitor)	4
dA-66 (Analog input [Ai6] monitor)	2	FA-02 (Sub-speed reference setting or monitor)	4
dA-70 (Pulse train input monitor (internal))	2	FA-15 (Torque reference setting or monitor)	2
dA-71 (Pulse train input monitor (option))	2	FA-16 (Torque bias setting or monitor)	2
db-18 (Analog output monitor YA0)	2	FA-30 (PID1 set-point 1 setting or monitor)	4
db-19 (Analog output monitor YA1)	2	FA-32 (PID1 set-point 2 setting or monitor)	4
db-20 (Analog output monitor YA2)	2	FA-34 (PID1 set-point 3 setting or monitor)	4
db-21 (Analog output monitor YA3)	2	FA-36 (PID2 set-point setting or monitor)	4
db-22 (Analog output monitor YA4)	2	FA-38 (PID3 set-point setting or monitor)	4
db-23 (Analog output monitor YA5)	2	FA-40 (PID4 set-point setting or monitor)	4

■ Data tracing time.

- Data tracing time varies depending on the sampling time setting [Ud-60], the number of trace data [Ud-03], the number of trace signals [Ud-04], and data size of monitor parameters to be traced.

No. of Trace Data [Ud-03]	Data Tracing Time *1) *2)			
	Sampling time [Ud-60]: 01 (0.2ms) (Min.)		Sampling time [Ud-60]: 10 (1,000ms) (Max.)	
	If all are 4-byte data,	If all are 2-byte data,	If all are 4-byte data,	If all are 2-byte data,
1	344ms (1,724 points)	576ms (2,880 points)	1,724s (1,724 points)	2,880s (2,880 points)
2	190ms (953 points)	344ms (1,724 points)	953s (953 points)	1,724s (1,724 points)
3	131ms (656 points)	245ms (1,228 points)	656s (656 points)	1,228s (1,228 points)
4	100ms (500 points)	190ms (953 points)	500s (500 points)	953s (953 points)
5	80ms (402 points)	155ms (778 points)	402s (402 points)	778s (778 points)
6	67ms (336 points)	131ms (656 points)	336s (336 points)	656s (656 points)
7	57ms (288 points)	113ms (568 points)	288s (288 points)	568s (568 points)
8	50ms (252 points)	100ms (500 points)	252s (252 points)	500s (500 points)

*1) For cases when the number of trace signals other than 0 is selected for [Ud-04]. *2) "Points" in parentheses indicate the number of sampling points.

(Memo)

17

Chapter 17 Connection with PLC

Contents

17.1 What This Chapter Explains	17-1
17.2 Connection with PLC	17-2

17.1 What This Chapter Explains

This chapter describes the method for connecting the inverter with a programmable logic controller (PLC). Perform connection in accordance with the guidance given hereunder. Incorrect wiring may result in unexpected operations and breakage of the inverter and PLC. Furthermore, make sure to carefully read "Chapter 1 Safety Instructions/Risks" for safety work.

17.2 Connection with PLC

(1) Connecting input terminals to a programmable logic controller

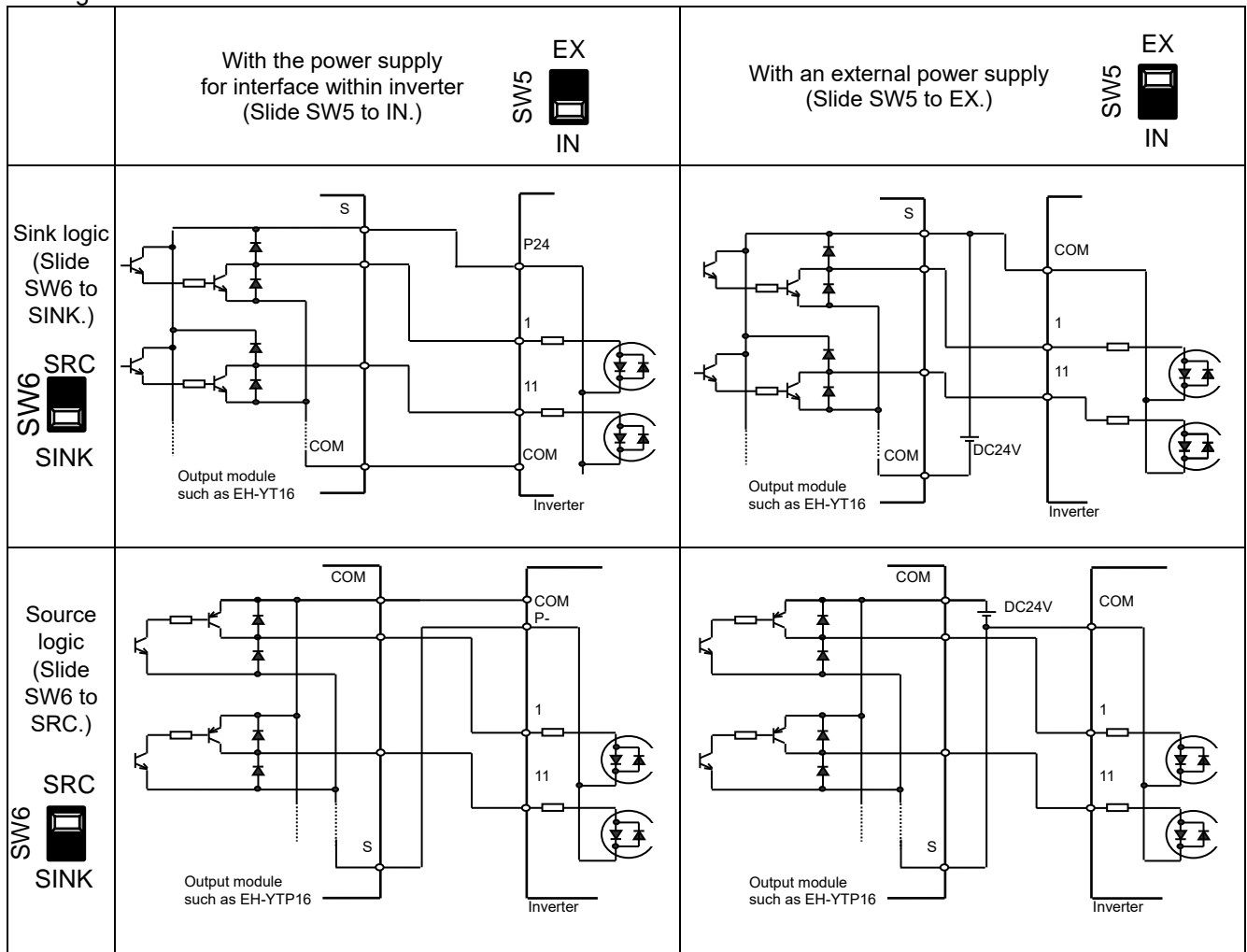

(2) Connecting output terminals to a programmable logic controller

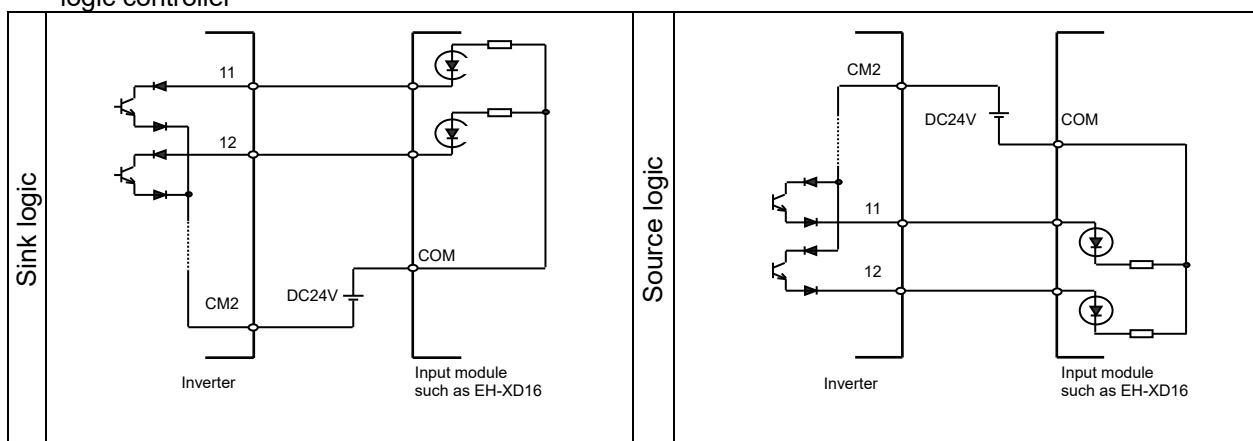

18





Chapter 18 Tips/FAQ/Troubleshooting

Contents

- 18.1 What This Chapter Explains 18-1
- 18.2 Self Diagnosis of Problems 18-2
- 18.3 Checking Error Information..... 18-3
 - 18.3.1 Checking Trip Information 18-3
 - 18.3.2 Checking Retry Information 18-5
- 18.4 Troubleshooting for Protection Functions
 Related Error 18-6
- 18.5 Troubleshooting for Warning Functions
 Related Error 18-33
 - 18.5.1 Checking the Warning Display 18-33
 - 18.5.2 Checking Setting Inconsistencies 18-38
 - 18.5.3 Checking Display Messages 18-39
- 18.6 How to Check
 When Something Is Wrong 18-42

18.1 What This Chapter Explains

This chapter provides troubleshooting information for protection function related errors, warning function related warnings, and “When something seems wrong”.

Symbol	Meanings
	General and troubleshooting questions
	Key points for a solution
	Notes
	Confirmation of procedures



- Read this chapter first when the inverter doesn't operate as intended or a problem occurred. Address these issues according to the circumstances by referring to the next and subsequent sections.

18.2 Self Diagnosis of Problems

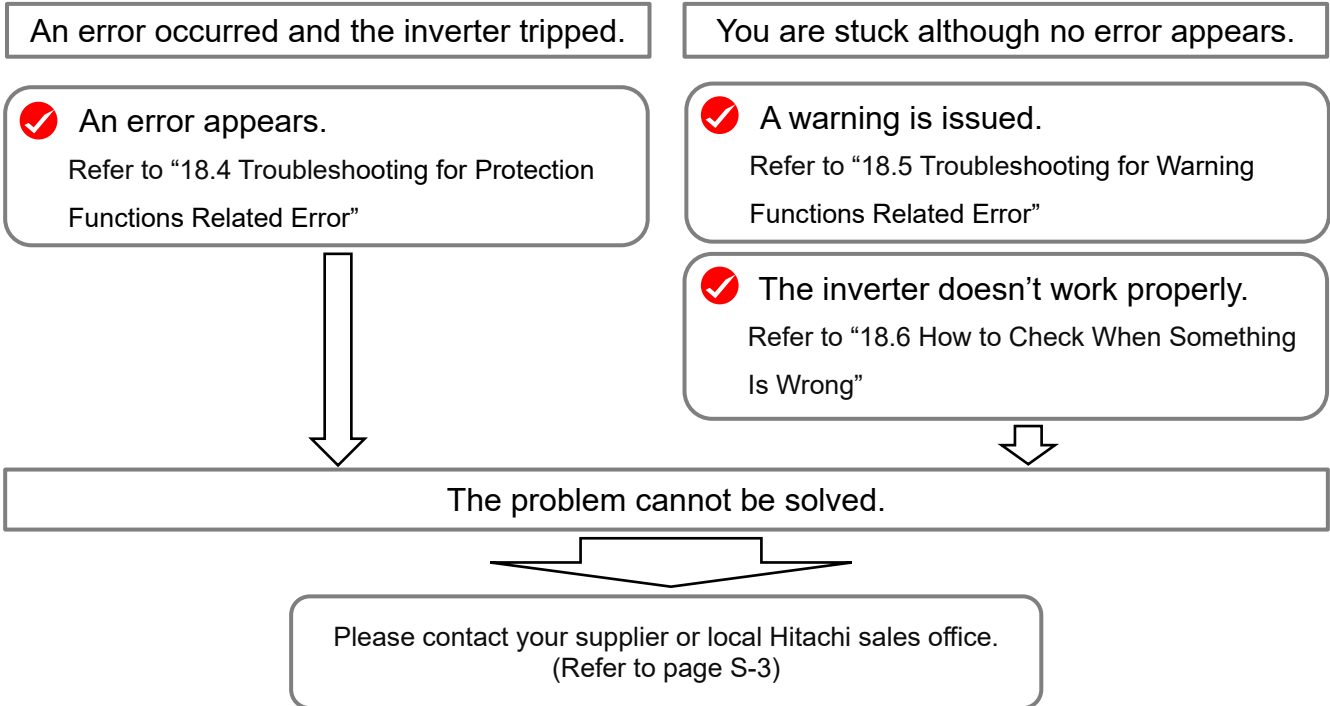

Before making an inquiry, please check the information shown on the right and have them ready.

(1) Inverter model, (2) Manufacturing number (MFG No.), (3) Date of purchase, and (4) Content of the inquiry

18.3 Checking Error Information

18.3.1 Checking Trip Information

Q

The inverter generated an error and tripped. You want to see the information of the moment the error occurred.

A

- Up to 10 trips in the past is displayed as the trip history.
- The latest trip history is displayed on the trip monitor 1.
- The following data items are displayed on the monitor:
 - Error factor for trip
 - Output frequency (Hz) at trip
 - Output current (A) at trip
 - Main circuit DC voltage (V) at trip
 - Operation state when a trip occurred.
(See next page for details)
 - State 1: Inverter operation status (0 to 8)
 - State 2: LAD(Accel/Decel) operation status (0 to 5)
 - State 3: Inverter control status (0 to 11)
 - State 4: Motor drive limit status (0 to 6)
 - State 5: Special feature operation status (0 to 6)
 - Cumulative inverter operating time (h) before trip
 - Cumulative inverter power-on time (h) before trip

!

- The information of the moment of error occurrence may not be fetched properly if the inverter is forcibly turned OFF by its hardware.
- Values of respective data items may be reset to 0 when an error occurred and the inverter entered the trip condition.
- For a ground fault or a momentary overcurrent event, the current may be recorded in a value lower than the actual value.
- The trip monitor and the trip count monitor can be cleared by initialization of the trip history.

■ Display of occurring trip

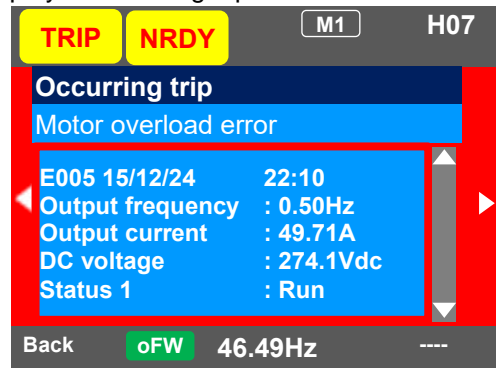

■ Parameter

Item	Parameter	Data	Description
Trip monitor 1 to 10	Trip whole display	See above data items.	On the parameter monitor, you can view data items 1) to 7) in sequence by UP/DOWN keys.
Trip count monitor	Trip whole display	0 to 65535 (Counts)	Trip count data is stored in the inverter.

■ “Trip whole display” for checking the history

- You can look through the history with the arrow keys.

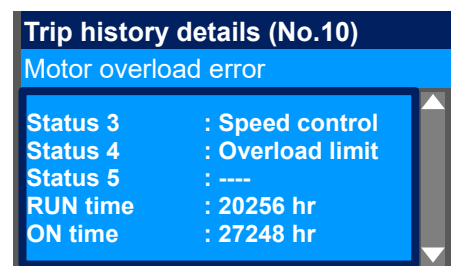
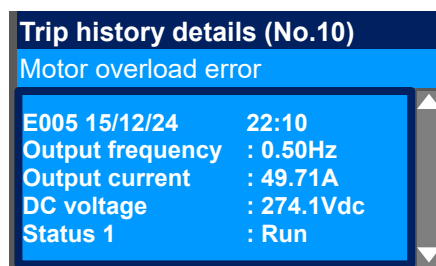
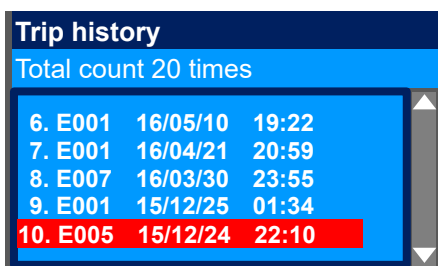
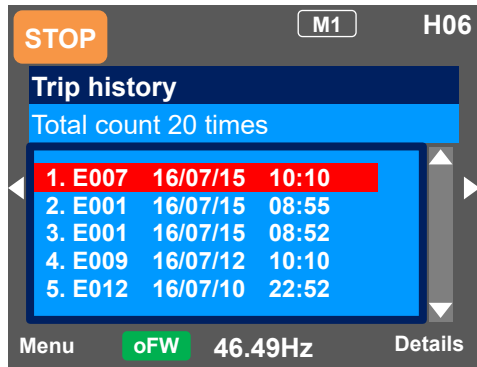

- Details of Operation state 1 to 5 when a trip or a retry occurred.

State 1: Inverter operation status

Num.	Contents
0	At power supply turned on During Reset User initialize in progress
1	Detecting ground fault
2	Stopping
3	Transitioning to Run state
4	Operation standby (Or detecting magnetic pole position)
5	Running (Including DB, Servo ON, and Forcing)
6	Transitioning to stop state
7	Waiting for retry
8	Retrying

State 2: LAD(Accel/Decel) operation status

Num.	Contents
0	Output shut-off, DB, Servo-ON, Forcing
1	At start, Forward/Reverse switching, Reduced voltage start
2	Acceleration state
3	Deceleration state
4	Constant speed state
5	Restarting

State 3: Inverter control status

Num.	Contents
0	Output shut off
1	During speed control mode
2	Starting
3	DC braking
4	Forcing
5	Servo ON
6	During position control mode
7	During torque control mode
8	Restarting
9	Detecting magnetic pole position
10	Detecting ground fault
11	Auto-tuning R1, R2, L measuring

State 4: Motor drive limit status

Num.	Contents
0	No motor drive limit
1	Overcurrent suppressed (high display priority)
2	Overload limit
3	During overvoltage suppression
4	Torque limit (display priority is low)
5	Upper/lower and jump frequency settings are limited
6	Minimum frequency setting is limited

State 5: Special feature operation status

Num.	Contents
0	No special function state
1	During Auto-tuning
2	In simulation mode
3	The scheduler function is operating
4	Emergency forced operation mode
5	Bypass mode
6	During emergency operation mode

18.3.2 Checking Retry Information



- Want to see the information of the moment of error occurrence because a retry was executed after the inverter generated the error.



- The last 9 retry histories are displayed.
- The latest retry history is displayed on the retry monitor 1.
- The following data items are displayed on the monitor:
 - 1) Error factor for retry
 - 2) Output frequency (Hz) at retry
 - 3) Output current (A) at retry
 - 4) Main circuit DC voltage (V) at retry
 - 5) Operation state when a retry occurred.
(See previous page for details)
State 1: Inverter operation status (0 to 8)
State 2: LAD(Accel/Decel) operation status (0 to 5)
State 3: Inverter control status (0 to 11)
State 4: Motor drive limit status (0 to 6)
State 5: Special feature operation status (0 to 6)
 - 6) Cumulative inverter operating time (h) before retry
 - 7) Cumulative inverter power-on time (h) before retry



- While a retry is underway, the inverter tries to continue running. For a trip after a retry, the trip information is recorded on the trip history.
- The information of the moment of error occurrence may not be fetched properly if the inverter is forcibly turned OFF by its hardware.
- For a momentary overcurrent event, the current may be recorded in a value lower than the actual value.

Parameter

Item	Parameter	Data	Description
Retry monitor 1 to 10	Why retry history	See above data items.	On the parameter monitor, you can view data items 1) to 7) in sequence by UP/DOWN keys.

" Why retry history " for checking the history

- You can look through the history with the arrow keys.

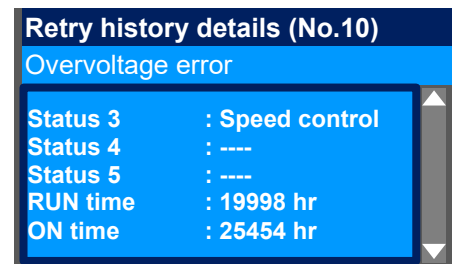
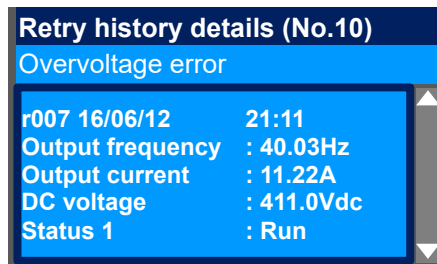
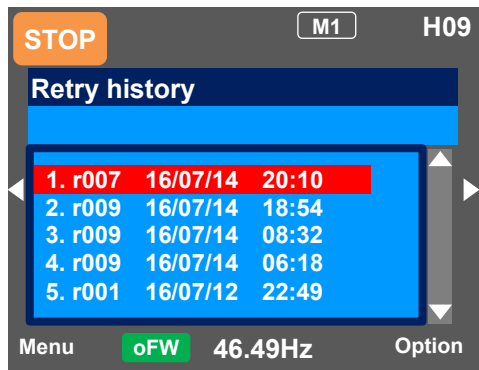

18.4 Troubleshooting for Protection Functions Related Error

- The corrective action depends on the error number.
Please refer to the corresponding section in the table below.

Error No.	Error Name	Explanation Page
E001	Overcurrent error	18-8
E005	Motor overload error *2) *3)	18-9
E006	Braking resistor overload error	18-10
E007	Overvoltage error	18-11
E008	Memory error *1)	18-12
E009	Under-voltage error	18-13
E010	Current detector error *1)	18-14
E011	CPU error *1)	18-14
E012	External trip error	18-15
E013	USP error	18-15
E014	Ground fault error *1)	18-16
E015	Power supply overvoltage error	18-16
E016	Instantaneous power failure error	18-17
E019	Temperature detector error *1)	18-17
E020	Cooling fan rotation speed reduction temperature error *1)	18-18
E021	Temperature error	18-18
E024	Input open-phase error	18-19
E030	IGBT error	18-19
E034	Output open-phase error	18-20

*1) As a major failure error, the output terminal function [MJA] turns ON. And these errors could not be canceled with input terminal 028[RS]. However, "E020" can be reset if the inverter temperature drops sufficiently.

*2) When [bC112] "Electronic thermal decrease function enable" = 01 (Overload accumulated value subtraction mode = Enabled (initial value)), it can be reset immediately after an [E005] error occurs, but the overload accumulated value is not cleared.
Therefore, if restarting immediately after resetting, the overload accumulated value will soon reach 100% and the [E005] error may occur again. In that case, wait for a while and restart.

Error No.	Error Name	Explanation Page
E035	Thermistor error	18-20
E036	Brake error	18-21
E038	Low-speed range overload error	18-21
E039	Controller(Inverter) overload error *3)	18-22
E040	Operator keypad disconnection error	18-23
E041	RS485 communication error	18-23
E042	RTC error	18-24
E043	EzSQ invalid instruction error	18-24
E044	EzSQ nesting count error	18-25
E045	EzSQ execution error	18-25
E050	EzSQ user-assigned error 0	18-26
E051	EzSQ user-assigned error 1	18-26
E052	EzSQ user-assigned error 2	18-26
E053	EzSQ user-assigned error 3	18-26
E054	EzSQ user-assigned error 4	18-26
E055	EzSQ user-assigned error 5	18-26
E056	EzSQ user-assigned error 6	18-26
E057	EzSQ user-assigned error 7	18-26
E058	EzSQ user-assigned error 8	18-26
E059	EzSQ user-assigned error 9	18-26

*3) When a controller overload error [E039] occurred, or a motor overload error [E005] occurred in the condition that [bC112] set to 00, the inverter does not accept a reset for 10 s. Wait for a while before performing a reset operation.

Error No.	Error Name	Explanation Page
E060	Option 1 error 0	18-26
E061	Option 1 error 1	18-26
E062	Option 1 error 2	18-26
E063	Option 1 error 3	18-26
E064	Option 1 error 4	18-26
E065	Option 1 error 5	18-26
E066	Option 1 error 6	18-26
E067	Option 1 error 7	18-26
E068	Option 1 error 8	18-26
E069	Option 1 error 9	18-26
E070	Option 2 error 0	18-27
E071	Option 2 error 1	18-27
E072	Option 2 error 2	18-27
E073	Option 2 error 3	18-27
E074	Option 2 error 4	18-27
E075	Option 2 error 5	18-27
E076	Option 2 error 6	18-27
E077	Option 2 error 7	18-27
E078	Option 2 error 8	18-27
E079	Option 2 error 9	18-27
E080	Option 3 error 0	18-27
E081	Option 3 error 1	18-27
E082	Option 3 error 2	18-27
E083	Option 3 error 3	18-27
E084	Option 3 error 4	18-27
E085	Option 3 error 5	18-27
E086	Option 3 error 6	18-27
E087	Option 3 error 7	18-27
E088	Option 3 error 8	18-27
E089	Option 3 error 9	18-27

Error No.	Error Name	Explanation Page
E090	STO shutoff error	18-28
E091	STO internal error	18-28
E092	STO path 1 error	18-28
E093	STO path 2 error	18-28
E094	FS option internal error	18-28
E095	FS option path 1 error	18-28
E096	FS option path 2 error	18-28
E097	FS option communication error	18-28
E100	Encoder disconnection error	18-28
E104	Position control range error	18-29
E105	Speed deviation error	18-29
E106	Position deviation error	18-30
E107	Over-speed error	18-30
E110	Contact error	18-31
E112	Feedback option connection error	18-31
E120	PID start error	18-32

E001 Overcurrent error

A large current flowing in the inverter results in a failure. To prevent this, the inverter turns OFF its output. By setting the parameters, you can perform retries for a fixed number of times without generating an error. Overcurrent level can be set in the [bb160].

E001

Occurrence ▶	Estimated cause(s) ▶	Exemplar measures to be taken
Error occurred abruptly during operation.	<ul style="list-style-type: none"> A steep load change occurred. 	<ul style="list-style-type: none"> [bA120] "Overcurrent suppression enable" and [bA122] / [bA126] "Overload restriction 1/2 mode selection" are effective to suppress overcurrent. When the vector control is used, the situation may be improved by adjusting the response to control in [HA115].
	<ul style="list-style-type: none"> Hunting of motor 	<ul style="list-style-type: none"> The situation may be improved by setting the IM motor capacity in [Hb102], the number of IM poles in [Hb103], or the auto-tuning selection in [HA-01]. The situation may be improved by adjusting the Stabilization constant in [HA110].
Error occurred during acceleration.	<ul style="list-style-type: none"> Insufficient acceleration time Insufficient acceleration torque Load inertia is large. Friction torque is large. 	<ul style="list-style-type: none"> Setting longer acceleration time in [FA-10] can ease the insufficient acceleration torque. When acceleration torque is required, the situation may be improved by adjusting the [Hb141] manual torque boost value, or by operating the inverter and making adjustments with control method in [AA121]. Re-examination of load condition may improve the situation.
Error occurred during deceleration.	<ul style="list-style-type: none"> Insufficient deceleration time Insufficient regenerative torque Load inertia is large. 	<ul style="list-style-type: none"> Setting longer deceleration time in [FA-12] can ease the insufficient regenerative torque. When regenerative torque is required, the situation may be improved by adjusting the [Hb141] manual torque boost value, or by operating the inverter and making adjustments with control method in [AA121]. Re-examination of load condition may improve the situation.
Error occurred right after a RUN command input.	<ul style="list-style-type: none"> A ground fault has occurred. Output line is short-circuited or in open phase. Output element failure 	<ul style="list-style-type: none"> The inverter may be broken if the error persists even when the power of inverter only is turned ON again after the power was turned OFF and the output line to the motor was removed. If the issue is solved when the output line to the motor is removed, you need to check the wiring and/or motor.
	<ul style="list-style-type: none"> Motor is locked. Load inertia is large. 	<ul style="list-style-type: none"> Error may occur when the motor rotation is locked. The situation may be improved by taking a measure for the case "Error occurred during acceleration".
Error occurred right after power was turned ON.	<ul style="list-style-type: none"> Output element failure Current detector failure 	<ul style="list-style-type: none"> Failure output element or current detector may be the cause. An investigation and repair are required.
Error occurred after long hours of use.	<ul style="list-style-type: none"> System environment changes 	<ul style="list-style-type: none"> The situation may be improved by reducing the motor load, or performing a system maintenance (e.g., cleaning the fan to be driven and removing clogging in the duct).
	<ul style="list-style-type: none"> Aging deterioration 	<ul style="list-style-type: none"> If the issue is not solved by reduction of the load and system maintenance, aging deterioration of a life-limited component may be the cause. A repair is required.

E005 Motor overload error

The built-in electronic thermal function monitors the output current of the inverter and when a motor overload is detected, the inverter turns OFF its output. The inverter trips according to the setting of the motor electronic thermal function.

When a motor overload error occurred, the inverter does not accept a reset input for 10 seconds. *1)



Occurrence ▶	Estimated cause(s) ▶	Exemplar measures to be taken
Error occurred after a fixed period of operation.	<ul style="list-style-type: none"> • Operation under heavy load condition has continued. 	<ul style="list-style-type: none"> • Re-examination of operation condition or correction of load condition may improve the situation.
	<ul style="list-style-type: none"> • Thermal level is set high. 	<ul style="list-style-type: none"> • When the [bC110] Electronic thermal level setting is not appropriate, re-examination of the setting may improve the situation.
Error occurred during acceleration.	<ul style="list-style-type: none"> • Insufficient acceleration torque • Load inertia is large. • Friction torque is large. 	<ul style="list-style-type: none"> • Setting longer acceleration time in [FA-10] can ease the insufficient acceleration torque. • When acceleration torque is required, the situation may be improved by adjusting the [Hb141] boost function in, or by operating the inverter and making adjustments with control method in [AA121].
	<ul style="list-style-type: none"> • A function to suppress overcurrent is at work. 	<ul style="list-style-type: none"> • A factor for overcurrent may have been occurred. Re-examination of acceleration time or load condition is required.
Error occurred during deceleration.	<ul style="list-style-type: none"> • Load inertia is large. 	<ul style="list-style-type: none"> • Setting longer deceleration time in [FA-12] can ease the insufficient regenerative torque. • When regenerative torque is required, the situation may be improved by adjusting the [Hb141] manual torque boost value, or by operating the inverter and adjusting with control method in [AA121]. • Re-examination of load condition may improve the situation.
	<ul style="list-style-type: none"> • A function to suppress overvoltage is at work. 	<ul style="list-style-type: none"> • Current may increase as a result of suppressing overvoltage. Re-examination of the deceleration time [FA-12] or load conditions are required..
Error occurred after long hours of use.	<ul style="list-style-type: none"> • System environment changes 	<ul style="list-style-type: none"> • The situation may be improved by reducing the motor load, or performing a system maintenance (e.g., cleaning the fan to be driven and removing clogging in the duct).
	<ul style="list-style-type: none"> • Aging deterioration 	<ul style="list-style-type: none"> • If the issue is not solved by reduction of the load and system maintenance, aging deterioration of a life-limited component may be the cause. A repair is required.

*1) When a Motor overload error [E005] occurred in the condition that [bC112] set to 00, the inverter does not accept a reset for 10 sec. Wait for a while before performing a reset operation.

When [bC112] "Electronic thermal decrease function enable" = 01 (Overload accumulated value subtraction mode = Enabled (initial value)), it can be reset immediately after an [E005] error occurs, but the overload accumulated value is not cleared. Therefore, if restarting immediately after resetting, the overload accumulated value will soon reach 100% and the [E005] error may occur again. In that case, wait for a while and restart.

E006 Braking resistor overload error

E006

When the use rate of inverter's braking resistor operation circuit (BRD) exceeds the use rate set beforehand in [bA-60], the inverter turns OFF its output.

Occurrence ▶	Estimated cause(s) ▶	Exemplar measures to be taken
Error occurred during deceleration.	<ul style="list-style-type: none"> • Insufficient deceleration time • Load inertia is large. • Capacity of braking resistor is small. 	<ul style="list-style-type: none"> • Setting longer deceleration time in [FA-12] may improve the situation that the motor is rapidly decelerated. If deceleration time cannot be shortened, choice of resistor must be re-examined.
Error occurred during operation.	<ul style="list-style-type: none"> • Continuous regenerative operation • Capacity of braking resistor is small. 	<ul style="list-style-type: none"> • Due to the high regenerative power returned from the motor, the resistor may not be able to completely consume it. Load condition or choice of resistor must be re-examined.
	<ul style="list-style-type: none"> • Rotated by external force. 	<ul style="list-style-type: none"> • The resistor may not be able to fully consume the power because the fan is rotated by a strong wind, or because the regenerative power returned from the motor increases when loads are lowered by a crane or the like. Load condition or choice of resistor must be re-examined.
Error occurred during repetitive operations.	<ul style="list-style-type: none"> • Repetition cycle of operation is high. 	<ul style="list-style-type: none"> • Reduction of repetition cycle of operation may improve the situation. Adjustment of deceleration time in [FA-12] and re-examination of choice of resistor may also improve the situation.

E007 Overvoltage error

Too high P-N voltage results in a failure. To prevent this, the inverter turns OFF its output. When P-N voltage exceeds approx. 410Vdc (200V class) or approx. 820Vdc (400V class), the output is turned OFF. By setting the parameters, you can perform retries for a fixed number of times without generating an error.



Occurrence ▶	Estimated cause(s) ▶	Exemplar measures to be taken
Error occurred during deceleration.	<ul style="list-style-type: none"> • Insufficient deceleration time • Load inertia is large. 	<ul style="list-style-type: none"> • Setting longer deceleration time in [FA-12] may improve the situation when the motor is rapidly decelerated. If deceleration time cannot be shortened, you need to re-examine load condition, enable overvoltage suppression function in [bA140] and [bA146], or use a braking resistor, braking unit, or regenerative converter.
Error occurred during operation.	<ul style="list-style-type: none"> • Load inertia is large. 	<ul style="list-style-type: none"> • If load inertia is large, high regenerative power returns from the motor; hence an overvoltage is likely to occur. You need to re-examine load condition, enable overvoltage suppression function in [bA140] and [bA146], or use a braking resistor, braking unit, or regenerative converter.
	<ul style="list-style-type: none"> • Rotated by external force (fan, crane). 	<ul style="list-style-type: none"> • An overvoltage is likely to occur if motor rotation speed exceeds the output frequency (rotation speed) of inverter. You need to re-examine load condition, enable overvoltage suppression function in [bA140] and [bA146], or use a braking resistor, braking unit, or regenerative converter.
Error occurred during stop.	<ul style="list-style-type: none"> • Abnormality of Power Supply voltage. 	<ul style="list-style-type: none"> • Power supply voltage may be raised or fluctuated. Re-examination of power supply environment or use of an AC reactor may improve the situation.
Error occurred during drooping control	<ul style="list-style-type: none"> • Mutual interference caused by 2 inverters trying to control motors strictly. 	<ul style="list-style-type: none"> • When 2 motors driving a same shaft are controlled by 2 inverters, both the inverters attempt to generate torques, which may result in control divergence. The situation may be improved by setting one of the inverters to P control. See "12.11.3 Drooping Control Operation".

E008 Memory error

If the built-in memory has problems, the inverter turns OFF its output. CPU error may be issued instead.

The inverter recovers by re-turning ON the power; however, you need to check that there is no problem in parameters. The data which has been backed up on the operator keypad beforehand may be restored.



Occurrence ▶	Estimated cause(s) ▶	Exemplar measures to be taken
<p>Error occurred some time after the power was turned ON.</p>	<ul style="list-style-type: none"> Noise is mixed. 	<ul style="list-style-type: none"> A physical countermeasure such as placing a shielding plate may be required to avoid external noises.
<p>Power has been unintentionally turned OFF before. (Main power supply/ R0T0 power supply/ External 24 VDC into P+,P- terminals)</p>	<ul style="list-style-type: none"> Power-off during memory access. 	<ul style="list-style-type: none"> You need to restore the data by using the data which has been backed up on the operator keypad beforehand. For data backup to the operator keypad, refer to "9.6 Copy Data!" If the data cannot be restored, initialization is required. See "12.2.2 Initialization of Inverter". If the data cannot be restored by initialization, a repair is required of the inverter.

E009 Undervoltage error

A decrease of the main power supply of inverter results in a circuit breakage. To prevent this, the inverter turns OFF its output. When P-N voltage falls below approx. 160 VDC (200V class) or approx. 320 VDC (400V class), the output is turned OFF. By setting the parameters, you can perform retries for a fixed number of times without generating an error. Furthermore, undervoltage error during stop can be disabled by setting.



Occurrence ▶	Estimated cause(s) ▶	Exemplar measures to be taken
There was a power failure.	<ul style="list-style-type: none"> Power supply voltage decreased. 	<ul style="list-style-type: none"> If the internal power supply hasn't been fully turned OFF, it is possible to re-start the inverter after the power supply is recovered, by setting the retry function while it is still on.
Error occurred with the start of operation.	<ul style="list-style-type: none"> Power supply voltage decreased. Power supply capacity is insufficient. 	<ul style="list-style-type: none"> When power supply voltage decreases or power supply capacity is insufficient, re-examination of power supply environment is required.
The inverter doesn't start.	<ul style="list-style-type: none"> Power supply voltage is insufficient. 	<ul style="list-style-type: none"> Perform power supplying in accordance with the inverter voltage class.
Error occurred after long hours of use.	<ul style="list-style-type: none"> System environment changes Capacitor deterioration Circuit failure 	<ul style="list-style-type: none"> If an undervoltage occurs frequently, the inverter may have reached its end of life or be broken down. A repair is required.

E010 Current detector error

If the built-in current detector has problems, the inverter turns OFF its output.

E010

Occurrence ▶	Estimated cause(s) ▶	Exemplar measures to be taken
Error occurred after power was turned ON.	<ul style="list-style-type: none"> • Current detector circuit is broken. • A noise source is nearby. 	<ul style="list-style-type: none"> • If the error recurs after a reset operation, the current detector circuit may be broken down. A repair is required. • When there is a noise source nearby, the situation may be improved by taking a noise countermeasure such as keeping the noise source away or placing a shielding plate.
Error occurred after long hours of use.	<ul style="list-style-type: none"> • Current detector circuit is broken. 	<ul style="list-style-type: none"> • If the error recurs after a reset operation, the current detector circuit may be broken down. A repair is required.

E011 CPU error

When a malfunction or problem occurs in the built-in CPU, the inverter turns OFF its output and then displays the error.

If the inverter doesn't recover by re-turning ON the power, the CPU or control circuit is likely to be broken.

E011

Occurrence ▶	Estimated cause(s) ▶	Exemplar measures to be taken
Error occurred abruptly.	<ul style="list-style-type: none"> • The internal CPU or control circuit is broken. • A noise source is nearby. 	<ul style="list-style-type: none"> • The inverter may recover by a reset operation, re-turning ON the power, or initialization operation. When the inverter recovered, an initialization must be executed. • If the inverter doesn't recover, the CPU may be broken down. A repair is required. • Where there is a noise source nearby, the situation may be improved by taking a noise countermeasure such as keeping the noise source away or placing a shielding plate.
Error occurred during data writing.	<ul style="list-style-type: none"> • Data is inconsistent. 	<ul style="list-style-type: none"> • The inverter may recover by a reset operation, re-turning ON the power, or initialization operation. When the inverter recovered, an initialization must be executed. See "12.2.2 Initialization of Inverter".

E012 External trip error

When the inverter accepted a signal commanded by an external device or equipment, the inverter turns OFF its output. (Assigning 033[EXT] External fault function to any of the input terminal functions [CA-01] to [CA-11] and turning it ON will generate [E012].)



Occurrence ▶	Estimated cause(s) ▶	Exemplar measures to be taken
Error occurred unintentionally.	<ul style="list-style-type: none"> Terminal logics are reversed. Wiring is wrong. 	<ul style="list-style-type: none"> You need to check the state of operations related to external devices or external equipment, and re-examine the assignment of external trip terminal to the inverter input terminal, the setting of a/b contact, the external trip command via communication, etc. A/b contact of terminal can be changed by inverter setting.

E013 USP error

This error occurs if a RUN command has been input to the inverter when the power supply is turned ON. RUN command detection is carried out for 1 second after the power supply is turned ON.

(This is valid when input terminal function [USP] unattended start protection function is selected.)



Occurrence ▶	Estimated cause(s) ▶	Exemplar measures to be taken
Error occurred unintentionally.	<ul style="list-style-type: none"> RUN command was entered too early. 	<ul style="list-style-type: none"> Re-examination of the sequence to enter RUN command is required. You need to wait for 2 seconds or longer to enter RUN command after turning ON the power supply.
	<ul style="list-style-type: none"> RUN command isn't released. 	<ul style="list-style-type: none"> When turning on the power, the RUN command must be turned off.
	<ul style="list-style-type: none"> A RUN command from other than the input terminal was commanded to the inverter. 	<ul style="list-style-type: none"> When USP is enabled, RUN commands of the operator keypad and communication commands are treated as errors. After turning on the power, wait at least 2 seconds before entering an RUN command.

E014 Ground fault error



This is a function to protect the inverter by the detection of ground faults between the inverter output and the motor at power-on.

The function doesn't work when there is a voltage induced in the motor due to idling or when the inverter trips.

When the control circuit power (R0T0 or external 24VDC power supply) has been turned ON prior to the main circuit power R,S or T, the function is activated at the time the main circuit power is turned ON.

Setting the [bb-64] detect ground fault selection to 00 disables the ground fault function. Setting it to 01 enables the function.

Occurrence ▶	Estimated cause(s) ▶	Exemplar measures to be taken
Error occurred as the power supply was turned ON.	<ul style="list-style-type: none"> • Ground faults of wires or the motor • Motor insulation deterioration 	<ul style="list-style-type: none"> • Turn OFF the power, remove the wires connected to the motor, and then check the motor and the wires. A ground fault or insulation deterioration may have been occurred.. • Turning ON the power supply in a ground fault state results in a failure. Do not turn ON the power when you check the motor and motor wires.

E015 Power supply overvoltage error



This error occurs if high power supply voltage level is held for 100 seconds continuously while the inverter output is stopped when the [bb-61] "Power supply overvoltage selection" is set to 01.

This error occurs when the P-N voltage depending on the main power supply exceeds the voltage level set in [bb-62] "Power supply overvoltage level setting"

Occurrence ▶	Estimated cause(s) ▶	Exemplar measures to be taken
Error occurred after power was turned ON.	<ul style="list-style-type: none"> • Main power supply voltage is high. 	<ul style="list-style-type: none"> • Re-examination of the power supply environment is required.
Error occurred after long hours of use.	<ul style="list-style-type: none"> • Power supply has become unstable. 	<ul style="list-style-type: none"> • The power supply environment may have been changed due to facility replacement or the like. Re-examination of the power supply environment is required.

E016 Instantaneous power failure error

E016

At the time of an instantaneous power failure, the inverter turns OFF its output. If the power failure continues, the event is regarded as a normal power-off.

Decrease in the main power R, S, or T generates this error. Decrease in the voltage of control circuit power supply R0 or T0 doesn't generate the error if the J51 connector has been removed and the R0 and T0 are input via a separate system.

Occurrence ▶	Estimated cause(s) ▶	Exemplar measures to be taken
Error occurred after long hours of use.	• Power supply voltage decreased.	• If the power is turned OFF due to an external factor such as power failure, the inverter can be restarted by using the retry function when the power is restored.
	• There was a contact fault in circuit breaker.	• Failure of magnetic contactor or earth-leakage breaker may be the cause. Therefore, replaced them are required if necessary.
Error occurred with the start of operation.	• Power supply voltage decreased.	• If an instantaneous power failure hasn't occurred, insufficient capacity of power supply may be the cause. Re-examination of the power supply environment is required.

E019 Temperature detector error

E019

This error occurs if there is a problem in the temperature detector circuit such as disconnection.

Occurrence ▶	Estimated cause(s) ▶	Exemplar measures to be taken
Error occurred after use.	• The temperature detector circuit is disconnected or broken down.	• The temperature detector circuit is broken down. A repair is required.

E020 Cooling fan rotation speed reduction temperature error



If the temperature of inverter gets high due to deterioration of cooling ability resulted from decrease in fan rotation speed, the inverter turns OFF its output. Refer to E021 also.

Occurrence ▶	Estimated cause(s) ▶	Exemplar measures to be taken
Cooling fan stopped.	<ul style="list-style-type: none"> • A foreign object is stuck. • It is the end of cooling fan life. 	<ul style="list-style-type: none"> • If there is a foreign object stuck in the fan, the inverter may recover by removing it. • The cooling fan needs to be replaced.
The cooling fan is working.	<ul style="list-style-type: none"> • Cooling fan is approaching the end of its life. 	<ul style="list-style-type: none"> • The cooling ability has been deteriorated. The cooling fan needs to be replaced.

E021 Temperature error

When the temperature of inverter gets high, the inverter turns OFF its output.



Occurrence ▶	Estimated cause(s) ▶	Exemplar measures to be taken
Error occurred during operation.	<ul style="list-style-type: none"> • Carrier frequency is high. 	<ul style="list-style-type: none"> • The higher the carrier frequency is, the more the temperature inside the inverter tends to increase. Lower the carrier frequency setting.
	<ul style="list-style-type: none"> • There is clogging in the fin. 	<ul style="list-style-type: none"> • The cooling ability is deteriorated. Cleaning the fin may improve the situation.
	<ul style="list-style-type: none"> • Used in high temperature environment. • Cooling of the surroundings is insufficient.. 	<ul style="list-style-type: none"> • Enhancing the use environment or cooling environment may improve the situation.
	<ul style="list-style-type: none"> • The formal installation condition is not satisfied. 	<ul style="list-style-type: none"> • Improper installation of the inverter may results in the inverter failure. Install the inverter properly in accordance with the User's Guide.
Error occurred during stop.	<ul style="list-style-type: none"> • The temperature detector circuit broke down. 	<ul style="list-style-type: none"> • The temperature detector circuit is broken down if the error is generated consecutively even after a reset. A repair is required.

E024 Input open-phase error

E024

When [bb-65] "Input phase loss detection enable" is set to 01, when a missing phase is detected in input line, the inverter turns OFF its output.

Occurrence ▶	Estimated cause(s) ▶	Exemplar measures to be taken
Error occurred after power was turned ON.	<ul style="list-style-type: none"> An input line or the motor has a loose connection or is disconnected. Single-phase input is used. 	<ul style="list-style-type: none"> You need to turn OFF the power supply and check the input lines and the wiring condition of breaker. This error may also occur due to power supply voltage defect, contact defect, screw tightening failure, etc. For input lines, use three-phase connection.
Error occurred after long hours of use.	<ul style="list-style-type: none"> An input line or breaker has a loose connection or is disconnected. 	<ul style="list-style-type: none"> The situation may be improved by mending loose connections due to loosening of screws or the breaker problems.

E030 IGBT error

E030

At the time of an instantaneous overcurrent or the main element failure, the inverter turns OFF its output to protect the main element. Overcurrent error may be issued instead.

Occurrence ▶	Estimated cause(s) ▶	Exemplar measures to be taken
Error occurred right after the operation started.	<ul style="list-style-type: none"> A ground fault has occurred. Output line is short-circuited. Motor rotation is locked. Output element is broken down. 	<ul style="list-style-type: none"> After the power is turned OFF, you need to check the wires connected to the motor, motor disconnection, and the like. If the error occurs after removal of the motor wires, the inverter is broken down. It needs to be repaired. A large current may flow when the motor rotation is locked during operation. The cause needs to be removed. If output element is broken down, it needs to be repaired.
Error occurred right after power was turned ON.	<ul style="list-style-type: none"> Output element is broken down. 	<ul style="list-style-type: none"> If output element is broken down, it needs to be repaired.
Error occurred during operation.	<ul style="list-style-type: none"> Motor rotation is locked. 	<ul style="list-style-type: none"> A large current may flow when the motor rotation is locked during operation. The cause needs to be removed.

E034 Output open-phase error

E034

When the [bb-66] “Output phase loss detection enable” is set to 01, when a loose connection or disconnection of output line, disconnection inside the motor, etc. is detected, the inverter turns OFF its output. Detection of phase loss state is executed in the section between 5Hz to 100Hz.

Occurrence ▶	Estimated cause(s) ▶	Exemplar measures to be taken
Error occurred right after the operation started.	<ul style="list-style-type: none"> An output line or the motor has a loose connection or is disconnected. 	<ul style="list-style-type: none"> You need to turn OFF the power supply and check the output lines and the wiring condition of motor. This error can also occur due to motor insulation breakdown or screw tightening failure.
	<ul style="list-style-type: none"> Single-phase output is used. 	<ul style="list-style-type: none"> For output lines, use three-phase connection.
Error occurred after long hours of operation.	<ul style="list-style-type: none"> An output line or the motor has a loose connection or is disconnected. 	<ul style="list-style-type: none"> You need to turn OFF the power supply and check the output lines and the wiring condition of motor. If there is a loosened screw, the situation may be improved by re-tightening the screw.

E035 Thermistor error

E035

If an abnormal temperature is observed during detection of resistor level change in an external thermistor, the inverter turns OFF its output. (This is valid when the [Cb-40] “Thermistor type selection” is not disable.)

Occurrence ▶	Estimated cause(s) ▶	Exemplar measures to be taken
Motor is heated.	<ul style="list-style-type: none"> The motor hasn't been cooled sufficiently. 	<ul style="list-style-type: none"> The cooling environment needs to be improved.
	<ul style="list-style-type: none"> Heavy load has been applied for a long time. 	<ul style="list-style-type: none"> The motor's driving environment needs to be re-examined.
Motor is not heated.	<ul style="list-style-type: none"> Inadequate thermistor function setting 	<ul style="list-style-type: none"> Re-examination of the thermistor function setting may improve the situation.
	<ul style="list-style-type: none"> The thermistor is broken down. 	<ul style="list-style-type: none"> The thermistor needs to be repaired.
	<ul style="list-style-type: none"> Malfunction due to noise 	<ul style="list-style-type: none"> The situation may be improved by taking a noise countermeasure such as wiring separation.

E036 Brake error

This error occurs when the inverter can not detect whether the brake check signal is ON or OFF during waiting time after the inverter has output a brake releasing signal.

(When brake function is enabled.)

E036

Occurrence ▶	Estimated cause(s) ▶	Exemplar measures to be taken
Error occurred after operation.	<ul style="list-style-type: none"> • Disconnection of signal line. • Brake function setting 	<ul style="list-style-type: none"> • Check the wiring of [BOK] "Answer back from Brake" signal and whether the signal is ON or OFF. • The situation may be improved by re-examination of brake check waiting time or input terminal logics according to the sequence of the signal.

E038 Low-speed range overload error

This error occurs to protect the main element if the inverter has output at a low frequency of 0.2Hz or below.

When such a low frequency is detected by the built-in electronic thermal function, the inverter turns OFF its output.

E038

Occurrence ▶	Estimated cause(s) ▶	Exemplar measures to be taken
Error occurred during output at low speed.	<ul style="list-style-type: none"> • The motor load is heavy. 	<ul style="list-style-type: none"> • Load at low-speed range needs to be reduced. If the error occurs frequently, you need to select an inverter with a capacity large enough for the motor.

E039 Controller (inverter) overload error



The built-in electronic thermal function monitors the output current of the inverter (controller) and when inverter overload is detected, the inverter turns OFF its output. If a controller(inverter) overload error occurs, reset input is not accepted for 10 seconds. Wait for a while before resetting. There is no user parameter for controller (inverter) overload protection. Also, regardless the setting of the [Ub-03] Load type selection, ND rated derating is applied. Refer to “20.4 Current Derating” for details of derating. When this error occurs, take the following actions.

Occurrence ▶	Estimated cause(s) ▶	Exemplar measures to be taken
Error occurred after a fixed period of operation. (Or accelerating)	<ul style="list-style-type: none"> • Operation under heavy load condition has continued. 	<ul style="list-style-type: none"> • Re-examination of operation condition or correction of load condition may improve the situation.
	<ul style="list-style-type: none"> • With the change of the Load type selection (ND/LD/VLD), carrier frequency, it was overloaded by current derating. 	<ul style="list-style-type: none"> • It may be improved by reducing the carrier frequency setting, reviewing overload / overcurrent limit or other operating conditions, or improving the load status.
Error occurred during acceleration.	<ul style="list-style-type: none"> • Insufficient acceleration torque • Load inertia is large. • Friction torque is large. 	<ul style="list-style-type: none"> • Setting longer acceleration time in [FA-10] can ease the insufficient acceleration torque. • When acceleration torque is required, the situation may be improved by adjusting the [Hb141] manual torque boost value, or by operating the inverter and making adjustments with control method in [AA121]. • Re-examination of load condition may improve the situation.
	<ul style="list-style-type: none"> • A function to suppress overcurrent is at work. 	<ul style="list-style-type: none"> • A factor for overcurrent may have been occurred. Re-examination of acceleration time or load condition is required.
Error occurred during deceleration.	<ul style="list-style-type: none"> • Load inertia is large. 	<ul style="list-style-type: none"> • Insufficient rotation regeneration torque can be eased by setting longer deceleration time in [FA-12]. • When regenerative torque is required, the situation may be improved by adjusting the [Hb141] manual torque boost value, or by operating the inverter and adjusting with control method in [AA121]. • Re-examination of load condition may improve the situation.
	<ul style="list-style-type: none"> • A function to suppress overvoltage is at work. 	<ul style="list-style-type: none"> • Current may increase as a result of suppressing overvoltage. Re-examination of deceleration time or load condition is required.
Error occurred after long hours of use.	<ul style="list-style-type: none"> • System environment changes 	<ul style="list-style-type: none"> • The situation may be improved by reducing the motor load, or performing a system maintenance (e.g., cleaning the fan to be driven and removing clogging in the duct).
	<ul style="list-style-type: none"> • Aging deterioration 	<ul style="list-style-type: none"> • If the issue is not solved by reduction of the load and system maintenance, aging deterioration of a life-limited component may be the cause. A repair is required.

E040 Operator keypad disconnection error



The inverter displays this error when timeout occurs because of a malfunction due to noises, loose connection or disconnection of circuit for communication with the operator keypad(VOP).

This error function can be enabled and disabled by setting of the [UA-20] “action selection at keypad disconnection”.

Occurrence ▶	Estimated cause(s) ▶	Exemplar measures to be taken
Error occurred after communication is started.	<ul style="list-style-type: none"> • Loose connection • Disconnection 	<ul style="list-style-type: none"> • Check the wiring to see whether the connection is properly made.
	<ul style="list-style-type: none"> • Noise is mixed. 	<ul style="list-style-type: none"> • The situation may be improved by taking a noise countermeasure such as wiring separation.

E041 RS485 communication error



The inverter displays this error when RS485 communication timeout occurs because of a malfunction due to noises, loose wire connection or wiring disconnection, etc.

This error function can be enabled and disabled by setting of the [CF-05] “RS485 communication error selection”.

This error may occur even if the communication settings with the connected control device do not match (in this case, the connection is not normally established and an error occurs in the control device). Check [CF-01] to [CF-08].

Occurrence ▶	Estimated cause(s) ▶	Exemplar measures to be taken
Error occurred after communication is started.	<ul style="list-style-type: none"> • Loose connection • Disconnection 	<ul style="list-style-type: none"> • Check the wiring to see whether or not the connection is properly made.
	<ul style="list-style-type: none"> • Noise is mixed. 	<ul style="list-style-type: none"> • The situation may be improved by taking a noise countermeasure such as wiring separation.

E042 RTC error

The error is generated if the data of RTC incorporated in the operator keypad(VOP) is returned to the initial data.



Occurrence ▶	Estimated cause(s) ▶	Exemplar measures to be taken
Error occurred at power-on.	<ul style="list-style-type: none"> A battery in the operator runs out. 	<ul style="list-style-type: none"> Replacement of the battery and setting of the date solve the issue. The error occurs when the power supply is turned ON with a dead battery.

E043 EzSQ invalid instruction error

This error is output when an invalid instruction is detected while executing the EzSQ program which is downloaded to the inverter.

The error is also output if the EzSQ program is executed when it is not downloaded.



Occurrence ▶	Estimated cause(s) ▶	Exemplar measures to be taken
Error occurred when the EzSQ program is executed.	<ul style="list-style-type: none"> Downloading error due to noise. 	<ul style="list-style-type: none"> There is a possibility of the EzSQ program downloading error and if there is a noise source nearby, the situation may be improved by taking a noise countermeasure such as keeping the noise source away.
	<ul style="list-style-type: none"> EzSQ program hasn't been downloaded. 	<ul style="list-style-type: none"> EzSQ program needs to be downloaded in the factory default setting condition and after initialization.

E044 EzSQ nesting count error



This error is output when the nesting frequency of a subroutine, "for" statement, "next" statement, etc. on a program exceeds 8 times while the programming function EzSQ is used.

Occurrence ▶	Estimated cause(s) ▶	Exemplar measures to be taken
Error occurred when the program was put into action.	<ul style="list-style-type: none"> • Program structure is too complicated. 	<ul style="list-style-type: none"> • The program has deep nesting of a subroutine, "for" statement, "next" statement, etc., with its nesting frequency exceeding 8 times. Improvement of the program structure is required.

E045 EzSQ execution error



During operation of a program which is downloaded to the inverter while the programming function EzSQ is used, if execution of the program is turned OFF due to an error, the inverter generates E045 error.

Occurrence ▶	Estimated cause(s) ▶	Exemplar measures to be taken
Error occurred when the program was put into action.	<ul style="list-style-type: none"> • Program flow is inadequate. 	<ul style="list-style-type: none"> • This error is output if there is no nest starting statement such as "for" at the point when "goto" statement refers to, or if a nest ending statement such as "next" precedes the nest starting statement. Check the structure of "for" statement and "next" statement and make amendments as needed.
	<ul style="list-style-type: none"> • There is a problem in the data. 	<ul style="list-style-type: none"> • There may be an overflow, underflow, or division by zero in four arithmetic operations. Check the result of operations and amend the operations as needed.
		<ul style="list-style-type: none"> • This error is output if a non-existing parameter is referred to or a setting is made beyond the setting range in "chg param" or "mon param" instruction. Check the content of instruction and make amendments as needed.

E050 to E059

EzSQ user-assigned error 0 to 9

**E050 to
E059**

The inverter generates these errors when the corresponding user-assigned tripping programs are executed during operation of a program which is downloaded to the inverter while the programming function EzSQ is used.

Occurrence ▶	Estimated cause(s) ▶	Exemplar measures to be taken
Error occurred when the program was put into action.	<ul style="list-style-type: none"> The program has an error instruction. 	<ul style="list-style-type: none"> If a user-assigned error occurs unintentionally, check the content of trip instruction of the program and make amendments as needed.

E060 to E069

Option 1 errors 0 to 9

**E060 to
E069**

Errors occurring in an option mounted in the option slot 1 (to the observer's left) are detected.
For details, refer to the instruction manual provided together with the option mounted.

Occurrence ▶	Estimated cause(s) ▶	Exemplar measures to be taken
Error occurred when an option is mounted.	<ul style="list-style-type: none"> The option isn't securely mounted. 	<ul style="list-style-type: none"> The option may not be securely mounted. Check the mounting state.
	<ul style="list-style-type: none"> The option is used in the wrong way. 	<ul style="list-style-type: none"> The type of error varies depending on options. For details, refer to the instruction manuals provided together with the respective options.

E070 to E079

Option 2 error 0 to 9

Errors occurring in an option mounted in the option slot 2 (to the observer's center) are detected.

For details, refer to the instruction manual provided together with the option mounted.

**E070 to
E079**

Occurrence ▶	Estimated cause(s) ▶	Exemplar measures to be taken
Error occurred when an option is mounted.	<ul style="list-style-type: none"> The option isn't securely mounted. The option is used in the wrong way. 	<ul style="list-style-type: none"> The option may not be securely mounted. Check the mounting state. The type of error varies depending on options. For details, refer to the instruction manuals provided together with the respective options.

E080 to E089

Option 3 error 0 to 9

Errors occurring in an option mounted in the option slot 3 (to the observer's right) are detected.

For details, refer to the instruction manual provided together with the option mounted.

**E080 to
E089**

Occurrence ▶	Estimated cause(s) ▶	Exemplar measures to be taken
Error occurred when an option is mounted.	<ul style="list-style-type: none"> The option isn't securely mounted. The option is used in the wrong way. 	<ul style="list-style-type: none"> The option may not be securely mounted. Check the mounting state. The type of error varies depending on options. For details, refer to the instruction manuals provided together with the respective options.

E090 to E093

STO shutoff error, STO internal error,
STO path1 error, STO path2 error

E094 to E097

FS option internal error,
FS option path1 error,
FS option path2 error,
FS option communication error

**E090 to
E096**

This error is output when there is a problem in functional safety circuit path.

For details of E090 to E093, refer to the separate-volume "Functional Safety Guide" (NT2512*X).

For details of E094 to E097, refer to the User's Guide (NT2582*X) bundled with the P1-FS option

Occurrence ▶	Estimated cause(s) ▶	Exemplar measures to be taken
The safety function is used.	<ul style="list-style-type: none"> The safety function system has problems. 	<ul style="list-style-type: none"> Refer to the separate-volume "P1 Safety function Guide"(NT2512*X) or "P1-FS Functional Safety Option Safety Function Guide"(NT2582*X).

E100 Encoder disconnection error

This is an error related to feedback options.
For E100 (encoder disconnection error), refer to the "P1-FB Encoder Feedback option User's Guide" (NT253*X).

E100

E104 Position control range error



This error occurs when the current position counter exceeds the position control range set in [AE-52] "Position control setting range (forward)" and [AE-54] "Position control setting range (reverse)".

Related pages found herein: 12-17-26

Occurrence ▶	Estimated cause(s) ▶	Exemplar measures to be taken
Error occurred during operation.	<ul style="list-style-type: none"> • Recheck the setting of electronic gear. 	<ul style="list-style-type: none"> • Re-examination of operation condition or correction of load condition may improve the situation.
	<ul style="list-style-type: none"> • A slip occurs due to improper encoder setting. 	<ul style="list-style-type: none"> • Check the encoder mounting state. If any, re-examine factors for slipping.
	<ul style="list-style-type: none"> • Improper encoder setting 	<ul style="list-style-type: none"> • Check the setting of encoder constant and the like.
	<ul style="list-style-type: none"> • Improper electronic gear setting 	<ul style="list-style-type: none"> • Recheck the setting of electronic gear.

E105 Speed deviation error



When the deviation between the frequency reference and the feedback speed exceeds the setting of the [bb-83] "Speed deviation error detection level", the inverter judges it as an error. If 01(Error) is specified for [bb-82] "Speed deviation error mode selection", the inverter turns ON the output terminal function 041 [DSE] with a speed deviation error, this error is occurred.

Related pages found herein: 12-16-11

Occurrence ▶	Estimated cause(s) ▶	Exemplar measures to be taken
Error occurred during operation.	<ul style="list-style-type: none"> • Recheck the setting of electronic gear. 	<ul style="list-style-type: none"> • Re-examination of operation condition or correction of load condition may improve the situation.
	<ul style="list-style-type: none"> • A slip occurs due to improper encoder setting. 	<ul style="list-style-type: none"> • Check the encoder mounting state. If any, re-examine factors for slipping.
	<ul style="list-style-type: none"> • Improper encoder setting 	<ul style="list-style-type: none"> • Check the setting of encoder constant and the like.
	<ul style="list-style-type: none"> • Improper electronic gear setting 	<ul style="list-style-type: none"> • Recheck the setting of electronic gear.

E106 Position deviation error



When the deviation of the position feedback exceeds the [bb-86] “Position deviation error detection level” and the [bb-87] “Position deviation error detection time” passes, it is determined to be abnormal. When the [bb-85] “Position deviation error mode selection” set to 01, the output terminal [PDD] is turned ON and this error is occurred.

Related pages found herein: 12-17-18

Occurrence ▶	Estimated cause(s) ▶	Exemplar measures to be taken
Error occurred during operation.	<ul style="list-style-type: none"> • Recheck the setting of electronic gear. 	<ul style="list-style-type: none"> • Re-examination of operation condition or correction of load condition may improve the situation.
	<ul style="list-style-type: none"> • A slip occurs due to improper encoder setting. 	<ul style="list-style-type: none"> • Check the encoder mounting state. If any, re-examine factors for slipping.
	<ul style="list-style-type: none"> • Improper encoder setting 	<ul style="list-style-type: none"> • Check the setting of encoder constant and the like.
	<ul style="list-style-type: none"> • Improper electronic gear setting 	<ul style="list-style-type: none"> • Recheck the setting of electronic gear.

E107 Over-speed error



When the speed has exceeded [bb-80] “Over-speed detection level” and [bb-81] “Over-speed detection time”, this error is occurred.

Related pages found herein: 12-16-12

Occurrence ▶	Estimated cause(s) ▶	Exemplar measures to be taken
Error occurred during operation.	<ul style="list-style-type: none"> • Recheck the setting of electronic gear. 	<ul style="list-style-type: none"> • Re-examination of operation condition or correction of load condition may improve the situation.
	<ul style="list-style-type: none"> • Improper encoder setting 	<ul style="list-style-type: none"> • Check the setting of encoder constant and the like.
	<ul style="list-style-type: none"> • Improper electronic gear setting 	<ul style="list-style-type: none"> • Recheck the setting of electronic gear.

E110 Contactor error

When an error occurs in the contactor sequence, the output is turned OFF.

Related pages found herein: 12-17-10



Occurrence ▶	Estimated cause(s) ▶	Exemplar measures to be taken
[COK] was not turned ON within the contactor check time at start-up.	<ul style="list-style-type: none"> • Wiring defect • Contactor response defect 	<ul style="list-style-type: none"> • Check the setting and wiring of intelligent input. • Check the operation of contactor including its response time.
[COK] was not turned OFF within the contactor check time at stop.	<ul style="list-style-type: none"> • Wiring defect • Contactor response defect 	<ul style="list-style-type: none"> • Check the setting and wiring of intelligent input. • Check the operation of contactor including its response time.

E112 Feedback option connection error

This is an error related to feedback options.
 For E112 (FB option connection error), see the P1-FB user's guide.



E120 PID start error



When [AH-75] "PID soft start function enable" and [AH-81] "PID soft start error detection enable" are set to 01 and PID operation is performed, this error occurs when the PID feedback value does not reach [AH-82] "PID soft start error detection level" after the set time of [AH-80] "PID soft start time" has elapsed.

Occurrence ▶	Estimated cause(s) ▶	Exemplar measures to be taken
Error occurred during operation.	<ul style="list-style-type: none"> • PID set-point may be too low. 	<ul style="list-style-type: none"> • Re-examination of the [AH-76] "PID soft start target level" setting may improve the situation.
	<ul style="list-style-type: none"> • Disconnection of signal line. 	<ul style="list-style-type: none"> • PID feedback may not be entered properly. Check the wiring and [db-44] "PID1 feedback value monitor (after calculation)".

18.5 Troubleshooting for Warning Functions Related Error

18.5.1 Checking the Warning Display

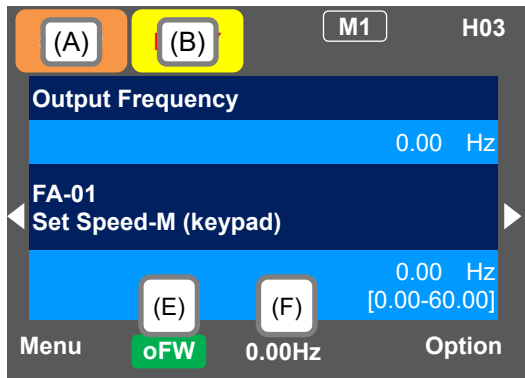

Display (A) Main Operation status display

No.	Indication	Description
A1	RUN FW	Displayed during forward rotation. There are some parameters that cannot be changed while the inverter is in running.
A2	RUN RV	Displayed during reverse rotation. There are some parameters that cannot be changed while the inverter is in running.
A3	RUN 0Hz	The inverter is in running at 0Hz output. This is also displayed by DB, FOC, and SON functions. There are some parameters that cannot be changed while the inverter is in running.
A4	TRIP	Displayed during trip after the occurrence of error. For errors that cannot be canceled, perform reset operation to cancel. -> 18.3.1 Checking Trip Information.
A5	WARN	Displayed when setting inconsistency occurs. It is cleared when the inconsistency is resolved. -> 18.5.2 Checking Setting Inconsistencies.
A6	STOP	This is the stop display when the RUN command is being input but the output to the motor is shut off by a forced stop due to some function: <ul style="list-style-type: none"> The RUN command was input when the frequency reference value is 0 Hz; The inverter stopped by the Keypad STOP key when the RUN command is other than the Keypad; The inverter stopped due to the output shutoff function such as [RS], [FRS] or etc., when the RUN command is other than the Keypad; The inverter stopped by the Instantaneous power failure non-stop function. At this time, the RUN LED blinks.
A7	STOP	This is the stop display when there is no run command. <ul style="list-style-type: none"> If the run command is the keypad RUN key, the inverter immediately enters this stop when the shutoff terminal functions are turned on.

(Tips)

- A6: If STOP (red),
=>When the display (F) is 0.00 Hz, the reference frequency is 0.00Hz. Make sure that the intended frequency reference is entered.
- =>For example, the inverter is stopped by keypad STOP key while running by the input terminal [FW], the [FW] terminal must be turned off and then on again to start operation again.
- =>The inverter cannot be driven if the output shutoff functions such as [RS] reset, [FRS] free-run, or STO terminal are ON.

Display (B) Warning status display

No.	Indication	Description
B1	LIM	While: <ul style="list-style-type: none"> Overload restriction; Torque limiting; Overcurrent suppression; Overvoltage suppression; Upper or lower frequency limited; Jump frequency limited; minimum frequency limited. Details can be confirmed in [dC-37].
B2	ALT	This is displayed with the following functions: <ul style="list-style-type: none"> Overload warning; Motor thermal warning; Inverter thermal warning; Motor heat warning. Details can be confirmed in [dC-38].
B3	RETRY	While waiting for retry or restart functions. Details can be confirmed in [dC-39].
B4	NRDY	While inverter is in a state unfit to operate, even if a RUN command is issued. <ul style="list-style-type: none"> Main power undervoltage; Operating only with 24 VDC supply; Resetting; Run command is not possible when the input terminal 101[REN](RUN enable) is assigned and it is OFF. Details can be confirmed in [dC-40].
B5	FAN	Cooling-fan life warning is issued. Also, the output terminal 030 [WAF] turned ON.
B6	C	Capacitor life warning is issued. Also, the output terminal 029[WAC] turned ON.
B7	F/C	When both Capacitor and Cooling-fan life warnings are issued.
B8	(None)	Different statuses from those shown above.

(Tips)

- LIM and ALT are indicated when current and internal voltage has risen. Review things such as the load if this error happens too often.
- Above icons are indicated when the cooling-fan and the electrolytic capacitors on the board lifespan has reached to the end.
- When [multi monitor],[While screen] or [Huge monitor], press the Up key (▲) to see the details of the warning.

Display (E) Keypad's RUN key function

No.	Indication	Description
E1	oFW	Forward operation from panel's RUN key.
E2	oRV	Reverse operation from panel's RUN key.
E3	>FW	By 023 [F-OP] Force operation or the keypad VOP or etc. functions, Keypad RUN key is forcibly enabled (>FW=Forward, >RV=Reverse)
E4	>RV	
E5	(None)	Different operation (other than RUN).

(Tips)

- When the keypad RUN key is enabled, E1 to E4 are displayed on (E).
- When checking the run command source or running from the keypad RUN key, first review the [AA111] RUN command input source selection. Alternatively, check the [dC-10] RUN command input source monitor.
- When "17: Remote mode switching" in the system settings is enabled, if the F1 key is held down for 1 second or longer on the home screen, the frequency reference source and RUN command source are forcibly switched to the keypad.

■ (STOP in red) appears.



• (STOP in red) appears.



• See below.

Occurrence ▶	Estimated cause(s) ▶	Exemplar measures to be taken
RUN key on the keypad was pressed.	If LIM icon is lit, the command is below the minimum frequency and the following reasons are conceivable. <ul style="list-style-type: none"> • RUN command is entered but not frequency reference. • Frequency reference source selection is wrong. 	<ul style="list-style-type: none"> • Check that [FA-01] "Main speed reference setting or monitor" is not set to 0.00Hz. • Check whether the command is entered from the command source indicated on the right of the [FA-01] on the operator keypad. • Check [AA101] "Main speed input source selection, 1st-motor"
[FW] terminal was turned ON.		
RUN command was entered.		
After STOP key on keypad is pressed, inverter doesn't operate with RUN key.	<ul style="list-style-type: none"> • STOP key on the operation keypad was pressed when the RUN command had been entered from a source other than the operation keypad. 	<ul style="list-style-type: none"> • Cancel the command entered from the RUN command source.
Instantaneous power failure occurred.	<ul style="list-style-type: none"> • The inverter stopped by the [bA-30] instantaneous power failure non-stop function. 	<ul style="list-style-type: none"> • To start operation, turn off the RUN command entered from the RUN command source and turn on again.

■ (WARN) appears.



• (WARN) appears.



• See below.

Occurrence ▶	Estimated cause(s) ▶	Exemplar measures to be taken
A setting was configured.	<ul style="list-style-type: none"> • There is an inconsistency in the parameter setting 	<ul style="list-style-type: none"> • Refer to 18.5.2 "Checking Setting Inconsistencies".

Icon 2 LIM monitor



- The LIM icon is shown on the display.



- When LIM is shown, the inverter is in the following condition(s).
- The LIM status can be confirmed by pressing the up key while the [Multi monitor] (3-line screen) is displayed or by referring to the [dC-37].

Occurrence ▶	Estimated cause(s) ▶	Exemplar measures to be taken
Output current was high, and [dC-37] LIM was set to 01.	<ul style="list-style-type: none"> • [bA120] overcurrent suppression function was enabled and the current increased due to the load or other factors. • The current was increased by the high ratio of motor rotation during DC braking that was caused by the selection of the [DB] terminal or the DC braking selection [AF101]. • [FA-10] acceleration time is too short. 	<ul style="list-style-type: none"> • Remove the factor for the increased load. (E.g., by cleaning a clogged channel, re-examining the load) • Reduce the DC braking force in [AF105] or [AF108]. • For stopping, set a longer time to the DC braking active time at stop [AF106]. • For retry operation at the start, set longer delay time according to the factors. [bb-26] [bb-29] [bb-31] • Make the acceleration time longer in [FA-10].
Output current was high, and [dC-37] LIM was set to 02.	<ul style="list-style-type: none"> • [bA122] overload limit function or similar function was enabled and the current increased due to the load or other factors. • [bA122] overload limit function or similar function was enabled and [FA-10] acceleration time was too short. 	<ul style="list-style-type: none"> • Remove the factor for the increased load. (E.g., by cleaning a clogged channel, re-examining the load) • Make the acceleration time longer in [FA-10].
Error occurred during deceleration. [dC-37] LIM was set to 03.	<ul style="list-style-type: none"> • [bA140] overvoltage suppression function was enabled and P-N voltage increased due to regenerative load or the like. • [bA122] overload limit function or similar function was enabled and [FA-12] deceleration time was too short. 	<ul style="list-style-type: none"> • Remove the factor for the increased regenerative load. (E.g., by re-examining the state of the motor being rotated by external force, and by re-examining the load.) • Make the deceleration time longer in [FA-12].
Error occurred during sudden acceleration. [dC-37] LIM was set to 03.	<ul style="list-style-type: none"> • [bA140] overvoltage suppression function was enabled and P-N voltage increased due to regenerative load or the like. 	<ul style="list-style-type: none"> • Remove the factor for the increased regenerative load. (E.g., by re-examining the state of the motor being rotated by external force, and by re-examining the load)
Output current was high, and [dC-37] LIM was set to 04.	<ul style="list-style-type: none"> • [bA110] torque limit function or similar function was enabled and the current increased due to the load or other factors. • [bA110] torque limit function or similar function was enabled and [FA-10] acceleration time was too short. 	<ul style="list-style-type: none"> • Remove the factor for the increased load. (E.g., by cleaning a clogged channel, re-examining the load) • Make the acceleration time longer in [FA-10].
Error occurred during operation. [dC-37] LIM was set to 05.	<ul style="list-style-type: none"> • The limiting is performed properly due to the settings of the Upper frequency limit [bA102], the Lower frequency limit [bA103], and the Jump frequency ([AG101] or etc.). 	<ul style="list-style-type: none"> • Re-examine the settings of the upper/lower limiter or jump frequencies if necessary.
Error occurred during operation. [dC-37] LIM was set to 06.	<ul style="list-style-type: none"> • The frequency reference at below the minimum frequency [Hb130] has been input. 	<ul style="list-style-type: none"> • Set the frequency reference at the minimum frequency or higher in [FA-01].

■ Icon 2 ALT monitor



- The ALT icon is shown on the display.



- When ALT is shown, the inverter is in the following condition(s).
- The ALT status can be confirmed by pressing the up key while the [Multi monitor] (3-line screen) is displayed or by referring to the [dC-38].

Occurrence ▶	Estimated cause(s) ▶	Exemplar measures to be taken
Output current was high, and [dC-38] ALT was set to 01.	<ul style="list-style-type: none"> • The current increased due to load or other factors, exceeding the overload warning levels such as the parameter [CE106]. 	<ul style="list-style-type: none"> • Remove the factor for the increased load. (E.g., by cleaning a clogged channel) • Enable [bA122] overload limit function or similar function.
Output current was high, and [dC-38] ALT was set to 02.	<ul style="list-style-type: none"> • The electronic thermal function of motor was activated due to increase in current and the load exceeded the [CE-30] "Electronic thermal warning level (Motor)". 	<ul style="list-style-type: none"> • Remove the factor for the increased load. (E.g., by cleaning a clogged channel) • Re-examine the electric thermal settings of the [bC110] and others.
Output current was high, and [dC-38] ALT was set to 03.	<ul style="list-style-type: none"> • The electronic thermal function of inverter was activated due to increase in current and the load exceeded the [CE-31] "Electronic thermal warning level (Inverter)". 	<ul style="list-style-type: none"> • Remove the factor for the increased load. (E.g., by cleaning a clogged channel)

■ Icon 2 RETRY monitor



- The RETRY icon is shown on the display.



- When RETRY is shown, the inverter is in the following condition(s).
- The RETRY status can be confirmed by pressing the up key while the [Multi monitor] (3-line screen) is displayed or by referring to the [dC-39].

Occurrence ▶	Estimated cause(s) ▶	Exemplar measures to be taken
Output was turned OFF and [dC-39] RETRY was set to 01.	<ul style="list-style-type: none"> • The inverter is in the waiting mode after a trip retry operation due to increased current or P-N voltage fluctuation. 	<ul style="list-style-type: none"> • If the wait time is long, set the following retry wait time settings shorter. [bb-26] [bb-29] [bb-31] • If this error occurs continuously, set the following retry wait time settings longer. [bb-26] [bb-29] [bb-31]
Output was turned OFF and [dC-39] RETRY was set to 02.	<ul style="list-style-type: none"> • The inverter is in the waiting mode before restart after power-off by [RS], [FRS], or [CS] terminal. 	<ul style="list-style-type: none"> • If the wait time is long, set the following retry wait time setting shorter. [bb-26]

Icon 2 NRDY monitor



- The NRDY icon is shown on the display.



- When NRDY is shown, the inverter is in the following condition(s).
- The NRDY status can be confirmed by pressing the up key while the [Multi monitor] (3-line screen) is displayed or by referring to the [dC-40].

Occurrence ▶	Estimated cause(s) ▶	Exemplar measures to be taken
TRIP display was shown and [dC-40] NRDY was set to 01.	<ul style="list-style-type: none"> There was an error factor, which caused the inverter to trip. 	<ul style="list-style-type: none"> Remove the error factor. Consult this chapter.
The CTRL icon was shown and [dC-40] NRDY was set to 02.	<ul style="list-style-type: none"> The control power supply (R0, T0) has been input, whereas the main circuit power supply R-S-T hasn't been input. 	<ul style="list-style-type: none"> Check the input of main circuit power supply and examine the breaker, wiring, and so on.
The 24V icon was shown and [dC-40] NRDY was set to 02.	<ul style="list-style-type: none"> Only 24V has been input to the backup power supply P+-P-. 	<ul style="list-style-type: none"> Check the input of main circuit power supply and the control power supply, and examine the breaker, wiring, and so on.
[dC-40] NRDY was set to 03.	<ul style="list-style-type: none"> [RS] terminal is ON and the inverter is under reset operation. 	<ul style="list-style-type: none"> Check the wiring and operation state of [RS] terminal.
[dC-40] NRDY was set to 04.	<ul style="list-style-type: none"> The STO circuit is turned OFF or broken. 	<ul style="list-style-type: none"> Check ST1/ST2 terminals.
[dC-40] NRDY was set to 05.	<ul style="list-style-type: none"> The inverter is checking the internal circuit, operator keypad, options, etc. 	<ul style="list-style-type: none"> If this error is not released, check the operator keypad for contact failure or other problem.
[dC-40] NRDY was set to 06.	<ul style="list-style-type: none"> There is an inconsistency in the setting. 	<ul style="list-style-type: none"> [CA-90] is not 02 and [AA121] is 4, 5, 6, 7 or 10 (Control with encoder using P1-FB), but the option P1-FB is not attached. Refer to "18.5.2 Checking Setting Inconsistencies".
[dC-40] NRDY was set to 07.	<ul style="list-style-type: none"> There is a sequence operation problem in the brake control. 	<ul style="list-style-type: none"> Check the brake control settings such as the [AF130] and the signal behavior.
[dC-40] NRDY was set to 08.	<ul style="list-style-type: none"> [FRS] terminal or [CS] terminal was turned ON. [FRS] or [CS] command was entered from the communication. 	<ul style="list-style-type: none"> Check the signal operation of input terminal for [FRS] or [CS].
[dC-40] NRDY was set to 09.	<ul style="list-style-type: none"> RUN command isn't permitted. Forced stop is being issued. (Deceleration stop behavior) 	<ul style="list-style-type: none"> The [REN] terminal has been assigned and is turned OFF. STOP key was pressed when commands had been entered from a source other than the operation keypad.

18.5.2 Checking Setting Inconsistencies



- A warning was generated. You want to identify the cause and troubleshoot the warning.



- You need to take a measure according to the warning number and the type of warning. Refer to the table below.
- The induction motor (IM) control and synchronous motor (permanent magnetic motor) (SM (PMM)) control can be switched in [AA121]. After a warning occurs, the following warning numbers can be monitored with the [dE-50] warning monitor.

Occurrence ▶	Estimated cause(s) ▶	Exemplar measures to be taken
Warning 102	(Max.frequency,1st-motor) < (Upper frequency limit,1st-motor) IM: [Hb105] < [bA102] SM (PMM): [Hd105] < [bA102]	<ul style="list-style-type: none"> • Increase the Max. frequency [Hb105]/[Hd105]. • Decrease the Upper frequency limit,1st-motor [bA102].
Warning 103	(Max. frequency, 1st-motor) < (Lower frequency limit, 1st-motor) IM: [Hb105] < [bA103] SM (PMM): [Hd105] < [bA103]	<ul style="list-style-type: none"> • Increase the Max. frequency [Hb105]/[Hd105]. • Decrease the Lower frequency limit, 1st-motor [bA103].
Warning 106	(Max. frequency, 1st-motor) < (Multi-speed 0 setting,1st-motor) IM: [Hb105] < [Ab110] SM (PMM): [Hd105] < [Ab110]	<ul style="list-style-type: none"> • Increase the Max. frequency [Hb105]/[Hd105]. • Decrease the Multi-speed 0 setting,1st-motor [Ab110].
Warning 107	(Max. frequency,1st-motor) < (Sub speed setting,1st-motor) IM: [Hb105] < [AA104] SM (PMM): [Hd105] < [AA104]	<ul style="list-style-type: none"> • Increase the Max. frequency [Hb105]/[Hd105]. • Decrease the Sub speed setting,1st-motor [AA104].
Warning 202	(Max.frequency,2nd-motor) < (Upper frequency limit,2nd-motor) IM: [Hb205] < [bA202] SM (PMM): [Hd205] < [bA202]	<ul style="list-style-type: none"> • Increase the Max. frequency [Hb205]/[Hd205]. • Decrease the Upper frequency limit,2nd-motor [bA202].
Warning 203	(Max.frequency,2nd-motor) < (Lower frequency limit, 2nd-motor) IM: [Hb205] < [bA203] SM (PMM): [Hd205] < [bA203]	<ul style="list-style-type: none"> • Increase the Max. frequency [Hb205]/[Hd205]. • Decrease the Lower frequency limit, 2nd-motor [bA203].
Warning 206	(Max.frequency,2nd-motor) < (Multi-speed 0 setting,2nd-motor) IM: [Hb205] < [Ab210] SM (PMM): [Hd205] < [Ab210]	<ul style="list-style-type: none"> • Increase the Max. frequency [Hb205]/[Hd205]. • Decrease the Multi-speed 0 setting,2nd-motor [Ab210].
Warning 207	(Max. frequency,2nd-motor) < (Sub speed setting,2nd-motor) IM: [Hb205] < [AA204] SM (PMM): [Hd205] < [AA204]	<ul style="list-style-type: none"> • Increase the Max. frequency [Hb205]/[Hd205]. • Decrease the Sub speed setting,2nd-motor [AA204].

18.5.3 Checking Display Messages



- A message was appeared on the operator keypad VOP. You want to know the meaning of error.



- A message appears in an event like communication error, insufficient voltage, or result of auto-tuning.
- Even if there is an error, the screen can be changed using the ● key. However, the cause of the error needs to be improved separately.
(● is the [SEL] key in the center of the arrow keys.)

Message▶	Estimated cause(s)▶	Exemplar measures to be taken
Warning xxxxxxxxxxxxxx Press ● key	<ul style="list-style-type: none"> • Warning of setting inconsistency was generated. There is inconsistency of setting shown in the warning message. 	<ul style="list-style-type: none"> • The warning will be canceled by amending the indicated parameter setting.
Static tuning End!! xxxxxxxxxxxxxx Press ● key	<ul style="list-style-type: none"> • Non-revolving auto-tuning process is finished. 	<ul style="list-style-type: none"> • See "12.3.3 Auto-Tuning of Motor".
Rotating tuning End!! xxxxxxxxxxxxxx Press ● key	<ul style="list-style-type: none"> • Revolving auto-tuning process is finished. 	<ul style="list-style-type: none"> • See "12.3.3 Auto-Tuning of Motor".
Tuning failed. Please check Setting,Wiring Press ● key	<ul style="list-style-type: none"> • Revolving auto-tuning process is disturbed and not finished. 	<ul style="list-style-type: none"> • See "12.3.3 Auto-Tuning of Motor" for troubleshooting.
Initializing Please wait..	<ul style="list-style-type: none"> • The inverter is being initialized. 	<ul style="list-style-type: none"> • The initialization completion screen will appear after a while.
History CLR Please wait...	<ul style="list-style-type: none"> • The inverter is being initialized. 	<ul style="list-style-type: none"> • The history clearance completion screen will appear after a while.
Initialize End!! Target : ##: xxxxxxxxxx Initialize Data Sel (Ub-02) xxxxxxxxxxxxxx Load type selection (Ub-03) xxxxxxxxxxxxxx Press ● key	<ul style="list-style-type: none"> • The initialization is completed. 	<ul style="list-style-type: none"> • Press ●([SEL]) key to exit the initialization completion screen.
History CLR finished!! trip history Clear End!! Press ● key	<ul style="list-style-type: none"> • The history clearance is completed. 	<ul style="list-style-type: none"> • Press ●([SEL]) key to exit the history clearance completion screen.

Message ▶	Estimated cause(s) ▶	Exemplar measures to be taken
restricted RUN command Please check RUN command	<ul style="list-style-type: none"> Run command direction is limited by the setting of the RUN direction restriction [AA114]. The rotation direction is reversed from the command direction limited according to the setting of the RUN direction restriction [AA114] because the frequency reference is turned negative due to calculation of main speed or sub speed. 	<ul style="list-style-type: none"> Check the setting of [AA114]. Check the terminal command FW/RW and the command direction of communication command. Check whether the calculated frequency reference is negative or not.
Reset Reset Press ● key	<ul style="list-style-type: none"> [RS] terminal is ON. Trip reset was performed. (The screen is transited automatically at trip reset.) 	<ul style="list-style-type: none"> The inverter is in the condition that [RS] terminal is ON. Re-examine the state of input terminal.
Retry Retry Press ● key	<ul style="list-style-type: none"> The inverter is waiting for restart. (This mode is released after the set wait time has elapsed.) The inverter may not start if the incoming voltage is low. 	<ul style="list-style-type: none"> If the wait time for restart is long, the message will continue to be indicated. See "12.14 Each Start Mode Settings". If the incoming voltage is low, check the input voltage.
Main IP Main Power OFF Press ● key	<ul style="list-style-type: none"> The main circuit power supply (R, S, T) is turned OFF due to lightning strikes, power supply environment, or other factors. 	<ul style="list-style-type: none"> Check the state of input power supply. The inverter will recover when the power supply returns.
Main UV Please check Main Power Source Press ● key	<ul style="list-style-type: none"> The control circuit power supply (R0, T0) has been input, whereas the main circuit power supply (R, S, T) has been cut. 	<ul style="list-style-type: none"> Check the state of input power supply. The inverter will recover when the power supply of main circuit returns.
POWER OFF POWER OFF Press ● key	<ul style="list-style-type: none"> The power supply to the inverter is turned OFF. 	<ul style="list-style-type: none"> Check the state of input power supply. The inverter will recover when the power supply returns.
Ctrl UV Please check Ctrl Power Source Press ● key	<ul style="list-style-type: none"> The control circuit power supply (R0, T0) is turned OFF. 	<ul style="list-style-type: none"> Check the state of input power supply. The inverter will recover when the power supply of control circuit returns.

Message ▶	Estimated cause(s) ▶	Exemplar measures to be taken
EXT24Vdc EXT24Vdc supply Press ● key	<ul style="list-style-type: none"> The inverter is operating only with 24VDC power supply input to P+ and P- terminals. 	<ul style="list-style-type: none"> If the input power supply is input, check its state.
Load type setting Please wait...	<ul style="list-style-type: none"> The load type of inverter is being changed. 	<ul style="list-style-type: none"> The load type change completion screen will appear after a while.
Load type set End!! Load type selection (Ub-03) Rated current was changed. Please check the parameters for the current. Press ● key	<ul style="list-style-type: none"> The load type change is completed. 	<ul style="list-style-type: none"> Press ● ([SEL]) key to exit the load type change completion screen.

18.6 How to Check When Something Is Wrong



- There is something wrong.
- The inverter doesn't work as intended.
- There is no alarm output from the inverter and no trip displayed on the operator keypad, but the inverter does not work properly.



- Frequently asked questions are listed below.
- Consult this chapter to solve your problem.
- If the problem still persists, Please contact your supplier or local Hitachi inverter sales office.

Occurrence ▶	Estimated cause(s) ▶	Exemplar measures to be taken
S1: Operator keypad doesn't turn ON (the POWER LED on the operator keypad VOP is not lit.)	<ul style="list-style-type: none"> • The power supply is not turned ON. 	<ul style="list-style-type: none"> • Check that the power supply which satisfies the specification is turned ON. • When different powers are supplied to the control power supplies R0 and T0, and to P+ and P- terminals, make sure that the power supply conforms to the specifications.
	<ul style="list-style-type: none"> • Operator keypad is about to come off. 	<ul style="list-style-type: none"> • The issue will be solved by remounting the operator keypad.
	<ul style="list-style-type: none"> • The J51 connector is disconnected. 	<ul style="list-style-type: none"> • The J51 connector supplies power to the control power supplies R0 and T0 from the main power supplies R, S, and T. Keep the connector connected if you do not supply power to the control power supply with a different system.
	<ul style="list-style-type: none"> • The power supply input path is disconnected. • 200V power is supplied to R0 and T0 for 400V class. 	<ul style="list-style-type: none"> • The breaker or wires may be disconnected. You need to re-examine the wiring. • When different power is supplied to the control power supplies R0 and T0, you also need to re-examine R0 and T0.
S2: Operator keypad doesn't turn ON (the POWER LED on the operator keypad VOP is lit.)	<ul style="list-style-type: none"> • Operator keypad is in the automatic light off mode. 	<ul style="list-style-type: none"> • The screen is lit by pressing a key on the operator keypad. • The automatic light off function can be disabled in the operator keypad system setting.
	<ul style="list-style-type: none"> • The dimming setting of operator keypad display is set to low. 	<ul style="list-style-type: none"> • The brightness of the display is adjustable by changing the dimming setting in the operator keypad system setting.
	<ul style="list-style-type: none"> • Operator keypad is about to disconnect. 	<ul style="list-style-type: none"> • The issue will be solved by remounting the operator keypad. (Check the RJ45 connector.)
	<ul style="list-style-type: none"> • The operator keypad has reached the end of its life. 	<ul style="list-style-type: none"> • Replacement of the operator keypad is required.

* Also, see “18.5.1 Checking the Warning Display”.

Occurrence ▶	Estimated cause(s) ▶	Exemplar measures to be taken
<p>S3: The motor doesn't rotate although an RUN command was entered.</p>	<ul style="list-style-type: none"> The inverter is tripping. 	<ul style="list-style-type: none"> When the inverter trips due to an error, you need to remove the error factor and reset the inverter. See “18.4 Troubleshooting for Protection Functions Related Error” in this chapter.
	<ul style="list-style-type: none"> A warning is issued. 	<ul style="list-style-type: none"> If a warning is issued, you need to eliminate the data inconsistency. See “18.5 Troubleshooting for Warning Functions Related Error” in this chapter.
	<ul style="list-style-type: none"> RUN command is not entered or RUN command source is incorrect. <p style="text-align: center;">OR</p> <ul style="list-style-type: none"> Frequency reference is not entered or frequency reference source is incorrect. 	<ul style="list-style-type: none"> The RUN command source is incorrect, the RUN command is invalid, the frequency reference source is incorrect, the frequency reference is 0 Hz , or due to these complex factors, the intended operation may not be performed. <ul style="list-style-type: none"> When the RUN command is not accepted or when the motor is driven by non intended RUN command source. ⇒ Proceed to S4 When the frequency reference source is incorrect or the frequency reference is 0Hz. ⇒ Proceed to S5.
	<ul style="list-style-type: none"> A shutoff function is at work. 	<ul style="list-style-type: none"> The function safety terminal, Input terminal function 028[RS], or 032[FRS] terminal may be enabled, or 101 [REN] operation enable signal may be assigned and it turned OFF. Check the input terminal function [CA-01] to [CA-11] settings and input terminal monitor [dA-51]. ⇒ Proceed to S6.
	<ul style="list-style-type: none"> A limit function is at work. 	<ul style="list-style-type: none"> The command direction may be limited by the rotation direction limit function. ⇒ Proceed to S7.
	<ul style="list-style-type: none"> Motor speed does not increase. 	<ul style="list-style-type: none"> Acceleration operation may be limited due to overload limitation, frequency limitation or etc. ⇒ Proceed to S8.
	<ul style="list-style-type: none"> Motor is locked. 	<ul style="list-style-type: none"> If the motor shaft is locked by something which hinders the brake or the motor revolution (e.g., clogging), the cause needs to be removed.
	<ul style="list-style-type: none"> Wiring or the like is disconnected. 	<ul style="list-style-type: none"> Check for abnormalities such as disconnection of the output line to the motor or disconnection within the motor.

Occurrence ▶	Estimated cause(s) ▶	Exemplar measures to be taken
<p>S4: Run command source or RUN command is wrong.</p>	<ul style="list-style-type: none"> • Even though the RUN command is entered, the motor does not drive. 	<ul style="list-style-type: none"> • If the LED for RUN on the operator keypad is lit or the operation display appears, the run command has been entered normally. There is another factor for why the motor is not driven. ⇒ Return to S3.
	<ul style="list-style-type: none"> • The RUN command source and the RUN command input are not the same. 	<ul style="list-style-type: none"> • Check the RUN command source. Check [AA111] and the terminal function. See “12.5 Selection of RUN Command.” for details.
	<ul style="list-style-type: none"> • You want to make operation from the operator keypad but had made the different setting. 	<ul style="list-style-type: none"> • Confirm that “oFW” or “oRV” is shown on the operator keypad. If it is not shown, then confirm that the [AA111] “RUN command input source selection, 1st-motor” is set to 02(Keypad’s RUN-key). If it is shown, other factors must be checked.
	<ul style="list-style-type: none"> • You want to input a RUN command from the [FW] terminal but had made the different setting. 	<ul style="list-style-type: none"> • Set the [AA111] “RUN command input source selection, 1st-motor” to 00 [FW/RV] terminal. If RUN is not shown when the [FW] terminal is turned ON, It is necessary to check the operation inhibition function such as the operation cutoff function such as [RS] and [FRS].
	<ul style="list-style-type: none"> • You want to input a RUN command from 3-wire terminals but had made the different setting. 	<ul style="list-style-type: none"> • Set the [AA111] “RUN command input source selection, 1st-motor” to 01 (3-wire). Assign 016[STA](start), 01 [STP] (stop), 018[F/R](forward/reverse). If driving does not start even when 017[STP] and 016[STA] is turned on, other factors must be checked.
	<ul style="list-style-type: none"> • There is a cause other than the RUN command. 	<ul style="list-style-type: none"> • If “RUN” is not displayed on the keypad, the shut-off function such as [FRS] / [RS] may be on, or the main power may be off. • There is another factor for why the motor is not driven. ⇒ Return to S3.

Occurrence▶	Estimated cause(s)▶	Exemplar measures to be taken
<p>S5: Frequency reference source or frequency reference is wrong.</p>	<ul style="list-style-type: none"> • Frequency reference is 0. • [dA-04] has been 0. • Frequency reference is lower than minimum frequency setting ([Hb130] [Hb230] [Hd130] [Hd230]) 	<ul style="list-style-type: none"> • The frequency reference destination may be wrong, or the setting of the command destination or the input voltage of frequency setter may be 0. Set the value other than 0 for the setting destination. • The following shows an example where the command frequency is less than the minimum frequency setting. If STOP (red) or LIM display appears at the start, check the following. <ul style="list-style-type: none"> - The Main speed reference [FA-01] < the minimum frequency setting. - The frequency reference source is analog input, but 0V is input. - Incorrect setting of upper/lower limit settings [bA101] to [bA103]. -Setting error such as Start value setting [Cb-03] in analog adjustment.
	<ul style="list-style-type: none"> • Frequency reference source is wrong. 	<ul style="list-style-type: none"> • Check the frequency reference source. Check [AA101] and the terminal function. See "12.4 Selection of Frequency Reference" for details. • When O1 and O2 inputs were used on L300P/L700/ SL700, [AT] terminal assignment and ON were required. In the case of P1, When use only [Ai2] analog current 4 to 20 mA input (When it is unnecessary that using Ai2 or Ai3 analog input and switching Main/Sub frequency reference, or other complex usage), the [SCHG] input terminal assignment and ON/OFF is not required. [SCHG] is use only when switching between two frequency reference inputs. For details, see "12.4 Selection of Frequency Reference".
	<ul style="list-style-type: none"> • You want to set the frequency reference but [FA-01] has been 0. 	<ul style="list-style-type: none"> • Set the Main speed input source selection [AA101] to 02: Key on operator keypad, and then change the setting of [Ab110].
	<ul style="list-style-type: none"> • [FA-01] has been 0 even though the external volume for frequency setting is turned. 	<ul style="list-style-type: none"> • Set the [AA101] main speed selection to using analog input terminal and operate the volume for frequency setting.
	<ul style="list-style-type: none"> • [FA-01] is not 0, and there is a cause other than the frequency reference. 	<ul style="list-style-type: none"> • If data appears in [FA-01], the frequency reference is correct. • There is another factor for why the motor is not driven. ⇒ Return to S3.

Occurrence▶	Estimated cause(s)▶	Exemplar measures to be taken
<p>S6: A shutoff function is at work.</p>	<ul style="list-style-type: none"> The main power supply is not turned ON. 	<ul style="list-style-type: none"> When the power supply is separated to R, S, T and R0, T0 (J51 connector section), the inverter can not be operated if the R, S, T, side power is down. The power supply check is required.
	<ul style="list-style-type: none"> [RS] terminal is ON. 	<ul style="list-style-type: none"> If the [RS] terminal is ON, the inverter enters the reset mode and does not accept RUN commands. The [RS] terminal needs to be turned OFF.
	<ul style="list-style-type: none"> [FRS] terminal is ON. 	<ul style="list-style-type: none"> If the [FRS] terminal is ON, the inverter enters the free-run stop mode and does not accept RUN commands. The [FRS] terminal needs to be turned OFF.
	<ul style="list-style-type: none"> [CS] terminal is ON. 	<ul style="list-style-type: none"> If the [CS] terminal is ON, the inverter enters the mode switched to commercial power supply shutoff and does not accept RUN commands. Check the commercial switching
	<ul style="list-style-type: none"> The [REN] terminal has been assigned and is turned OFF. 	<ul style="list-style-type: none"> When the [REN] terminal is used, if the terminal is OFF, the inverter does not accept RUN commands. Check the [REN] RUN enable.
	<ul style="list-style-type: none"> STO terminal is not wired or is in OFF state. 	<ul style="list-style-type: none"> If STO function terminals are not use, the short-circuit wire must be connected (Factory default condition).
	<ul style="list-style-type: none"> The inverter is tripping. 	<ul style="list-style-type: none"> When the inverter is tripping, it does not accept RUN commands. Eliminate the cause of the trip and reset.
	<ul style="list-style-type: none"> Shutoff functions are not on. 	<ul style="list-style-type: none"> If shutoff functions are not on and the motor is not driven, there is another factor. ⇒ Return to S3.

Occurrence ▶	Estimated cause(s) ▶	Exemplar measures to be taken
<p>S7: A limit function is at work.</p>	<ul style="list-style-type: none"> The [REN] RUN enable signal has been assigned to the input terminal function and the signal is turned OFF. 	<ul style="list-style-type: none"> When the [REN] RUN enable signal has been assigned, the RUN enable signal needs to be turned ON.
	<ul style="list-style-type: none"> The RUN command is given to the direction the operation is limited. 	<ul style="list-style-type: none"> Check the RUN direction restriction [AA114]
	<ul style="list-style-type: none"> The RUN command source is input terminals, both [FW] terminal and [RV] terminals has been turned ON. 	<ul style="list-style-type: none"> If both [FW] terminal and [RV] terminal are turned ON, input inconsistency is generated and the inverter stops. Use only either one of them to run the inverter.

Occurrence ▶	Estimated cause(s) ▶	Exemplar measures to be taken
<p>S8: Motor speed doesn't rise.</p>	<ul style="list-style-type: none"> The overload limit function is at work. 	<ul style="list-style-type: none"> If the output current exceeds the [bA123]/[bA127] Overload restriction 1/2 active level when the [bA122]/[bA126] Overload restriction 1/2 mode selection are enabled, the output current is limited by automatically reducing the output frequency.
	<ul style="list-style-type: none"> The frequency reference is limited. 	<ul style="list-style-type: none"> If the [bA102] Upper frequency limit and the [Hb105]/[Hd105] Motor maximum frequency setting are set to low level, the situation will be improved by setting them to higher level. When limiting the output frequency, use the Upper frequency limit instead of the Motor maximum frequency setting.
	<ul style="list-style-type: none"> The frequency reference is low. 	<ul style="list-style-type: none"> The command frequency becomes lower when a more prioritized such as the [AG-20] Jogging frequency or [Ab-11] to [Ab-25] Multi-speed is entered. Review the frequency reference such as the input terminal function or frequency reference source selection.
	<ul style="list-style-type: none"> Acceleration time is long. 	<ul style="list-style-type: none"> If the Acceleration time setting is too long, acceleration becomes slow. Set the Acceleration time short more than current setting.

Occurrence▶	Estimated cause(s)▶	Exemplar measures to be taken
<p>S9: The parameter you are looking for is not shown.</p>	<ul style="list-style-type: none"> The display limit has been set. 	<ul style="list-style-type: none"> Display limit function may be working. Cancel the [UA-10] Display restriction selection (See section 9.10.2) . [UA-10] Display restriction selection may be locked by [UA-01] Password for display ([LKP] is displayed on the parameter setting screen). In that case, release the password lock first (See section 9.10.4).
	<ul style="list-style-type: none"> The display is fixed. 	<ul style="list-style-type: none"> Operation on the operator keypad isn't accepted if the input terminal function 102 [DISP] is ON. Turn OFF the terminal.
<p>S10: Keypad operator cannot be operated.</p>	<ul style="list-style-type: none"> The display is fixed. 	<ul style="list-style-type: none"> Operation on the operator keypad isn't accepted if the input terminal function 102 [DISP] is ON. Turn OFF the terminal.
<p>S11: Setting cannot be made.</p>	<ul style="list-style-type: none"> Inverter is running. 	<ul style="list-style-type: none"> Some parameters cannot be changed while the inverter is running. If that is the case, turn OFF the inverter once.
	<ul style="list-style-type: none"> Parameters cannot be changed. 	<ul style="list-style-type: none"> Soft lock function may be working. Check the Soft-Lock selection [UA-16]. And if input terminal 036[SFT] is assigned and it is ON, turned OFF it (See section 9.10.1) . The Soft-Lock selection [UA-16] may be locked by the Password for Soft-lock [UA-02] ([LKP] is displayed on the parameter setting screen). In this case, release the password lock first (See section 9.10.4).
<p>S12: Motor rotates in a reverse direction.</p>	<ul style="list-style-type: none"> The wires connected to the motor are in wrong phase sequence. 	<ul style="list-style-type: none"> Swapping two phases of wires connected to the motor changes the direction of rotation.
	<ul style="list-style-type: none"> When the RUN key on the operator keypad is used, the rotation direction setting is wrong. 	<ul style="list-style-type: none"> The RUN-key command rotation direction [AA-12] needs to be switched.
	<ul style="list-style-type: none"> When the 3-wire function is used, the input of input terminal function F/R is reversed. 	<ul style="list-style-type: none"> Check the logic of 3-wire normal rotation / reverse rotation terminal (018[F/R]).
<p>S13: Noises of motor and machines are noisy.</p>	<ul style="list-style-type: none"> Carrier frequency is set low. 	<ul style="list-style-type: none"> Increase the [bb101] Carrier frequency setting. However, this may increase noise generated in the inverter and leakage currents from the inverter. In addition, derating is required to the output current depending on the models.
	<ul style="list-style-type: none"> The revolution frequency of motor and the natural frequency of machines resonate. 	<ul style="list-style-type: none"> Change the frequency reference slightly to avoid resonance. If a resonance occurs during acceleration/ deceleration, avoid the resonance frequency with the [AG101] to [AG106] jump frequency functions.

Occurrence▶	Estimated cause(s)▶	Exemplar measures to be taken
<p>S14: Output frequency becomes unstable.</p>	<ul style="list-style-type: none"> Inadequate parameters are used. 	<ul style="list-style-type: none"> Find out the basic parameter settings for motor and set them accordingly.
	<ul style="list-style-type: none"> Load fluctuates significantly. 	<ul style="list-style-type: none"> Re-examination of capacity of both motor and inverter may be required.
	<ul style="list-style-type: none"> Power supply voltage fluctuates. 	<ul style="list-style-type: none"> To keep to a minimum the supply fluctuations, by using an optional AC reactor (ALI-****), DC link choke (DCL-***) or/and input filter, improvement is possible.
<p>S15: Torque is not generated.</p>	<ul style="list-style-type: none"> V/f control is used. 	<ul style="list-style-type: none"> Use the torque boost function for V / f control. Or change [AA121] Control mode selection to switch to automatic torque boost, sensorless vector control, etc. (See chapter 12.9).
	<ul style="list-style-type: none"> The inverter is used for lowering. 	<ul style="list-style-type: none"> If the torque is not sufficient for regenerative operation, use a braking resistor or regenerative braking unit.
	<ul style="list-style-type: none"> The load is too heavy. 	<ul style="list-style-type: none"> Review the required capacity for both the motor and inverter. The motor and inverter may need to be changed in some cases.
<p>S16: Operator keypad disconnection error is issued.</p>	<ul style="list-style-type: none"> Behavior setting at disconnection of keypad is inappropriate. 	<ul style="list-style-type: none"> Set the "[UA-20] Action selection at keypad disconnection" to 02 (Ignore).

Occurrence ▶	Estimated cause(s) ▶	Exemplar measures to be taken
<p>S17: Operation/setting of Modbus communication cannot be made.</p>	<ul style="list-style-type: none"> Changes made to communication parameters haven't been reflected. 	<ul style="list-style-type: none"> If the [CF-01] to [CF-38] are changed, turn OFF the control power supply and restart.
	<ul style="list-style-type: none"> The RUN command selection is not set to RS485. 	<ul style="list-style-type: none"> Check that the [AA111] "RUN command input source selection" is set to 03 (RS485).
	<ul style="list-style-type: none"> The Frequency reference selection is not set to RS485. 	<ul style="list-style-type: none"> Check that the [AA101] "Main speed input source selection" is set to 08 (RS485).
	<ul style="list-style-type: none"> The communication speed setting is wrong. 	<ul style="list-style-type: none"> Set the correct value in [CF-01], then turn OFF the control power supply and restart.
	<ul style="list-style-type: none"> Station numbers are wrongly set or overlapping each other. 	<ul style="list-style-type: none"> Set the correct value in [CF-02], then turn OFF the control power supply and restart.
	<ul style="list-style-type: none"> The communication parity setting is wrong. 	<ul style="list-style-type: none"> Set the correct value in [CF-03], then turn OFF the control power supply and restart.
	<ul style="list-style-type: none"> The communication stop bit setting is wrong. 	<ul style="list-style-type: none"> Set the correct value in [CF-04], then turn OFF the control power supply and restart.
	<ul style="list-style-type: none"> Wiring is wrong, 	<ul style="list-style-type: none"> Connect wires properly to the SP, SN and CM1 terminals on the control circuit terminal block.
<ul style="list-style-type: none"> The inverter is the last end of a daisy chain. 	<ul style="list-style-type: none"> The inverter at the last end of a daisy chain, short-circuit the RP-SN terminal to enable the terminating resistor. 	
<p>S18: The earth leakage circuit breaker is activated as the inverter is operated.</p>	<ul style="list-style-type: none"> Leakage currents in the inverter are large. 	<ul style="list-style-type: none"> Decrease the [bb101] carrier frequency setting. Increase the sensitivity current of the earth leakage circuit breaker, or replace the earth leakage circuit breaker with high sensitivity current. Enabling the built-in EMC filter increases the leakage current. If necessary, consider selecting an appropriate earth leakage breaker or turning off the EMC filter.
<p>S19: DC braking is disabled.</p>	<ul style="list-style-type: none"> The DC braking force is not set. 	<ul style="list-style-type: none"> Set the [AF105] DC braking force setting and the [AF108] DC braking force at start.
	<ul style="list-style-type: none"> The DC braking time is not set. 	<ul style="list-style-type: none"> Set the [AF106] DC braking active time at stop and the [AF109] DC braking active time at start.
<p>S20: TV and radio have noises near the inverter.</p>	<ul style="list-style-type: none"> Radiation noise from the inverter 	<ul style="list-style-type: none"> Locate the inverter wires as far as possible from a TV and radio. Install the radio noise filter (zero-phase reactor) to the main power supply input and output of the inverter.

19

Chapter 19 Maintenance and Inspection

Contents

- 19.1 What This Chapter Explains 19-1
- 19.2 Notes on Maintenance and Inspection 19-2
 - 19.2.1 Daily Inspection 19-2
 - 19.2.2 Cleaning 19-2
 - 19.2.3 Periodic Inspection 19-2
 - 19.2.4 Periodical Functional Test for STO 19-2
- 19.3 Daily Inspection and Periodic Inspection 19-3
- 19.4 Megger Test 19-4
- 19.5 Withstand Voltage Test 19-4
- 19.6 Checking Method of Inverter and Converter 19-5
- 19.7 Smoothing Capacitor Life Curve 19-6
- 19.8 Life Alarming Output 19-6
- 19.9 Measurement Method of I/O Voltage, Current, and Power 19-7

19.1 What This Chapter Explains

- This chapter describes methods of maintenance and inspection.
- **Carefully read "Chapter 1 Safety Instructions/Risks" again before performing maintenance and inspection.**

* Components that have finite lives are electrolytic condenser on board, smoothing capacitor, IGBT, diode module, current limiting resistor, relay for driving current limiting resistor or thyristor, cooling fan, and memory element, which are mounted on the board.

Be careful for maintenance and inspection!





Electric shock

- **You run the risk of electric shock.**
- Before inspecting the inverter, be sure to turn off the power supply and wait for 10 minutes or more (*1) or 15 minutes or more (*2). (Confirm that the charge lamp on the inverter is turned off and the DC voltage between terminals P and N is 45 VDC or less.)



Prohibited

- Entrust only a designated person for maintenance, inspection, and replacement of parts. (Be sure to remove wristwatches and metal accessories, e.g., bracelets, before maintenance and inspection work. Be sure to use insulated tools for the work.)



Do



Prohibited

- Do not perform pressure test.

*1) For models P1-00044-L to P1-01240-L (P1-004L to P1-220L) and P1-00041-H to 00620-H (P1-007H to P1-220H)
 *2) For models P1-01530-L to P1-02950-L (P1-300L to P1-550L) and P1-00770-H to P1-06600-H (P1-300H to P1-3150H)

19.2 Notes on Maintenance and Inspection

19.2.1 Daily Inspection

As a basic procedure, check that the following abnormalities are not observed during operation.

No.	Description	Check
1	The motor operates according to the settings	<input type="checkbox"/>
2	There is no abnormality in the environment where the device is installed.	<input type="checkbox"/>
3	There is no abnormality in the cooling system.	<input type="checkbox"/>
4	No abnormal vibration or sound is observed.	<input type="checkbox"/>
5	No abnormal overheat or discoloration is observed.	<input type="checkbox"/>
6	No abnormal smell is observed.	<input type="checkbox"/>

While the inverter is running, check the input voltage of inverter using a tester, etc.

No.	Description	Check
1	There is no frequent occurrence of variation of power supply voltage.	<input type="checkbox"/>
2	Line voltage keeps a good balance.	<input type="checkbox"/>

19.2.2 Cleaning

Keep the inverter in a clean condition.

No.	Description	Check
1	When cleaning the inverter, use a soft cloth soaked in neutral detergent to gently wipe up the dirtied parts.	<input type="checkbox"/>
2	Solvents such as acetone, benzene, toluene, and alcohol may cause the inverter surface to dissolve or its coating to peel off, therefore, do not use them.	<input type="checkbox"/>
3	Do not use solvents such as acetone, benzene, toluene or alcohol as they may melt the surface or strip the coating of the inverter.	<input type="checkbox"/>

19.2.3 Periodic Inspection

Check sections that cannot be inspected unless operation is stopped and sections requiring periodic inspection.

Please contact your supplier or local Hitachi inverter sales office for periodic inspection.

No.	Description	Check
1	There is no abnormality in the cooling system. · Cleaning of the air filter and other components	<input type="checkbox"/>
2	Checking tightness and re-tightening · Due to effects of vibration or temperature change, tightened portions of screws or bolts may loosen. Make sure to carefully check and perform the work.	<input type="checkbox"/>
3	No corrosion or damage is observed on the conductors and insulators.	<input type="checkbox"/>
4	Measurement of insulation resistance	<input type="checkbox"/>
5	Checking and replacing the cooling fan, smoothing capacitor, and relay	<input type="checkbox"/>

19.2.4 Periodical Functional Test for STO

When handling this product as a functional safety certified product, be sure to perform the following items. For details, refer to the separate volume "SJ Series P1 Safety Function Guide" (NT2512*X).

- A periodical STO functional test must be performed at least once in a year in order to maintain the intended safety performance level of the STO function.
- This periodical STO function test is one of the conditions for the STO function of SJ-P1 to meet PLe of EN ISO13849-1 and SIL 3 of IEC61800-5-2.

19.3 Daily Inspection and Periodic Inspection

Inspected part	Inspection entry	Details of inspection	Inspection cycle			Inspection method	Criterion	Tester device
			Daily	Every				
				1 year	2 years			
General	Surrounding environment	Check the ambient temperature, level of humidity, dust, ... etc..	○			Refer to "Chapter 6 Installation" .	Ambient temperature, level of humidity are within the range. No frozen part. No condensation.	Thermometer. Hygrometer. Data logger.
	Whole inverter	Check that there are no abnormal vibrations or noises.	○			Check visually and auditorily.	No abnormality.	
	Power supply voltage	Check that the main circuit voltage is normal.	○			Measure the line-to-line voltage of the inverter main circuit terminals R,S and T.	Within the AC voltage permissible variation.	Multimeter, Digital multimeter.
Main circuit	General check	(1)Check the resistance between the main circuit and the ground terminals.		○		Remove the inverter main circuit terminals input/output wiring and the control terminal board, and remove the jumper for the internal filter, after that, shortcircuit the terminals R,S,T,U,V,W,P,PD,N,RB,RO,TO, and measure between this shortcircuit and the ground.	Resistance no less than 5MΩ.	DC 500V class Ohmmeter. (megger®)
		(2)Check looseness in fastened parts.		○		Confirm tighten of fasteners.	No abnormality.	
		(3)Check for overheating traces.		○		Check visually.	No abnormality.	
	Conductor and cables	(1)Check for straining in conductors.		○		Check visually.	No abnormality.	
		(2)Check for cable coating damage.		○				
	Terminal block	Check for any damage.		○		Check visually.	No abnormality.	
	Inverter and converter circuits (Including resistors)	Check the resistance between all the terminals.			○	Remove the inverter main circuit terminal wiring, and measure the following: - Resistance between terminals RST and PN. - Resistance between terminals UVW and PN	Refer the "19.6 Checking Method of Inverter and Converter". The inverter, capacitor and thyristor lifespan before replacing the components is of 10 ⁶ start/stop cycles. *3)	Analog multimeter.
	Smoothing capacitor	(1)Check for capacitor fluid leakage		○		Check visually.	No abnormality. Estimated years life span before exchanging component: 10 years. *1) *3) *4)	
(2)Check that the relief valve does not swells or protudes.			○					
Relay	(1)No chatter sound while operating.		○		Check auditorily.	No abnormality.		
	(2)Check contacts for damage.		○		Check visually.	No abnormality.		
Control and protection circuits	Operation check	(1) While performing a unit operation of the inverter, check the balance of the output voltage among the individual phases.		○		Measure the voltage between the U,V,W terminals of the inverter main circuit.	Phase-to-phase voltage balance 200V class: within 4V. 400V class: within 8V.	Digital multimeter. Voltmeter. Ammeter.
		(2)Carry out a sequential protection test, and check the protective and display circuits for any abnormality.		○		Simulate a shortcircuit or open of the inverter output protection circuit.	An error must be detected according to the sequence.	
Cooling system	Cooling-fan	(1) Check that there are no abnormal vibrations or noises.	○			Turn by hand while electricity is not being supplied.	Smooth operation. No abnormality. Replace every: 10 years. *2) *3) *5)	
		(2)Check for loose joints.		○		Check visually.	Check that there is no clogging.	
Heat sink	Check for obstructions/clogging.			○		Check visually.		
	Display	(1) Check if the charge lamp and the Keypad's LEDs and LCD light up.	○			Check visually.	Confirm they light up.	
(2)Display cleaning.			○		With cleaning rag.			
Meter	Check that indicated values are normal.		○			Check the meters readings on the control panel.	Regulation and control value are satisfactory.	Voltmeter. Ammeter. Etc.
	General	(1)Check that there are no abnormal vibrations or noises.	○			Check visually, auditorily, and by touch.	No abnormality.	
(2)Check that there is no odour.		○			Check for abnormal superheating, damages and so on.	No abnormality.		
Motor	Insulation resistance	Check the resistance between the main circuit and the ground terminals.			*6)	Remove the wiring from the main circuit terminals U, V, W of the inverter, shortcircuit the motor wire (for 3 phases), and measure with a Megger® between the motor wire and the ground terminal.	No less than 5MΩ.	DC 500V class Ohmmeter. (megger®)

*1) The life span of the smoothing capacitor is influenced by the ambient temperature. Refer to "19.7 Smoothing Capacitor Life Curve" for replacing measures.

*2) The life span of the cooling-fan is influenced by the ambient temperature, the dirt and the change in its environmental conditions. Check these circumstances on the usual inspection.

*3) The estimated time before replacement (Number of years/cycle) and the [Smoothing capacitor life span curve] are based on the design lifespan, not guaranteed.

*4) In the case that the capacitors are replaced after that the storage period of 3 years has expired, perform aging under the following conditions before using the inverter:

- First, apply for 1 hour the 80% of the capacitor rated voltage at ambient temperature.
- Then, raise the voltage to 90%, and keep it for 1 more hour.
- Finally, apply for 5 hours the rated voltage at ambient temperature.

*5) If the cooling fan is locked due to dust, etc., it takes 5 to 10 seconds to restart even if dust is removed.

*6) Follow the instruction manual for the motor.

19.4 Megger Test

- When testing an external circuit with a megger, disconnect all the external circuit cables from the inverter to prevent it from being exposed to the test voltage.
- In the control circuit carry out a conduction test, use a tester (with high resistance range), do not use a megger® or buzzer /continuity tester.
- The insulation resistance test of the inverter itself is carried out only at the main circuit, do not perform an insulation resistance test in the control circuit.
- For megger® test, use a 500 VDC megger.
- Before the main circuit test with a megger, remove the jumper for switching the inverter's internal filter function, and then connect terminals R, S, T, U, V, W, P, PD, N, RB, R0, and T0 by wires as shown in the figure below. Subsequently, carry out the test.
- After the test using the megger, remove the wires from terminals R, S, T, U, V, W, P, PD, N, RB, R0, and T0, and connect the jumper for switching the inverter's internal filter function at the original position.
- Furthermore, depending on the model, the RB terminal may not be present. Please confirm in chapter "7.5 Connect Wire to the Main Circuit Terminal Block".
- Because the insulation resistance rating of the single inverter unit is 5 MΩ or higher, it is normal if the resistance is 5 MΩ or higher.

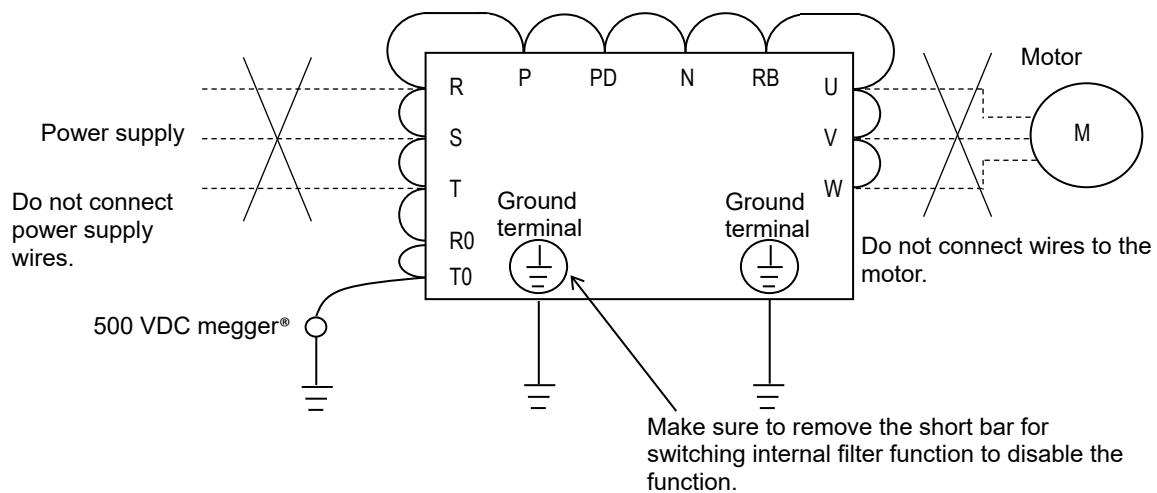

19.5 Withstand Voltage Test

- Do not carry out a withstand voltage test for the inverter. The test may damage its internal parts, deteriorating the inverter.

19.6 Checking Method of Inverter and Converter

- Using the analog multimeter, you can check if the inverter or converter unit are defective or non-defective.
- (preparation)
 - (i) Remove the power lines connected from an external supply (R, S, T), wires connecting to the motor (U, V, W), and regenerative braking resistor (P, RB).
 - (ii) Prepare a tester. (The range used is 1Ω resistance measurement range.)
- (Checking method) *1)
 - You can determine the good-or-bad condition of conduction status of terminals on the inverter main circuit terminal block R, S, T, U, V, W, RB, P, and N by alternately changing the polarity of tester for measurement.

- *1) By measuring the voltage between P and N in the DC voltage range, check that electricity is fully discharged from the smoothing capacitor before performing check.
- *2) When electricity is not conducted, a nearly infinite value is demonstrated. Due to effects of the smoothing capacitor, electricity may be conducted instantly and may not show infinity value. When electricity is conducted, a numeric value range will be indicated from some to dozens in a unit of Ω. The values vary depending on the element type, tester, type, etc. However, it is acceptable if numeric values obtained for each item are nearly the same. The measured value may be shifted by several ohms due to the current limiting resistance for preventing inrush current.
- *3) The chopper braking circuit (BRD) is equipped as standard on the following models:
 P1-00044-L to P1-01240-L (P1-004L to P1-220L) and P1-00041-H to P1-00930-H (P1-007H to P1-370H)

		Tester polarity		Measured value *2)
		⊕ (Red)	⊖ (Black)	
Converter	D1	R	PD	Non-conductive
		PD	R	Conductive
	D2	S	PD	Non-conductive
		PD	S	Conductive
	D3	T	PD	Non-conductive
		PD	T	Conductive
D4	R	N	Conductive	
	N	R	Non-conductive	
D5	S	N	Conductive	
	N	S	Non-conductive	
D6	T	N	Conductive	
	N	T	Non-conductive	
Inverter	TR1	U	P	Non-conductive
		P	U	Conductive
	TR2	V	P	Non-conductive
		P	V	Conductive
	TR3	W	P	Non-conductive
		P	W	Conductive
TR4	U	N	Conductive	
	N	U	Non-conductive	
TR5	V	N	Conductive	
	N	V	Non-conductive	
TR6	W	N	Conductive	
	N	W	Non-conductive	
BRD	TR7	RB	P	Non-conductive
		P	RB	Conductive
		RB	N	Don't care
		N	RB	Non-conductive

Model (P1-**-*)(P1-****)**
 200V class: 00044-L (004L) to 00600-L (110L)
 400V class: 00041-H (007H) to 00310-H (110H)

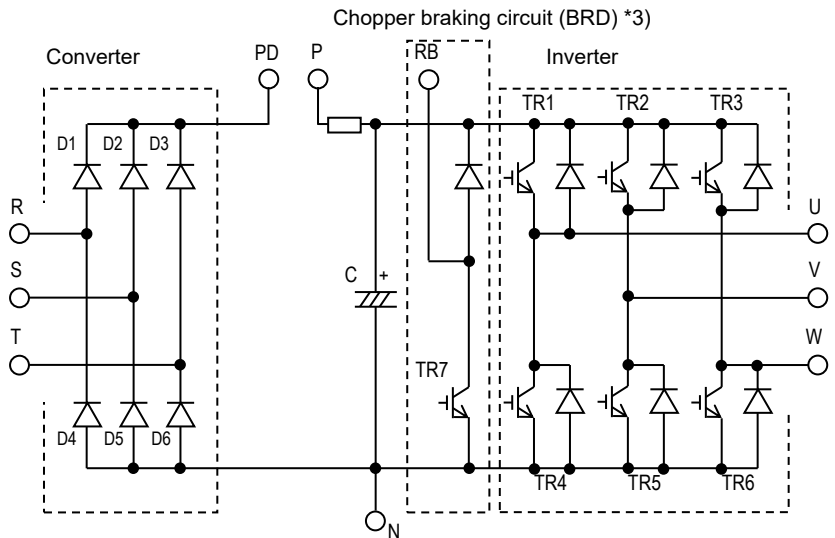

Model (P1-**-*)(P1-****)**
 200V class: 00800-L (150L) to 02950-L (550L)
 400V class: 00400-H (150H) to 06600-H (3150H)

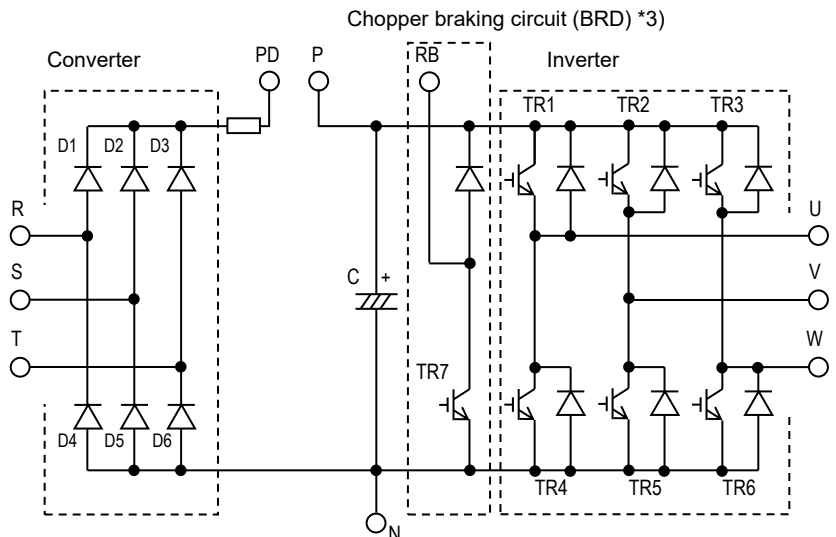

19.7 Smoothing Capacitor Life Curve

* When the inverter is continuously driven at 80% of ND rated current.

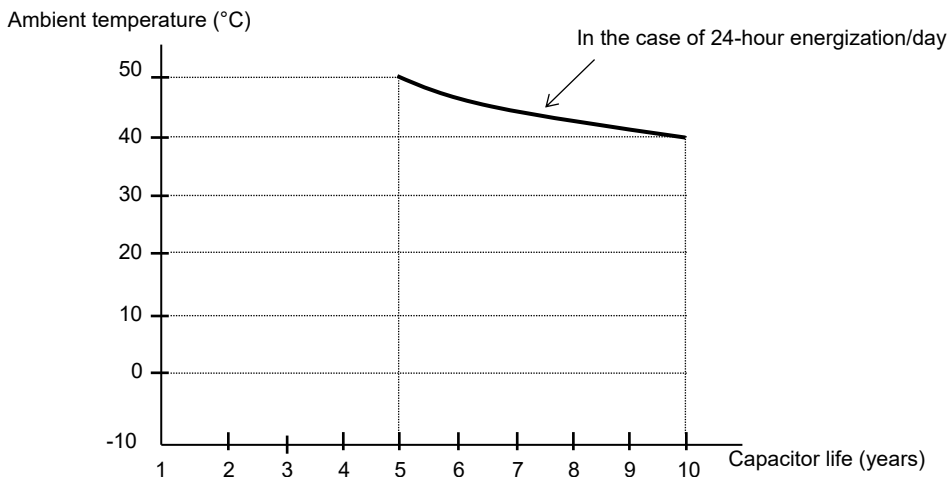

Note 1) The ambient temperature is a temperature measured at a position about 5cm from the bottom center of the inverter. (atmospheric temperature)
If the inverter is stored inside the panel, it is in-panel temperature.

Note 2) The smoothing capacitor is a finite life component which occurs chemical reaction inside, replacement is required after 10 years of use (It is a designed expected life, not a guaranteed value).
However, if the inverter is used in an environment at high temperature or in a heavy-load environment where the its rated current is exceeded, the life is significantly shortened.

19.8 Life Alarming Output

- By the self-diagnostic, it is possible to output an alarm in regards of the inverter own internal components lifespan when the lifespan is nearing to its end (Including the circuit board electrolytic capacitor and cooling-fan, and excluding the main circuit smoothing capacitor).
Use this to get a reference for when the components should be replaced. Particularly, consult the lifespan diagnosis monitor [dC-16] and the output terminal function selection [CC-01] to [CC-07].
It should be noted that the warning itself is based on the design lifespan, and thus, is not a guaranteed measurement.
Depending on the environment, the operation conditions, etc. problems may arise, to avoid that, is recommended an early maintenance.

19.9 Measurement Method of I/O

Voltage, Current, and Power

Standard equipment for measuring input/output voltage, current, and power measurement.

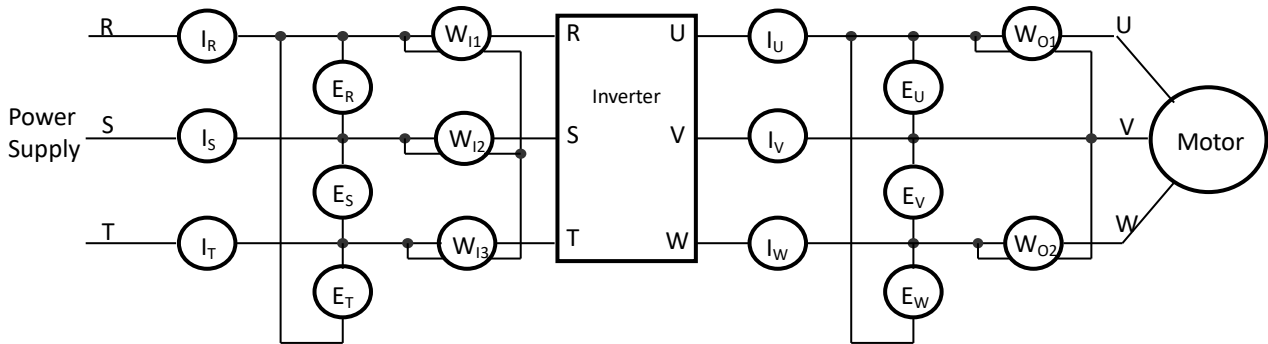

Measured data	Measuring point	Measuring instrument	Remarks	Standard reference values
Input voltage E_{IN}	R-S, S-T, T-R (E_R), (E_S), (E_T)	Moving-iron voltmeter or Rectifier-type voltmeter	Effective value of full waves	200V class:200 to 240V 50/60Hz 400V class:380 to 500V 50/60Hz
Input current I_{IN}	R, S, T current (I_R), (I_S), (I_T)	Moving-iron ammeter	Effective value of full waves	If there is unbalance in the input supply $I_{IN}=(I_R+I_S+I_T)/3$
Input power W_{IN}	R-S, S-T, T-R (W_{I1})+(W_{I2})+(W_{I3})	Electrodynamometer-type wattmeter	Effective value of full waves	Three-wattmeter method
Input power factor Pf_{IN}	Is calculated from the measured values of the input voltage (E_{IN}), input current (I_{IN}) and supply power (W_{IN}) $Pf_{IN} = \frac{W_{IN}}{\sqrt{3} \times E_{IN} \times I_{IN}} \times 100$			
Output voltage E_{OUT}	U-V, V-W, W-U (E_U), (E_V), (E_W)	Moving-iron voltmeter or Rectifier-type voltmeter	Effective value of fundamental wave	
Output current I_{OUT}	U, V, W current (I_U), (I_V), (I_W)	Moving-iron ammeter	Effective value of full waves	
Output power W_{OUT}	U-V, V-W (W_{O1})+(W_{O2})	Electrodynamometer-type wattmeter	Effective value of full waves	Two-wattmeter method (Otherwise the three-wattmeter method)
Output power factor Pf_{OUT}	Is calculated from the measured values of the output voltage (E_{OUT}), output current (I_{OUT}) and output power (W_{OUT}). $Pf_{OUT} = \frac{W_{OUT}}{\sqrt{3} \times E_{OUT} \times I_{OUT}} \times 100$			

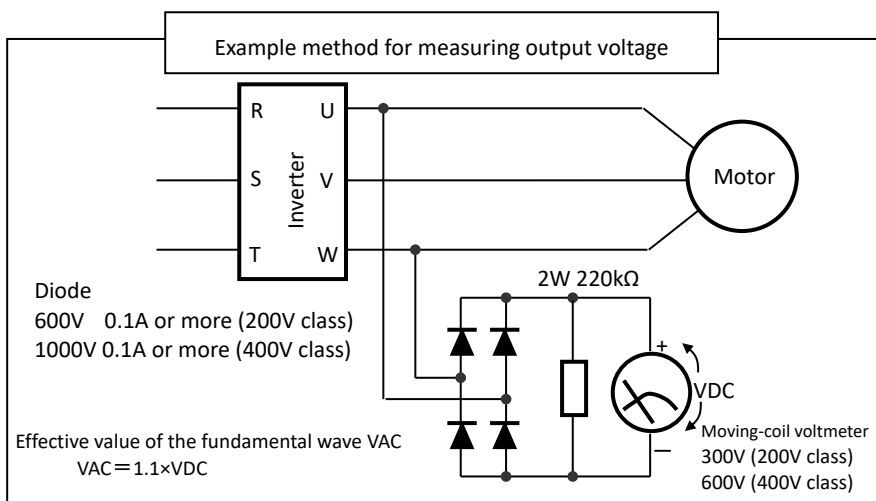

When measuring...

1. To measure the output voltage, use an instrument that reads the effective value of the fundamental wave. To measure the current or the power, use an instrument that reads the effective value of full waves.
2. Since the inverter output waveform is controlled by PWM, it has a large margin of error, especially at low frequencies. In many cases, general multimeters may be defective for the measurement, because of the adverse effects of the noise.

(memo)

20

Chapter 20 Specifications

Contents

20.1 What This Chapter Explains	20-1
20.2 Inverter Specifications	20-2
20.2.1 200V Class Specifications	20-2
20.2.2 400V Class Specifications	20-3
20.2.3 Common Specifications	20-5
20.3 External Dimensions	20-7
20.4 Current Derating	20-19
20.4.1 200V Class	20-19
20.4.2 400V Class	20-22

20.1 What This Chapter Explains

This chapter describes product specifications. The abbreviations used in the product specifications show the following meanings.

Rated duty:

- ND (normal duty rating)
- LD (low duty rating)
- VLD (very low duty rating)

Motor types:

- IM (induction motor)
- SM/PMM: (synchronous motor/permanent magnet motor)



In the following, if the specifications are the same for each model, part of the model name is omitted. For example, if P1-0044-LFUF is written as P1-****-L, this is specific to the 200 V class but does not depend on the region code or etc. Details of the model name, see "4.3.1 Model of the Product".

20.2 Inverter Specifications

20.2.1 200V Class Specifications

The model name of 200V class are P1-****-LFF, P1-****-LFEF, P1-****-LFUF or P1-****-LFCF.
The portion "****" are filled with numbers described in "Model name".

Model name P1-****-L		00044	00080	00104	00156	00228	00330	00460	00600	00800	00930	01240	01530	01850	02290	02950		
ND Rating Code P1-****L		004	007	015	022	037	055	075	110	150	185	220	300	370	450	550		
Applicable motor capacity (kW) (4 poles)	VLD	0.75	1.5	2.2	3.7	5.5	7.5	11	15	18.5	22	30	37	45	55	75		
	LD	0.75	1.5	2.2	3.7	5.5	7.5	11	15	18.5	22	30	37	45	55	75		
	ND	0.4	0.75	1.5	2.2	3.7	5.5	7.5	11	15	18.5	22	30	37	45	55		
Output	Rated output current(A) *1)	VLD	4.4	8.0	10.4	15.6	22.8	33.0	46.0	60.0	80.0	93.0	124	153	185	229	295	
		LD	3.7	6.3	9.4	12.0	19.6	30.0	40.0	56.0	73.0	85.0	113	140	169	210	270	
		ND	3.2	5.0	8.0	11.0	17.5	25.0	32.0	46.0	64.0	76.0	95.0	122	146	182	220	
	Overload current rating *1)	VLD	110% 60sec / 120% 3sec															
		LD	120% 60sec / 150% 3sec															
		ND	150% 60sec / 200% 3sec															
	Rated output voltage		Three-phase (3 wire) 200 to 240 V (Corresponding to the incoming voltage)															
	Rated capacity (kVA)	200V	VLD	1.5	2.7	3.6	5.4	7.8	11.4	15.9	20.7	27.7	32.2	42.9	53.0	64.0	79.3	102
			LD	1.2	2.1	3.2	4.1	6.7	10.3	13.8	19.3	25.2	29.4	39.1	48.4	58.5	72.7	93.5
			ND	1.1	1.7	2.7	3.8	6.0	8.6	11.0	15.9	22.1	26.3	32.9	42.2	50.5	63.0	76.2
240V		VLD	1.8	3.3	4.3	6.4	9.4	13.7	19.1	24.9	33.2	38.6	51.5	63.6	76.9	95.1	123	
		LD	1.5	2.6	3.9	4.9	8.1	12.4	16.6	23.2	30.3	35.3	46.9	58.1	70.2	87.2	112	
		ND	1.3	2.0	3.3	4.5	7.2	10.3	13.3	19.1	26.6	31.5	39.4	50.7	60.6	75.6	91.4	
Input	Rated input current(A) *2)	VLD	5.2	9.5	12.4	18.6	27.1	39.3	54.8	71.4	95.2	111	148	182	220	273	351	
		LD	4.4	7.5	11.2	14.3	23.3	35.7	47.6	66.7	86.9	101	135	167	201	250	321	
		ND	3.8	6.0	9.5	13.1	20.8	29.8	38.1	54.8	76.2	90.5	113	145	174	217	262	
	Rated input AC voltage *3)		Control power supply : Single-phase supply 200 to 240 V (Permissible AC voltage 170 to 264 V) , 50 Hz (allowable variation range: 47.5 to 52.5 Hz) / 60 Hz (allowable variation range:57 to 63 Hz) Main circuit power supply: Three-phase (3 wire) 200 to 240 V (Permissible AC voltage 170 to 264 V) , 50 Hz(allowable variation range: 47.5 to 52.5 Hz) / 60 Hz (allowable variation range:57 to 63 Hz)															
	Power supply capacity (kVA) *4)	VLD	2.0	3.7	4.8	7.1	10.4	15.0	20.9	27.3	36.3	42.2	56.3	69.4	84.0	104	134	
		LD	1.7	2.9	4.3	5.5	8.9	13.7	18.2	25.5	33.2	38.6	51.3	63.6	76.7	95.3	123	
ND		1.5	2.3	3.7	5.0	8.0	11.4	14.6	20.9	29.1	34.5	43.1	55.4	66.3	82.6	99.8		
Carrier frequency variation *5)	VLD	0.5 to 10.0kHz																
	LD	0.5 to 12.0kHz																
	ND	0.5 to 16.0kHz																
Motor start torque *6)		200%/0.3Hz																
Braking	Regenerative	Internal BRD circuit (external discharge resistor value)												External regenerative braking unit				
	Minimum resistance value(Ω)	50	50	35	35	35	16	10	10	7.5	7.5	5	-	-	-	-		
Dimensions *7)	H(height)(mm)	255	255	255	255	255	260	260	260	390	390	390	540	550	550	700		
	W(width)(mm)	150	150	150	150	150	210	210	210	245	245	245	300	390	390	480		
	D(Depth)(mm)	140	140	140	140	140	170	170	170	190	190	190	195	250	250	250		
Protective structure		IP20 – UL Open Type																
Aprox. weight (kg)		3	3	3	3	3	6	6	6	10	10	10	22	33	33	47		

*1) Some models require current derating depending on the carrier frequency setting and ambient temperature. For details, please refer to "20.4 Current Derating". (Please contact us for models not described in the Basic / User's Guide.)

*2) The rated input current is the value when the drive is operated in the rated output current. The value of the impedance at the supply side changes due to the wiring, breaker, input reactor, etc. In addition, the input current on the specification label is a UL-certified current.

*3) Following are for Low Voltage Directive (LVD) compliant.

- Pollution degree 2
- Overvoltage category 3

*4) The power supply capacity is the value of the rated output current at 220V. The value of the impedance at the supply side changes due to the wiring, breaker, input reactor, etc.

*5) The setting range of carrier frequency [bb101] / [bb201] is limited according to the [Ub-03] setting (load type selection).
It is recommended to set the carrier frequency settings [bb101]/[bb201] equal or greater than the (maximum output frequency x 10) Hz.
For induction motor IM, it is recommended to set the carrier frequency to 2 kHz or more except V/f control. For synchronous motor (SM) / Permanent magnet motor (PMM), it is recommended to set the carrier frequency to 8 kHz or more.

*6) The value is specified for the Hitachi standard motor controlled by the sensorless vector control when ND rating.
Torque characteristics may vary by the control system and the use of the motor.

*7) The key height of keypad are excluded from dimensions. When an option is connected, the depth is increased. Refer to the each option Guide.

20.2.2 400V Class Specifications

The model name of 400V class are P1-****-HFF, P1-****-HFEF, P1-****-HFUF or P1-****-HFCF.
The portion "****" are filled with numbers described in "Model name".

Model name P1-****-H		00041	00054	00083	00126	00175	00250	00310	00400	00470	00620	00770	00930	01160	01470	01760	02130	02520	03160		
ND Rating Code P1-***H		007	015	022	037	055	075	110	150	185	220	300	370	450	550	750	900	1100	1320		
Applicable motor capacity (kW) (4 poles)	VLD	1.5	2.2	3.7	5.5	7.5	11	15	18.5	22	30	37	45	55	75	90	110	132	160		
	LD	1.5	2.2	3.7	5.5	7.5	11	15	18.5	22	30	37	45	55	75	90	110	132	160		
	ND	0.75	1.5	2.2	3.7	5.5	7.5	11	15	18.5	22	30	37	45	55	75	90	110	132		
Output	Rated output current (A) *1)	VLD	4.1	5.4	8.3	12.6	17.5	25.0	31.0	40.0	47.0	62.0	77.0	93.0	116	147	176	213	252	316	
		LD	3.1	4.8	6.7	11.1	16.0	22.0	29.0	37.0	43.0	57.0	70.0	85.0	105	135	160	195	230	290	
		ND	2.5	4.0	5.5	9.2	14.8	19.0	25.0	32.0	39.0	48.0	61.0	75.0	91.0	112	150	180	217	260	
	Overload current rating	VLD	110 % 60 sec / 120 % 3 sec																		
		LD	120 % 60 sec / 150 % 3 sec																		
		ND	150 % 60 sec / 200 % 3 sec																		
	Rated output voltage		Three-phase (3 wire) 380 to 500 V (Corresponding to the incoming voltage)																		
	Rated capacity (kVA)	400V	VLD	2.8	3.7	5.7	8.7	12.1	17.3	21.4	27.7	32.5	42.9	53.3	64.4	80.3	102	122	148	175	219
			LD	2.1	3.3	4.6	7.6	11.0	15.2	20.0	25.6	29.7	39.4	48.4	58.8	72.7	93.5	111	135	159	201
			ND	1.7	2.7	3.8	6.3	10.2	13.1	17.3	22.1	27.0	33.2	42.2	51.9	63.0	77.5	104	125	150	180
500V		VLD	3.5	4.6	7.1	10.9	15.1	21.6	26.8	34.6	40.7	53.6	66.6	80.5	100	127	152	184	218	274	
		LD	2.6	4.1	5.8	9.6	13.8	19.0	25.1	32.0	37.2	49.3	60.6	73.6	90.9	117	139	169	199	251	
		ND	2.1	3.4	4.7	7.9	12.8	16.4	21.6	27.7	33.7	41.5	52.8	64.9	78.8	96.9	130	156	188	225	
Input	Rated input current (A)*2)	VLD	4.9	6.4	9.9	15.0	20.8	29.8	36.9	47.6	56.0	73.8	91.7	111	138	175	210	254	300	376	
		LD	3.7	5.7	8.0	13.2	19.0	26.2	34.5	44.0	51.2	67.9	83.3	101	125	161	191	232	274	345	
		ND	3.0	4.8	6.5	11.0	17.6	22.6	29.8	38.1	46.4	57.1	72.6	89.3	108	133	179	214	258	310	
	Rated input AC voltage *3)		Control power supply: Single-phase supply 380 to 500 V (Permissible AC voltage 323 to 550 V) , 50 Hz(allowable variation range: 47.5 to 52.5 Hz) / 60 Hz (allowable variation range:57 to 63 Hz) Main circuit power supply: Three-phase(3 wire) 380 to 500 V (Permissible AC voltage 323 to 550 V) , 50 Hz(allowable variation range: 47.5 to 52.5 Hz) / 60Hz(allowable variation range: 57 to 63 Hz)																		
	Power supply capacity (kVA) *4)		VLD	3.8	4.9	7.6	11.5	15.9	22.8	28.2	36.3	42.7	56.3	69.9	84.4	105	133	160	193	229	287
	LD	2.9	4.4	6.1	10.1	14.5	20.0	26.3	33.6	39.1	51.8	63.5	77.2	95.3	123	145	177	209	263		
	ND	2.3	3.7	5.0	8.4	13.5	17.3	22.8	29.1	35.4	43.6	55.4	68.1	82.6	102	136	163	197	236		
Carrier frequency variation *5)		VLD	0.5 to 10.0 kHz														0.5 to 8.0 kHz				
	LD	0.5 to 12.0 kHz														0.5 to 8.0 kHz					
	ND	0.5 to 16.0 kHz														0.5 to 10.0 kHz					
Starting torque *6)		200 % / 0.3 Hz														180 % / 0.3 Hz					
Braking	Regenerative	Internal BRD circuit (external discharge resistor value)												*8)		External regenerative braking unit					
	Minimum resistance value(Ω)	100	100	100	70	70	35	35	24	24	20	15	15	10	10						
Dimensions *7)	H(height)(mm)	255	255	255	255	260	260	260	390	390	390	540	550	550	550	700	700	740	740		
	W(width)(mm)	150	150	150	150	210	210	210	245	245	245	300	390	390	390	390	390	480	480		
	D(Depth)(mm)	140	140	140	140	170	170	170	190	190	190	195	250	250	250	270	270	270	270		
Protective structure		IP20 – UL Open Type																			
Aprox.weight (kg)		3	3	3	3	6	6	6	8.5	8.5	8.5	22	31	31	31	41	41	53	53		

- *1) Some models require current derating depending on the carrier frequency setting and ambient temperature. For details, please refer to "20.4 Current Derating". (Please contact us for models not described in the Basic / User's Guide.)
- *2) The rated input current is the value when the drive is operated in the rated output current. The value of the impedance at the supply side changes due to the wiring, breaker, input reactor, etc. In addition, the input current on the specification label is a UL-certified current.
- *3) Make sure the following for Low Voltage Directive (LVD) compliant.
- Pollution degree 2, - Overvoltage category 3 (for 380 to 460 Vac Input supply), - Overvoltage category 2 (for over 460Vac Input supply)
- *4) The power supply capacity is the value of the rated output current at 440V. The value of the impedance at the supply side changes due to the wiring, breaker, input reactor, etc.
- *5) The setting range of carrier frequency [bb101] / [bb201] is limited according to the [Ub-03] setting (load type selection).
It is recommended to set the carrier frequency settings [bb101] / [bb201] equal or greater than the (maximum output frequency x 10) Hz. For induction motor IM, it is recommended to set the carrier frequency to 2 kHz or more except V/f control. For synchronous motor (SM) / Permanent magnet motor (PMM), it is recommended to set the carrier frequency to 8 kHz or more.
- *6)The value is specified for the Hitachi standard motor controlled by the sensorless vector control when ND rating.
Torque characteristics may vary by the control system and the use of the motor.
- *7) The key height of keypad are excluded from dimensions. When an option is connected, the depth is increased. Refer to the each option Guide
- *8) Usually an external regenerative braking unit is required. However, with an optional built –in chopper braking circuit and external discharge resistor can eliminate a external regenerative unit. The built-in chopper braking circuit is offered by order. In order to purchase, contact to the nearest sales office.

400V Class Specifications (Continuation)

The model name of 400V class are P1-****-HFF, P1-****-HFEF, P1-****-HFUF or P1-****-HFCF.
The portion "****" are filled with numbers described in "Model name".

Model name P1-****-H		03720	04320	04860	05200	05500	06600		
ND Rating Code P1-****-H		1600	1850	2000	2200	2500	3150		
Applicable Motor capacity (kW) (4 poles)	VLD *8)	185	200	220	250	-	-		
	LD	185	200	220	250	280	355		
	ND	160	185	200	220	250	315		
Output	Rated output current (A) *1)	VLD *8)	372	432	486	520	-	-	
		LD	341	395	446	481	550	660	
		ND	310	370	405	450	500	600	
	Overload current rating	VLD *8)	110 % 60 sec / 120 % 3 sec					—	
		LD	120 % 60 sec / 150 % 3 sec						
		ND	150 % 60 sec / 200 % 3 sec						
	Rated output voltage		Three-phase (3 wire) 380 to 500 V (Corresponding to the incoming voltage)						
	Rated capa- city (kVA)	400V	VLD *8)	258	299	337	360	-	-
			LD	236	274	309	333	381	457
			ND	215	256	281	312	346	416
500V		VLD *8)	322	374	421	450	-	-	
		LD	295	342	386	417	476	572	
		ND	268	320	351	390	433	520	
Input	Rated input current (A) *2)	VLD *8)	443	514	579	619	-	-	
		LD	406	470	531	573	655	786	
		ND	369	441	482	536	595	714	
	Rated input AC voltage *3)		Control power supply: Single-phase supply 380 to 500 V (Permissible AC voltage 323 to 550 V), 50 Hz (allowable variation range: 47.5 to 52.5 Hz) / 60 Hz (allowable variation range: 57 to 63 Hz) Main circuit power supply: Three-phase (3 wire) 380 to 500 V (Permissible AC voltage 323 to 550 V), 50 Hz (allowable variation range: 47.5 to 52.5 Hz) / 60 Hz (allowable variation range: 57 to 63 Hz)						
	Power supply capacity (kVA) *4)	VLD *8)	338	392	441	472	-	-	
		LD	310	358	405	436	499	599	
		ND	281	336	368	408	454	544	
Carrier frequency variation *5)	VLD *8)	0.5 to 8.0 kHz					-		
	LD	0.5 to 8.0 kHz							
	ND	0.5 to 10.0 kHz							
Starting torque *6)		180 % / 0.3 Hz							
Braking	Regenerative	External regenerative braking unit							
	Minimum resistance value (Ω)	-							
Dimensions *7)	H(height)(mm)	995	995	995	995	995	1200		
	W(width)(mm)	480	680	680	680	680	580		
	D(Depth)(mm)	370	370	370	370	370	450		
Protective structure		IP20 – UL Open Type							
Aprox. weight (kg)		95	125	125	125	125	170		

*1) Some models require current derating depending on the carrier frequency setting and ambient temperature. For details, please refer to "20.4 Current Derating". (Please contact us for models not described in the Basic / User's Guide.)

*2) The rated input current is the value when the drive is operated in the rated output current. The value of the impedance at the supply side changes due to the wiring, breaker, input reactor, etc. In addition, the input current on the specification label is a UL-certified current.

*3) Make sure the following for Low Voltage Directive (LVD) compliant.

- Pollution degree 2, - Overvoltage category 3 (for 380 to 460 Vac Input supply), - Overvoltage category 2 (for over 460 Vac Input supply)

*4) The power supply capacity is the value of the rated output current at 440V. The value of the impedance at the supply side changes due to the wiring, breaker, input reactor, etc.

*5) The setting range of carrier frequency [bb101] / [bb201] is limited according to the [Ub-03] setting (load type selection). It is recommended to set the carrier frequency settings [bb101] / [bb201] equal or greater than the (maximum output frequency x 10) Hz. For induction motor IM, it is recommended to set the carrier frequency to 2 kHz or more except V/f control. For synchronous motor (SM) / Permanent magnet motor (PMM), it is recommended to set the carrier frequency to 8 kHz or more.

*6) The value is specified for the Hitachi standard motor controlled by the sensorless vector control when ND rating. Torque characteristics may vary by the control system and the use of the motor.

*7) The key height of keypad are excluded from dimensions. When an option is connected, the depth is increased. Refer to the each option Guide.

*8) P1-05500-H (P1-2500H) and P1-06600-H (P1-3150H) support ND (normal duty) / LD (low duty) double rating.

20.2.3 Common Specifications

PWM system		Sine-wave PWM system		
Output frequency range *1)		0.00 to 590.00 Hz		
Frequency accuracy		For the highest frequency, digital $\pm 0.01\%$, analog $\pm 0.2\%$ ($25 \pm 10^\circ\text{C}$)		
Frequency resolution		Digital: 0.01Hz Analog: Ai1 terminal / Ai2 terminal:12 bit / 0 to +10 VDC or 0 to +20 mA, Ai3 terminal 12 bit / -10 to +10 VDC		
Control system *2)		IM V/f control (constant torque/reduced torque/ free / automatic torque boost control) V/f with encoder(constant torque/reduced torque/ free / automatic torque boost control) Cascade type sensorless vector control, 0Hz sensorless vector control, Vector control with encoder		
		SM/PM synchronous startup for smart sensorless vector control , IVMS start type sensorless vector control		
Speed fluctuation *3)		$\pm 0.5\%$ (sensorless vector control)		
Acceleration/deceleration time		0.00 to 3600.00 s (Linear, S-curve, U-curve, Inverted-U-curve, EL-S-curve)		
Display		Output frequency, Output current, Output torque, trip history, input/output terminal status, input/output terminal function, input/output power *4), PN voltage, etc, the others are described in Chapter 13.		
Start functions		DC braking after the start, Frequency matching after the start, Active frequency matching start, Low-voltage start, Retry restart.		
Stop functions		After free run stop, Deceleration stop, DC braking or external DC braking operation (Adjustable braking force, time and operating speed).		
Stall prevention function		Over load limit function, Over current suppression function, Over voltage suppression function.		
Protection functions *5)		Overcurrent error, Motor overload error, Braking resistor overload error, Overvoltage error, Memory error, Undervoltage error, Current detector error, CPU error, External trip error, USP error, Ground fault error, Power supply overvoltage error, Instantaneous power failure error, Temperature detector error, Cooling fan rotation speed reduction temperature error, Temperature error, Input open-phase error, IGBT error, Output open-phase error, Thermistor error, brake error, low-speed range overload error, Controller(inverter) overload error, RS485 communication error, RTC error, EzSQ related errors, Option related errors, Functional safety related errors, Encoder disconnection error, Position control range error, Speed deviation error, Position deviation error, Over-speed error, Contactor error, Feedback option connection error, PID start error.		
Other functions		V/f free setting (7 points), upper and lower speed limit, speed jump, curve acceleration and deceleration, manual torque boost, energy-saven operation, analog output adjustment, minimum speed, carrier frequency adjustment, motor electronic thermal function(free is possible), inverter thermal function, analog input adjustment, frequency input selection, trip retry, restart stop, various signal output, inilization setting, PID control, auto-decel at shut-off, brake control function, commercial power switching function, auto-tuning (online / offline), etc. The other functions are described in Chapter 12		
Input	Frequency reference	Keypad	The parameters for the command value (Set by operating the arrow keys on the keypad)	
		External signal *6)	Ai1 / Ai2 terminal (for voltage input)	0 to 10 VDC set by the voltage input (Input impedance:10 k Ω)
			Ai1 / Ai2 terminal (for current input)	0 to 20 mA set by the current input (Input impedance:100 Ω)
			Ai3 terminal	-10 to +10 VDC set by the voltage input (Input impedance:10 k Ω)
			Multi-speed terminal	16 multi-speed (With the use of the intelligent input terminal)
	Pulse train-input	Maximum 32 kHz \times 2		
	RUN/Stop Forward/Reverse	Communication port	RS485 serial communication (Protocol: Modbus-RTU)	
		Keypad	RUN/Stop key (With the set parameter, forward/reverse can be switched)	
		External signal	Forward (FW)/ Reverse(RV)/ 3-wire input (When input terminal functions are allocated)	
	Communication Port	Set by RS485 communication (Maximum: 115.2kbps)		
Intelligent input terminals	11 terminals (A or B terminal accept a pulse train) FW(Forward rotation)/RV(Reverse rotation), CF1 to CF4(Multi speed 1 to 4), SF1 to SF7(Multi speed Bit 1 to 7), ADD(Trigger for frequency addition), SCHG(Main/Sub speed reference change), STA(3-wire start)/STP(3-wire stop) / F/R(3-wire Forward/Reverse), AHD(Analog command holding), FUP(Remote speed up)/FDN(Remote speed down) / UDC(Remote speed data clearing), F-OP(Force operation), SET(2nd-motor), RS(Reset), JG(Jogging), DB(External DC braking), 2CH(2-stage Accel/Decel), FRS(Free-run stop), EXT(External fault), USP(Unattended start protection), CS(Commercial power supply change), SFT(Soft lock), BOK(Answer back from Brake), OLR(Overload restriction selection), KHC(Accumulation input power clearance), OKHC(Accumulation output power clearance), PID to PID4(PID1 to PID4 disable), PIDC to PIDC4(PID1 to PID4 integration reset), SVC1 to 4(PID1 Multi set-point 1 to 4), PRO(PID gain change), PIO1/2(PID output switching 1/2), SLEP(SLEEP condition activation) / WAKE(WAKE condition activation), TL(Torque limit enable), TRQ1/2(Torque limit selection1/2), PPI(P/PI control mode selection), CAS(Control gain change), SON(Servo-ON), FOC(Forcing), ATR(Permission of torque control), TBS(Torque bias enable), ORT(Home search function), LAC(Accel/Decel cancellation), PCLR(Clearance of position deviation), STAT(Pulse train position reference input enable), PUP(Position bias (ADD)), PDN(Position bias (SUB)), CP1 to CP4(Multistage position 1 to 4), ORL(Limit signal of Homing), ORG(Start signal of Homing), FOT(Forward over travel), ROT(Reserve over travel), SPD(Speed/position switching), PSET(Position data presetting), Mi1 to 11 (General-purpose input 1 to 11), PCC(Pulse counter clearing), ECOM(EzCOM activation), PRG(Program RUN), HLD(Accel/Decel disable), REN(RUN enable), DISP(Display lock), PLA(Pulse count A), PLB(Pulse count B), EMF(Emergency-force drive activation), COK(Contactor check), DTR(Data trace start), PLZ(Pulse train input Z), TCH(Teach-in)			
Backup supply terminal	P+/P-: 24 VDC input (Input allowable voltage: 24 VDC \pm 10%)			
Functional safety STO input terminal	2 terminals (Simultaneous input)			
Thermistor input terminal	1 terminal (PTC/NTC resistor allowed)			

*1) Output frequency range will depend on the motor control method and the motor used. Consult the motor manufacturer for the maximum allowable frequency of the motor when operating beyond 60Hz.

*2) In case of the control mode is changed and the motor constant is not set appropriately, the desired starting torque cannot be obtained and also exists the possibility of tripping.

*3) Regarding the speed range regulation of motor, the variable range depends on the client system and the environment in which the motor is used. Please contact Hitachi inverter distributors for more information.

*4) Both the input power and output power are reference values, which are not appropriate for use in calculation of efficiency values, etc. To obtain an accurate value, use an external device.

*5) If the IGBT error [E030] occurs by the protective function, it may have happened by the short-circuit protection, but also can occur if the IGBT is damaged. Depending on the operation status of the inverter, instead of the IGBT error, the overcurrent error [E001] may also occur.

*6) At factory setting, the maximum output frequency for analog input signal Ai1/Ai2 is adjusted to 9.8 VDC for voltage input and 19.8 mA for current input. To change characteristic, refer to the adjustment parameter [Cb-01] to [Cb-35] of analog input terminal of this Guide.

Common Specifications(Continued)

Output	Intelligent output terminals	Transistor output terminal 5, 1a contact relay 1 point, 1c contact relay 1 point	
	Relay/ Alarm relay (1a, 1c) function	RUN(Running), FA1 to 5(Frequency reached signals), IRDY(Inverter ready), FWR(Forward rotation), RVR(Reverse rotation), FREF(Frequency reference = Keypad is selected), REF(Run command = Keypad is selected), SETM(2nd-motor selected), OPO(Option Output), AL(Alarm), MJA(Major failure), OTQ(Over torque)*7), IP(Instantaneous power failure), UV(Undervoltage), TRQ(Torque limited), IPS(IP-Non stop function is active), RNT(Accumulated RUN time over), ONT(Accumulated power-on time over), THM(Electronic thermal alarm (Motor)), THC(Electronic thermal alarm (Inverter)), WAC(Capacitor life warning), WAF(Cooling-fan speed drop), FR(RUN command active), OHF(Heat sink overheat warning), LOC/LOC2(Low-current indication 1/2), OL/OL2(Overload warning notice 1/2), BRK(Brake release), BER(Brake error), CON(Contactor control), ZS(Zero speed detection), DSE(Speed deviation over), PDD(Position deviation over), POK(Positioning completed), PCMP(Pulse counter compare match output), OD/OD2/OD3/OD4(Over deviation for PID1 to 4 control), FBV/FBV2/FBV3/FBV4(PID1 to 4 feedback comparison), NDc(Communication line disconnection), Ai1Dc/Ai2Dc/Ai3Dc/Ai4Dc/Ai5Dc/Ai6Dc(Analog Ai1 to Ai6 disconnection detection), WCAi1/WCAi2/WCAi3/WCAi4/WCAi5/WCAi6 (Window comparator Ai1 to Ai6), LOG1 to 7(logical operation result 1 to 7), MO1 to 7(General-purpose output 1 to 7), EMFC(Emergency force drive indicator), EMBP(Bypass mode indicator), WFT(Trace function waiting for trigger), TRA(Trace function data logging), LBK(Low battery of keypad), OVS(Overvoltage power Supply), AC0 to 3(Alarm code bit-0 to 3), SSE(PID soft start error)	
	EDM output terminal	Functional safety diagnostic output	
	Output terminal monitor *8)	The data of the monitor can be selected by the parameter of the output	
EMC filter *9)		EMC filter can be enable (The filter exchange method can alter depending on the model)	
PC external access		USB Micro-B	
Operating environment	Ambient temperature *14)	ND	-10 to 50°C
		LD	-10 to 45°C
		VLD	-10 to 40°C
	Storage temperature *10)	-20 to 65°C	
	Level of humidity	20 to 90%RH(No condensation allowed)	
Vibration tolerance *11)	5.9 m/s ² (0.6G), 10 to 55 Hz	P1-00044-L(P1-004L) to P1-01240-L(P1-220L)/P1-00041-H(P1-007H) to P1-00620-H(P1-220H)	
	2.94 m/s ² (0.3G), 10 to 55Hz	P1-01530-L(P1-300L) to P1-03160-L(P1-550L)/P1-00770-H(P1-300H) to P1-06600-H(P1-3150H)	
Installation place *12)	1000 altitude or lower (location free from corrosive gas, oil mist, and dust)		
Components life span	The design life of the electrolytic capacitor on the board and the main circuit smoothing capacitor is 10 years.		
	The design life of the cooling fan is 10 years (models with cooling fan). But no dust.		
	Non-volatile memory parts on control circuit board.		
Conformity standars *13)	The design life of the LCD backlight in Keypad (VOP) is 10 years(8hr/day at 100% dimming, 30% brightness reduction)		
	UL, cUL, CE marking, RCM, Functional safety (STO function/ IEC61800-5-2,IEC62061,IEC61508: SIL3/ EN ISO13849-1: Cat.4 PLe) The functional safety certification models are P1-00044-L(P1-004L) to P1-02950-L(P1-550L) / P1-00041-H(P1-007H) to P1-03160-H(P1-1320H). In addition, the certification models for the functional safety option P1-FS are also the same models.		
Coating color	Black (P1-1600HFF and above models are unpainted (but front cover and terminal block cover are black))		
Optional slots	3 ports		
Option cassettes *15)	· Communication option : Ethernet(Modbus-TCP)(P1-EN), EtherCAT® (P1-ECT), PROFINET® (P1-PN), PROFIBUS® (P1-PB), CC-Link® (P1-CCL), DeviceNet® (P1-DN)		
	· Encoder Feedback option (Line driver input(RS422))(P1-FB) · Functional safety option(P1-FS)(STO/SS1/SBC/SLS/SDI/SSM function/IEC61800-5-2,IEC62061, IEC61508:SIL3/EN ISO13849-1:Cat.4 PLe) · Analog input/output option (P1-AG)		
Other optional components	Braking resistor, AC reactor, DC link choke, Noise filter, Operator cable, Harmonics suppression unit, LCRfilter, Analog panel, Regenerative braking unit, Power regeneration converter, SJ300/L300P/SJ700/L700 compatible screw type control terminal block option(P1-TM2 / P1-TM2R), PC software ProdriveNext.		

*7) The threshold for signal output varies depending on the motor to be combined with the inverter, parameter adjustment, etc.

*8) The analog voltage and analog current monitor are estimated outputs of the analog meter connection. Maximum output value might deviate slightly from 10V or 20mA by variation of the analog output circuit. If you want to change the characteristics, adjust the Ao1 and Ao2 adjustment functions. There are some monitor data that cannot be output.

*9) In order to enable the EMC filter, connect to the neutral grounding supply. Otherwise, the leakage current may increase.

*10) Storage temperature is the temperature during transport.

*11) In accordance with the test methods of JIS C 60068-2-6:2010(IEC 60068-2-6:2007).

*12) In case of utilization at an altitude of 1000m or more, take into account that the atmospheric pressure is reduced by 1% for every 100m up. Apply 1% current derating from the rated current by increasing every 100m, and conduct an evaluation test. When using above 2500m ambient, please contact Hitachi Inverter distributor.

*13) Insulation distance is in accordance with the UL and CE standards.

*14) Use the 400V class inverter at an input voltage of 500VAC or below. If input voltage exceeds 500VAC due to fluctuation of power, use the inverter at 40°C or lower ambient temperature.

*15) Modbus® is a registered trademark of Schneider Automation Inc.

EtherCAT® is registered trademark and patented technology, licensed by Beckhoff Automation GmbH, Germany.

PROFIBUS® and PROFINET® is registered trademark of PROFIBUS Nutzerorganisation e.V. (PNO).

CC-Link® is trade names of Mitsubishi Electric Co. DeviceNet® is the trademark of Open DeviceNet Vendor Association, Inc.

20.3 External Dimensions

Model P1-****-*(P1-****)			
200 V class: 00044-L (004L), 00080-L (007L), 00104-L (015L), 00156-L (022L) , 00228-L (037L)			
400V class: 00041-H (007H), 00054-H (015H), 00083-H (022H), 00126-H (037H)			
Dimension	W (mm)	H (mm)	D (mm)
	150	255	140

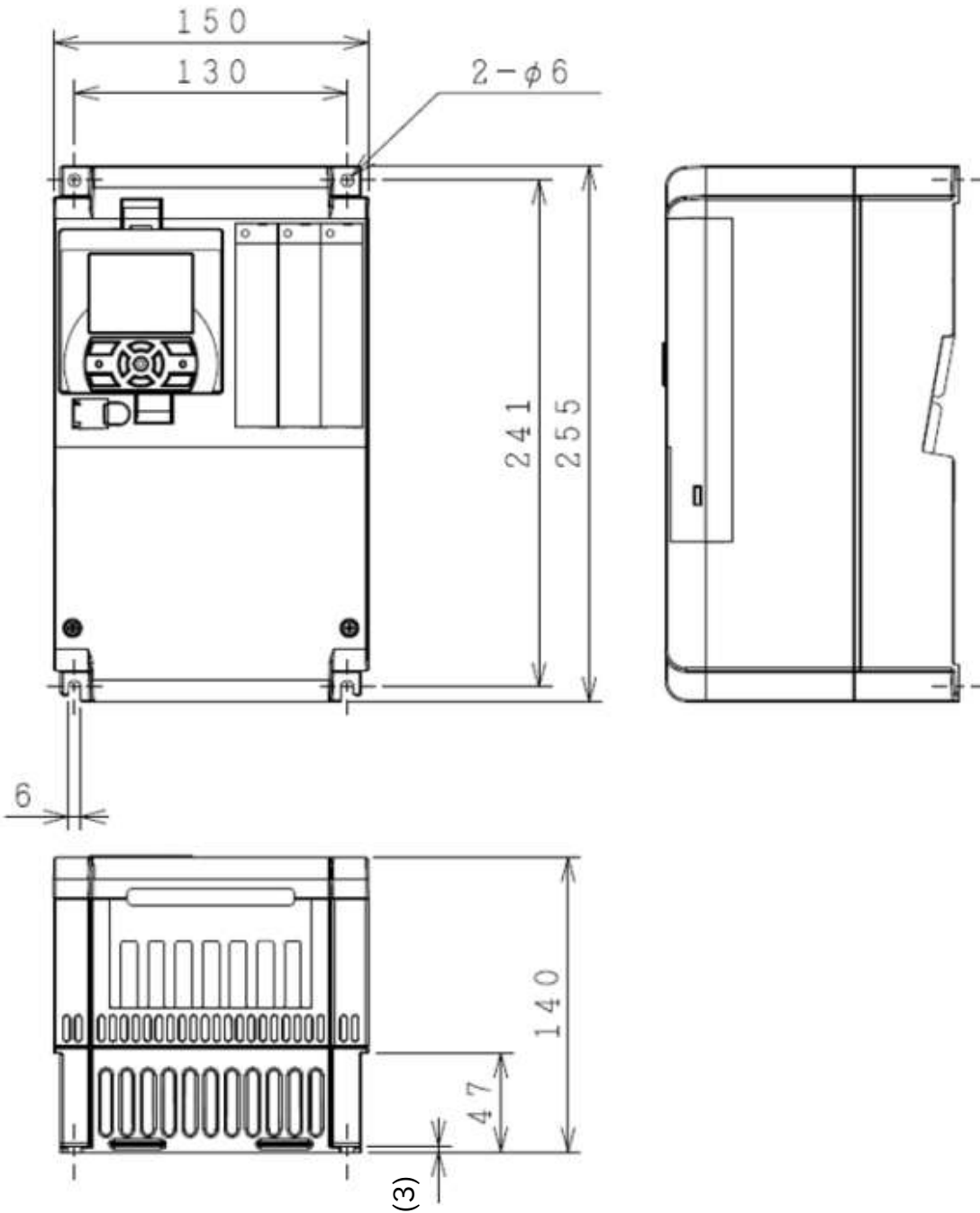

Model P1-****-* (P1-****)			
200V class: 00330-L (055L), 00460-L (075L), 00600-L (110L)			
400V class: 00175-H (055H), 00250-H (075H), 00310-H (110H)			
Dimension	W (mm)	H (mm)	D (mm)
	210	260	170

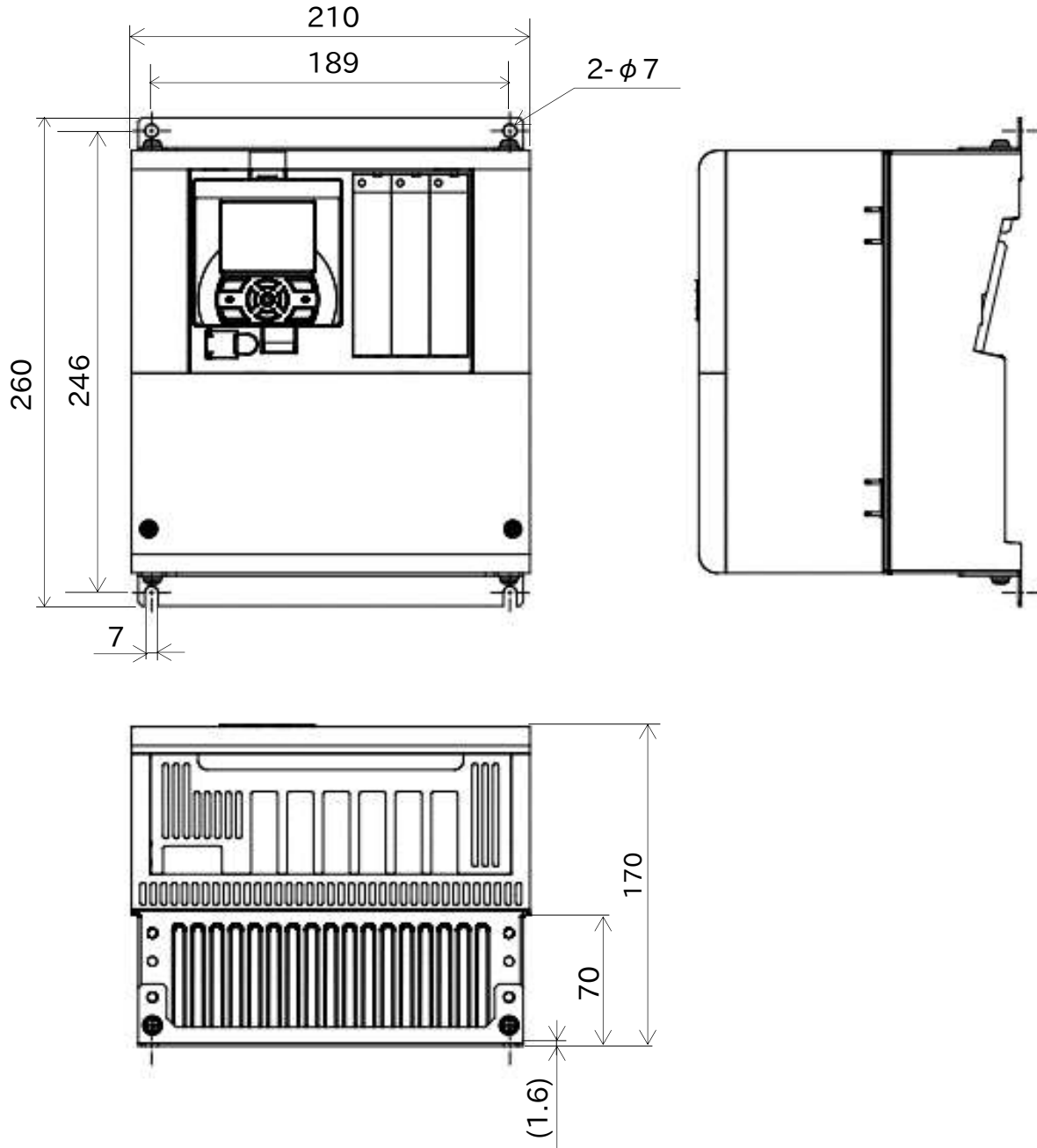

Model P1-*****(P1-****)			
200V class: 00800-L (150L), 00930-L (185L), 01240-L (220L)			
400V class: 00400-H (150H), 00470-H (185H), 00620-H (220H)			
Dimension	W (mm)	H (mm)	D (mm)
	245	390	190

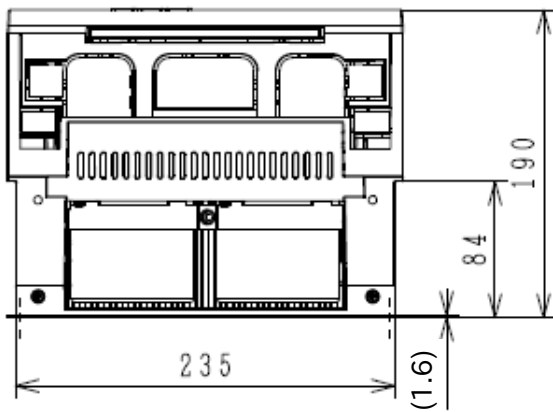
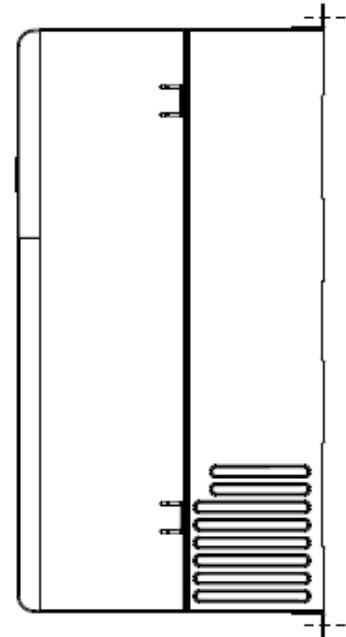
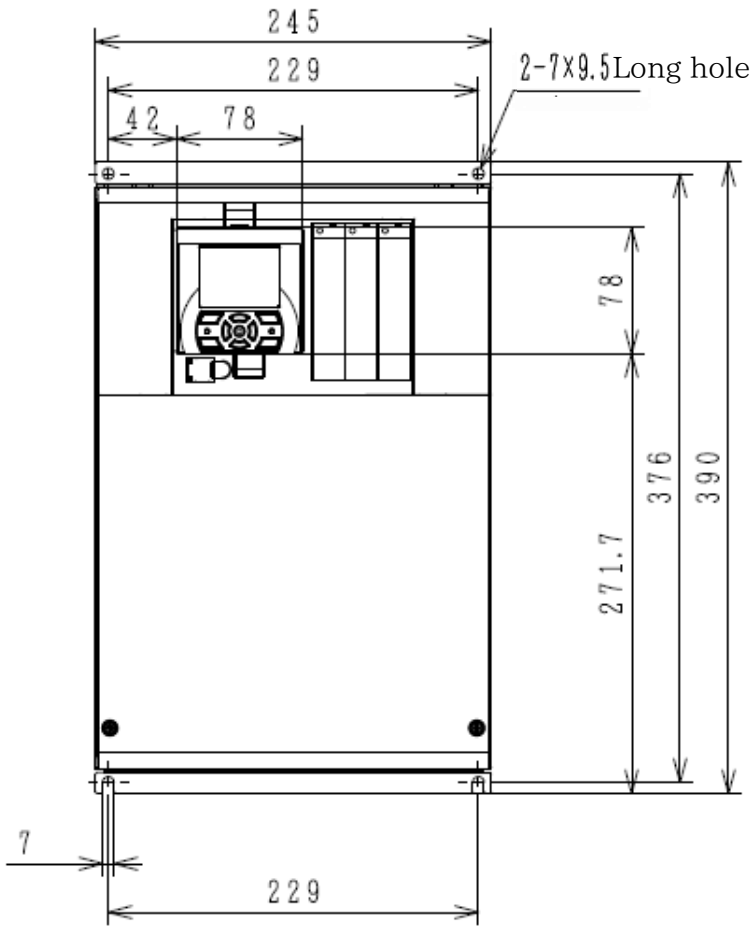

Model P1-****-*(P1-****)			
200V class: 01530-L (300L)			
400V class: 00770-H (300H)			
Dimension	W (mm)	H (mm)	D (mm)
	300	540	195

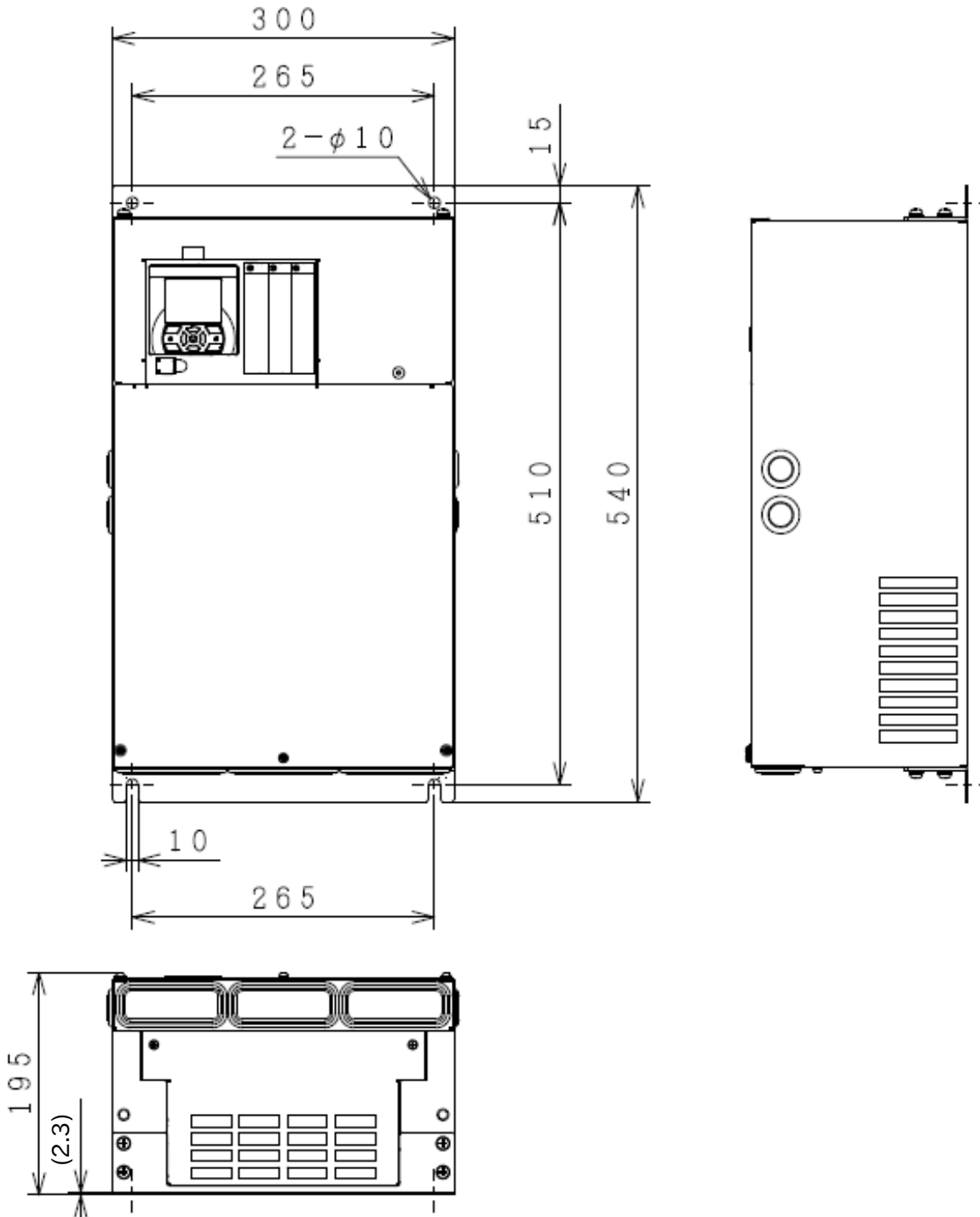

Model P1-*****(P1-****)			
200V class: 01850-L (370L), 02290-L (450L)			
400V class: 00930-H (370H), 01160-H (450H), 01470-H (550H)			
Dimension	W (mm)	H (mm)	D (mm)
	390	550	250

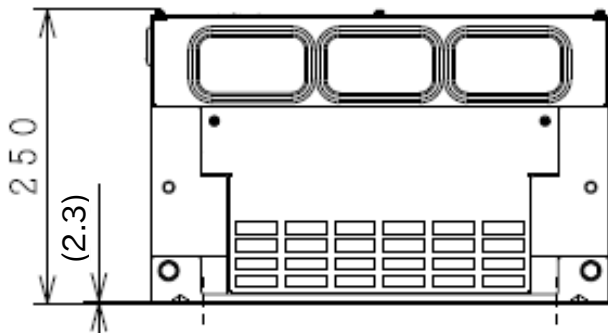
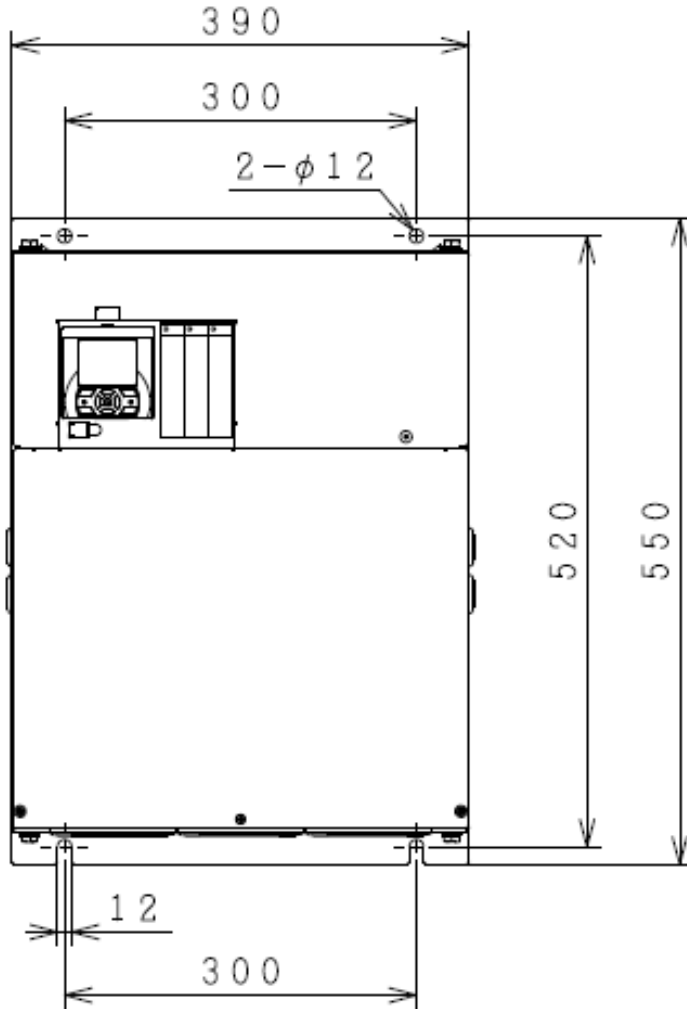

Model P1-****-* (P1-****)			
200V class: 02950-L (550L)			
Dimension	W (mm)	H (mm)	D (mm)
	480	700	250

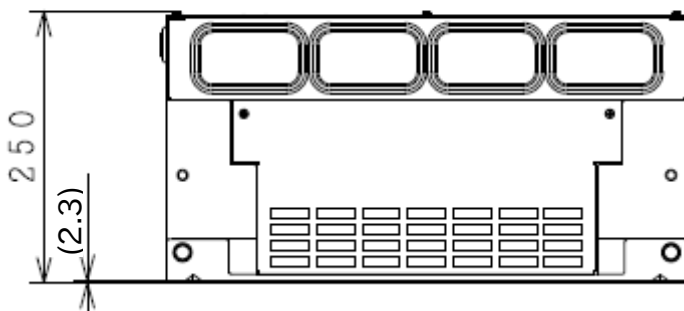
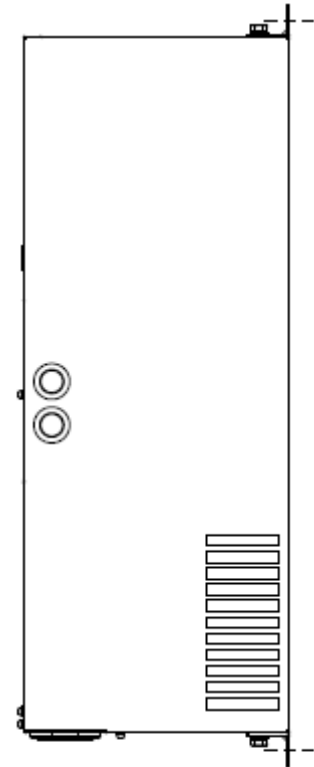
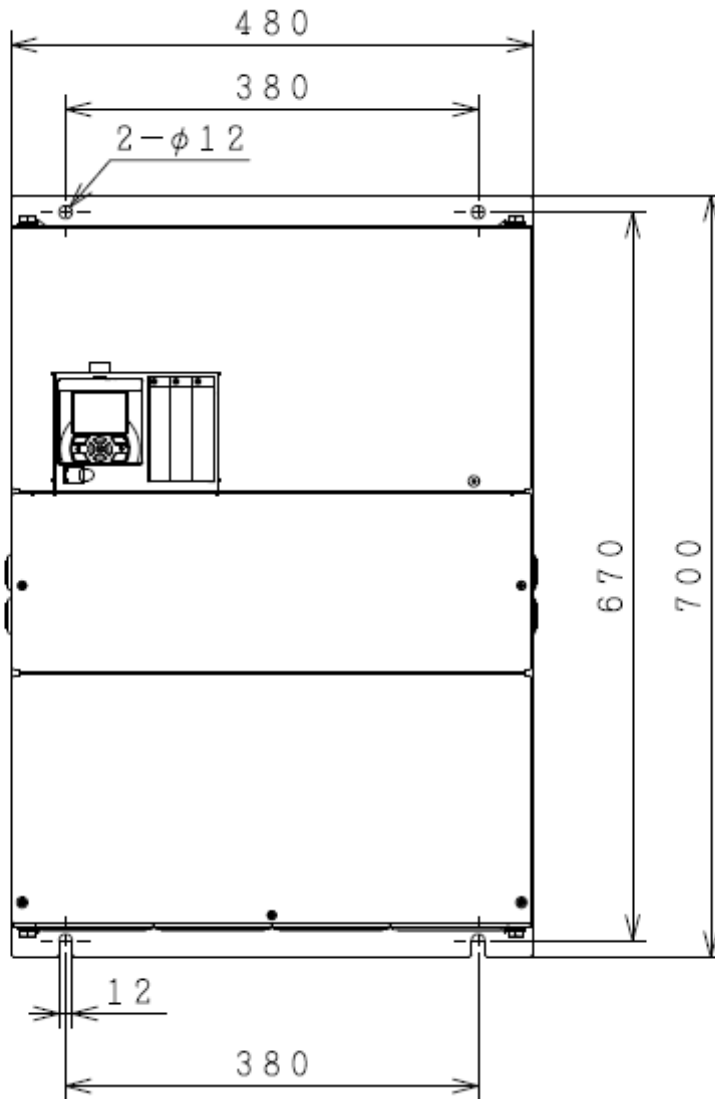

Model P1-****-*(P1-****)			
400V class: 01760-H (750H), 02130-H (900H)			
Dimension	W (mm)	H (mm)	D (mm)
	390	700	270

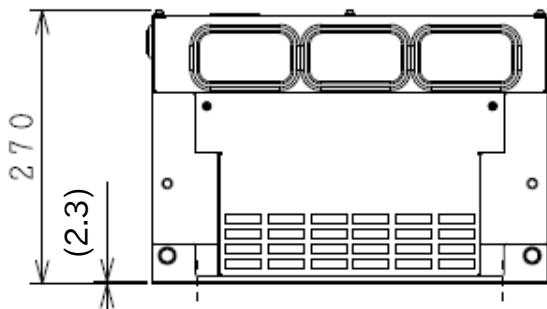
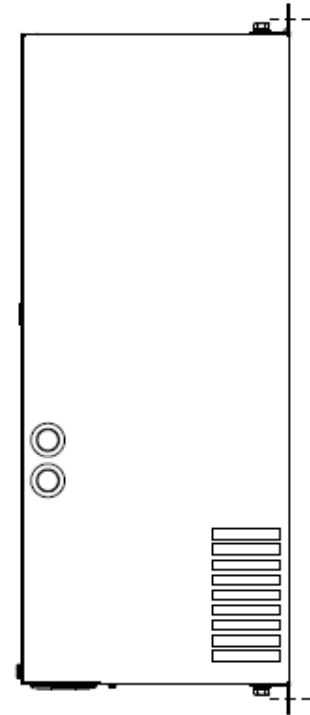
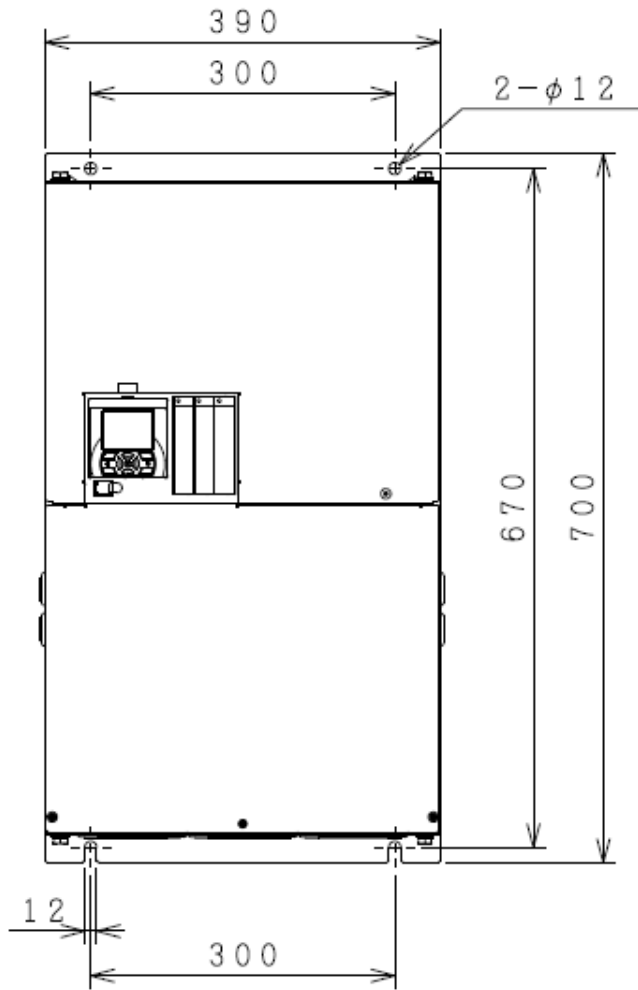

Model P1-****-* (P1-****)			
400V class: 02520-H (1100H), 03160-H (1320H)			
Dimension	W (mm)	H (mm)	D (mm)
	480	740	270

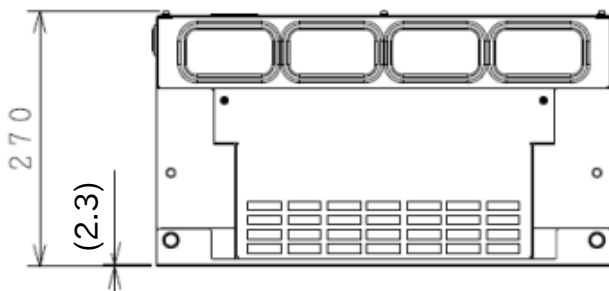
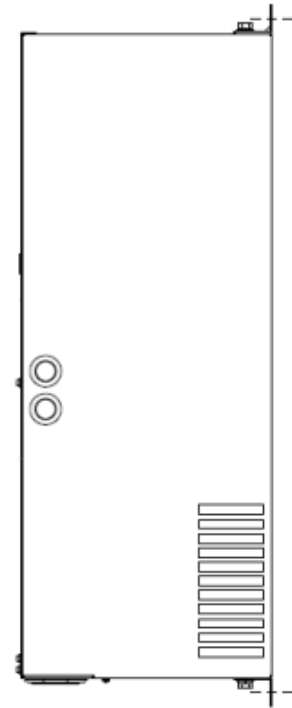
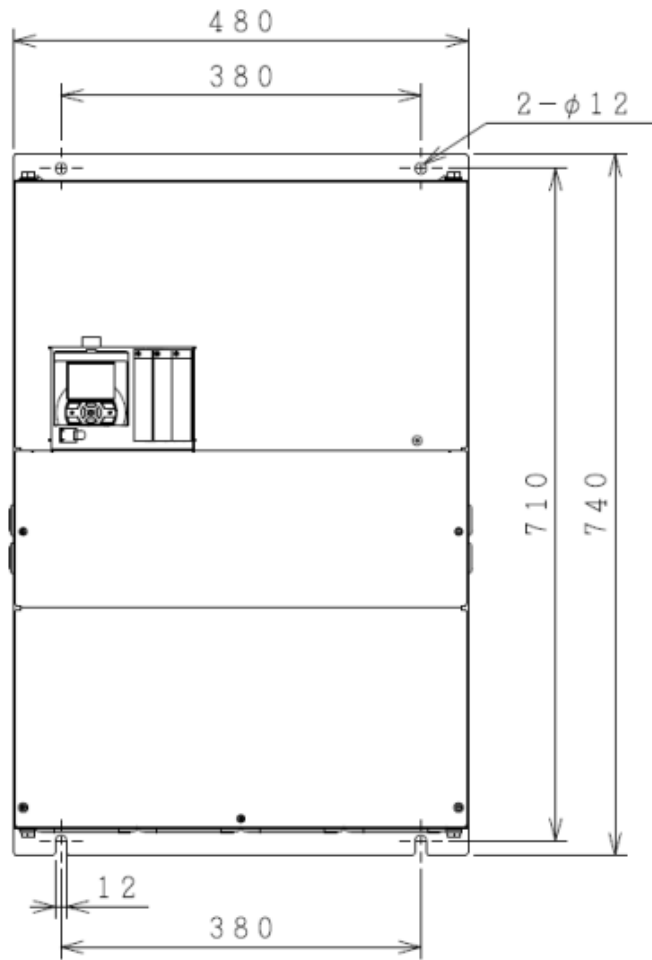

Model P1-****-* (P1-****)			
400V class:03720-H (1600H)			
Dimension	W(mm)	H(mm)	D(mm)
	480	995	370

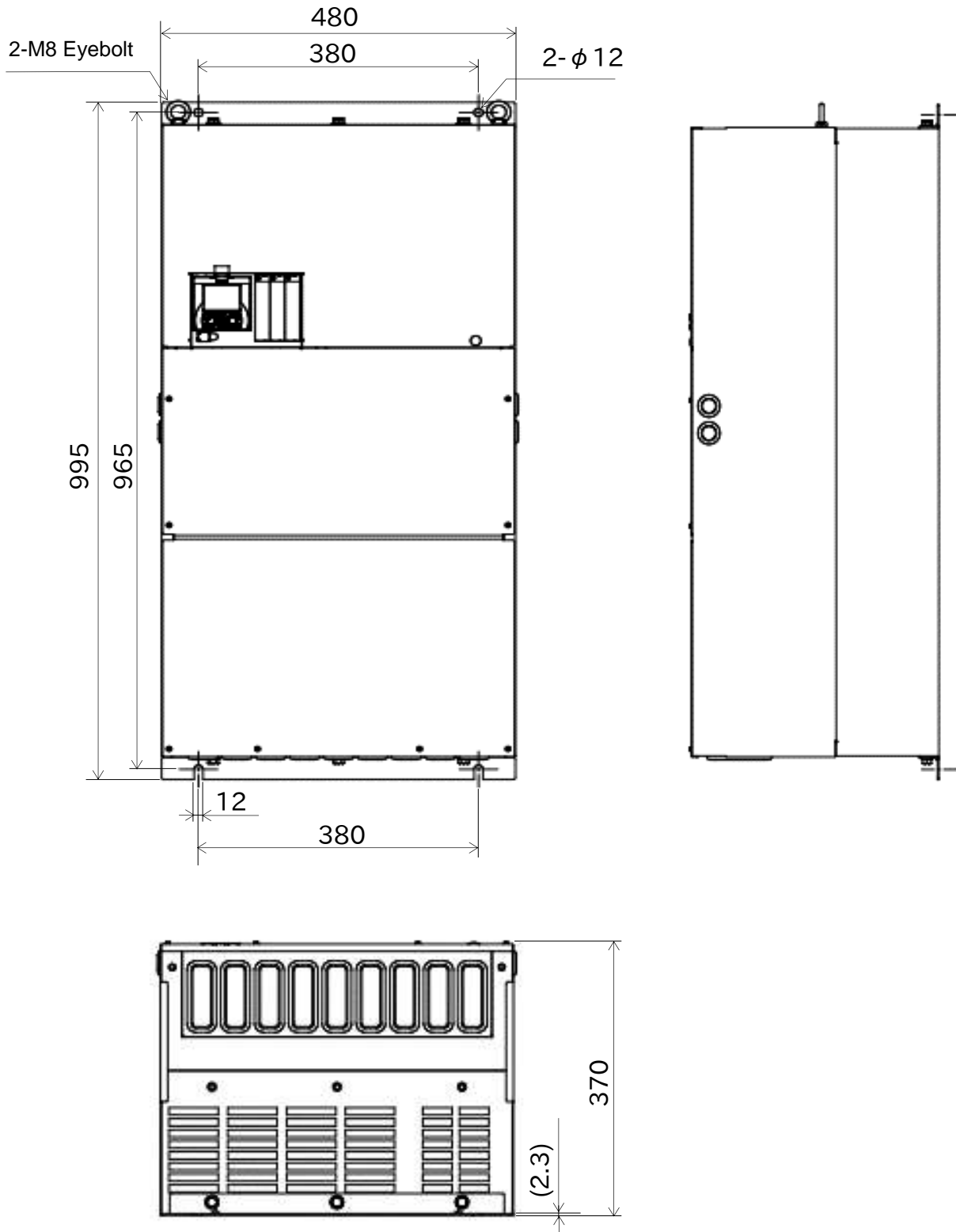

Model P1-****-* (P1-****)			
400V class:04320-H (1850H)			
Dimension	W(mm)	H(mm)	D(mm)
	680	995	370

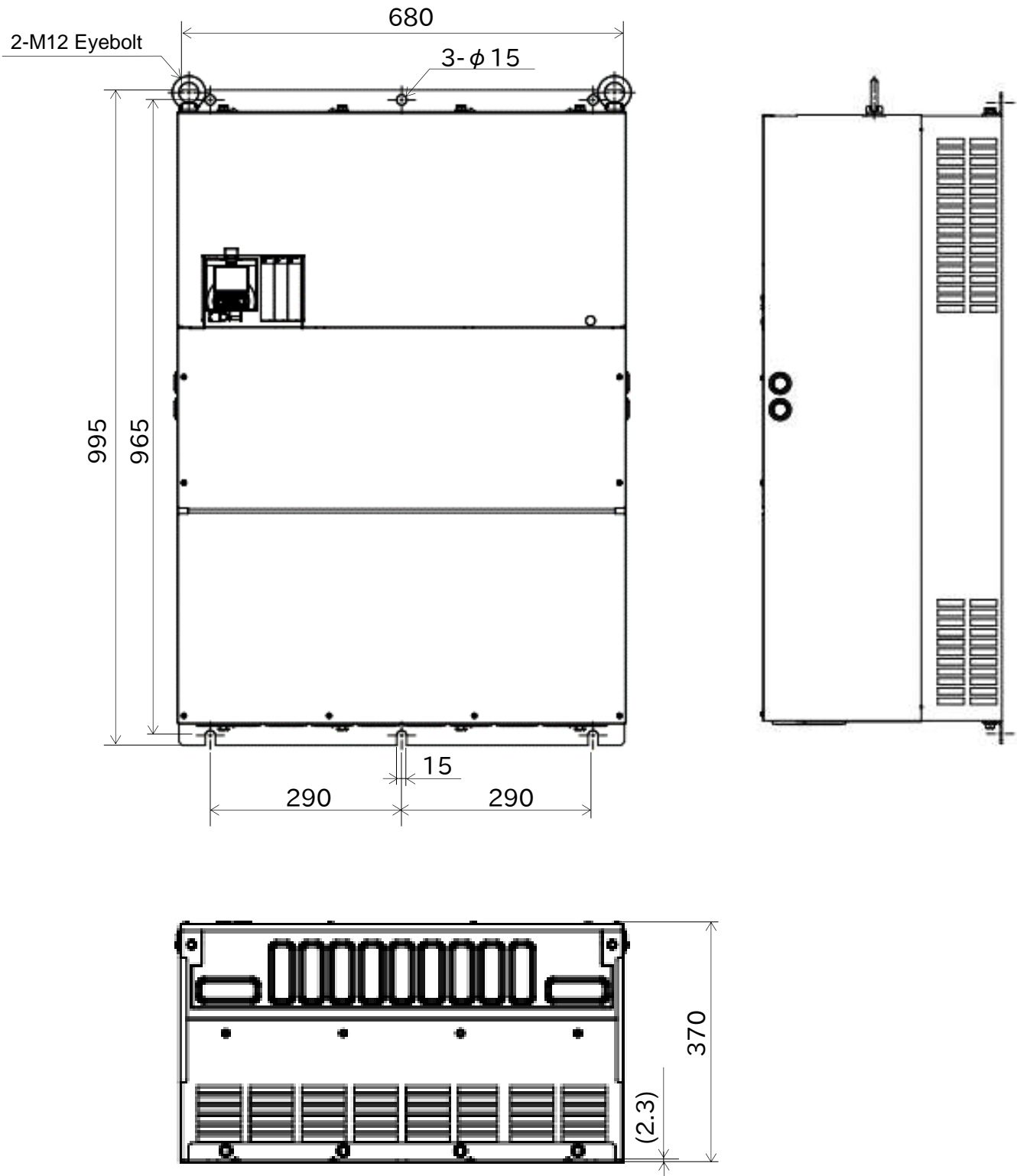

Model P1-****-* (P1-****)			
400V class:04860-H (2000H), 05200-H (2200H), 05500-H (2500H)			
Dimension	W(mm)	H(mm)	D(mm)
	680	995	370

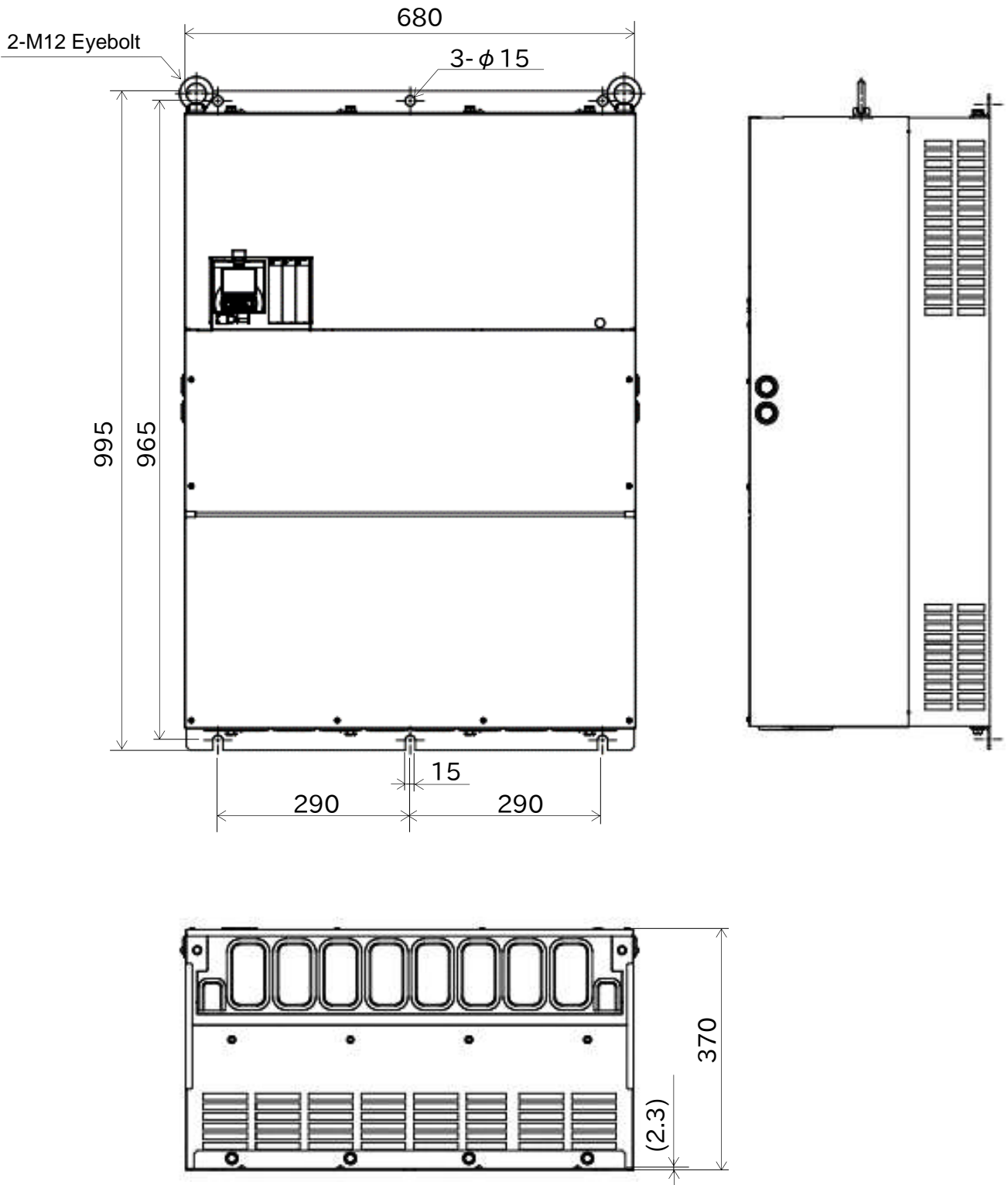

Model P1-****_* (P1-****_*)			
400V class:06600-H (3150H)			
Dimension	W(mm)	H(mm)	D(mm)
	580	1200	450

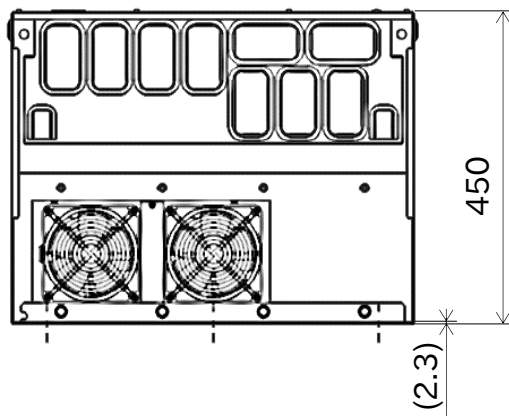
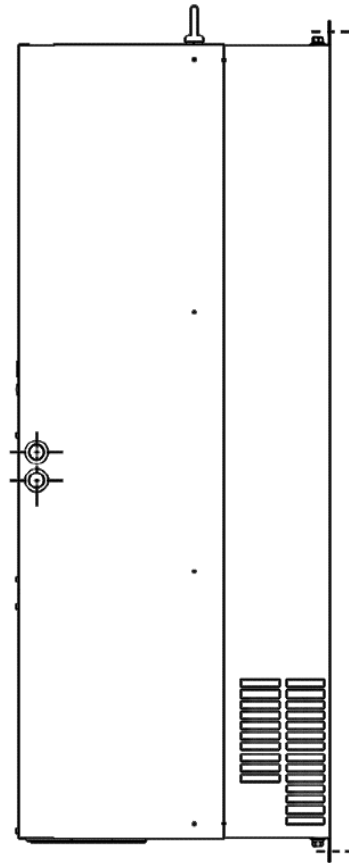
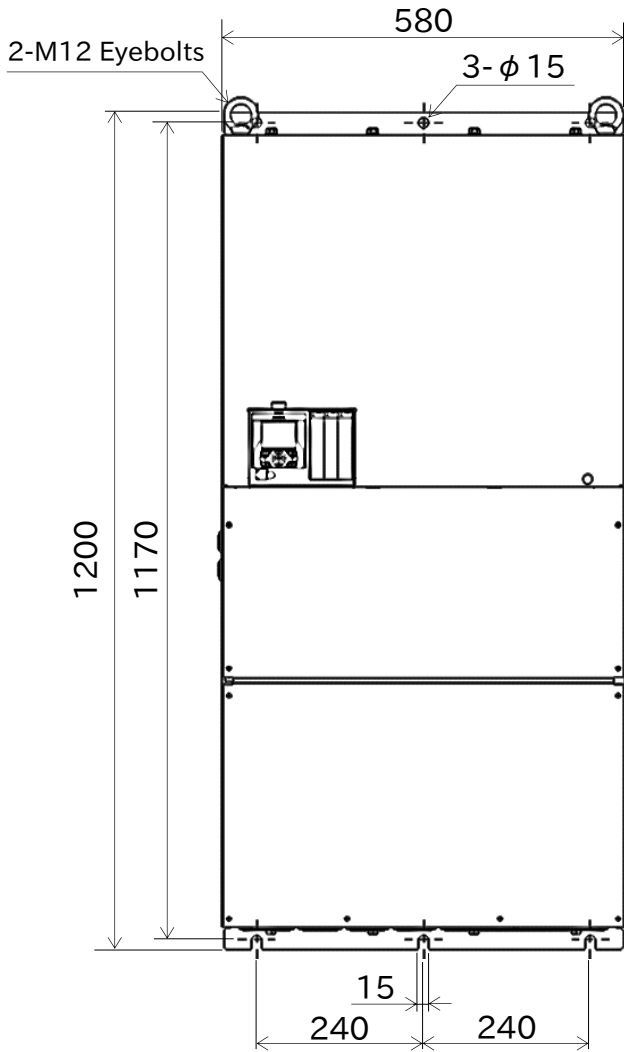

20.4 Current Derating



Please use the inverter within the current range in accordance with the derating curves of each model. If using exceeding the derating range, the Motor overload error [E005] or the Controller(Inverter) overload error [E039] may be occurred. And note that the inverter may be damaged or its life may be shortened depending on the usage conditions.

Also, please note that the ND rated current derating is applied to the electronic thermal protection of the inverter regardless of the Load type selection [Ub-03] setting. Therefore, even if [Ub-03] is changed to LD or VLD, check not only LD or LVD but also ND rated current derating. For details, see "12.7.1 Electronic Thermal Setting of Motor" and "12.19.9 Outputting a Warning Before Thermal Protection of the Inverter", and for handling each error, see "Chapter 18 Tips/FAQ/Troubleshooting" for these errors.

20.4.1 200V Class

■P1-00044-L (P1-004L)
Current derating is not required.

■P1-00080-L (P1-007L)
Current derating is not required.

■P1-00104-L (P1-015L)
Current derating is not required.

■P1-00156-L (P1-022L)
Current derating is not required.

■P1-00228-L (P1-037L)

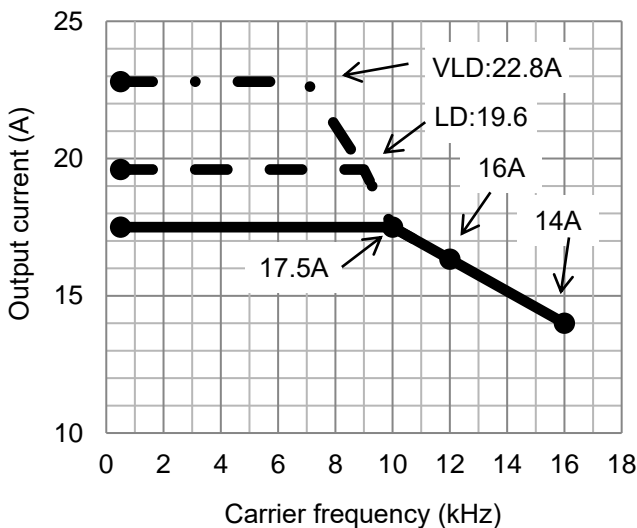

- 50°C: ND rating (normal duty rating)
 - - -● 45°C: LD rating (low duty rating)
 - · - ·● 40°C: VLD rating (very low duty rating)
- P1-00330-L (P1-055L)

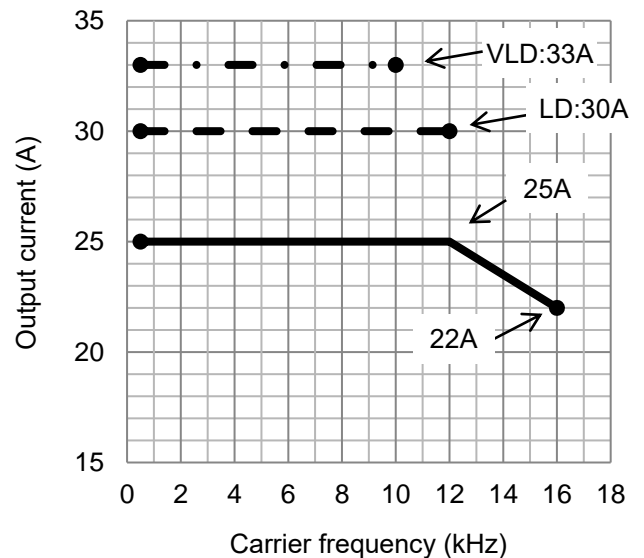

■P1-00460-L (P1-075L)

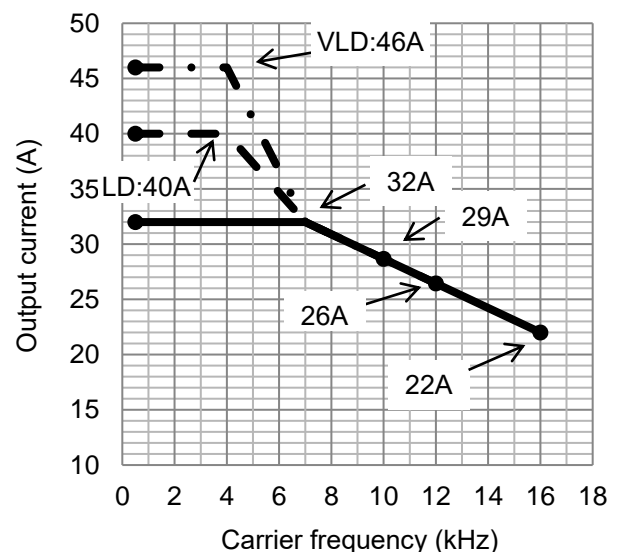

- 50°C: ND rating (normal duty rating)
- - -● 45°C: LD rating (low duty rating)
- · - ·● 40°C: VLD rating (very low duty rating)

■P1-00600-L (P1-110L)

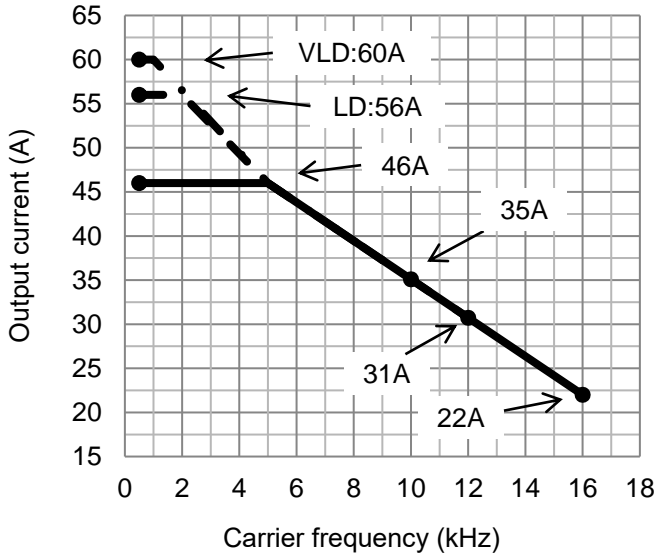

When using P1-00600-L (P1-110L) at LD (low duty rating) / VLD (very low duty rating), care must be taken for installation. See notes described in "6.3 External Dimensions".

■P1-00800-L (P1-150L)

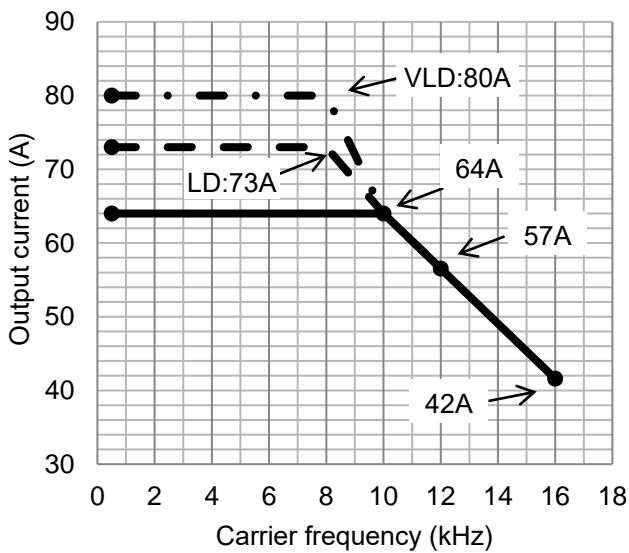

■P1-00930-L (P1-185L)

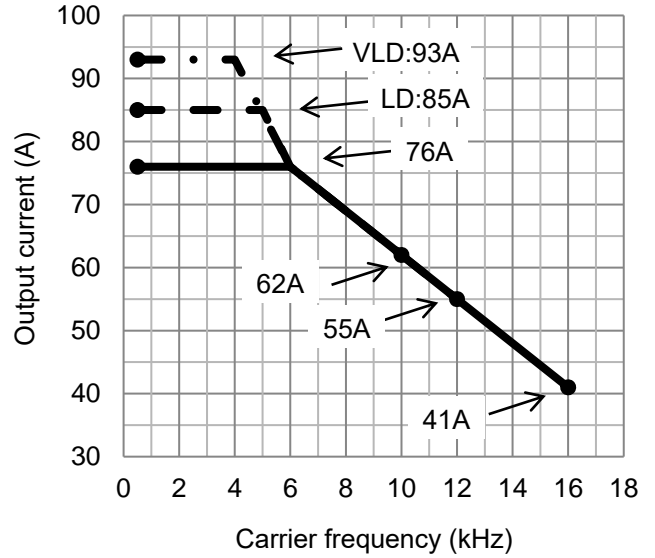

■P1-01240-L (P1-220L)

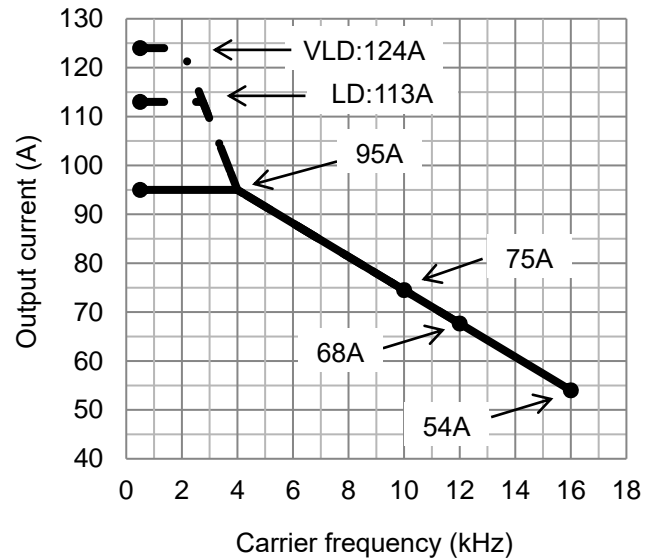

When using P1-01240-L (P1-220L) at VLD (very low duty rating), care must be taken for installation. See notes described in "6.3 External Dimensions".

- 50°C: ND rating (normal duty rating)
- - -● 45°C: LD rating (low duty rating)
- · - ·● 40°C: VLD rating (very low duty rating)

■P1-01530-L (P1-300L)

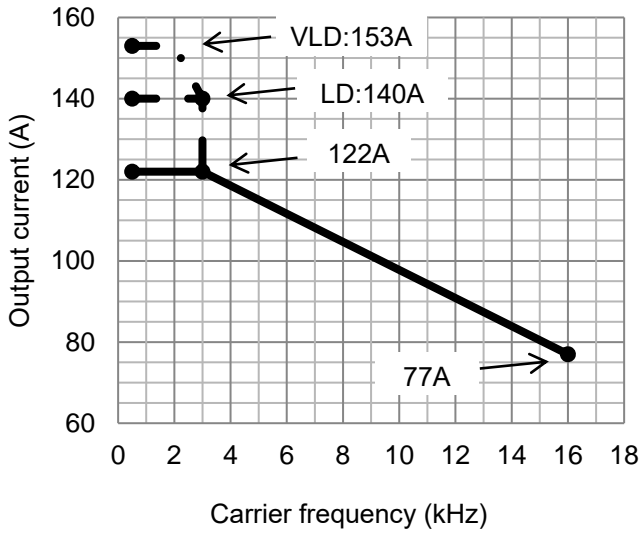

■P1-02290-L (P1-450L)

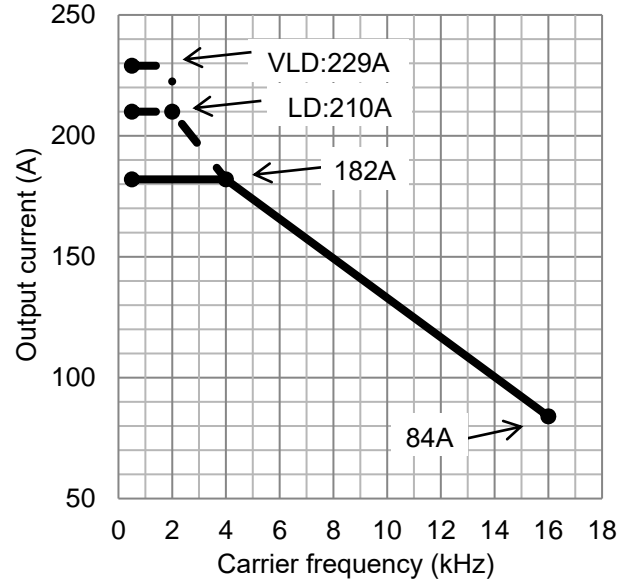

■P1-01850-L (P1-370L)

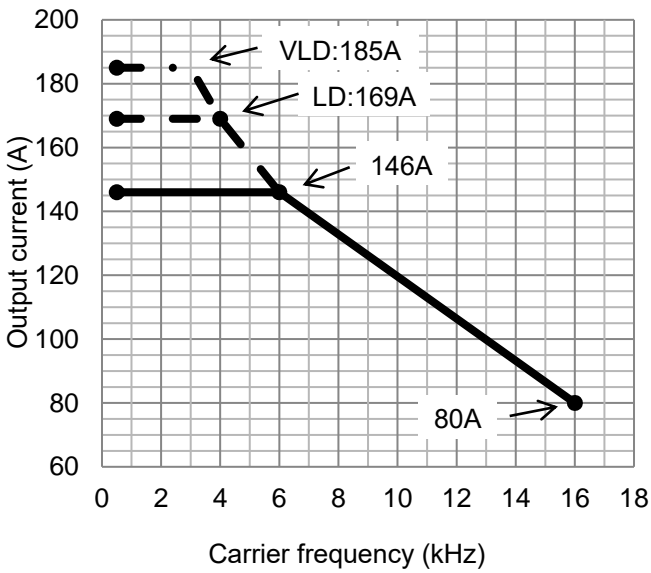

■P1-02950-L (P1-550L)

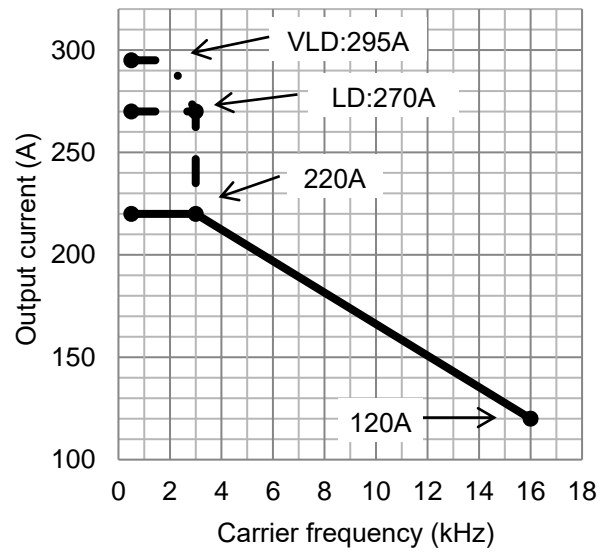

20.4.2 400V Class

- 50°C: ND rating (normal duty rating)
- - -●- - - 45°C: LD rating (low duty rating)
- · · - - -●· · · 40°C: VLD rating (very low duty rating)

■ P1-00041-H (P1-007H)

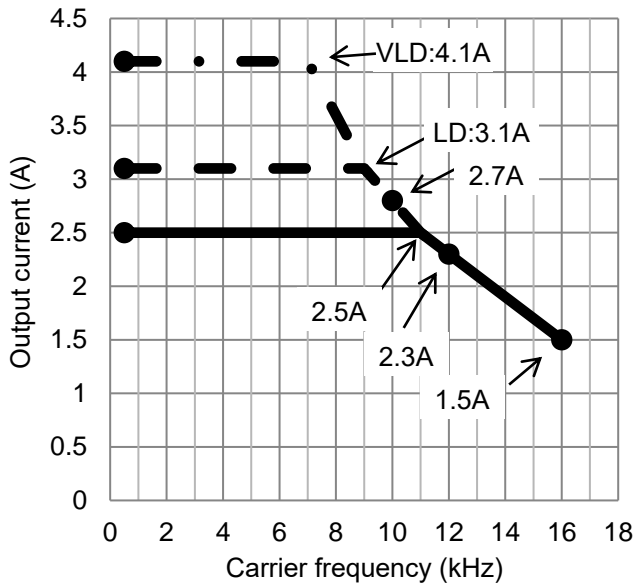

■ P1-00083-H (P1-022H)

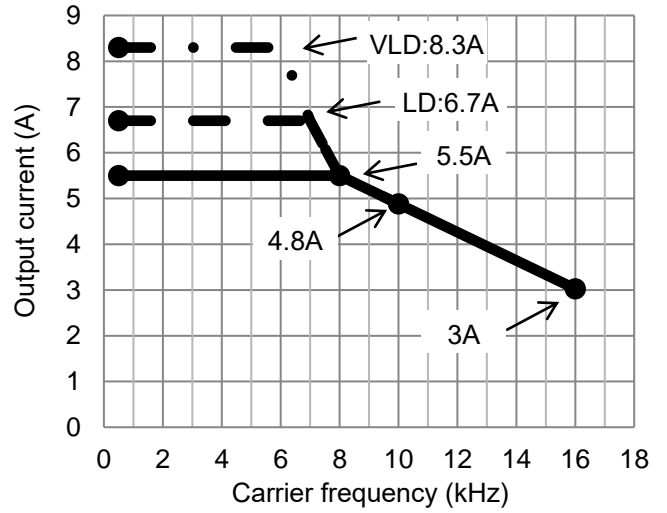

■ P1-00054-H (P1-015H)

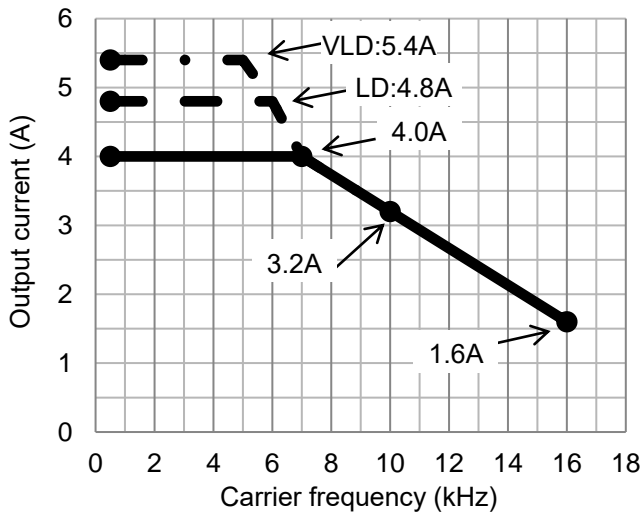

■ P1-00126-H (P1-037H)

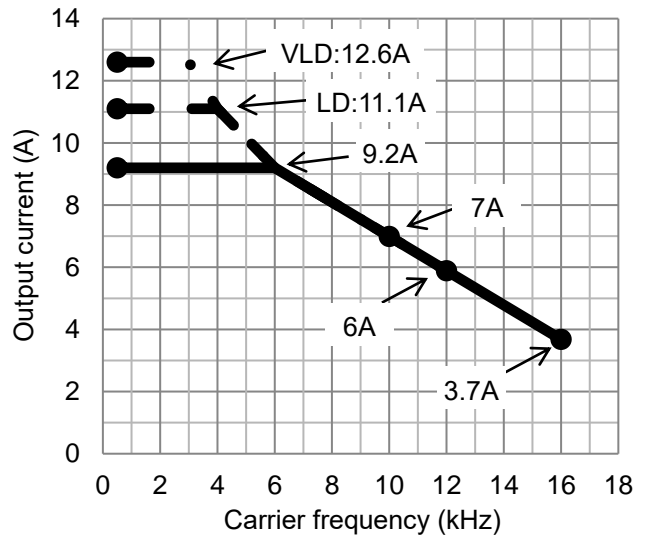

- 50°C: ND rating (normal duty rating)
- - -● 45°C: LD rating (low duty rating)
- · - ·● 40°C: VLD rating (very low duty rating)

■P1-00175-H (P1-055H)

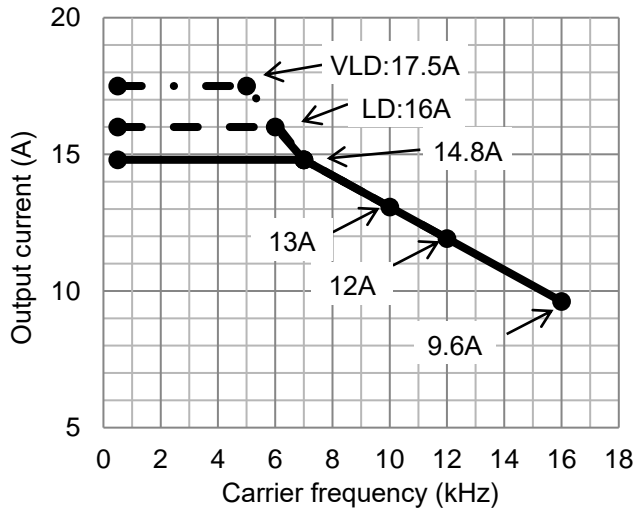

■P1-00310-H (P1-110H)

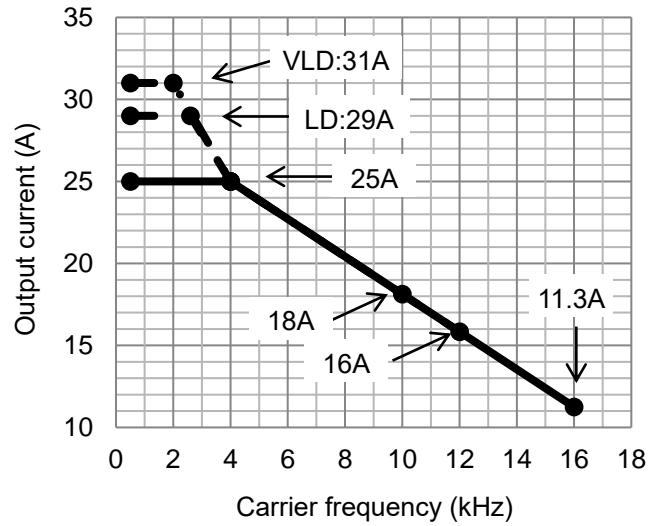

■P1-00250-H (P1-075H)

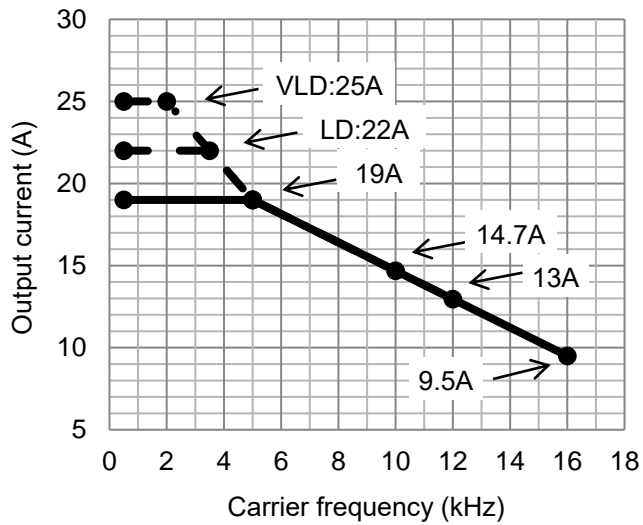

■P1-00400-H (P1-150H)

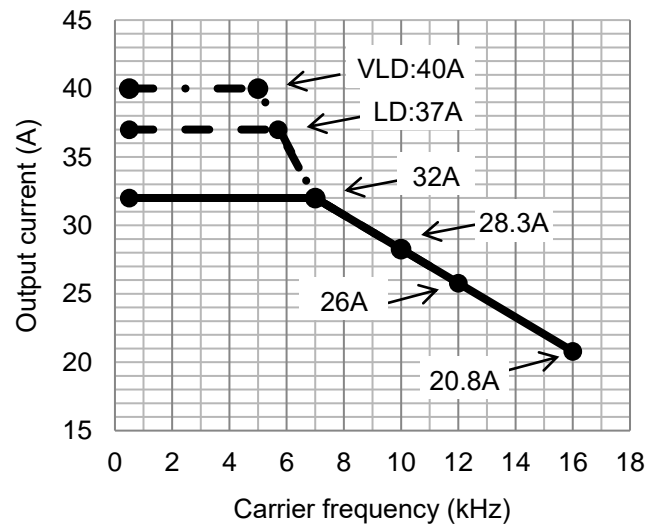

- 50°C: ND rating (normal duty rating)
- - -●- - - 45°C: LD rating (low duty rating)
- · · - - ● · · · 40°C: VLD rating (very low duty rating)

■ P1-00470-H (P1-185H)

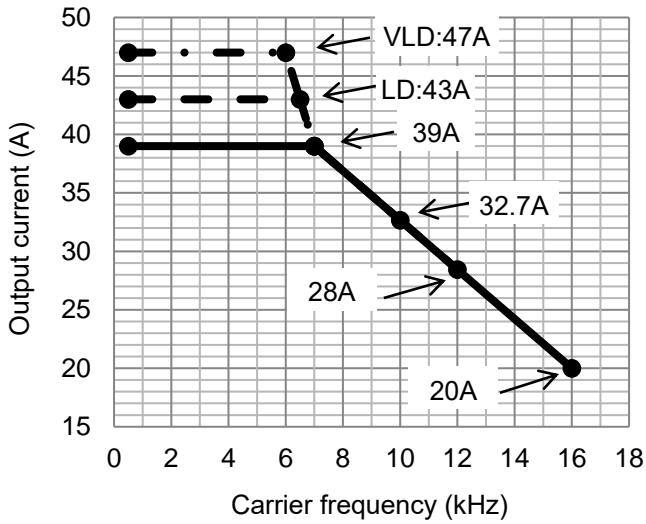

■ P1-00770-H (P1-300H)

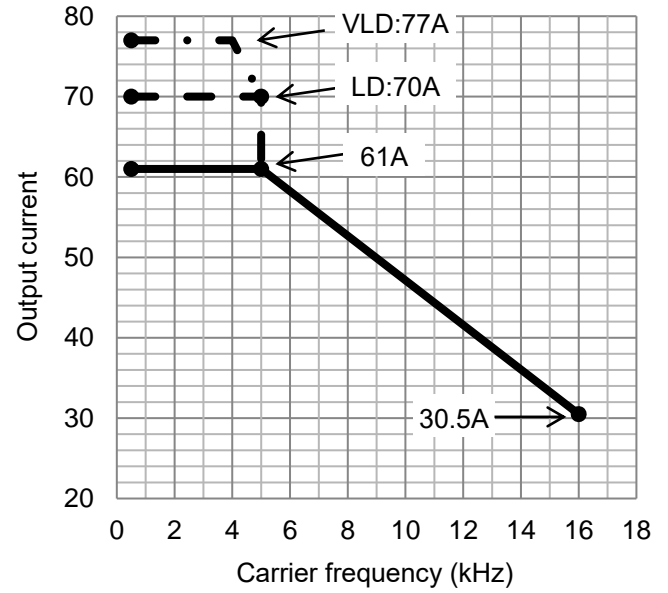

■ P1-00620-H (P1-220H)

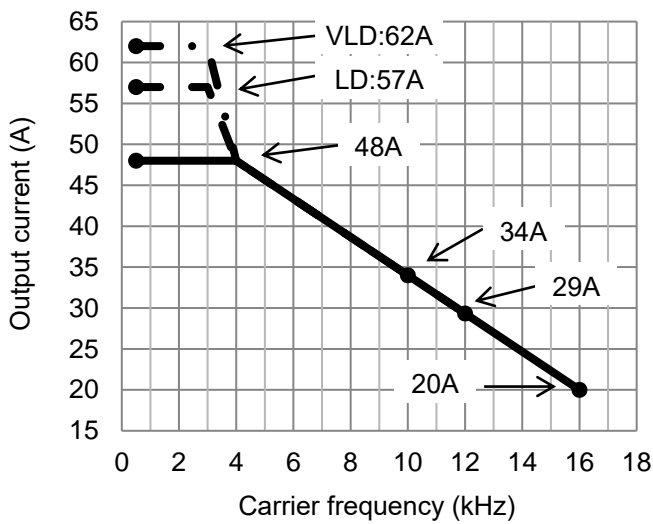

■ P1-00930-H (P1-370H)

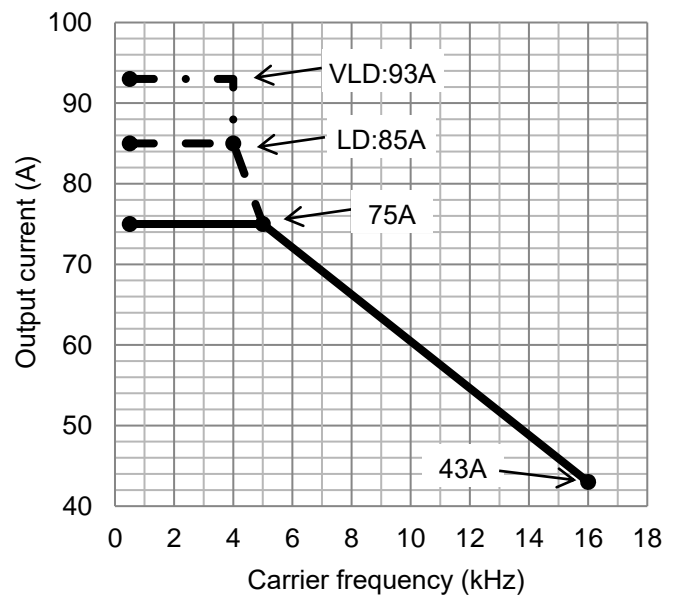

- 50°C: ND rating (normal duty rating)
- - -● 45°C: LD rating (low duty rating)
- 40°C: VLD rating (very low duty rating)

■ P1-01160-H (P1-450H)

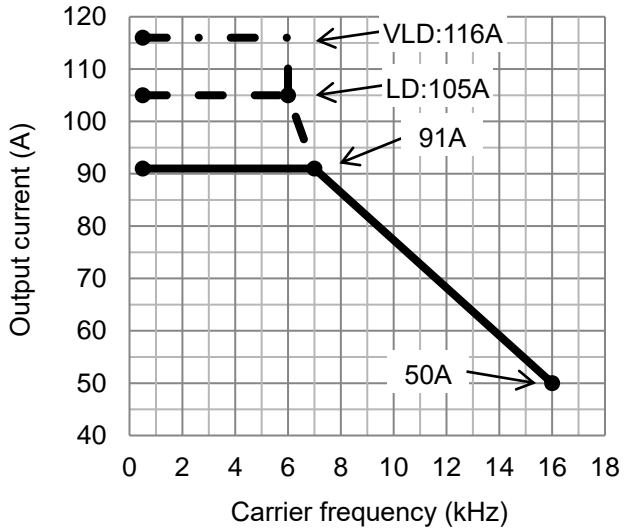

■ P1-01760-H (P1-750H)

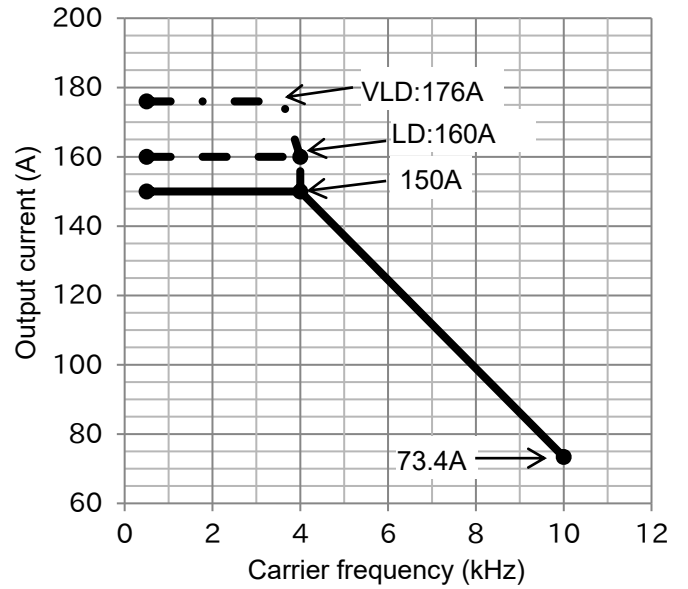

■ P1-01470-H (P1-550H)

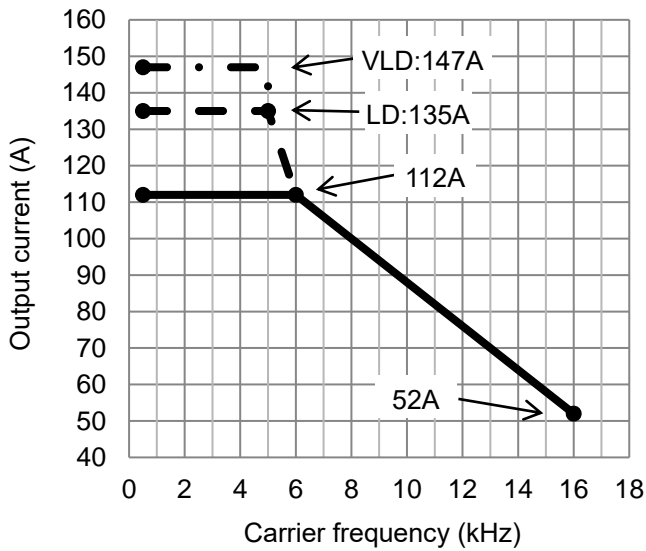

■ P1-02130-H (P1-900H)

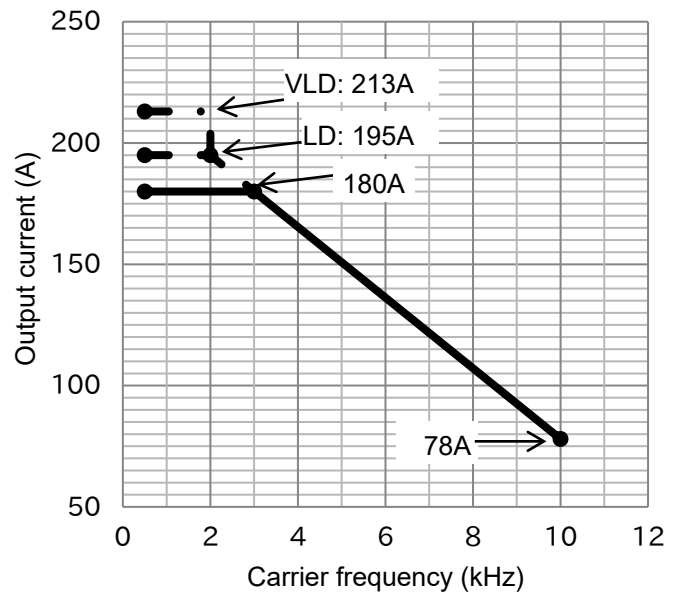

- 50°C: ND rating (normal duty rating)
- - -● 45°C: LD rating (low duty rating)
- · - ·● 40°C: VLD rating (very low duty rating)

■P1-02520-H (P1-1100H)

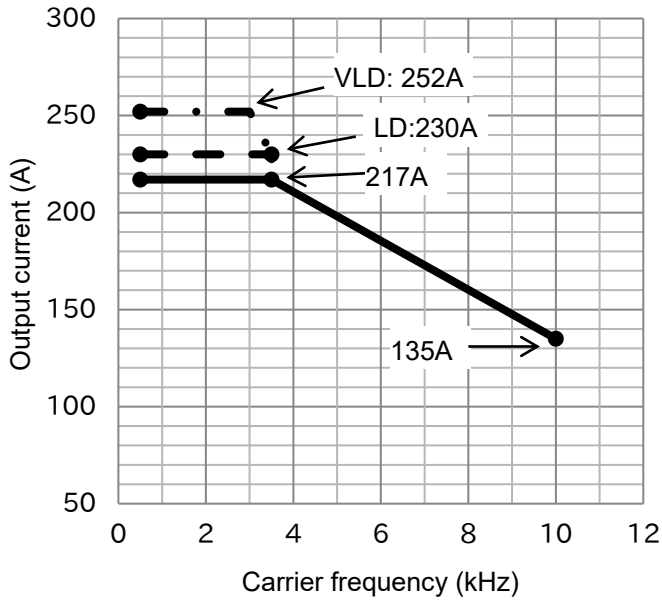

■P1-03720-H (P1-1600H)

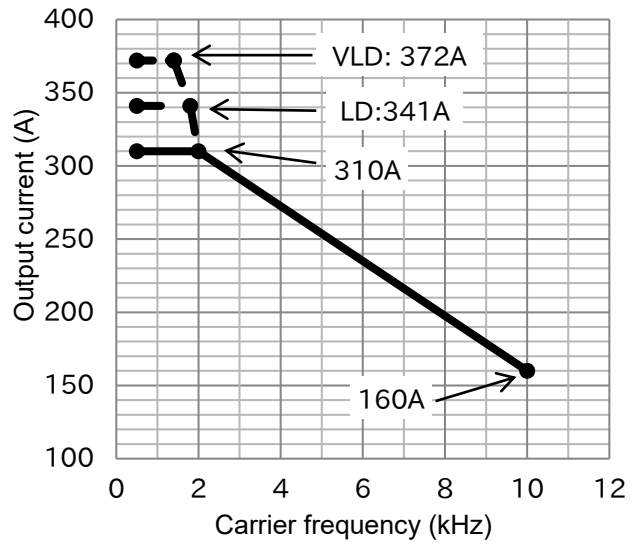

■P1-03160-H (P1-1320H)

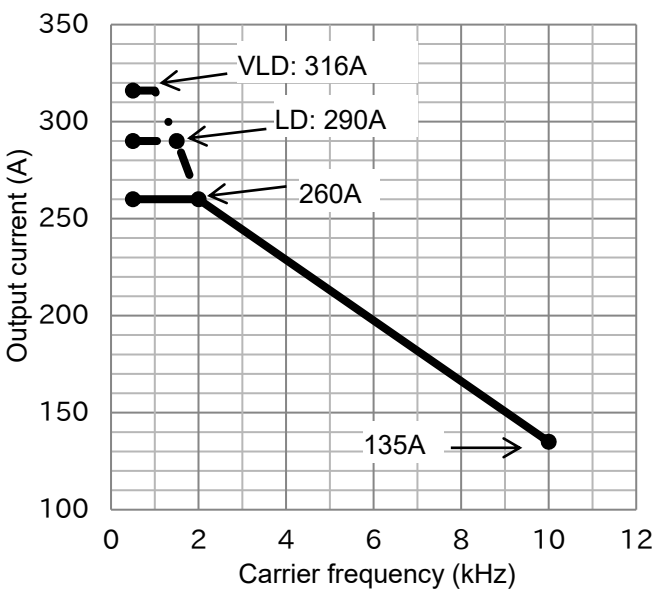

■P1-04320-H (P1-1850H)

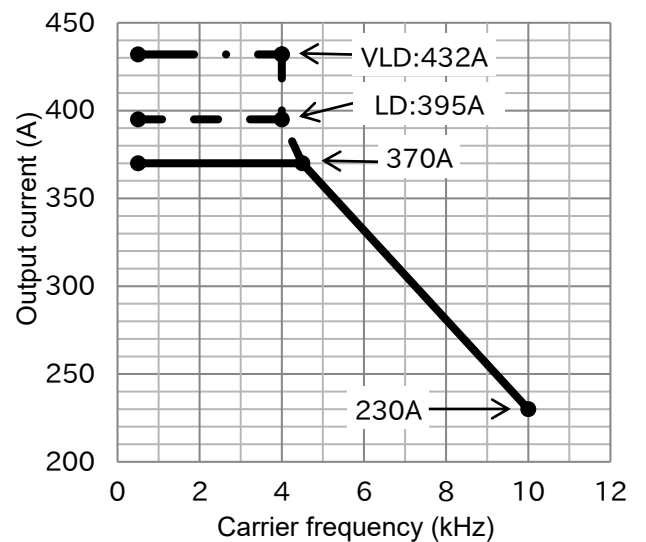

- 50°C: ND rating (normal duty rating)
- - -● 45°C: LD rating (low duty rating)
- · - ·● 40°C: VLD rating (very low duty rating)

■ P1-04860-H (P1-2000H)

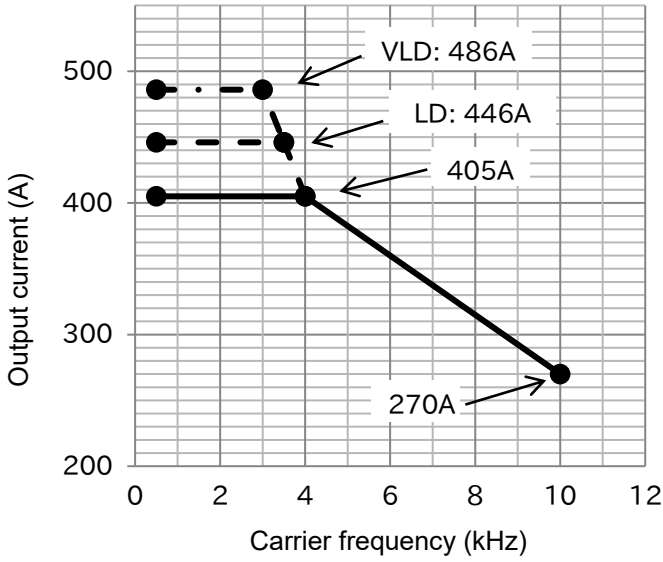

■ P1-05500-H (P1-2500H)

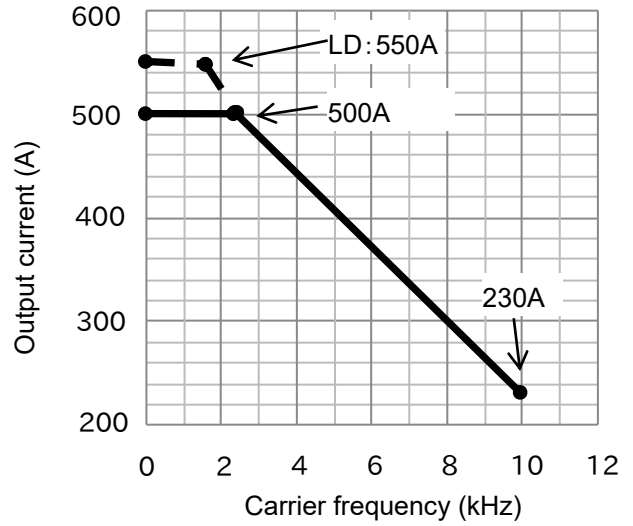

■ P1-05200-H (P1-2200H)

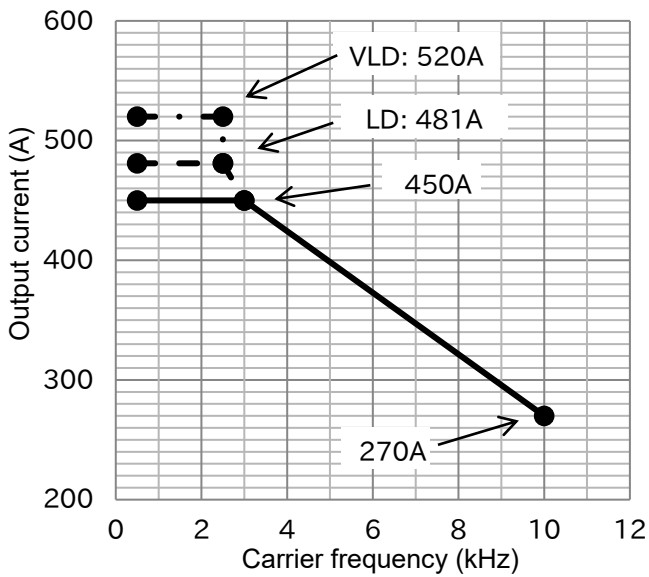

■ P1-06600-H (P1-3150H)

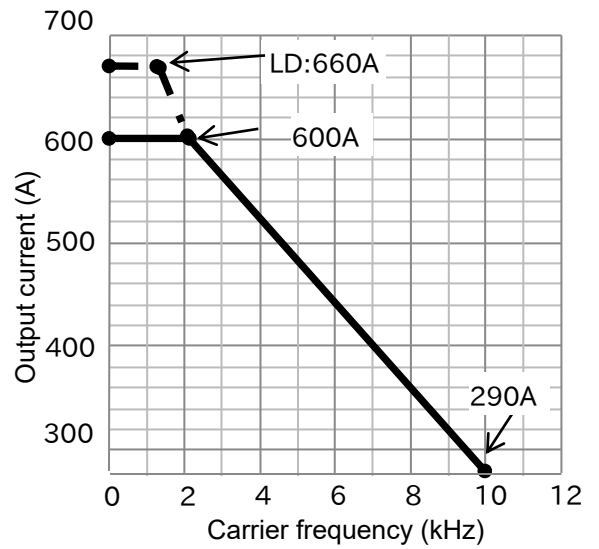





21

Chapter 21 Technical Notes

Contents

- 21.1 What This Chapter Explains 21-1
- 21.2 Replacement from SJ700-2/L700..... 21-2
 - 21.2.1 Comparison of External Dimensions..... 21-2
 - 21.2.2 Parameters..... 21-12
- 21.3 Summary of Changes in Each Version..... 21-28
 - 21.3.1 Changes in Ver. 2.00..... 21-28
 - 21.3.2 Changes in Ver. 2.01..... 21-30
 - 21.3.3 Changes in Ver. 2.02..... 21-31
 - 21.3.4 Changes in Ver. 2.03..... 21-35
- 21.4 STO Terminal Functions 21-37
 - 21.4.1 Safety Function, STO
(Safe Torque Off)..... 21-37
 - 21.4.2 Operation Procedure of
Safety Function 21-37
 - 21.4.3 Input Method of STO Signal..... 21-38
 - 21.4.4 STO Status Retention Function 21-39
 - 21.4.5 STO Confirmation Signal Output
(EDM Signal)..... 21-39
 - 21.4.6 Timing Diagram 21-40
 - 21.4.7 Status Indication Function..... 21-40

Symbol	Meanings
	General and troubleshooting questions
	Key points for a solution
	Notes
	Confirmation of operation procedures

21.1 What This Chapter Explains

This chapter describes the technical notes regarding the inverter.

It also shows the compatible models and compatible parameters when replacing SJ700 and L700 with P1. For detailed replacement procedures for each model, please contact your supplier or your local Hitachi inverter sales representative.

Configuration parameters can be converted using the setup software ProDriveNext.

21.2 Replacement from SJ700-2/L700

21.2.1 Comparison of External Dimensions

A

- Since SJ700 and P1 have the same installation pitch (excluding 315kW), installation is available without any change when replacing.
- When installing P1, see "Chapter 6 Installation".
- Basically, as shown in the table below, the replacement P1 model from the SJ700 series will be the same capacity P1 model with ND rating, and from the L700 series will be one lower capacity P1 model with LD rating.



Precautions for replacement

When selecting a model, check the P1 rated current, the rated current of the motor used, the ambient temperature, and the operation pattern. Also, check the carrier frequency setting and "20.4 Current Derating", and consider not to overload both the motor and the inverter's electronic thermal.

For details, refer to "12.7 Temperature Protection of Motor" and "12.19.9 Outputting a Warning Before Thermal Protection of the Inverter".

SJ700-2	⇒	Replacement from SJ700 : Load type = ND(Normal duty)
SJ700-004LFF2	⇒	P1-00044-LFF (P1-004LFF)
SJ700-007LFF2	⇒	P1-00080-LFF (P1-007LFF)
SJ700-015LFF2	⇒	P1-00104-LFF (P1-015LFF)
SJ700-022LFF2	⇒	P1-00156-LFF (P1-022LFF)
SJ700-037LFF2	⇒	P1-00228-LFF (P1-037LFF)
SJ700-007HFF2	⇒	P1-00041-HFF (P1-007HFF)
SJ700-015HFF2	⇒	P1-00054-HFF (P1-015HFF)
SJ700-022HFF2	⇒	P1-00083-HFF (P1-022HFF)
SJ700-037HFF2	⇒	P1-00126-HFF (P1-037HFF)

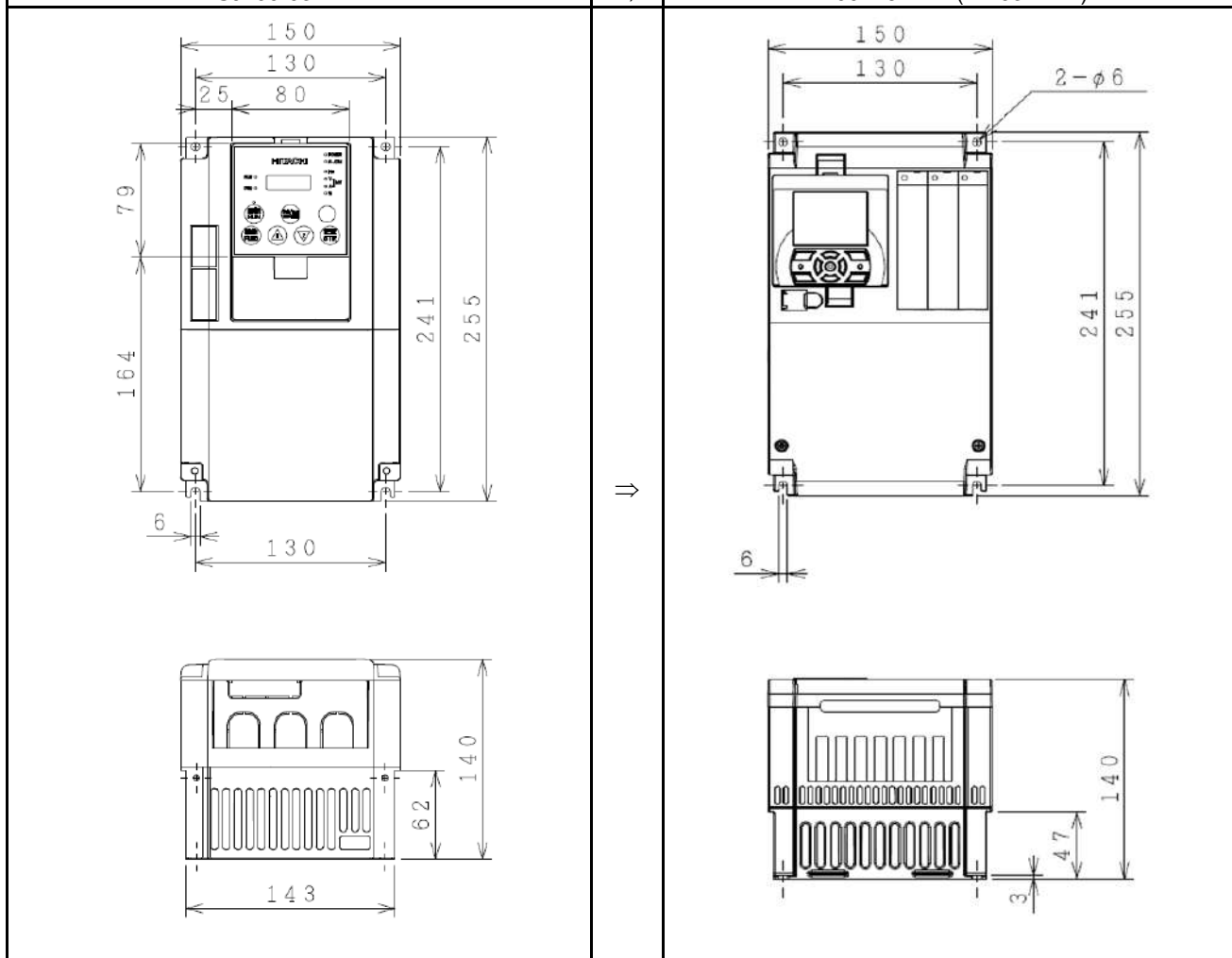

SJ700-2	L700	⇒	Replacement from SJ700 : Load type = ND(Normal duty) Replacement from L700 : Load type = LD(Low duty)
SJ700-055LFF2	-	⇒	P1-00330-LFF (P1-055LFF)
SJ700-075LFF2	L700-110LFF	⇒	P1-00460-LFF (P1-075LFF)
SJ700-110LFF2	L700-150LFF	⇒	P1-00600-LFF (P1-110LFF) *1)
SJ700-055HFF2	-	⇒	P1-00175-HFF (P1-055HFF)
SJ700-075HFF2	L700-110HFF	⇒	P1-00250-HFF (P1-075HFF)
SJ700-110HFF2	L700-150HFF	⇒	P1-00310-HFF (P1-110HFF)

⇒

*1) When using P1-00600-L (P1-110LFF) with LD rating, care must be taken regarding installation. For details, refer to “Notes for P1-00600-L (P1-110L)” in “6.3 External Dimensions”.

SJ700-2	L700	⇒	Replacement from SJ700 : Load type = ND(Normal duty) Replacement from L700 : Load type = LD(Low duty)
SJ700-150LFF2	L700-185LFF	⇒	P1-00800-LFF (P1-150LFF)
SJ700-185LFF2	L700-220LFF	⇒	P1-00930-LFF (P1-185LFF)
SJ700-220LFF2	L700-300LFF	⇒	P1-01240-LFF (P1-220LFF) *1)
SJ700-150HFF2	L700-185HFF	⇒	P1-00400-HFF (P1-150HFF)
SJ700-185HFF2	L700-220HFF	⇒	P1-00470-HFF (P1-185HFF)
SJ700-220HFF2	L700-300HFF	⇒	P1-00620-HFF (P1-220HFF)

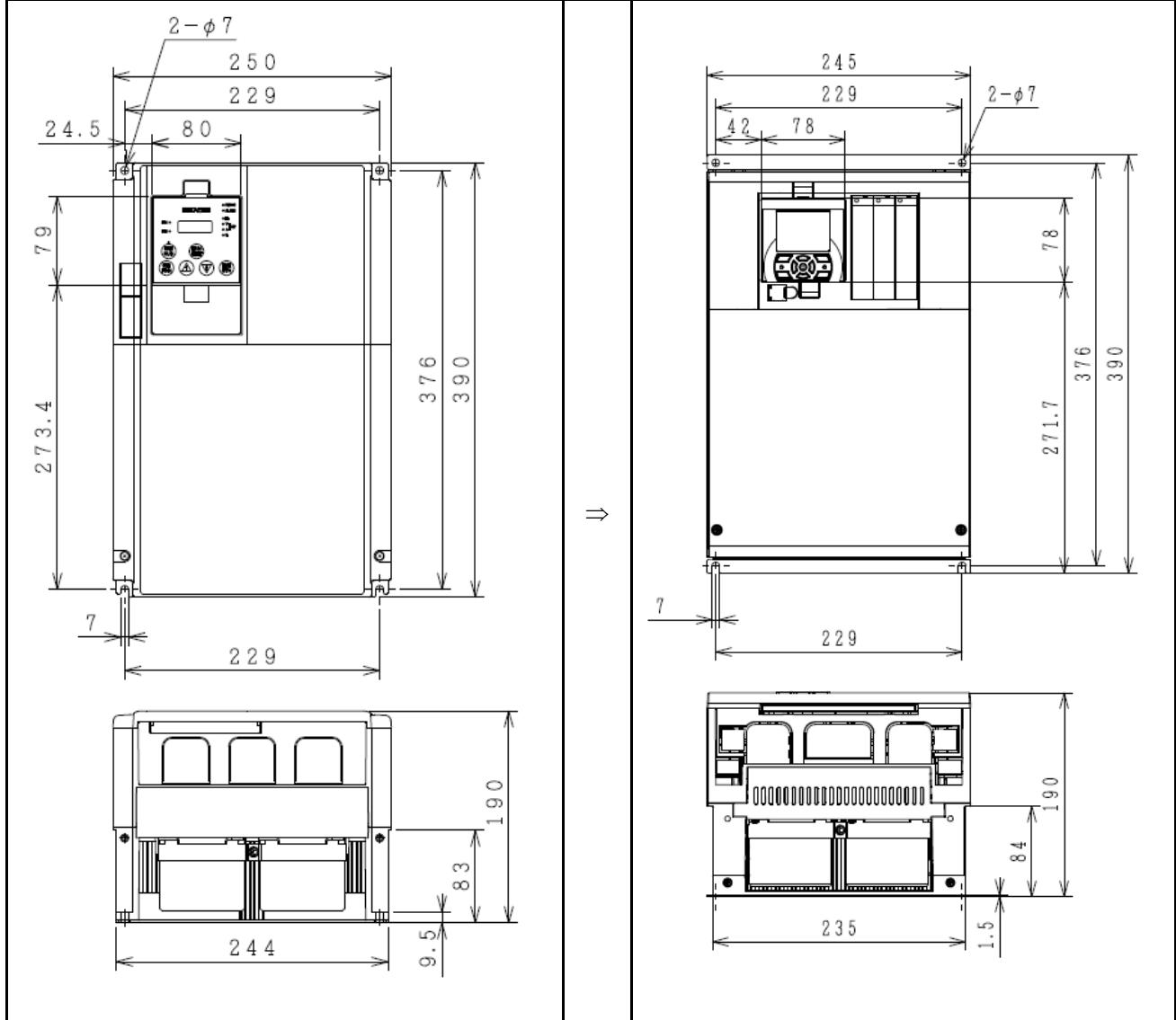

*1) When using P1-01240-L (P1-220LFF) with LD rating, care must be taken regarding installation. For details, refer to “Notes for P1-01240-L (P1-220L)” in “6.3 External Dimensions”.

SJ700-2	L700	⇒	Replacement from SJ700 : Load type = ND(Normal duty) Replacement from L700 : Load type = LD(Low duty)
SJ700-300LFF2	L700-370LFF	⇒	P1-01530-LFF(P1-300LFF)
SJ700-300HFF2	L700-370HFF	⇒	P1-00770-HFF(P1-300HFF)

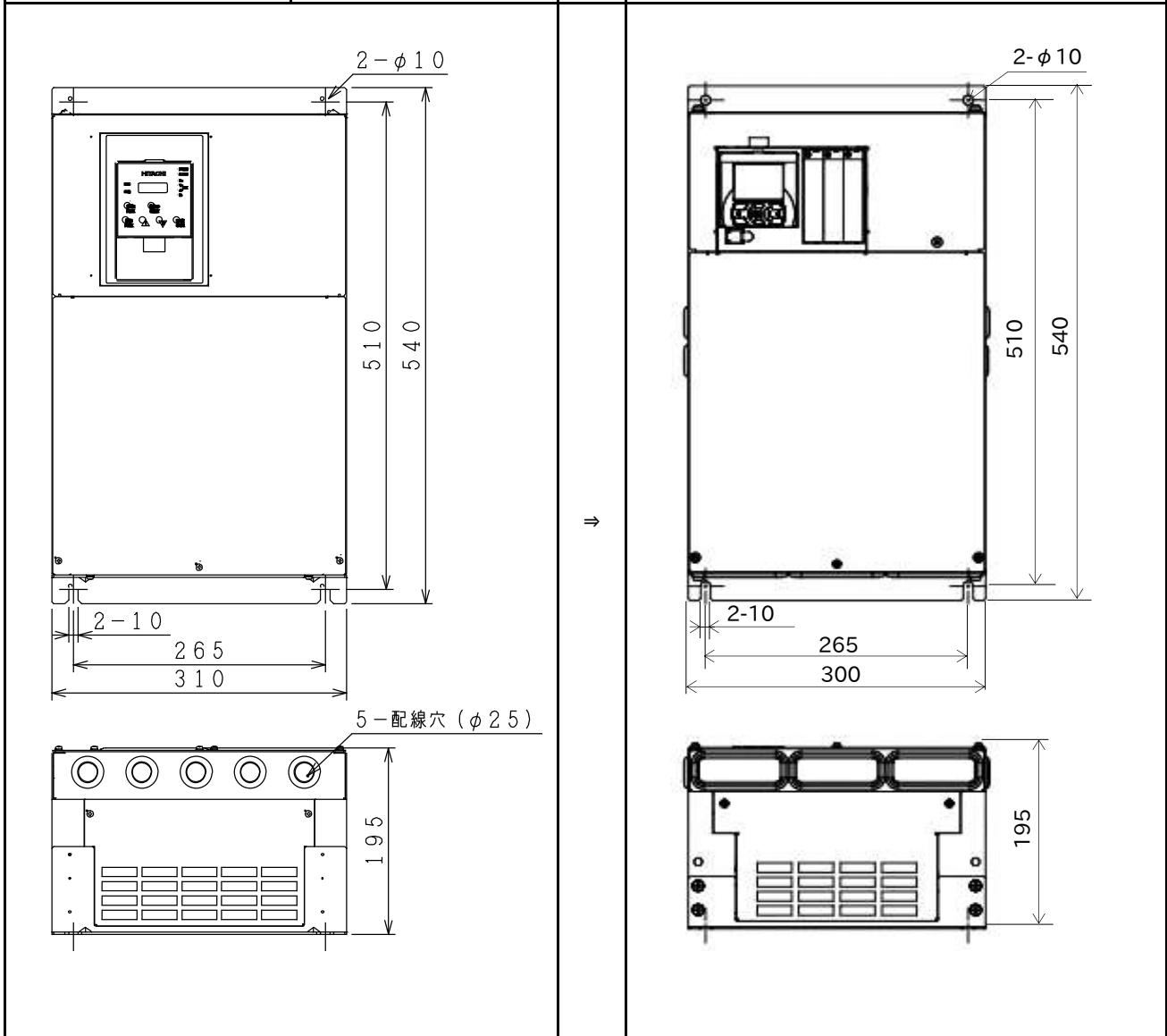

SJ700-2	L700	⇒	Replacement from SJ700 : Load type = ND(Normal duty) Replacement from L700 : Load type = LD(Low duty)
SJ700-370LFF2	L700-450LFF	⇒	P1-01850-LFF(P1-370LFF)
SJ700-450LFF2	L700-550LFF	⇒	P1-02290-LFF(P1-450LFF)
SJ700-370HFF2	L700-450HFF	⇒	P1-00930-HFF(P1-370HFF)
SJ700-450HFF2	L700-550HFF	⇒	P1-01160-HFF(P1-450HFF)
SJ700-550HFF2	L700-750HFF	⇒	P1-01470-HFF(P1-550HFF)

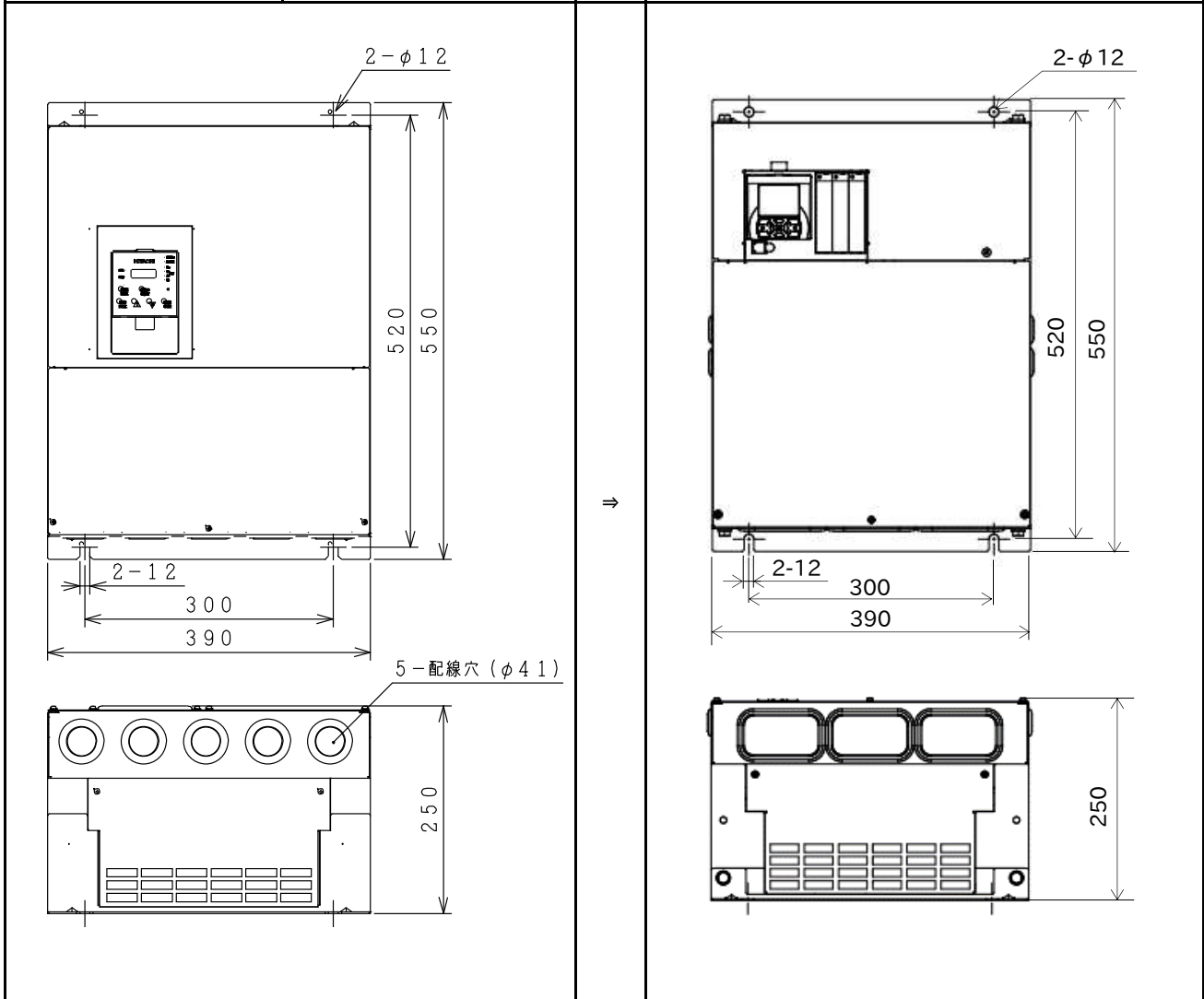

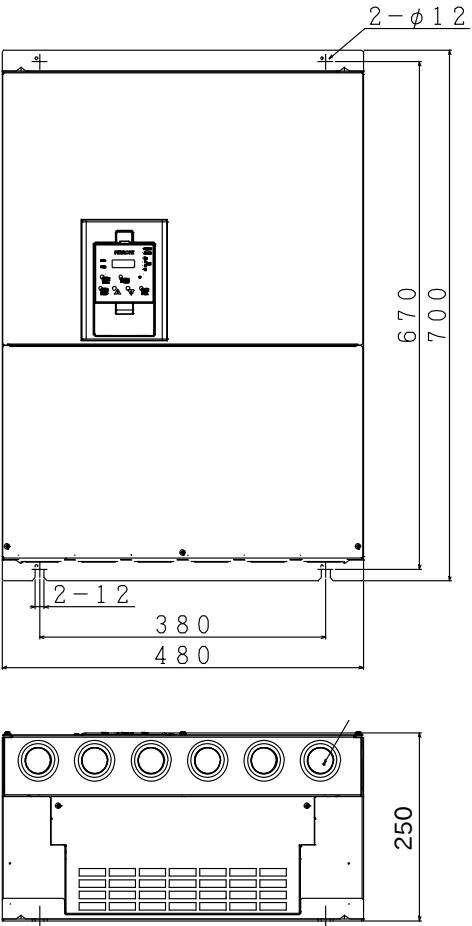
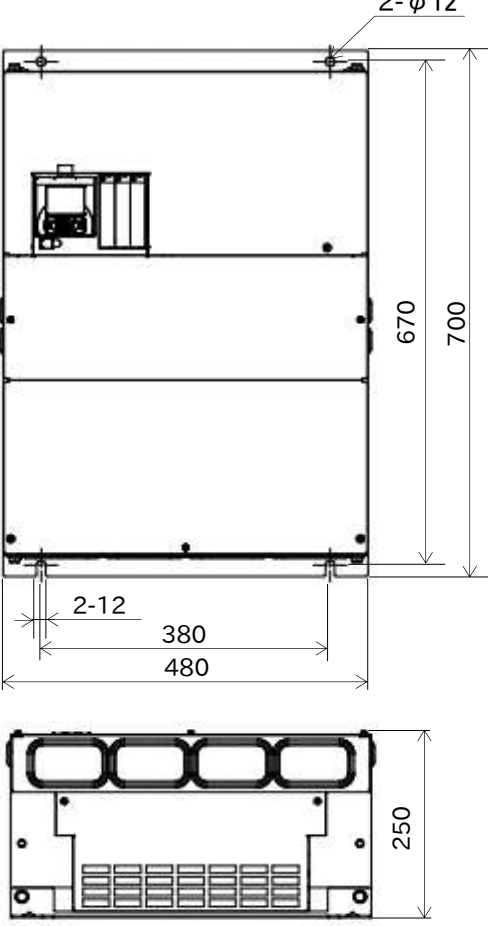
SJ700-2	L700	⇒	Replacement from SJ700 : Load type = ND(Normal duty) Replacement from L700 : Load type = LD(Low duty)
SJ700-550LFF2	L700-750LFF	⇒	P1-02950-LFF(P1-550LFF)
		⇓	

SJ700-2	L700	⇒	Replacement from SJ700 : Load type = ND(Normal duty) Replacement from L700 : Load type = LD(Low duty)
SJ700-750HFF2	L700-900HFF	⇒	P1-01760-HFF(P1-750HFF)
SJ700-900HFF2	L700-1100HFF	⇒	P1-02130-HFF(P1-900HFF)
<p>Technical drawing of the SJ700-2 unit. The front view shows a vertical rectangular unit with a total height of 700 mm and a mounting cutout height of 670 mm. Two mounting holes are located at the top, each with a diameter of 12 mm. The width is 390 mm, with a central cutout width of 300 mm and a 12 mm offset from the left edge. The bottom view shows a depth of 270 mm.</p>		⇒	<p>Technical drawing of the L700 unit. The front view shows a vertical rectangular unit with a total height of 700 mm and a mounting cutout height of 670 mm. Two mounting holes are located at the top, each with a diameter of 12 mm. The width is 390 mm, with a central cutout width of 300 mm and a 12 mm offset from the left edge. The bottom view shows a depth of 270 mm.</p>

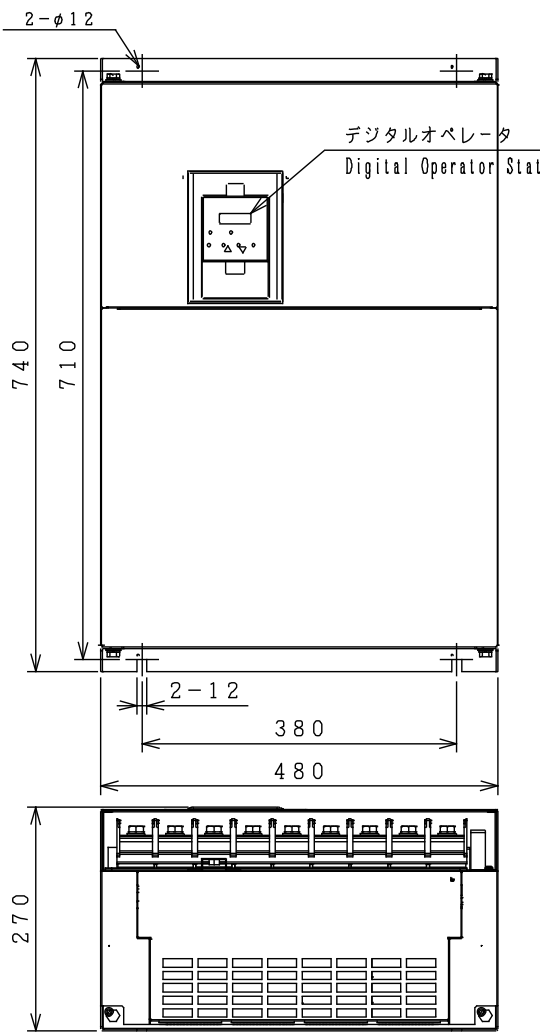
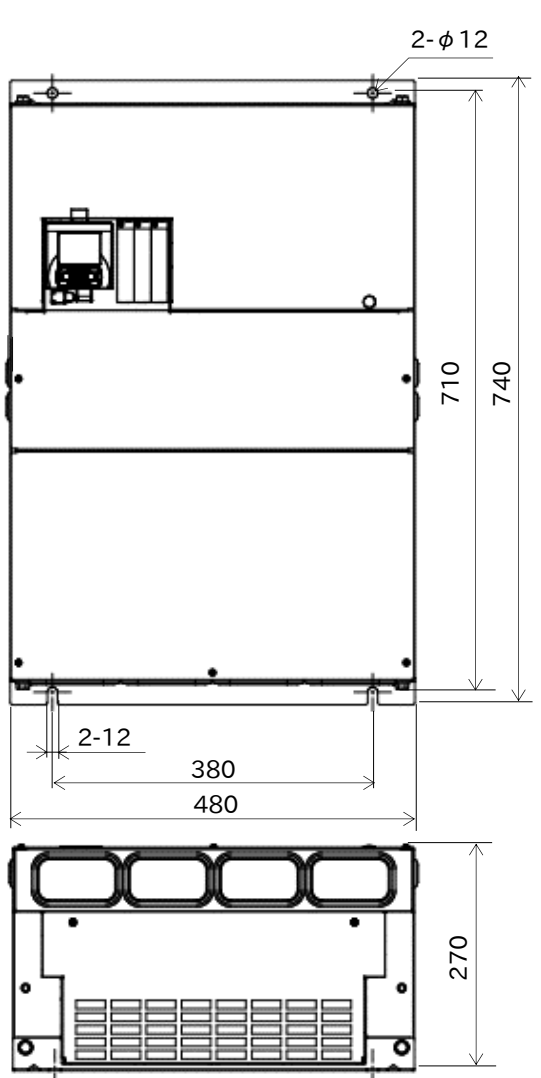
SJ700-2	L700	⇒	Replacement from SJ700 : Load type = ND(Normal duty) Replacement from L700 : Load type = LD(Low duty)
SJ700-1100HFF2	L700-1320HFF	⇒	P1-02520-HFF(P1-1100HFF)
SJ700-1320HFF2 SJ700-1500H**2	L700-1600HFF	⇒	P1-03160-HFF(P1-1320HFF)
 <p>Technical drawing of the SJ700-2 motor. It shows a front view and a top view. The front view has a total height of 740 mm and a mounting hole diameter of 2-φ12. The distance from the top edge to the center of the Digital Operator Station is 710 mm. The width is 480 mm, with a distance of 380 mm from the center to the side edge. The top view shows a height of 270 mm and a width of 480 mm. Labels include 'デジタルオペレータ' and 'Digital Operator Stat'.</p>		⇒	 <p>Technical drawing of the L700 motor. It shows a front view and a top view. The front view has a total height of 740 mm and a mounting hole diameter of 2-φ12. The distance from the top edge to the center of the Digital Operator Station is 710 mm. The width is 480 mm, with a distance of 380 mm from the center to the side edge. The top view shows a height of 270 mm and a width of 480 mm. Labels include '2-φ12', '2-12', '380', and '480'.</p>

SJ700-2	⇒	Replacement from SJ700 : Load type = ND(Normal duty)
SJ700-1850HFF2	⇒	P1-04320-HFF(P1-1850HFF)
SJ700-2200HFF2	⇒	P1-05200-HFF(P1-2200HFF)
<p>デジタルオペレータ Digital Operator Station</p> <p>965 995</p> <p>15 290 290 695</p> <p>370</p>	⇒	<p>680</p> <p>995 965</p> <p>290 15 290</p> <p>370 (2.3)</p>

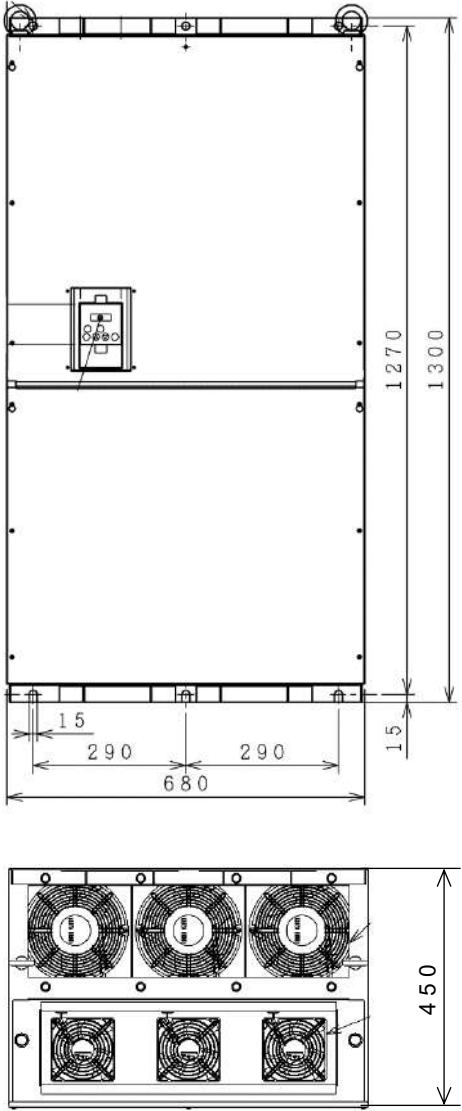
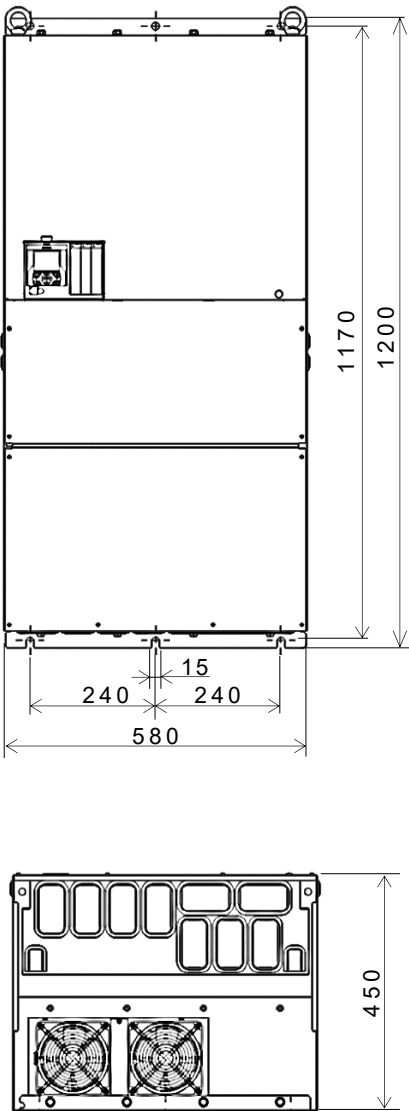
SJ700-2	⇒	Replacement from SJ700 : Load type = ND(Normal duty)
SJ700-3150HFF2	⇒	P1-06600-HFF(P1-3150HFF)
 <p>Technical drawing of the SJ700-3150HFF2 unit. The front view shows a rectangular unit with a total width of 680 mm and a total height of 1300 mm. The top section is 1270 mm high. The bottom section has a width of 680 mm, with two 290 mm segments and a 15 mm gap. The rear view shows a height of 450 mm with three fans in the top row and three fans in the bottom row.</p>	<p>⇒</p>	 <p>Technical drawing of the P1-06600-HFF(P1-3150HFF) unit. The front view shows a rectangular unit with a total width of 580 mm and a total height of 1200 mm. The top section is 1170 mm high. The bottom section has a width of 580 mm, with two 240 mm segments and a 15 mm gap. The rear view shows a height of 450 mm with two fans in the bottom row.</p>

21.2.2 Parameters

* The content of parameters may be different depending on SJ700 and P1. Set parameters after fully checking description of the functions.

SJ700-2/L700		P1	Remarks
Display code	Function name	New code	
d001	Output frequency monitor	dA-01	
d002	Output current monitor	dA-02	
d003	Operation direction monitor	dA-03	
d004	PID feedback monitor	db-30	
d005	Intelligent input monitor	dA-51	
d006	Intelligent output monitor	dA-54	
d007	Frequency conversion monitor	dA-06	
d008	Real frequency monitor	dA-08	
d009	Torque command monitor	FA-15	These torque related functions are valid when the Control mode selection [AA121] / [AA221] is set to 08(IM-SLV), 09(IM-0Hz-SLV), or 10(IM-CLV). [FA-15] is valid at 08 or 10.
d010	Torque bias monitor	FA-16	
d012	Output torque monitor	dA-17	
d013	Output voltage monitor	dA-18	
d014	Input power monitor	dA-30	
d015	Integrated power monitor	dA-32	
d016	Cumulative operating hours monitor during RUN	dC-22	
d017	Power ON time monitor	dC-24	
d018	Cooling fin temperature monitor	dC-15	
d019	Motor temperature monitor	dA-38	
d022	Life diagnostic monitor	dC-16	
d023	Program counter	db-03	
d024	Program number monitor	db-02	
d025	User monitor 0	db-08	
d026	User monitor 1	db-10	
d027	User monitor 2	db-12	
d028	Pulse counter monitor	dA-28	
d029	Position command monitor	FA-20	
d030	Current position monitor	dA-20	
d060	Inverter mode monitor	dC-01 dC-45	[dC-01] confirms the duty type, and [dC-45] confirms the IM / SM selection.
d080	Trip frequency monitor	-	Displayed on the trip history screen of the keypad VOP.
d081	Trip history monitor 1	-	Displayed on the trip history screen of the keypad VOP.
d082	Trip history monitor 2	-	Displayed on the trip history screen of the keypad VOP.
d083	Trip history monitor 3	-	Displayed on the trip history screen of the keypad VOP.
d084	Trip history monitor 4	-	Displayed on the trip history screen of the keypad VOP.
d085	Trip history monitor 5	-	Displayed on the trip history screen of the keypad VOP.
d086	Trip history monitor 6	-	Displayed on the trip history screen of the keypad VOP.
d090	Warning monitor	-	Displayed on the warning screen of the keypad VOP.
d102	DC voltage monitor	dA-40	
d103	BRD load factor monitor	dA-41	
d104	BRD thermal load factor monitor	dA-42	

SJ700-2/L700		P1	Remarks
Display code	Function name	New code	
F001	Output frequency setting	FA-01	
F002	First acceleration time setting	AC120	
F202	Second acceleration time setting	AC220	
F302	Third acceleration time setting	-	Abolition of 3rd motor control
F003	First deceleration time setting	AC122	
F203	Second deceleration time setting	AC222	
F303	Third deceleration time setting	-	Abolition of 3rd motor control
F004	Operation direction selection	AA-12	
A001	Frequency command selection	AA101	Added 2nd-motor control:[AA201]
A002	Operation command selection	AA111	
A003	First base frequency	Hb104/Hd104	[Hb104] : IM, [Hd104] : SM(PMM)
A203	Second base frequency	Hb204/Hd204	[Hb204] : IM, [Hd204] : SM(PMM)
A303	Third base frequency	-	Abolition of 3rd motor control
A004	First maximum frequency	Hb105/Hd105	[Hb105] : IM, [Hd105] : SM(PMM)
A204	Second maximum frequency	Hb205/Hd205	[Hb205] : IM, [Hd205] : SM(PMM)
A304	Third maximum frequency	-	Abolition of 3rd motor control
A005	AT terminal selection	-	Similar function is possible by switching the analog current / voltage input by DIPSW on the board and switching the main speed [AA101] / sub speed [AA102] by input terminal function [SCHG].
A006	O2 selection	-	This function is substituted by the setting of [Cb-22]
A011	0 start	Cb-03	For Ai1
A012	0 end	Cb-04	For Ai1
A013	0 start ratio	Cb-05	For Ai1
A014	0 end ratio	Cb-06	For Ai1
A015	0 start selection	Cb-07	For Ai1
A016	Analog input filter	Cb-01	For Ai1 ([Cb-11] for Ai2 , [Cb-21] for Ai3)
A017	Simplified sequence function selection	UE-02	
A019	Multistep speed selection	Ab-03	
A020	0th speed of the 1st multi-step speed	Ab110	
A220	0th speed of the 2nd multi-step speed	Ab210	
A320	0th speed of the 3rd multi-step speed	-	Abolition of 3rd motor control
A021	1st speed of the multi-step speed	Ab-11	
A022	2nd speed of the multi-step speed	Ab-12	
A023	3rd speed of the multi-step speed	Ab-13	
A024	4th speed of the multi-step speed	Ab-14	
A025	5th speed of the multi-step speed	Ab-15	
A026	6th speed of the multi-step speed	Ab-16	
A027	7th speed of the multi-step speed	Ab-17	
A028	8th speed of the multi-step speed	Ab-18	
A029	9th speed of the multi-step speed	Ab-19	
A030	10th speed of the multi-step speed	Ab-20	
A031	11th speed of the multi-step speed	Ab-21	
A032	12th speed of the multi-step speed	Ab-22	
A033	13th speed of the multi-step speed	Ab-23	
A034	14th speed of the multi-step speed	Ab-24	
A035	15th speed of the multi-step speed	Ab-25	

SJ700-2/L700		P1	Remarks
Display code	Function name	New code	
A038	Jogging frequency	AG-20	
A039	Jogging selection	AG-21	
A041	First torque boost selection	AA121	When [A041] is set to 01, select 03: automatic boost for [AA121].
A241	Second torque boost selection	AA221	When [A241] is set to 01, select 03: automatic boost for [AA221].
A042	First manual torque boost volume	Hb141	* Re-confirmation is required for setting.
A242	Second manual torque boost volume	Hb241	* Re-confirmation is required for setting.
A342	Third manual torque boost volume	-	Abolition of 3rd motor control
A043	First manual torque boost break point	Hb142	* Re-confirmation is required for setting.
A243	Second manual torque boost break point	Hb242	* Re-confirmation is required for setting.
A343	Third manual torque boost break point	-	Abolition of 3rd motor control
A044	First control mode	AA121	* Re-confirmation is required for setting.
A244	Second control mode	AA221	* Re-confirmation is required for setting.
A344	Third control mode	-	Abolition of 3rd motor control
A045	Output voltage gain	Hb180	Added 2nd-motor control:[Hb280]
A046	First voltage compensation gain for automatic torque boost	HC101	
A246	Second voltage compensation gain for automatic torque boost	HC201	
A047	First slip compensation gain for automatic torque boost	HC102	
A247	Second slip compensation gain for automatic torque boost	HC202	
A051	DC braking selection	AF101	Added 2nd-motor control:[AF201]
A052	DC braking frequency	AF103	Added 2nd-motor control:[AF203]
A053	DC braking delay time	AF104	Added 2nd-motor control:[AF204]
A054	DC braking force	AF105	Added 2nd-motor control:[AF205]
A055	DC braking time	AF106	Added 2nd-motor control:[AF206]
A056	DC braking edge/level selection	AF107	Added 2nd-motor control:[AF207]
A057	DC braking force at the start	AF108	Added 2nd-motor control:[AF208]
A058	DC braking time at the start	AF109	Added 2nd-motor control:[AF209]
A059	DC braking carrier frequency	-	Integrated into [bb101]
A061	First frequency upper limiter	bA102	
A261	Second frequency upper limiter	bA202	
A062	First frequency lower limiter	bA103	
A262	Second frequency lower limiter	bA203	
A063	Jump frequency 1	AG101	Added 2nd-motor control:[AG201]
A064	Jump frequency width 1	AG102	Added 2nd-motor control:[AG202]
A065	Jump frequency 2	AG103	Added 2nd-motor control:[AG203]
A066	Jump frequency width 2	AG104	Added 2nd-motor control:[AG204]
A067	Jump frequency 3	AG105	Added 2nd-motor control:[AG205]
A068	Jump frequency width 3	AG106	Added 2nd-motor control:[AG206]
A069	Acceleration stop frequency	AG110	Added 2nd-motor control:[AG210]
A070	Acceleration stop time	AG111	Added 2nd-motor control:[AG211]

SJ700-2/L700		P1	Remarks
Display code	Function name	New code	
A071	PID selection	AH-01	
A072	PID P gain	AH-61	
A073	PID I gain	AH-62	
A074	PID D gain	AH-63	
A075	PID scale	-	Configured with [AH-04] to [AH-06]
A076	PID feedback selection	AH-51	
A077	PID deviation reverse output	AH-02	
A078	PID changeable range	AH-71	
A079	PID feed forward selection	AH-70	
A081	AVR selection	bA146	Added 2nd-motor control:[bA246] Note: Valid only during V/f control mode.
A082	Motor incoming voltage selection	Hb106/Hd106	Configured with [Hb106](IM)/[Hd106](SM/PMM)
A085	Operation mode selection	Hb145	Added 2nd-motor control:[Hb245]
A086	Energy-saving response/accuracy adjustment	Hb146	Added 2nd-motor control:[Hb246]
A092	First acceleration time 2	AC124	
A292	Second acceleration time 2	AC224	
A392	Second acceleration time 3	-	Abolition of 3rd motor control
A093	First deceleration time 2	AC126	
A293	Second deceleration time 2	AC226	
A393	Second deceleration time 3	-	Abolition of 3rd motor control
A094	First 2-step acceleration/deceleration selection	AC115	
A294	Second 2-step acceleration/deceleration selection	AC215	
A095	First 2-stage acceleration frequency	AC116	
A295	Second 2-stage acceleration frequency	AC216	
A096	First 2-stage deceleration frequency	AC117	
A296	Second 2-stage deceleration frequency	AC217	
A097	Acceleration pattern selection	AC-03	
A098	Deceleration pattern selection	AC-04	

SJ700-2/L700		P1	Remarks
Display code	Function name	New code	
A101	OI start	Cb-13	For Ai2
A102	OI end	Cb-14	For Ai2
A103	OI start ratio	Cb-15	For Ai2
A104	OI end ratio	Cb-16	For Ai2
A105	OI start selection	Cb-17	For Ai2
A111	O2 start	Cb-23	For Ai3
A112	O2 end	Cb-24	For Ai3
A113	O2 start ratio	Cb-25	For Ai3
A114	O2 end ratio	Cb-26	For Ai3
A131	Acceleration curve constant	AC-05	
A132	Deceleration curve constant	AC-06	
A141	Operation frequency selection 1	AA101	Integrated into main speed/sub speed command. Added 2nd-motor control:[AA201]
A142	Arithmetic operation frequency selection 2	AA102	Integrated into main speed/sub speed command. Added 2nd-motor control:[AA202]
A143	Arithmetic operation operator selection	AA105	Added 2nd-motor control:[AA205]
A145	Additional frequency setting	AA106	Added 2nd-motor control:[AA206]
A146	Additional frequency sign selection	-	There is no corresponding parameter because a negative number can be set in [AA106].
A150	Curvature 1 for EL-S-shaped acceleration	AC-08	
A151	Curvature 2 for EL-S-shaped acceleration	AC-09	
A152	Curvature 1 for EL-S-shaped deceleration	AC-10	
A153	Curvature 2 for EL-S-shaped deceleration	AC-11	

SJ700-2/L700		P1	Remarks
Display code	Function name	New code	
b001	Selection of instantaneous power failure/undervoltage restart	bb-24	To make it the same as [b001]=00(trip), set [bb-20](instantaneous power failure) / [bb-21] (under voltage) to 0.
b002	Allowable instantaneous power failure time	bb-25	
b003	Retry stand-by time for instantaneous power failure and insufficient voltage	bb-26	
b004	Instantaneous power failure/undervoltage tripping selection during stop	bb-27	
b005	Selection of instantaneous power failure retry count	bb-20	0: trip, 255: infinite
b006	Input phase loss selection	bb-65	
b007	f matching lower limit frequency setting	bb-42	
b008	Trip retry selection	bb-28	To make it the same as [b008]=00(trip), set [bb-22](overcurrent) / [bb-23] (over voltage) to 0.
b009	Selection of undervoltage retry count	bb-21	0: trip, 255: infinite
b010	Selection of overvoltage/overcurrent retry count	bb-22 bb-23	Specify [bb-22] overcurrent / [bb-23] overvoltageand individually.
b011	Trip retry standby time	bb-29	
b012	First electronic thermal level	bC110	
b212	Second electronic thermal level	bC210	
b312	Third electronic thermal level	-	Abolition of 3rd motor control
b013	Selection of first electronic thermal characteristics	bC111	
b213	Selection of second electronic thermal characteristics	bC211	
b313	Selection of third electronic thermal characteristics	-	Abolition of 3rd motor control
b015	Free electronic thermal frequency 1	bC120	Added 2nd-motor control:[bC220]
b016	Free electronic thermal current 1	bC121	Added 2nd-motor control:[bC221]
b017	Free electronic thermal frequency 2	bC122	Added 2nd-motor control:[bC222]
b018	Free electronic thermal current 2	bC123	Added 2nd-motor control:[bC223]
b019	Free electronic thermal frequency 3	bC124	Added 2nd-motor control:[bC224]
b020	Free electronic thermal current 3	bC125	Added 2nd-motor control:[bC225]
b021	Overload limit selection	bA122	Added 2nd-motor control:[bA222]
b022	Overload limit level	bA123	Added 2nd-motor control:[bA223]
b023	Overload limit constant	bA124	Added 2nd-motor control:[bA224]
b024	Overload limit selection 2	bA126	Added 2nd-motor control:[bA226]
b025	Overload limit level 2	bA127	Added 2nd-motor control:[bA227]
b026	Overload limit constant 2	bA128	Added 2nd-motor control:[bA228]
b027	Overcurrent suppression selection	bA120	Added 2nd-motor control:[bA220]
b028	Frequency pull-in restart level	bb-43	
b029	Frequency pull-in restart constant	bb-44	
b030	Start frequency selection for frequency pull-in restart	bb-47	
b031	Soft-lock selection	UA-16	
b034	RUN time/power supply ON time level	CE-36	
b035	Operation direction limit selection	AA114	Added 2nd-motor control:[AA214]
b036	Reduced voltage start selection	Hb131	Added 2nd-motor control:[Hb231]
b037	Display selection	UA-10	
b038	Initial screen selection	UA-91	The initial screen can be selected in the System setting of the operator keypad VOP.
b039	User parameter automatic setting function	UA-30	

SJ700-2/L700		P1	Remarks
Display code	Function name	New code	
b040	Torque limit selection	bA110	Added 2nd-motor control:[bA210]
b041	Torque limit 1 (Four-quadrant mode normal powered)	bA112	Added 2nd-motor control:[bA212]
b042	Torque limit 2 (Four-quadrant mode reverse regenerative)	bA113	Added 2nd-motor control:[bA213]
b043	Torque limit 3 (Four-quadrant mode reverse powered)	bA114	Added 2nd-motor control:[bA214]
b044	Torque limit 4 (Four-quadrant mode normal regenerative)	bA115	Added 2nd-motor control:[bA215]
b045	Torque LADSTOP selection	bA116	Added 2nd-motor control:[bA216]
b046	Selection of reversal prevention	HC114	Added 2nd-motor control:[HC214]
b050	Instantaneous power failure non-stop selection	bA-30	
b051	Instantaneous power failure non-stop starting voltage	bA-31	
b052	Instantaneous power failure non-stop OV-LADSTOP level (target voltage level)	bA-32	
b053	Instantaneous power failure non-stop deceleration time	bA-34	
b054	Instantaneous power failure non-stop deceleration start range	bA-36	
b055	Instantaneous power failure non-stop proportional gain setting	bA-37	
b056	Instantaneous power failure non-stop integrated time setting	bA-38	
b060	Window comparator O upper limit	CE-40	
b061	Window comparator O lower limit	CE-41	
b062	Window comparator O hysteresis width	CE-42	
b063	Window comparator OI upper limit level	CE-43	
b064	Window comparator OI lower limit level	CE-44	
b065	Window comparator OI hysteresis width	CE-45	
b066	Window comparator O2 upper limit level	CE-46	
b067	Window comparator O2 lower limit level	CE-47	
b068	Window comparator O2 hysteresis width	CE-48	
b070	O operation level at disconnection	CE-50	
b071	OI operation level at disconnection	CE-52	
b072	O2 operation level at disconnection	CE-54	
b078	Deletion of integrated power	UA-12	
b079	Integrated power display gain	UA-13	
b082	Starting frequency	Hb130	Added 2nd-motor control:[Hb230]
b083	Carrier frequency	bb101	Added 2nd-motor control:[bb201]
b084	Selection of initialization	Ub-01	
b085	Initialization data selection	Ub-02	
b086	Frequency conversion coefficient	Ab-01	
b087	Stop key selection	AA-13	
b088	Free-run stop selection	bb-40	
b089	Automatic carrier reduction	bb103	Added 2nd-motor control:[bb203]
b090	BRD use rate	bA-60	
b091	Stop mode selection	AA115	Added 2nd-motor control:[AA215]
b092	Cooling fan operation selection	bA-70	
b095	BRD selection	bA-61	
b096	BRD on level	bA-62	
b098	Thermistor selection	Cb-40	
b099	Thermistor error level	bb-70	

SJ700-2/L700		P1	Remarks
Display code	Function name	New code	
b100	Free V/f frequency 1	Hb150	Added 2nd-motor control:[Hb250]
b101	Free V/f voltage 1	Hb151	Added 2nd-motor control:[Hb251]
b102	Free V/f frequency 2	Hb152	Added 2nd-motor control:[Hb252]
b103	Free V/f voltage 2	Hb153	Added 2nd-motor control:[Hb253]
b104	Free V/f frequency 3	Hb154	Added 2nd-motor control:[Hb254]
b105	Free V/f voltage 3	Hb155	Added 2nd-motor control:[Hb255]
b106	Free V/f frequency 4	Hb156	Added 2nd-motor control:[Hb256]
b107	Free V/f voltage 4	Hb157	Added 2nd-motor control:[Hb257]
b108	Free V/f frequency 5	Hb158	Added 2nd-motor control:[Hb258]
b109	Free V/f voltage 5	Hb159	Added 2nd-motor control:[Hb259]
b110	Free V/f frequency 6	Hb160	Added 2nd-motor control:[Hb260]
b111	Free V/f voltage 6	Hb161	Added 2nd-motor control:[Hb261]
b112	Free V/f frequency 7	Hb162	Added 2nd-motor control:[Hb262]
b113	Free V/f voltage 7	Hb163	Added 2nd-motor control:[Hb263]
b120	Brake control selection	AF130	Added 2nd-motor control:[AF230]
b121	Establishment waiting time	AF131	Added 2nd-motor control:[AF231]
b122	Acceleration waiting time	AF132	Added 2nd-motor control:[AF232]
b123	Stop waiting time	AF133	Added 2nd-motor control:[AF233]
b124	Brake check waiting time	AF134	Added 2nd-motor control:[AF234]
b125	Brake release frequency	AF135	Added 2nd-motor control:[AF235]
b126	Brake release current	AF136	Added 2nd-motor control:[AF236]
b127	Brake apply frequency	AF137	Added 2nd-motor control:[AF237]
b130	Overvoltage suppression function selection	bA140	Added 2nd-motor control:[bA240]
b131	Overvoltage suppression level	bA141	Added 2nd-motor control:[bA241]
b132	Overvoltage suppression constant	bA142	Added 2nd-motor control:[bA243]
b133	Overvoltage suppression proportional gain setting	bA144	Added 2nd-motor control:[bA244]
b134	Overvoltage suppression integrated time setting	bA145	Added 2nd-motor control:[bA245]

SJ700-2/L700		P1	Remarks
Display code	Function name	New code	
C001	Selection of intelligent input terminal 1	CA-01	
C002	Selection of intelligent input terminal 2	CA-02	
C003	Selection of intelligent input terminal 3	CA-03	
C004	Selection of intelligent input terminal 4	CA-04	
C005	Selection of intelligent input terminal 5	CA-05	
C006	Selection of intelligent input terminal 6	CA-06	
C007	Selection of intelligent input terminal 7	CA-07	
C008	Selection of intelligent input terminal 8	CA-08	
C011	Selection of intelligent input terminal 1a/b (NO/NC)	CA-21	
C012	Selection of intelligent input terminal 2a/b (NO/NC)	CA-22	
C013	Selection of intelligent input terminal 3a/b (NO/NC)	CA-23	
C014	Selection of intelligent input terminal 4a/b (NO/NC)	CA-24	
C015	Selection of intelligent input terminal 5a/b (NO/NC)	CA-25	
C016	Selection of intelligent input terminal 6a/b (NO/NC)	CA-26	
C017	Selection of intelligent input terminal 7a/b (NO/NC)	CA-27	
C018	Selection of intelligent input terminal 8a/b (NO/NC)	CA-28	
C019	Selection of FW terminal a/b (NO/NC)	CA-29	When [CA-09] is set to "FW"
C021	Selection of intelligent output terminal 11	CC-01	
C022	Selection of intelligent output terminal 12	CC-02	
C023	Selection of intelligent output terminal 13	CC-03	
C024	Selection of intelligent output terminal 14	CC-04	
C025	Selection of intelligent output terminal 15	CC-05	
C026	Selection of intelligent relay terminal	CC-07	
C027	FM selection	Cd-03	
C028	AM selection	Cd-04	
C029	AMI selection	Cd-05	
C030	Reference value of digital current monitor	-	Configured with [Cd-02] (settings need to be checked)
C031	Selection of intelligent output terminal 11a/b (NO/NC)	CC-11	
C032	Selection of intelligent output terminal 12a/b (NO/NC)	CC-12	
C033	Selection of intelligent output terminal 13a/b (NO/NC)	CC-13	
C034	Selection of intelligent output terminal 14a/b (NO/NC)	CC-14	
C035	Selection of intelligent output terminal 15a/b (NO/NC)	CC-15	
C036	Selection of intelligent relay a/b (NO/NC)	CC-17	
C038	Low current signal output mode selection	CE101	Added 2nd-motor control:[CE201]
C039	Low current detection level	CE102	Added 2nd-motor control:[CE202]
C040	Overload advance notice signal output mode selection	CE105	Added 2nd-motor control:[CE205]
C041	Overload advance notice level	CE106	Added 2nd-motor control:[CE206]
C042	Acceleration reaching frequency	CE-10	
C043	Deceleration reaching frequency	CE-11	
C044	PID excessive deviation level	AH-72	
C045	Acceleration reaching frequency 2	CE-12	
C046	Deceleration reaching frequency 2	CE-13	

SJ700-2/L700		P1	Remarks
Display code	Function name	New code	
C052	Feedback comparison signal OFF level	AH-73	
C053	Feedback comparison signal ON level	AH-74	
C055	Overtorque level (normal rotation powered)	CE120	Added 2nd-motor control:[CE220]
C056	Overtorque level (reverse rotation regenerative)	CE121	Added 2nd-motor control:[CE221]
C057	Overtorque level (reverse rotation powered)	CE122	Added 2nd-motor control:[CE222]
C058	Overtorque level (normal rotation regenerative)	CE123	Added 2nd-motor control:[CE223]
C061	Thermal warning level	CE-30	
C062	Alarm code selection	-	This function is enabled by assigning "Alarm code bits 0 to 3" to the output terminal functions [CC-01] to [CC-07].
C063	0Hz detection level	CE-33	
C064	Cooling fin overheat advance notice level	CE-34	
C071	Communication transmission speed selection	CF-01	
C072	Communication station number selection	CF-02	
C073	Communication bit length selection	-	Abolished because only Modbus-RTU is supported.
C074	Communication parity selection	CF-03	
C075	Communication stop bit selection	CF-04	
C076	Communication error selection	CF-05	
C077	Communication trip time	CF-06	
C078	Stop waiting time	CF-07	
C079	Communication method selection	-	Abolished because only Modbus-RTU is supported.
C081	O adjustment	Cb-30/Cb-31	Similar function is adjustment with [Cb-30] and [Cb-31], but not exact same.
C082	OI adjustment	Cb-32/Cb-33	Similar function is adjustment with [Cb-32] and [Cb-33], but not exact same.
C083	O2 adjustment	Cb-34/Cb-35	Similar function is adjustment with [Cb-34] and [Cb-35], but not exact same.
C085	Thermistor adjustment	Cb-41	
C091	Debug mode selection	UC-01	
C101	UP/DWN memory selection	CA-61	
C102	Reset selection	CA-72	
C103	Reset f matching selection	bb-41	
C105	FM gain setting	Cd-14	
C106	AM gain setting	Cd-24	
C107	AMI gain setting	Cd-34	
C109	AM bias setting	Cd-23	
C110	AMI bias setting	Cd-33	
C111	Overload advance notice level 2	CE107	
C121	O zero adjustment	Cb-30/Cb-31	Similar function is adjustment with [Cb-30] and [Cb-31], but not exact same.
C122	OI zero adjustment	Cb-32/Cb-33	Similar function is adjustment with [Cb-32] and [Cb-33], but not exact same.
C123	O2 zero adjustment	Cb-34/Cb-35	Similar function is adjustment with [Cb-34] and [Cb-35], but not exact same.

SJ700-2/L700		P1	Remarks
Display code	Function name	New code	
C130	Output 11 on-delay time	CC-20	
C131	Output 11 off-delay time	CC-21	
C132	Output 12 on-delay time	CC-22	
C133	Output 12 off-delay time	CC-23	
C134	Output 13 on-delay time	CC-24	
C135	Output 13 off-delay time	CC-25	
C136	Output 14 on-delay time	CC-26	
C137	Output 14 off-delay time	CC-27	
C138	Output 15 on-delay time	CC-28	
C139	Output 15 off-delay time	CC-29	
C140	Output RY on-delay time	CC-32	
C141	Output RY off-delay time	CC-33	
C142	Logical output signal 1 selection 1	CC-40	
C143	Logical output signal 1 selection 2	CC-41	
C144	Logical output signal 1 operator selection	CC-42	
C145	Logical output signal 2 selection 1	CC-43	
C146	Logical output signal 2 selection 2	CC-44	
C147	Logical output signal 2 operator selection	CC-45	
C148	Logical output signal 3 selection 1	CC-46	
C149	Logical output signal 3 selection 2	CC-47	
C150	Logical output signal 3 operator selection	CC-48	
C151	Logical output signal 4 selection 1	CC-49	
C152	Logical output signal 4 selection 2	CC-50	
C153	Logical output signal 4 operator selection	CC-51	
C154	Logical output signal 5 selection 1	CC-52	
C155	Logical output signal 5 selection 2	CC-53	
C156	Logical output signal 5 operator selection	CC-54	
C157	Logical output signal 6 selection 1	CC-55	
C158	Logical output signal 6 selection 2	CC-56	
C159	Logical output signal 6 operator selection	CC-57	
C160	Input terminal response time 1	CA-41	
C161	Input terminal response time 2	CA-42	
C162	Input terminal response time 3	CA-43	
C163	Input terminal response time 4	CA-44	
C164	Input terminal response time 5	CA-45	
C165	Input terminal response time 6	CA-46	
C166	Input terminal response time 7	CA-47	
C167	Input terminal response time 8	CA-48	
C168	Input terminal response time FW	CA-49	
C169	Multistage speed/position determination time	CA-55	

SJ700-2/L700		P1	Remarks
Display code	Function name	New code	
H001	Auto-tuning selection	HA-01	
H002	First motor constant selection	-	There is only one motor constant table. The initial value is Hitachi's IE3 motor.
H202	Second motor constant selection	-	
H003	First motor capacity selection	Hb102	
H203	Second motor capacity selection	Hb202	
H004	First selection of the number of motor poles	Hb103	
H204	Second selection of the number of motor poles	Hb203	
H005	First speed response	HA115	* Adjustment may be required.
H205	Second speed response	HA215	* Adjustment may be required.
H006	First stability constant	HA110	* Adjustment may be required.
H206	Second stability constant	HA210	* Adjustment may be required.
H306	Third stability constant	-	Abolition of 3rd motor control
H020	First motor R1	Hb110	* Adjustment may be required.
H220	Second motor R1	Hb210	* Adjustment may be required.
H021	First motor R2	Hb112	* Adjustment may be required.
H221	Second motor R2	Hb212	* Adjustment may be required.
H022	First motor L	Hb114	* Adjustment may be required.
H222	Second motor L	Hb214	* Adjustment may be required.
H023	First motor I0	Hb116	* Adjustment may be required.
H223	Second motor I0	Hb216	* Adjustment may be required.
H024	First motor J	Hb118	* Adjustment may be required.
H224	Second motor J	Hb218	* Adjustment may be required.
H030	First motor R1 (auto-tuning data)	-	[Hb110]: Integration of setting location
H230	Second motor R1 (auto-tuning data)	-	[Hb210]: Integration of setting location
H031	First motor R2 (auto-tuning data)	-	[Hb112]: Integration of setting location
H231	Second motor R2 (auto-tuning data)	-	[Hb212]: Integration of setting location
H032	First motor L (auto-tuning data)	-	[Hb114]: Integration of setting location
H232	Second motor L (auto-tuning data)	-	[Hb214]: Integration of setting location
H033	First motor I0 (auto-tuning data)	-	[Hb116]: Integration of setting location
H233	Second motor I0 (auto-tuning data)	-	[Hb216]: Integration of setting location
H034	First motor J (auto-tuning data)	-	[Hb118]: Integration of setting location
H234	Second motor J (auto-tuning data)	-	[Hb218]: Integration of setting location

SJ700-2/L700		P1	Remarks
Display code	Function name	New code	
H050	First PI proportional gain	HA125	* Adjustment may be required.
H250	Second PI proportional gain	HA225	* Adjustment may be required.
H051	First PI proportional gain	HA126	* Adjustment may be required.
H251	Second PI integrated gain	HA226	* Adjustment may be required.
H052	First P proportional gain	HA127	* Adjustment may be required.
H252	Second P proportional gain	HA227	* Adjustment may be required.
H060	First 0Hz range limiter	HC110	
H260	Second 0Hz range limiter	HC210	
H061	First 0Hz range SLV start boost volume	HC112	
H261	Second 0Hz range SLV start boost volume	HC212	
H070	For switching PI proportional gain	HA128	* Adjustment may be required.
H071	For switching PI integrated gain	HA129	* Adjustment may be required.
H072	For switching P proportional gain	HA130	* Adjustment may be required.
H073	Gain switch time	HA121	

SJ700-2/L700		P1	Remarks
Display code	Function name	New code	
P001	Selection of operation at option 1 error	oA-12	
P002	Selection of operation at option 2 error	oA-22	
P011	Number of pulses of encoder	ob-01	
P012	V2 control mode selection	AA123	
P013	Pulse string mode selection	ob-11	
P014	Orientation stop position	AE-11	
P015	Orientation speed setting	AE-12	
P016	Orientation direction setting	AE-13	
P017	Positioning completion range setting	AE-04	
P018	Positioning completion delay time setting	AE-05	
P019	Electronic gear installation position selection	AE-01	
P020	Numerator of electronic gear ratio	AE-02	
P021	Denominator of electronic gear ratio	AE-03	
P022	Positioning control feed forward gain	AE-06	
P023	Position loop gain	AE-07	
P024	Position bias volume	AE-08	
P025	Selection of whether a secondary-resistance correction is to be conducted.	HC113	Added 2nd-motor control:[HC213]
P026	Overspeed error detection level	bb-80	
P027	Overspeed deviation error detection level	bb-83	
P028	Numerator of motor gear ratio	ob-03	
P029	Denominator of motor gear ratio	ob-04	
P031	Acceleration or deceleration time input type	AC-01	
P032	Orientation stop position input type	AE-10	
P033	Torque command input selection	Ad-01	
P034	Torque command setting	Ad-02	
P035	Selection of pole at torque command by O2	Ad-03	Not limited to Ai3.
P036	Torque bias mode	Ad-11	
P037	Torque bias value	Ad-12	
P038	Torque bias polarity selection	Ad-13	
P039	Torque control speed limit value (for normal rotation)	Ad-41	
P040	Torque control speed limit value (for reverse rotation)	Ad-42	
P044	Timer setting for monitoring of DeviceNet operation command	oA-11 or oA-21 or oA-31	Note: If P1-DN is installed in slot 1, P044 = oA-11, P045 = oA-12.
P045	Operation setting at the time of communication error	oA-12 or oA-22 or oA-32	
P046	OUTPUT assembly instance No. setting	oH-41	
P047	INPUT assembly instance No. setting	oH-41	
P048	Operation setting at the time of detection of idle mode	oH-45	Note: For P1, parameter setting is possible only from the host device.

SJ700-2/L700		P1	Remarks
Display code	Function name	New code	
P049	Setting of the number of poles for rotation speed	-	Integrated to Hb103 (IM)/Hd103 (SM/PMM)
P055	Pulse string frequency scale	ob-12	
P056	Pulse string frequency time constant	ob-13	
P057	Position string bias volume	ob-14	
P058	Pulse string limit	ob-15	
P060	Position command 0	AE-20	
P061	Position command 1	AE-22	
P062	Position command 2	AE-24	
P063	Position command 3	AE-26	
P064	Position command 4	AE-28	
P065	Position command 5	AE-30	
P066	Position command 6	AE-32	
P067	Position command 7	AE-34	
P068	Zero return mode	AE-70	
P069	Zero return direction selection	AE-71	
P070	Low speed zero return frequency	AE-72	
P071	High speed zero return frequency	AE-73	
P072	Position range designation (forward rotation side)	AE-52	
P073	Position range designation (reverse rotation side)	AE-54	
P074	Teaching selection	AE-60	

SJ700-2/L700		P1	Remarks
Display code	Function name	New code	
P100	Simplified sequence function user parameter U (00)	UE-10	
P101	Simplified sequence function user parameter U (01)	UE-11	
P102	Simplified sequence function user parameter U (02)	UE-12	
P103	Simplified sequence function user parameter U (03)	UE-13	
P104	Simplified sequence function user parameter U (04)	UE-14	
P105	Simplified sequence function user parameter U (05)	UE-15	
P106	Simplified sequence function user parameter U (06)	UE-16	
P107	Simplified sequence function user parameter U (07)	UE-17	
P108	Simplified sequence function user parameter U (08)	UE-18	
P109	Simplified sequence function user parameter U (09)	UE-19	
P110	Simplified sequence function user parameter U (10)	UE-20	
P111	Simplified sequence function user parameter U (11)	UE-21	
P112	Simplified sequence function user parameter U (12)	UE-22	
P113	Simplified sequence function user parameter U (13)	UE-23	
P114	Simplified sequence function user parameter U (14)	UE-24	
P115	Simplified sequence function user parameter U (15)	UE-25	
P116	Simplified sequence function user parameter U (16)	UE-26	
P117	Simplified sequence function user parameter U (17)	UE-27	
P118	Simplified sequence function user parameter U (18)	UE-28	
P119	Simplified sequence function user parameter U (19)	UE-29	
P120	Simplified sequence function user parameter U (20)	UE-30	
P121	Simplified sequence function user parameter U (21)	UE-31	
P122	Simplified sequence function user parameter U (22)	UE-32	
P123	Simplified sequence function user parameter U (23)	UE-33	
P124	Simplified sequence function user parameter U (24)	UE-34	
P125	Simplified sequence function user parameter U (25)	UE-35	
P126	Simplified sequence function user parameter U (26)	UE-36	
P127	Simplified sequence function user parameter U (27)	UE-37	
P128	Simplified sequence function user parameter U (28)	UE-38	
P129	Simplified sequence function user parameter U (29)	UE-39	
P130	Simplified sequence function user parameter U (30)	UE-40	
P131	Simplified sequence function user parameter U (31)	UE-41	
U001	User 1 selection	UA-31	
U002	User 2 selection	UA-32	
U003	User 3 selection	UA-33	
U004	User 4 selection	UA-34	
U005	User 5 selection	UA-35	
U006	User 6 selection	UA-36	
U007	User 7 selection	UA-37	
U008	User 8 selection	UA-38	
U009	User 9 selection	UA-39	
U010	User 10 selection	UA-40	
U011	User 11 selection	UA-41	
U012	User 12 selection	UA-42	

21.3 Summary of Changes in Each Version

A

- There are some changes in the specifications and functions depending on each version.
- Please check the version of your product and check the following additions and changes.
- Please refer to “4.3.2 Specification Label ” for the product version. The product version can be confirmed with the parameter [dC-50].

21.3.1 Changes in Ver. 2.00

Ver.1.00	Description	Ver.2.00	Description	Page
–	Addition of function	IM: V/f control with encoder Free V/f control with encoder Automatic boost control with encoder	With speed feedback from the motor to the feedback option P1-FB or the input terminals A/B, various controls are performed with speed correction.	12-9-1, 12-9-16 to 12-9-23
–	Addition of function	IM: Vector control with encoder Speed control/torque control Position control function	With speed feedback from the motor to the feedback option P1-FB or the input terminals A/B, Vector control requiring high torque is performed. Position control is also possible through feedback.	12-9-1 12-9-24 12-11-1 12-17-17
–	Addition of function	SM (PMM): IVMS-start type sensorless vector control	The Hitachi's unique method to control permanent magnet motor at high torque from the start	12-9-26
–	Addition of function	Forced display function	The function to fix the screen.	12-5-6
–	Addition of function	Display selection function Password function	Selects the content of display. Includes a comparison function that only displays changed parameters and user parameter function that only displays set data. You can fix the conditions of display limitation using a password.	9-25
–	Addition of function	User parameter automatic setting	Changed parameters are automatically saved.	9-33
–	Addition of function	Forced operation function	Operation is forcibly performed by terminal input.	12-17-13
–	Addition of function	Bypass mode function	When the inverter cannot run during forced operation, this function can be used on a system driven by commercial power supply.	12-17-15
–	Addition of function	Automatic reset function	When a trip occurs, trip is canceled after a specified time. A trip due to major failure error cannot be canceled.	12-24-19
–	Addition of function	Data trace function	Using the occurrence of errors as a trigger, data at the time of trigger is saved. The data can be checked using a PC tool "ProDriveNext".	16-7
–	Addition of function	Soft-lock function Password function	When using the soft-lock function to protect parameters, you can set a password to prevent others from changing the parameters.	9-34
–	Addition of function	Optional cassette function	The optional cassettes for P1 can be used.	15-1
–	Addition of function	Abnormal speed deviation/excessive speed deviation	This function warns speed deviation. It can be used for control with sensor.	12-16-11

Ver.1.00	Description	Ver.2.00	Description	Page
–	Addition of function	Battery level warning function	This function warns battery level on the operator keypad.	9-41
–	Addition of function	Retry history function	You can display retry history on VOP.	9-17
PID1 function PID2 function	Function extension	PID1 function (addition of target and feedback) PID2 function PID3 function PID4 function PID start abnormal judgment	The PID function was extended. <ul style="list-style-type: none"> · The target and feedback of PID1 are covered in total of 3 systems. · Added PID3 and PID4 · Abnormal judgment upon startup 	12-10-1
Brake control function	Function extension	Addition of brake control function 2	A brake function using vector-controlled servo lock was added.	12-17-8
–	Addition of function	Contacting control	A function was added, enabling control of a contactor arranged on the secondary side of the inverter.	12-17-10
Upper limit	Function extension	Upper limit selection	The function was extended so that a value other than the parameter value can be set for the upper limit.	12-6-1
Compare-match function	Addition of function	Compare-match function (phase factor mode)	In addition to the low interval detection mode, input pulse in pulse string input is counted, and an output signal is output if compare-match is performed.	12-24-16

21.3.2 Changes in Ver. 2.01

The following explanation is the contents implemented by the update in the Ver. 2.01.

[1] Added functions

The following functions were added to the Ver.2.01.

NO.	Function	Ver.2.01	Ver.2.00 or lower
1	Operation panel VOP display language	Can be selected from one of these 7 languages ・English, ・Japanese (日本語), ・French (Français), ・Spanish (Español), ・Turkish (Türkçe), ・Polish (język polski), ・Czech (český jazyk), [VOP Ver2.01]	Can be selected from one of these 2 languages ・English, ・Japanese (日本語), [VOP Ver2.00 or lower]

◆ Setting method . . . select [Menu], [03 System setting] then [01 Language].

(In case the [01 controller] option is selected from the [01 Language] option list, the language will be set to Japanese if the SJ-P1 model number ends in -LFF or HFF, or it will be set to English if the SJ-P1 model number ends in -HFEF, -LFUF or HFUF.)

[2] Supplementary cautions

The following modifications were made on the Ver.2.01 based on the Ver.2.00. If settings related to the modifications described below were being used on the Ver.2.00 or lower, then is necessary to reexamine the configuration of these settings.

No.	Content	Item	Ver.2.01	Ver.2.00 or lower
1	Output range modification of the Ao1, Ao2 analog output terminals when used as current outputs.*1	Output current range*2	0~20mA	4~20mA
2	Output logic modification of the Speed deviation over (DSE) output signal.*3 (bb-83 : Speed deviation error detection level)	While stopped	OFF	OFF
		Operating at (bb-83) level or less	OFF	ON
		Operating at more than (bb-83) level	ON	OFF

*1) Please reexamine the setting of the bias adjustment Cd-23/Cd-33 and the gain adjustment Cd-24/Cd-34.

*2) Assuming Cd-23/Cd-33=0.0% and Cd-24/Cd-34=100.0%.

*3) If the same specification as the Ver.2.00 is required, then configure the logical calculation function (CC-40~CC-60) to calculate the XOR of the Speed deviation over (DSE) and the Running (RUN) output signals, then use the logical operation result (LOG) output signal as the Speed deviation over (DSE) output signal. In this case, the speed deviation error detection time setting should be done by using the output terminal off-delay time parameters (CC-21, 23, 25, 27, 29, 31, 33). (In this case the speed deviation error detection time parameter (bb-84) must be set to 0.0s)

21.3.3 Changes in Ver. 2.02

The following explanations are the contents implemented by the update in the Ver. 2.02.

[1] Operation panel VOP language support expansion (10 languages support)

Ver.2.02 [VOP Ver. 2.02]	Ver.2.01 [VOP Ver.2.01]
<p>The language can be selected from the 10 options shown below</p> <ul style="list-style-type: none"> · English · Japanese(日本語) · French(Français) · Spanish (Español) · Turkish(Türkçe) · Polish(język polski) · Czech(češský jazyk) · German(Deutsch) ※New addition · Italian(Italiano) ※New addition · Dutch(Nederlands) ※New addition 	<p>The language can be selected from the 7 options shown below</p> <ul style="list-style-type: none"> · English · Japanese(日本語) · French(Français) · Spanish (Español) · Turkish(Türkçe) · Polish(język polski) · Czech(češský jazyk)

◆Setting method · · · select [Menu]→[07 System setting]→[01 Language] then choose one of the options shown above.

In case the [01 Controller] option is selected from the [01 Language] option list, the language will be set to Japanese if the SJ-P1 model number ends in -LFF or HFF, or it will be set to English if the SJ-P1 model number ends in -HFEF, -LFUF or HFUF.

[2] Operation panel VOP menu addition

4 types of function specific parameter menus were added.

Ver.2.02 [VOP Ver.2.02]	Ver.2.01 [VOP Ver.2.01]
<p>The following 7 menus are available</p> <ul style="list-style-type: none"> ·01 Scroll mode ·02 User mode ※New addition ·03 Short menu ※New addition ·04 Compare mode ※New addition ·05 Motor setup ※New addition ·06 Read/Write ·07 System setting 	<p>The following 3 menus are available</p> <ul style="list-style-type: none"> ·01 Scroll mode ·02 Read/Write ·03 System setting

※The operation method and details of the 02 to 05 menus are explained in the section [5].

Or please refer to each section of “9.10.3”, “9.10.5”, “9.10.6”, “9.10.7” in "Chapter 9 Operating".

[3] Parameter addition and specification changes

The addition of new parameters and specification changes of existent parameters were implemented as shown in the tables below.

· New parameter addition

Code	Name	Data range	Initial Value	Details
HC115	Torque conversion method selection, 1st-motor	00(Torque)/01(Current)	00	Torque reference percentage value selection
HC215	Torque conversion method selection, 2nd-motor			
oH-40	DeviceNet node address (MAC ID)	0 to 63	0	DeviceNet option designated parameters
oH-41	DeviceNet assembly instance number selection	00(Instance 20 and 70) / 01(Instance 21 and 71) / 02(Instance 100 and 150) / 03(Instance 101 and 151) / 04(Instance 101 and 153) / 05(Instance 110 and 111) / 06(Instance 123 and 173) / 07(Instance 139 and 159)	00	
oH-42	DeviceNet speed unit selection	00(Hz) / 01(min ⁻¹)	01	
oH-44	DeviceNet flexible Gr. Format selection	00(Gr. A) / 01(Gr. B) / 02(Gr. C)	00	
oH-45	DeviceNet idle mode action selection	00(error) / 01(Decel-Trip) / 02(Ignore) / 03(Free run stop) / 04(Decel stop)	00	

· Parameter specification changes

Code	Name	Ver.2.02	Ver.2.01
AH-80	PID soft start time	Data range 0.00 to 600.00 (sec)	Data range 0.00 to 100.00 (sec)
CC-06	Output terminal [16] function	Initial value 00 (no)	Initial value 40 (ZS)
Cd-34	[Ao2] Gain adjustment	Initial value 80.0 (%)	Initial value 100.0 (%)
Hb146	Eco drive response adjustment, 1st motor	No unit display	[%] displayed as unit
Hb246	Eco drive response adjustment, 2nd motor		

[4] Positioning Speed limit specification change

The speed limit setting for each positioning operation was changed as shown in the table below.

Positioning operation	Ver.2.02	Ver.2.01 Speed limit
Positioning of the orientation function	[AE-12] Speed reference of home search function *1)	[AE-66] Speed limit in APR control
Positioning of the homing function	[AE-72] Low-speed homing speed setting *1)	[AE-66] Speed limit in APR control

*1) The behavior is the same as the SJ700 inverter

[5] Explanation of the new added menus

(1) User mode

- The user mode will display user-registered parameters only. This will allow to quickly access the parameters that are frequently used or are essential to the user.
- Select the "02 User mode" option from the menu screen, then press the SEL(O) to display the main user mode screen.

[Main user mode screen]

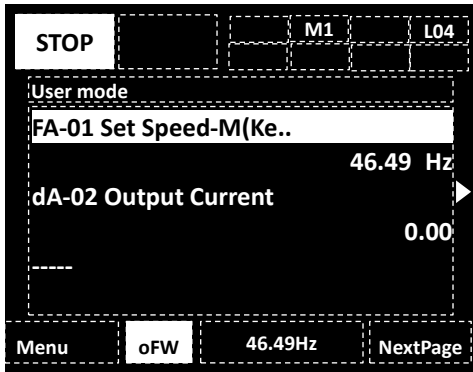

·This user mode screen displays the parameters that have been previously registered on the user parameters [UA-31] to [UA-62] in that order. (「-----」 will be displayed in case there is no registered parameter)

※User mode parameter registration

- By pressing the RIGHT (▷) button, the screen will move to the parameter registration screen where the parameters UA-31 to UA-62 are displayed.

User mode screen(parameter registration screen)

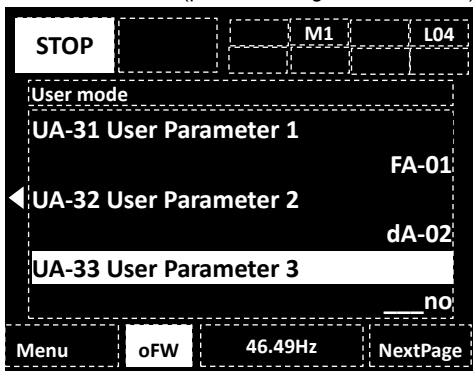

- Use the UP/DOWN(△▽) or the F2 key (Next page) to select the required user parameter then press the SEL(O) to display the parameter setting screen, then search and register the required parameter.
- Registering a non-existent parameter will release the registration in that user parameter (「___no」 will be shown instead).

(2) Short menu

- The short menu displays regularly used parameters for the inverter operation allowing the user to configure the inverter more quickly and efficiently.
- Select the "03 Short menu" option from the menu screen, then press the SEL(O) to display the short menu screen.

[Short menu Screen]

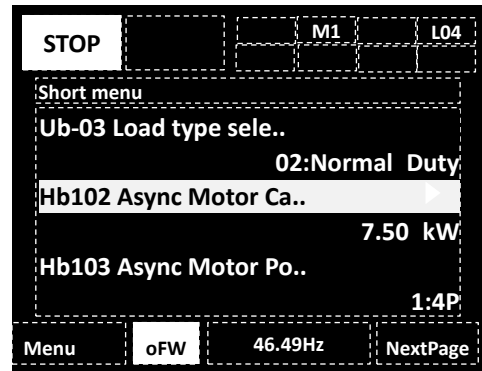

·The short menu will display the parameters shown in the table below. (These are pre-defined parameters for the short menu)

※Short menu pre-defined parameters

No	Code	Name
1	Ub-03	Load type selection
2	Hb102	Async. Motor capacity setting, 1st-motor
3	Hb103	Async. Motor number of poles setting, 1st-motor
4	Hb104	Async. Motor base frequency setting, 1st-motor
5	Hb105	Async. Motor maximum frequency setting, 1st-motor
6	Hb106	Async. Motor rated voltage, 1st-motor
7	Hb108	Async. Motor rated current, 1st-motor
8	bC110	Electronic thermal level setting, 1st-motor
9	AA121	Control mode selection, 1st-motor
10	bb101	Carrier frequency setting, 1st-motor
11	AA101	Main speed input source selection, 1st-motor
12	AA111	Run command input source selection, 1st-motor
13	AC120	Acceleration time setting 1, 1st-motor
14	AC122	Deceleration time setting 1, 1st-motor
15	AA115	STOP mode selection, 1st-motor
16	Ab110	Multis-peed 0 setting, 1st-motor
17	Ab-11	Multis-peed 1 setting
18	Ab-12	Multis-peed 2 setting
19	Ab-13	Multis-peed 3 setting
20	bA101	Upper frequency limit source selection, 1st-motor
21	bA102	Upper frequency limit, 1st-motor
22	bA103	Lower frequency limit, 1st-motor
23	Cb-40	Thermistor type selection
24	CC-07	Output terminal [AL] function
25	CC-06	Output terminal [16] function
26	bA-61	Dynamic brake activation selection
27	bA-60	Dynamic brake use ratio
28	bA-63	Dynamic brake resistor value

※The number in the No. column represents the short menu display order

(3) Compare mode

- The compare mode will only display the parameters that have been modified from its initial settings, allowing the user to quickly verify or modify the implemented changes.
- Select the "04 Compare mode" option from the menu screen, then press the SEL(O) to display the compare mode screen.

Compare mode screen

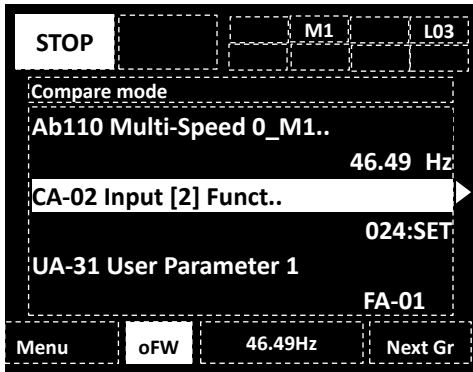

- The compare mode will not display the parameters that have not been modified from their initial settings. Additionally this mode will not display any monitor parameters (Groups d and F).

(4) Motor setup menu

- The motor setup menu displays the parameters that are related to a basic motor setting, allowing the user to quickly configure the inverter to operate a motor.
- Select the "05 Motor setup" option from the menu screen, then press the SEL(O) to display the motor setup screen.

Motor setup screen

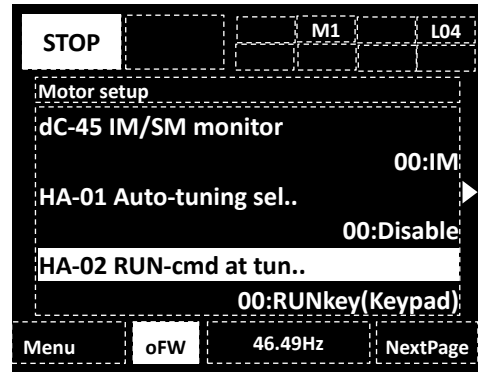

- The motor setup menu will display the parameters shown in the table below. (These are pre-defined parameters for the motor setup menu)

※Motor setup pre-defined parameters

No	Code	Name	No	Code	Name
1	dC-45	IM/SM monitor	21	Hd104	Sync. Motor Base frequency setting, 1st-motor
2	HA-01	Auto-tuning selection	22	Hd105	Sync. Motor Maximum frequency setting, 1st-motor
3	HA-02	Auto-tuning RUN command source selection	23	Hd106	Sync. Motor rated voltage, 1st-motor
4	HA-03	Online auto-tuning selection	24	Hd108	Sync. Motor rated current, 1st-motor
5	Hb102	Async. Motor capacity setting, 1st motor	25	Hd110	Sync. Motor constant R, 1st-motor
6	Hb103	Async. Motor number of poles setting, 1st-motor	26	Hd112	Sync. Motor constant Ld, 1st-motor
7	Hb104	Async. Motor Base frequency setting, 1st-motor	27	Hd114	Sync. Motor constant Lq, 1st-motor
8	Hb105	Async. Motor Maximum frequency setting, 1st-motor	28	Hd116	Sync. Motor constant Ke, 1st-motor
9	Hb106	Async. Motor rated voltage, 1st-motor	29	Hd118	Sync. Motor constant J, 1st-motor
10	Hb108	Async. Motor rated current, 1st-motor	30	Hd130	Minimum frequency adjustment for Sync.M, 1st-motor
11	Hb110	Async. Motor constant R1, 1st-motor	31	Hd131	No-Load current for Sync.M, 1st-motor
12	Hb112	Async. Motor constant R2, 1st-motor	32	Hd132	Starting method for Sync. M., 1st-motor
13	Hb114	Async. Motor constant L, 1st-motor	33	Hd133	IMPE 0V wait number for Sync. M., 1st-motor
14	Hb116	Async. Motor constant I0, 1st-motor	34	Hd134	IMPE detect wait number for Sync. M., 1st-motor
15	Hb118	Async. Motor constant J, 1st-motor	35	Hd135	IMPE detect number for Sync. M., 1st-motor
16	HA110	Stabilization constant, 1st-motor	36	Hd136	IMPE voltage gain for Sync. M., 1st-motor
17	HA115	Speed response, 1st-motor	37	Hd137	IMPE Mg-pole position offset, 1st-motor
18	Hb180	Ouput voltage gain, 1st-motor			
19	Hd102	Sync. Motor capacity setting, 1st motor			
20	Hd103	Sync. Motor number of poles setting, 1st-motor			

※The number in the No. column represents the motor setup menu display order

21.3.4 Changes in Ver. 2.03

The following explanations are the contents implemented by the update in the Ver. 2.03.

[1] Added parameters

The following table shows the parameters added in this version upgrade.

Code	Name	Range	Initial Value	Description
bb-50	Frequency matching filter gain	0 to 1000(%)	50	This adjusts the frequency acquisition process filter used during a frequency matching restart.
HA112	Stabilization ramp function end ratio, 1st-motor	0 to 100(%)	30	These adjust the stabilization constant-output frequency characteristic curve
HA212	Stabilization ramp function end ratio, 2nd-motor			
HA113	Stabilization ramp function start ratio, 1st-motor	0 to 100(%)	10	
HA213	Stabilization ramp function start ratio, 2nd-motor			
HC137	Flux settling level, 1st-motor	0.0 to 100.0(%)	80.0	These adjust the magnetic flux settling level at the start of the operation
HC237	Flux settling level, 2nd-motor			
HC140	Forcing level, 1st-motor	0 to 1000(%)	100	These adjust the output current when the forcing function is active
HC240	Forcing level, 2nd-motor			
HC141	Modulation threshold 1, 1st-motor	0 to 133(%)	115	These adjust the upper limit of the output voltage
HC241	Modulation threshold 1, 2nd-motor			
HC142	Modulation threshold 2, 1st-motor	0 to 133(%)	115	
HC242	Modulation threshold 2, 2nd-motor			

(1) Frequency matching filter gain [bb-50]

This parameter is used to adjust the filter that is implemented in the motor frequency acquisition process during a frequency matching restart. By decreasing this parameter value the filter time constant increases. The filter will be disabled in case this parameter value is set to 0%. By adjusting this parameter, the operation of the frequency matching restart may be improved in cases where the restart operation is unstable.

(2) Stabilization ramp function start ratio [HA113/213], end ratio [HA112/212]

These parameters are used to adjust the stabilization constant - output frequency characteristic curve. When the output frequency is below the start ratio the stabilization constant is 0%, and when it exceeds the end ratio the stabilization constant becomes the [HA110/210] set value. Between the start and end ratio the stabilization constant increases from 0 to [HA110/210] proportionally to the output frequency. See the figure below.

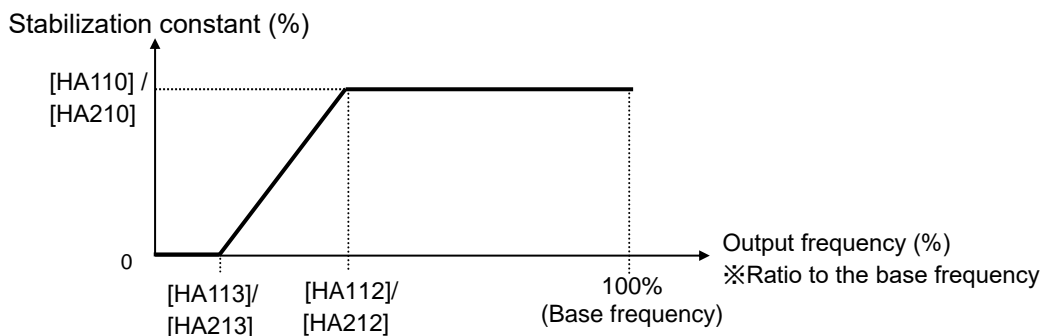

Note) Make sure that the start ratio value is lower than the end ratio value when adjusting these parameters. In case the end ratio is lower than the start ratio, the end ratio setting will be ignored and the start ratio value will be assigned to both the start and end ratio values.

(3) Flux settling level [HC137/237]

These parameters are used to adjust the magnetic flux settling level at the start of the operation. Since the acceleration begins when the magnetic flux has reached the level set by these parameters at the start of the operation, the waiting time until the acceleration begins is decreased by setting a smaller value to these parameters. However, changing the setting of these parameters can destabilize the start of the operation. These parameter settings are effective only when the control mode selection [AA121/221] is set to either 08: Sensorless vector control (IM), 09: Zero-Hz-range sensorless vector control (IM), or 10: Vector control with encoder (IM).

(4) Forcing level [HC140/240]

These parameters are used to adjust the output current level while the forcing function is active. These parameter settings are effective only when the control mode selection [AA121/221] is set to either 08: Sensorless vector control (IM), 09: Zero-Hz-range sensorless vector control (IM), or 10: Vector control with encoder (IM). And the basis of these parameters [HC140/240] is applied by the parameters shown in the following table.

Control mode	basis of [HC140/240]
Sensorless vector control (IM), Vector control with encoder (IM)	[Hb116/216] Async. Motor constant I0
Zero-Hz-range sensorless vector control	[HC110/210] Zero speed range limit (IM -0Hz-SLV)

In the case the Zero-Hz-range sensorless vector control is being used, and the forcing current is high, the forcing current can be reduced by setting these parameters small.

(5) Modulation threshold 1,2 ([HC141/241], [HC142/242])

These parameters are used to adjust the upper limit of the inverter output voltage.

By increasing these parameter values the output current can be reduced. However by applying these settings, the operation can become unstable.

Additionally, always make sure that the [HC141] and [HC142] are set to the same value in case these parameter settings need to be changed (same for the 2nd motor parameters [HC241] and [HC242]).

These parameter settings are effective only when the control mode selection [AA121/221] is set to either 08: Sensorless vector control (IM), 09: Zero-Hz-range sensorless vector control (IM), or 10: Vector control with encoder (IM).

[2] Added pulse train position control and speed control switching function

When the pulse train position control is enabled ([AA123/223]=01), the control method can be switched to speed control by the [SPD] terminal function.

Changed operation	Ver.2.03	Ver.2.00 to 2.02
The [SPD] terminal effect regarding the pulse train position control	By turning ON or OFF the [SPD] terminal the control method is switched as shown below. <ul style="list-style-type: none"> •When [SPD] is OFF : Pulse train position control •When [SPD] is ON : Speed control <p>※While the [SPD] is ON the Pulse train position deviation is 0. Hence when changing the [SPD] from ON to OFF, the deviation is 0 at the beginning of the position control operation.</p>	[SPD] terminal has no effect.

[3] Modification of the positioning completed signal [POK] output condition_

The reference position for the positioning completed signal [POK] is modified as shown below.

Changed operation	Ver.2.03	Ver.2.00 to 2.02
The reference position for the [POK] output signal regarding the absolute position control	The [POK] signal is output when the aimed target position is reached. In the homing function, the aimed target position is the origin (point zero). In the [SON] function, the aimed target position is the position where the [SON] signal is turning on.	The reference for the [POK] output signal is set by the position reference setting [FA-20].

21.4 STO Terminal Functions

21.4.1 Safety Function, STO (Safe Torque Off)

- The SJ Series P1 is equipped with the STO (Safe torque off) function defined in IEC61800-5-2. This function is equivalent to stop category 0 defined in EN/IEC60204-1.
- **The section describes only the functions of STO terminals. If this product is handled as a product with certification of safety function, make sure to check the SJ-P1 Safety Function Guide separately provided, and perform work (verification, validity confirmation, etc.) required for a functional safety system. The contents described in the SJ-P1 Safety Function Guide shall take precedence.**

21.4.2 Operation Procedure of Safety Function

■ STO input terminal

- Input of STO signal is performed by redundant input of STO terminals ST1 and ST2.
- When voltage is applied to each input terminal and current flows, operation of safety path is enabled. (When shipped from the factory, operation is always enabled. See the figure below.)
- If voltage is not applied to at least one of the input terminals, the corresponding blocking path shuts off output of the inverter.

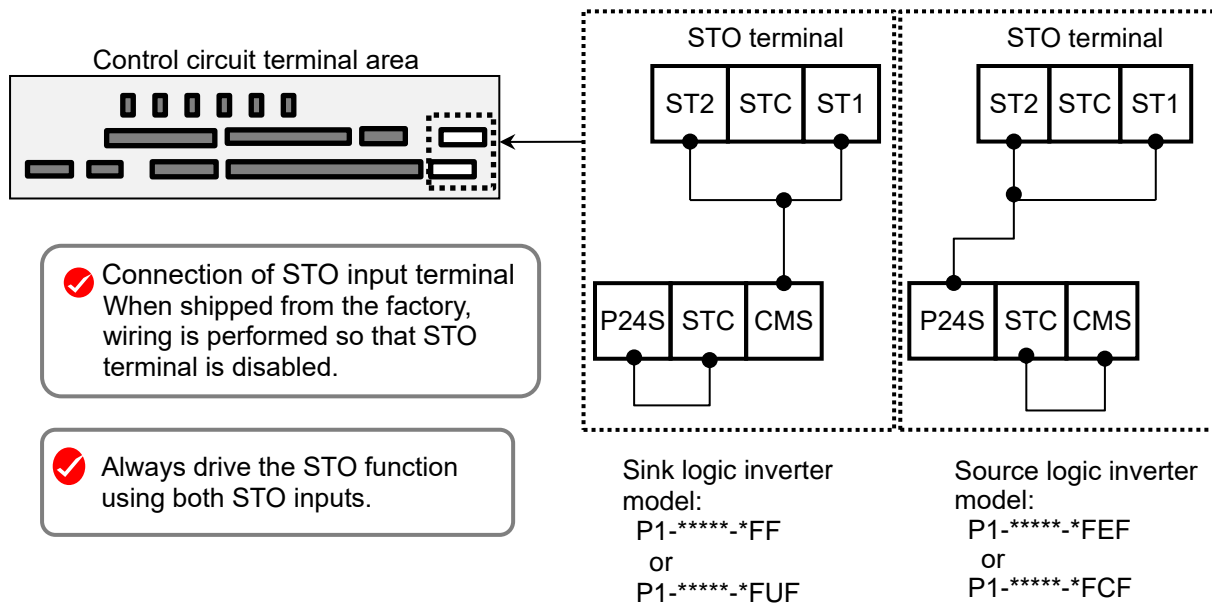

■ Terminal specifications

Terminal symbol	Terminal name	Description	Electrical characteristics
P24S	24V output terminal (for STO input only)	A DC24V power supply for contact signals dedicated for ST1/ST2 terminals. The common terminal is CMS.	Maximum output current: 100mA
CMS	24V output terminal common (for STO input only)	A common terminal for DC24V power supply for contact signals dedicated for ST1/ST2 terminals.	
STC	Input logic switching terminal	A logic switching terminal for STO input. You can change the input logic changing the connecting point of short-circuit line. When an external power supply is used, remove the short-circuit line and use this terminal as the input common for ST1/ST2	<for sink logic> Short-circuit line: Connect between P24S and STC <For source logic> Short-circuit line: Connect between CMS and STC
ST1/ST2	STO input terminal	An input terminal of STO.	Voltage between ST1 and STC/ST1 and STC <ul style="list-style-type: none"> • ON voltage: Min.15 VDC • OFF voltage Max. 5 VDC • Maximum allowable voltage 27 VDC • Load current 5.8mA (at 27 VDC) Internal resistance: 4.7 kΩ
ED+	EDM signal output terminal (+)	A plus terminal of EDM signal (STO status monitoring).	Open collector output <ul style="list-style-type: none"> • Between ED+ and ED- • Voltage drop at ON: 4 V or less • Maximum allowable voltage: 27 V • Maximum allowable current: 50 mA
ED-	EDM signal output terminal (-)	A minus terminal of EDM signal (STO status monitoring).	

21.4.3 Input Method of STO Signal

- Input voltage for the STO signal can be chosen from the internal power supply of inverter (P24S terminal) or an external 24 VDC power supply.

- Also, by changing the connecting point of short-circuit line, you can choose input logic from sink and source.
- By turning off the external switch (contact point) for STO input shown in the wiring example below, STO function is enabled, and output to the motor is shuts off.

■ Wiring example

■ Internal power supply+Sink logic

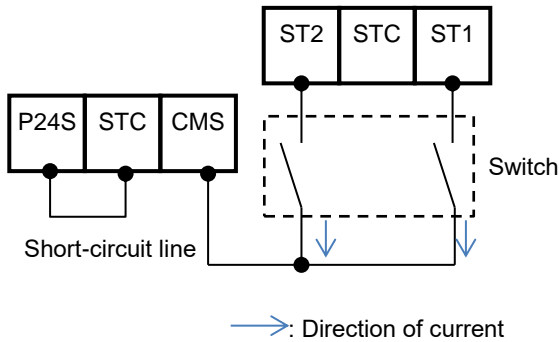

■ Internal power supply+Source logic

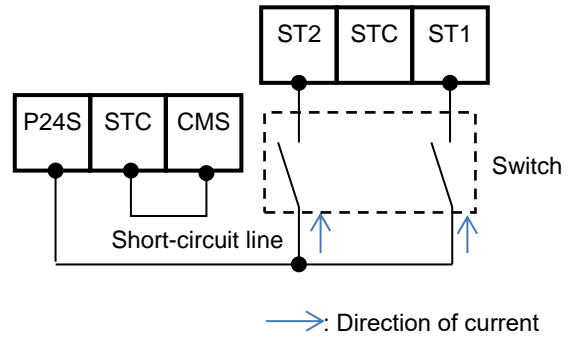

■ External power supply+Sink logic

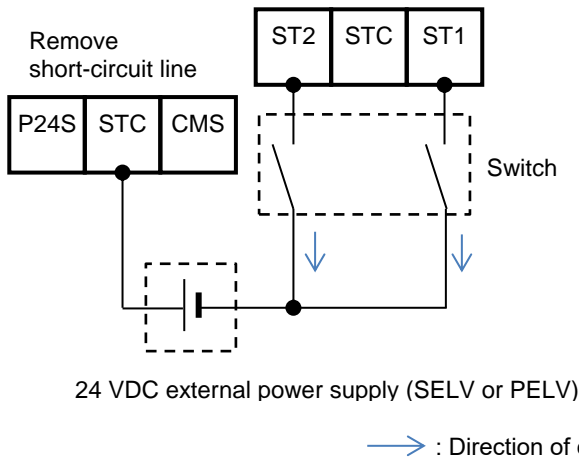

■ External power supply+Source logic

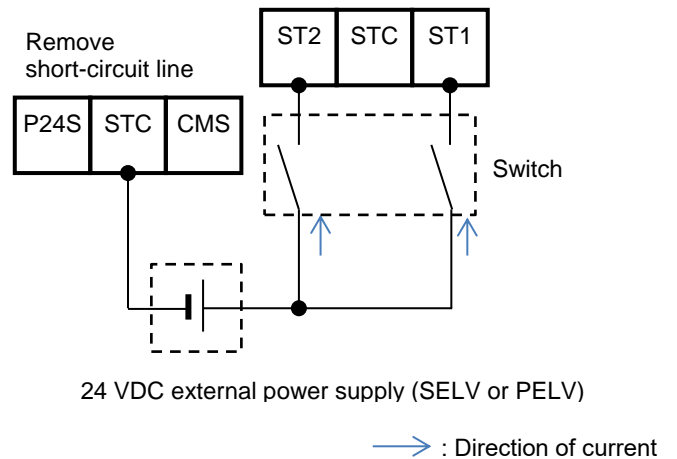

21.4.4 STO Status Retention Function

The retention function that retains the blocked status of internal safety path even if STO input is canceled is not implemented as a safety circuit.

Therefore, if an operation command is input after cancellation of STO input or STO input is canceled while it is input, the inverter starts output to the motor. Hence, to satisfy the requirement about cancellation of emergency stop specified in EN/IEC60204-1, you need to take either of the following measures.

- (1) At the same time as STO input, set the operation command to the inverter to stopped status
- (2) Configure the system so that STO input to SJ-P1 is canceled when system reboot is required by the user.



By setting parameters of the main unit, you can select the following operations.

(see “21.4.7 Status Indication Function”.)

- (1) Trip the inverter by STO input. In this case, the inverter is tripped and output is stopped until power is shut off or the error reset signal for the inverter is input.
- (2) If two STO input systems to the inverter are not input at the same time, the inverter is shut off and enters standby mode until STO input for the two systems is input.

21.4.5 STO Confirmation Signal Output (EDM Signal)

The STO confirmation signal output (EDM output) is the output signal for monitoring the input status of STO signal and failure detection status on the internal safety path.

■ EDM terminal (ED+ / ED-) and wiring example

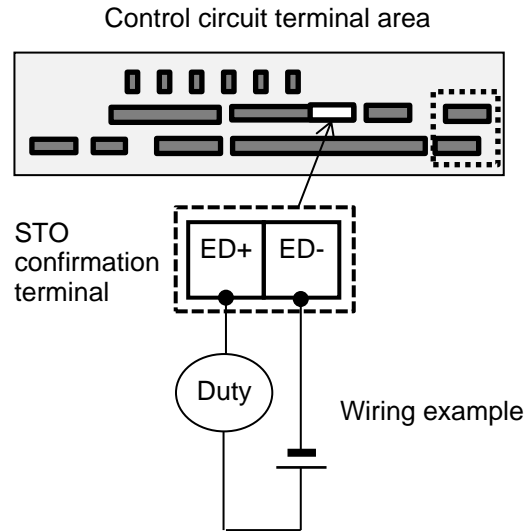

For operation of ST1/St2 and output of STO confirmation signal against failure detection status, see the matrix below. EDM turns ON only when both STO inputs are correctly input and internal failure is not detected.

■ Signal matrix

Signal	Status 1	Status 2	Status 3	Status 4	Status 5
ST1 *1)	STO	Operation permitted	STO	Operation permitted	*
ST2 *1)	STO	STO	Operation permitted	Operation permitted	*
Failure detection	None	None	None	None	Detected
EDM	ON	OFF	OFF	OFF	OFF
Output to the motor	Off	Off	Off	Output permitted	Off

*1) The following table shows the correspondence between the input status of ST1/ST2 described in the table above and status of contact points.

Input status	Contact point
STO	OFF
Operation permitted	ON

21.4.6 Timing Diagram

The following shows the timing diagram of output to the motor and output of EDM signals for STO inputs ST1/ST2.

■ Timing Diagram

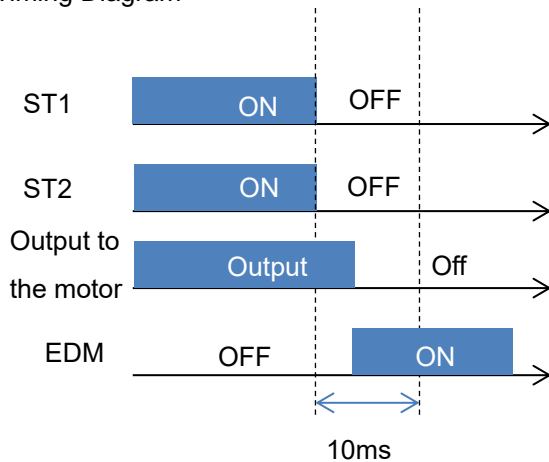

21.4.7 Status Indication Function

By setting parameters described in the table below, you can STO input status on the control panel screen. You can also check the status by checking the monitor parameter [dA-45].

■ Parameters related to STO function indication

Item	Parameter	Data	Description
STO input display selection	[bd-01]	00	If input of both ST1 and ST2 is STO (input contact point is OFF), "STO" is shown on the control panel screen.
		01	Also if input of both ST1 and ST2 is STO (input contact point is OFF), "STO" is not shown on the control panel.
		02	If input of both ST1 and ST2 is STO (input contact point is OFF), [E090] error occurs. * Even if either ST1 and ST2 is set to STO, [E090] error does not occur.
STO input change time	[bd-02]	0.00~60.00 (s)	Set the allowable time during which input status of ST1 and ST2 is different (e.g., input contact point: ST1=ON, ST2=OFF). If there is a difference between the switching time of ST1 and that of ST2, set the maximum allowable time the difference can be generated. If it is set to 0.00, the determination of allowable time becomes invalid.
Display selection during STO input change time	[bd-03]	00	Displays a warning at the time difference of status occurs between ST1 and ST2 until the STO allowable input switch time configured in [bd-02] has elapsed.
		01	Does not display a warning at the time difference of status occurs between ST1 and ST2 until the STO allowable input switch time configured in [bd-02] has elapsed.
Action selection after STO input change time	[bd-04]	00	Displays a warning after the STO allowable input switch time configured in [bd-02] has elapsed.
		01	Does not display a warning after the STO allowable input switch time configured in [bd-02] has elapsed.
		02	After the STO allowable input switch time configured in [bd-02] has elapsed, [E092] or [E093] error occurs.

■ [dA-45] Safety STO monitor and status indication on the upper right of the operator keypad

STO monitor [dA-45] data display contents	(Status indication on the upper right of the operator keypad)	Condition	Description
00:Non	(No indication)	<1>	Operation is permitted on both ST1 and ST2 (contact point is ON) and inverter output is available.
01:P-1A	P-1A	<2>	When operation is permitted on both ST1 and ST2 (contact point is ON), only ST2 changes to STO (contact point is OFF). Then, operation is permitted (contact point is ON) on ST1 again for the entire STO switch allowable time [bd-02].
02:P-2A	P-2A	<3>	When operation is permitted on both ST1 and ST2 (contact point is ON), only ST1 changes to STO (contact point is OFF). Then, operation is permitted (contact point is ON) on ST1 again for the entire STO switch allowable time [bd-02].
03:P-1b	P-1b	<5>	(1) The P-1A or P-1b status is kept until the STO switch allowable time [bd-02] has elapsed. (2) When operation is permitted on both ST1 and ST2 (contact point is ON), only ST2 changes to STO (contact point is OFF), and then the operation is permitted (contact point is ON) again.
04:P-2b	P-2b	<6>	(1) The P-12 or P-2b status is kept until the STO switch allowable time [bd-02] has elapsed. (2) When operation is permitted on both ST1 and ST2 (contact point is ON), only ST1 changes to STO (contact point is OFF), and then the operation is permitted (contact point is ON) again.
05:P-1C	P-1C	<7>	From the status that both ST1 and ST2 is STO (contact point is ON), operation is permitted (contact point is ON) only on ST2. Then, ST1 is at STO (contact point is OFF) again for the entire STO switch allowable time [bd-02].
06:P-2C	P-2C	<8>	From the status that both ST1 and ST2 is STO (contact point is ON), operation is permitted (contact point is ON) only on ST2. Then, ST1 is at STO (contact point is OFF) again for the entire STO switch allowable time [bd-02].
07:STO	STO	<4>	Both ST1 and ST2 are at STO (contact point is OFF).

■ Error indication

Item	Error	Condition	Description
STO shutoff error	[E090]	<9>	If [bd-01] is set to 02, the error occurs when both ST1 and ST2 are input.
STO internal error	[E091]	<10>	The error occurs when internal failure is found. It cannot be canceled by reset operation.
STP path 1 error	[E092]	<11>	If [bd-04] is set to 02, the error occurs at [P-1b].
STP path 2 error	[E093]	<12>	If [bd-04] is set to 02, the error occurs at [P-2b].

■ Status transition

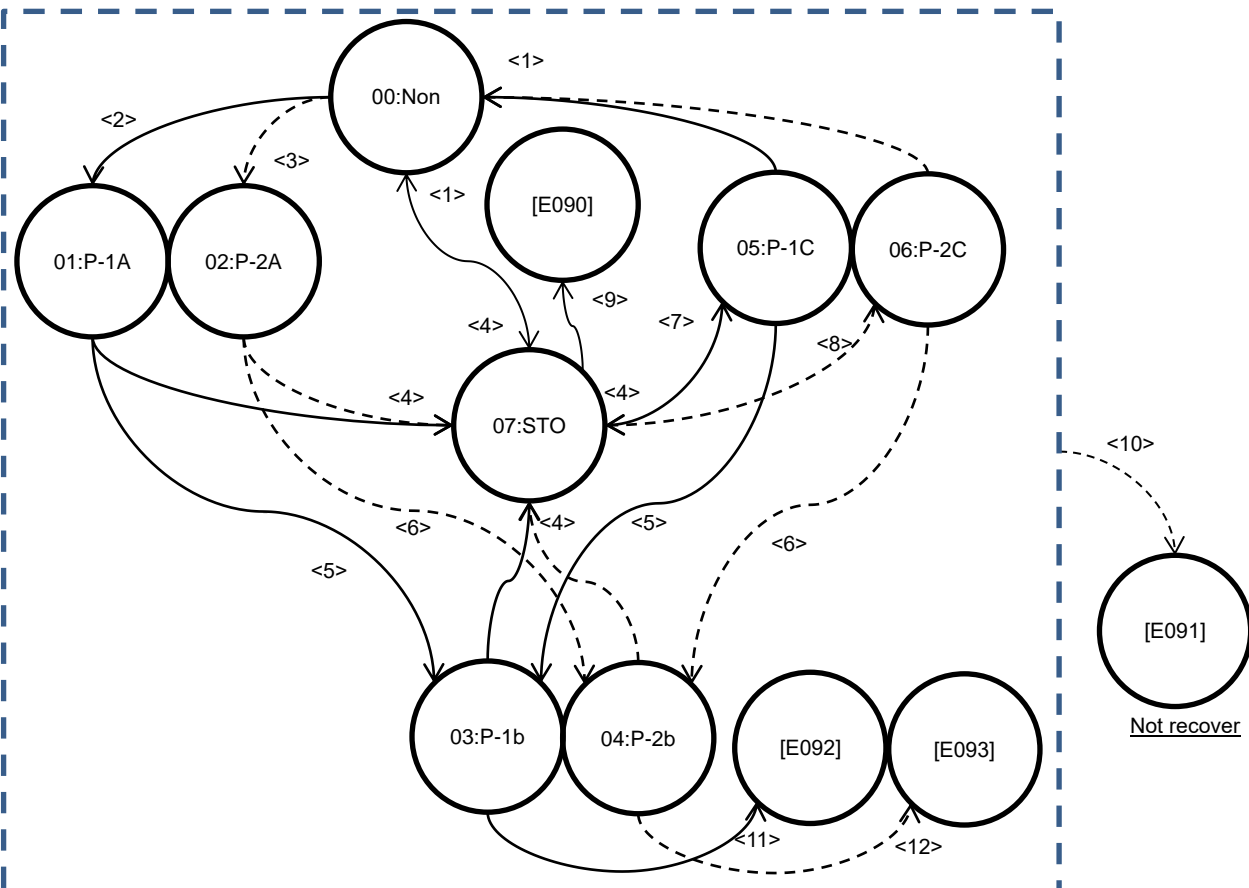

(Note: At reset, the status returns to "00:Non".)

(memo)

Appendix 1

Appendix 1 List of Parameters

Contents

- A1.1 What This Chapter Explains.....Appendix 1-1
- A1.2 How to View Parameters and Lists..Appendix 1-1
- A1.3 List of Monitor Modes.....Appendix 1-3
- A1.4 List of Parameter ModesAppendix 1-8

A1.1 What This Chapter Explains

This chapter describes lists of monitors and parameters as well as setting range of each parameter and their initial values.

A1.2 How to View Parameters and Lists

■ Structure of parameter code.

- A parameter consists of a parameter group, switch recognition number assigned by the 024[SET] terminal function, and an in-group number.
- If the switch recognition number assigned by 024[SET] terminal function is “-”, it is enabled in both first setting and second setting.

- If the 024[SET] function is not set to the input terminal functions [CA-01] to [CA-11], the first setting is valid.

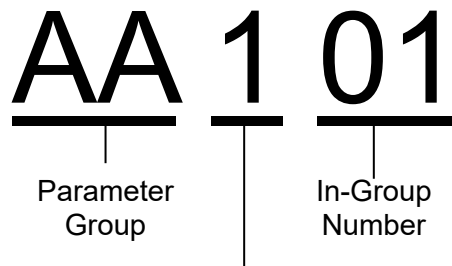

- : Always enabled in both the first setting and second setting.
- 1: Enabled in the first setting when the [SET] terminal function is OFF.
- 2: Enabled in the second setting when the [SET] terminal function is ON.

■ About monitor mode.

Code	Name	Data range	Page
XX-01	Monitor name	Data Range	Reference page

■ About parameter mode.

Code	Name	Data range	Initial value	Note	Page
YY101	Parameter name	Data range	ZZ (*FF)/ UU (*FEF) (*FUF) (*FCF)	(Write down the setting value)	Reference page
<u>YY-02</u>	Parameter name	(200V class) data range (400V class) data range	(200V class) VV (400V class) WW	(Write down the setting value)	Reference page

Codes that can be changed during operation are underlined.

- The voltage class is shown by 200V/400V.
- See "Chapter 20 Specifications" for the product model.
The description applies to all models unless otherwise specified.

- If the initial value differs depending on the destination, symbols (JPN)/(EU · ASIA)/(USA)/(CHN) are separately described. If there is no description, the initial value is the same for all destinations.
- Models correspond with the following destinations.
 - P1-*****-*FF (*FF):(JPN)
 - P1-*****-*FEF (*FEF):(EU, ASIA)
 - P1-*****-*FUF (*FUF):(USA)
 - P1-*****-*FCF (*FCF):(CHN)
- * Parameters other than those changeable during operation can be changed only when the device is stopped. The user can change the parameter that cannot be changed during operation after the device decelerates and stops and output is stopped. However, it cannot be changed if the soft-lock function is activated.
- The text includes notes with a symbol "*")".

■ Notes on setting parameters.



Do

- When setting parameters, we expect you to fully understand various points to be noted.
- Make sure to check and set the following parameters to protect the motor:
 - [Hb102] to [Hb108] (For IM);
 - [Hb110] to [Hb118] (For IM vector control);
 - [Hd102] to [Hd108] (For SM/PMM);
 - [Hd110] to [Hd118] (For SM/PMM vector control);
 - [bC110] (Electronic thermal level setting)
 - for motor overload protection current;
 - [bb160] (Overcurrent detection level).
- * When setting the thermal subtraction characteristics, set a value in accordance with the characteristics of motor. Otherwise, the motor may be burned.

After configuring settings for motor protection, choose the frequency command destination and operation command destination to run the device.

- With [AA101], choose a frequency command destination.
- With [AA111], choose an RUN command destination.
- With [FA-01], the frequency command value can be checked.
- *) To run the inverter, a frequency command and RUN command are required.
If the control mode is V/f mode, NO output to the motor when frequency command is 0 Hz.

A1.3 List of Monitor Modes

■ Monitors related to output.

Code	Name	Data range	Page
dA-01	Output frequency monitor	0.00 to 590.00 (Hz)	13-2
dA-02	Output current monitor	0.00 to 655.35 (A) (P1-550L / P1-1320H or smaller) 0.0 to 6553.5 (A) (P1-1600H or larger)	13-9
dA-03	Rotation direction monitor	0(Stop)/ 1(0Hz output)/ 2(Forward)/ 3(Reverse)	13-7
dA-04	Frequency reference monitor (after calculation) *1)	-590.00 to 590.00 (Hz)	13-3
dA-06	Output frequency scale conversion monitor	0.00 to 59000.00	13-4
dA-08	Detect speed monitor	-590.00 to 590.00 (Hz)	13-5
dA-12	Output frequency monitor (signed)	-590.00 to 590.00 (Hz)	13-2
dA-14	Frequency upper limit monitor	0.00 to 590.00 (Hz)	12-6-1
dA-15	Torque reference monitor (after calculation) *1) *2)	-1000.0 to 1000.0 (%)	12-11-15
dA-16	Torque limit monitor *2)	0.0 to 500.0 (%)	12-11-9
dA-17	Output torque monitor *2)	-1000.0 to 1000.0 (%)	12-11-9
dA-18	Output voltage monitor (RMS)	0.0 to 800.0 (V)	13-10
dA-20	Current position monitor	When [AA121]≠10 or [AA123]≠03 -536870912 to +536870911 (pls) / When [AA121]=10 and [AA123]=03 -2147483648 to +2147483647 (pls)	12-17-18 12-17-31
dA-26	Pulse train position deviation monitor	-2147483647 to 2147483647 (pls)	12-17-18
dA-28	Pulse count monitor	0 to 2147483647	12-24-16
dA-30	Input power monitor	0.00 to 655.35 (kW) (P1-550L / P1-1320H or smaller) 0.0 to 6553.5 (kW) (P1-1600H or larger)	13-14
dA-32	Accumulated input power monitor	0.0 to 1000000.0 (kWh)	13-14
dA-34	Output power monitor	0.00 to 655.35 (kW) (P1-550L / P1-1320H or smaller) 0.0 to 6553.5 (kW) (P1-1600H or larger)	13-15
dA-36	Accumulated output power monitor	0.0 to 1000000.0 (kWh)	13-15
dA-38	Motor temperature monitor *3)	-20.0 to 200.0 (degrees Celsius)	12-7-6
dA-40	DC bus voltage monitor (P-N voltage)	0.0 to 1000.0 (VDC)	13-10
dA-41	BRD load rate monitor	0.00 to 100.00 (%)	13-19
dA-42	Electronic thermal load rating monitor (Motor)	0.00 to 100.00 (%)	13-18
dA-43	Electronic thermal load rating monitor (Inverter)	0.00 to 100.00 (%)	13-18

*1) (After calculation) means that it is after calculation such as auxiliary speed or addition frequency and calculation such as torque bias.

*2) These torque related functions are valid when the Control mode selection [AA121] / [AA221] is set to 08(IM-SLV), 09(IM-0Hz-SLV), or 10(IM-CLV). [dA-15] is valid at 08 or 10.

*3) Valid only when an NTC type external thermistor is connected. For details, refer to "12.7.2 Monitoring of Motor Temperature".

■ Monitors related to control circuit.

Code	Name	Data range	Page
dA-45	Safety STO monitor	00(no input)/ 01(P-1A)/ 02(P-2A)/ 03(P-1b)/ 04(P-2b)/ 05(P-1C)/ 06(P-2C)/ 07(STO)	21-41
dA-46	Safety option hardware monitor	0000 to FFFF	-
dA-47	Safety option function monitor	00(no input)/ 01(STO)/ 02(SBC)/ 03(SS1)/ 04(SLS)/ 05(SDI)/ 06(SSM)	-
dA-50	Control terminal type	00(P1-TM (standard terminal block)) / 02(P1-TM2 (screw type terminal option) or P1-TM2R (screw type terminal option (Expanded relay)) / 015(Not connect)	13-27
dA-51	Input terminal monitor	LLLLLLLLLLLL to HHHHHHHHHHHH[L:OFF/H:ON] [Left side] (terminal B) (terminal A)·····(terminal 1) [Right side]	13-8
dA-54	Output terminal monitor	LLLLLLL to HHHHHHH [L:OFF/H:ON] [Left side] (terminal AL) (terminal 16)·····(terminal 11) [Right side]	13-8
dA-60	Analog input/output status monitor	AAAAAAAA to VVVVVVVV [A: current/V: voltage] [Left side](terminal Ao4)(terminal Ao3)(terminal Ai5)(terminal Ai4) (terminal Ao2)(terminal Ao1)(terminal Ai2)(terminal Ai1)[Right side]	13-21
dA-61	Analog input [Ai1] monitor	0.00 to 100.00 (%)	13-26
dA-62	Analog input [Ai2] monitor	0.00 to 100.00 (%)	
dA-63	Analog input [Ai3] monitor	-100.00 to 100.00 (%)	
dA-64	Analog input [Ai4] monitor	0.00 to 100.00 (%)	
dA-65	Analog input [Ai5] monitor	0.00 to 100.00 (%)	
dA-66	Analog input [Ai6] monitor	-100.00 to 100.00 (%)	
dA-70	Pulse train input monitor (internal)	-100.00 to 100.00 (%)	12-4-5
dA-71	Pulse train input monitor (option)	-100.00 to 100.00 (%)	12-4-7

■ Option slot monitor.

Code	Name	Data range	Page
dA-81	Option slot-1 status	00:(none)/ 01:(P1-EN)/	13-20
dA-82	Option slot-2 status	02:(P1-ECT)/ 03:(P1-PN)/	
dA-83	Option slot-3 status	05:(P1-DN)/ 06:(P1-PB)/ 07:(P1-CCL)/ 18:(P1-AG)/ 33:(P1-FB:dA-82 only)/ 48:(P1-FS:dA-83 only)	

■ Monitors related to the program function EzSQ.

Code	Name	Data range	Page
db-01	Program download monitor	00(Program is not installed)/ 01(Program is installed)	16-5
db-02	Program No. monitor	0000 to 9999	16-5
db-03	Program counter (Task-1)	1 to 1024	16-5
db-04	Program counter (Task-2)	1 to 1024	16-5
db-05	Program counter (Task-3)	1 to 1024	16-5
db-06	Program counter (Task-4)	1 to 1024	16-5
db-07	Program counter (Task-5)	1 to 1024	16-5
db-08	User monitor-0	-2147483647 to 2147483647	16-5
db-10	User monitor-1	-2147483647 to 2147483647	16-5
db-12	User monitor-2	-2147483647 to 2147483647	16-5
db-14	User monitor-3	-2147483647 to 2147483647	16-5
db-16	User monitor-4	-2147483647 to 2147483647	16-5
db-18	Analog output monitor YA0	0.00 to 100.00 (%)	16-5
db-19	Analog output monitor YA1	0.00 to 100.00 (%)	16-5
db-20	Analog output monitor YA2	0.00 to 100.00 (%)	16-5
db-21	Analog output monitor YA3	0.00 to 100.00 (%)	16-5
db-22	Analog output monitor YA4	0.00 to 100.00 (%)	16-5
db-23	Analog output monitor YA5	0.00 to 100.00 (%)	16-5

■ Monitors related to PID function.

Code	Name	Data range	Page
db-30	PID1 feedback value 1 monitor	-100.00 to 100.00 (%) (Range will depend on [AH-04], [AH-05], [AH-06])	12-10-7
db-32	PID1 feedback value 2 monitor		
db-34	PID1 feedback value 3 monitor		
db-36	PID2 feedback value monitor	-100.00 to 100.00 (%) (Range will depend on [AJ-04], [AJ-05], [AJ-06])	12-10-25
db-38	PID3 feedback value monitor	-100.00 to 100.00 (%) (Range will depend on [AJ-24], [AJ-25], [AJ-26])	
db-40	PID4 feedback value monitor	-100.00 to 100.00 (%) (Range will depend on [AJ-44], [AJ-45], [AJ-46])	
db-42	PID1 target value monitor (after calculation) *1)	-100.00 to 100.00 (%) (Range will depend on [AH-04], [AH-05], [AH-06])	
db-44	PID1 feedback value monitor (after calculation) *1)		
db-50	PID1 output monitor	-100.00 to 100.00 (%)	12-10-7
db-51	PID1 deviation monitor	-200.00 to 200.00 (%)	
db-52	PID1 deviation 1 monitor	-200.00 to 200.00 (%)	
db-53	PID1 deviation 2 monitor	-200.00 to 200.00 (%)	
db-54	PID1 deviation 3 monitor	-200.00 to 200.00 (%)	12-10-25
db-55	PID2 output monitor	-100.00 to 100.00 (%)	
db-56	PID2 deviation monitor	-200.00 to 200.00 (%)	
db-57	PID3 output monitor	-100.00 to 100.00 (%)	
db-58	PID3 deviation monitor	-200.00 to 200.00 (%)	
db-59	PID4 output monitor	-100.00 to 100.00 (%)	
db-60	PID4 deviation monitor	-200.00 to 200.00 (%)	12-10-7
db-61	Current PID P-Gain monitor	0.0 to 100.0	
db-62	Current PID I-Gain monitor	0.0 to 3600.0 (s)	
db-63	Current PID D-Gain monitor	0.00 to 100.00 (s)	
db-64	PID feedforward monitor	0.00 to 100.00 (%)	

*1) (After calculation) means that it is after calculation such as auxiliary speed or addition frequency.

■ Monitors for checking internal condition.

Code	Name	Data range	Page
dC-01	Inverter load type status	00(Very low duty)/ 01(Low duty)/ 02(Normal duty)	13-22
dC-02	Rated current monitor	0.0 to 6553.5 (A)	13-22
dC-07	Main speed input source monitor	00(Disabled)/ 01(Terminal[Ai1])/ 02(Terminal[Ai2])/ 03(Terminal[Ai3])/ 04(Terminal[Ai4])/ 05(Terminal[Ai5])/ 06(Terminal[Ai6])/ 07(Multi-Speed 0)/ 08(Auxiliary speed)/ 09(Multi-Speed 1)/ 10(Multi-Speed 2)/ 11(Multi-Speed 3)/ 12(Multi-Speed 4)/ 13(Multi-Speed 5)/ 14(Multi-Speed 6)/ 15(Multi-Speed 7)/ 16(Multi-Speed 8)/ 17(Multi-Speed 9)/ 18(Multi-Speed 10)/ 19(Multi-Speed 11)/ 20(Multi-Speed 12)/ 21(Multi-Speed 13)/ 22(Multi-Speed 14)/ 23(Multi-Speed 15)/ 24(JG)/ 25(RS485)/ 26(Option-1)/ 27(Option-2)/ 28(Option-3)/ 29(Pls-Train(In))/ 30(Pls-Train(Opt))/ 31(EzSQ)/ 32(PID)/ 33(MOP-VR)/ 34(AHD retention speed)	13-23
dC-08	Sub speed input source monitor	00(Disabled)/ 01(Terminal[Ai1])/ 02(Terminal[Ai2])/ 03(Terminal[Ai3])/ 4(Terminal[Ai4])/ 05(Terminal[Ai5])/ 06(Terminal[Ai6])/ 08(Auxiliary speed)/ 25(RS485)/ 26(Option-1)/ 27(Option-2)/ 28(Option-3)/ 29(Pls-Train(In))/ 30(Pls-Train(Opt))/ 31(EzSQ)/ 32(PID)/ 33(MOP-VR)	13-23
dC-10	RUN command input source monitor	00([FW]/[RV] terminal)/ 01(3-wire)/ 02(Keypad's RUN key)/ 03(RS485)/ 04(Option-1)/ 05(Option-2)/ 06(Option-3)	13-23
dC-15	Cooling fin temperature monitor	-20.0 to 200.0 (degrees Celsius)	13-13
dC-16	Life assessment monitor	LL to HH [L : Normal / H : Worn out] [Left side] : Cooling fan life-span [Right side] : Electrolytic capacitor on board life-span	13-16
dC-20	Accumulated number of starts monitor	1 to 65535 (count)	13-12
dC-21	Accumulated number of power-on times monitor	1 to 65535 (count)	13-12
dC-22	Accumulated RUN time monitor	0 to 1000000 (hr)	13-11
dC-24	Accumulated power-on time monitor	0 to 1000000 (hr)	13-11
dC-26	Accumulated cooling-fan run time monitor	0 to 1000000 (hr)	13-17
dC-37	Icon 2 LIM monitor	00(Other than below)/ 01(OC suppress)/ 02(OL restriction)/ 03(OV suppress)/ 04(TRQ Limit)/ 05(Freq Limit)/ 06(Min.Freq)	13-24 18-33
dC-38	Icon 2 ALT monitor	00(Other than below)/ 01(OL notice)/ 02(Motor thermal notice)/ 03(Controller thermal notice)/ 04(Motor overheating notice)	
dC-39	Icon 2 RETRY detail monitor	00(Other than below)/ 01(Waiting for retry)/ 02(Waiting for restart)	
dC-40	Icon 2 NRDY detail monitor	00(Other than below) / (When the state is other than following, Output terminal 007[IRDY]= ON.) 01(Trip occurrence)/ 02(Power supply error)/ 03(Resetting)/ 04(STO)/ 05(Standby)/ 06(Data Warning, etc)/ 07(EzSQ Sequence error)/ 08(Free run)/ 09(Forced stop)	
dC-45	IM/SM monitor	00(IM selected)/ 01(SM selected)	12-9-1
dC-50	Firmware ver. Monitor	00.00 to 99.99	4-3 21-28
dC-53	Firmware Gr. Monitor	00(Standard)	-
dE-50	Warning monitor	0 to 65535	18-38

■ Monitors and parameters for changing the current commands. *1)

Code	Name	Data range	Note	Page
FA-01	Main speed reference setting or monitor	0.00 to 590.00 (Hz)		13-3
FA-02	Sub-speed reference setting or monitor	-590.00 to 590.00 (Hz) (Monitor) 0.00 to 590.00 (Hz) (Setting)		13-3
FA-10	Acceleration time setting or monitor	0.00 to 3600.00 (s)		13-6
FA-12	Deceleration time setting or monitor	0.00 to 3600.00 (s)		13-6
FA-15	Torque reference setting or monitor *2)	-500.0 to +500.0 (%)		12-11-15
FA-16	Torque bias setting or monitor *2)	-500.0 to +500.0 (%)		12-11-12
FA-20	Position reference setting or monitor	When [AA121]≠10 or [AA123]≠03 -268435455 to +268435455 (pls)/ When [AA121]=10 and [AA123]=03 -1073741823 to +1073741823 (pls)		12-17-30
FA-30	PID1 set-point 1 setting or monitor	-100.00 to 100.00 (%) (Adjustable in [AH-04], [AH-05], [AH-06])		12-10-7
FA-32	PID1 set-point 2 setting or monitor			
FA-34	PID1 set-point 3 setting or monitor			
FA-36	PID2 set-point setting or monitor	-100.00 to 100.00 (%) (Adjustable in [AJ-04], [AJ-05], [AJ-06])		12-10-25
FA-38	PID3 set-point setting or monitor	-100.00 to 100.00 (%) (Adjustable in [AJ-24], [AJ-25], [AJ-26])		
FA-40	PID4 set-point setting or monitor	-100.00 to 100.00 (%) (Adjustable in [AJ-44], [AJ-45], [AJ-46])		

*1) The FA parameters display the value of the currently used command destination and they can be changed. However, the changeable parameter is the value which can be changed on the keypad, such as multi-speed.

Example) When the "Main speed input source selection, 1st-motor"([AA101]) is set to 07 (parameter setting), the value of [FA-01] can be changed on the parameter setting screen of the keypad. Also, the set value at this time is reflected in [Ab110] together with [FA-01].

If [FA-01] is changed when the speed command destination is "Multi-speed 1 setting", the changed value is also reflected in [Ab-11] "Multi-speed 1 setting".

When the speed command destination is analog input [Ai1], [FA-01] becomes a monitor of the input value to analog terminal [Ai1] (converted value to frequency command) and cannot be changed from the keypad.

*2) The torque control related function [FA-16] is valid when the control mode selection [AA121] / [AA221] is 08(IM-SLV), 09(IM-0Hz-SLV), or 10(IM-CLV). And [FA-15] is valid at 08 or 10.

A1.4 List of Parameter Modes

■ Parameter mode (code A).

Code	Name	Data range	Initial value	Note	Page
AA101	Main speed input source selection, 1st-motor	01(Terminal[Ai1])/ 02(Terminal[Ai2])/ 03(Terminal[Ai3])/ 04(Terminal[Ai4])/ 05(Terminal[Ai5])/ 06(Terminal[Ai6])/ 07(Parameter Setting)/ 08(RS485)/ 09(Option-1)/ 10(Option-2)/ 11(Option-3)/ 12(Pulse train input(internal))/ 13(Pulse train input(option))/ 14(Program function)/ 15(PID calc.)/ 16(MOP Keypad's VR)	07 (*FF)/ 01 (*FEF, *FUF, *FCF)		12-4-1 12-4-10
AA102	Sub speed input source selection, 1st-motor	00(Disable)/ 01(Terminal[Ai1])/ 02(Terminal[Ai2])/ 03(Terminal[Ai3])/ 04(Terminal[Ai4])/ 05(Terminal[Ai5])/ 06(Terminal[Ai6])/ 07(Parameter Setting)/ 08(RS485)/ 09(Option-1)/ 10(Option-2)/ 11(Option-3)/ 12(Pulse train input(internal))/ 13(Pulse train input(option))/ 14(Program function)/ 15(PID calc.)/ 16(MOP Keypad's VR)	00		12-4-1 12-4-10
AA104	Sub speed setting, 1st-motor	0.00 to 590.00 (Hz)	0.00		12-4-2
AA105	Speed reference calculation symbol selection, 1st-motor	00(Disable)/ 01(Addition)/ 02(Subtraction)/ 03(Multiplication)	00		12-4-10
AA106	Add frequency setting, 1st-motor	-590.00 to 590.00 (Hz)	0.00		12-4-15
AA111	RUN command input source selection, 1st-motor	00([FW]/[RV] terminal)/ 01(3-wire)/ 02(Keypad's RUN-key)/ 03(RS485)/ 04(Option-1)/ 05(Option-2)/ 06(Option-3)	02 (*FF)/ 00 (*FEF, *FUF, *FCF)		12-5-1
AA-12	RUN-key command rotation direction	00(Forward)/ 01(Reverse)	00		12-5-2
AA-13	STOP-key enable	00(Disable)/ 01(Enable)/ 02(Enable at only trip reset)	01		12-5-6
AA114	RUN direction restriction, 1st-motor	00(No restriction)/ 01(Enable only Forward rotation)/ 02(Enable only Reverse rotation)	00		12-6-2
AA115	STOP mode selection, 1st-motor	00(Deceleration stop)/ 01(Free-run stop)	00		12-15-1
AA121	Control mode selection, 1st-motor	00([V/f] Fixed torque characteristics (IM))/ 01([V/f] Reducing torque characteristics (IM))/ 02([V/f] Free V/f (IM))/ 03([V/f] Auto torque boost (IM))/ 04([V/f with encoder] Fixed torque characteristics (IM))/ 05([V/f with encoder] Reduced torque characteristics(IM))/ 06([V/f with encoder] Free V/f (IM))/ 07([V/f with encoder] Auto torque boost (IM))/ 08(Sensorless vector control (IM))/ 09(Zero-Hz-range sensorless vector control (IM)) *1) / 10(Vector control with encoder (IM)) *1) / 11(Synchronous start type sensorless vector control(SM/PMM))/ 12(IVMS start type sensorless vector control (SM/PMM)) *2)	00		12-9-1
AA123	Vector control mode selection, 1st-motor	00(Speed/Torque control mode)/ 01(Pulse train position control)/ 02(Absolute position control)/ 03(High-resolution absolute position control)	00		12-9-24 12-9-38

*1) Cannot be selected if the load type selection [Ub-03] set to 00(VLD) or 01(LD).

*2) Cannot be selected if the load type selection [Ub-03] set to 00(VLD).

Code	Name	Data range	Initial value	Note	Page
AA201	Main speed input source selection, 2nd-motor	01(Terminal[Ai1])/ 02(Terminal[Ai2])/ 03(Terminal[Ai3])/ 04(Terminal[Ai4])/ 05(Terminal[Ai5])/ 06(Terminal[Ai6])/ 07(Parameter Setting)/ 08(RS485)/ 09(Option-1)/ 10(Option-2)/ 11(Option-3)/ 12(Pulse train input(internal))/ 13(Pulse train input(option))/ 14(Program function)/ 15(PID calc.)/ 16(MOP Keypad's VR)	07 (*FF)/ 01 (*FEF, *FUF, *FCF)		12-4-1 12-4-10 12-17-1
AA202	Sub speed input source selection, 2nd-motor	00(Disable)/ 01(Terminal[Ai1])/ 02(Terminal[Ai2])/ 03(Terminal[Ai3])/ 04(Terminal[Ai4])/ 05(Terminal[Ai5])/ 06(Terminal[Ai6])/ 07(Parameter Setting)/ 08(RS485)/ 09(Option-1)/ 10(Option-2)/ 11(Option-3)/ 12(Pulse train input(internal))/ 13(Pulse train input(option))/ 14(Program function)/ 15(PID calc.)/ 16(MOP Keypad's VR)	00		12-4-1 12-4-10 12-17-1
AA204	Sub speed setting, 2nd-motor	0 to 590.00 (Hz)	0.00		12-4-2 12-17-1
AA205	Speed reference calculation symbol selection, 2nd-motor	00(Disable)/ 01(Addition)/ 02(Subtraction)/ 03(Multiplication)	00		12-4-10 12-17-1
AA206	Add frequency setting, 2nd-motor	-590.00 to 590.00 (Hz)	0.00		12-4-15 12-17-1
AA211	RUN command input source selection, 2nd-motor	00([FW]/[RV] terminal)/ 01(3-wire)/ 02(Keypad's RUN-key)/ 03(RS485)/ 04(Option-1)/ 05(Option-2)/ 06(Option-3)	02 (*FF)/ 00 (*FEF, *FUF, *FCF)		12-5-1 12-17-1
AA214	RUN-direction restriction selection, 2nd-motor	00(No restriction)/ 01(Only forward)/ 02(Only reverse)	00		12-6-2 12-17-1
AA215	STOP mode selection, 2nd-motor	00(Deceleration until stop)/ 01(Free-run stop)	00		12-15-1 12-17-1
AA221	Control mode selection 2nd-motor	00([V/f] Fixed torque characteristics (IM))/ 01([V/f] Reducing torque characteristics (IM))/ 02([V/f] Free V/f (IM))/ 03([V/f] Auto torque boost (IM))/ 04([V/f with encoder] Fixed torque characteristics (IM))/ 05([V/f with encoder] Reduced torque characteristics (IM))/ 06([V/f with encoder] Free V/f (IM))/ 07([V/f with encoder] Auto torque boost (IM))/ 08(Sensorless vector control (IM))/ 09(Zero-Hz-range sensorless vector control (IM)) *1) / 10(Vector control with encoder (IM)) *1) / 11(Synchronous start type sensorless vector control(SM/PMM))	00		12-9-1 12-17-1
AA223	Vector control mode selection, 2nd-motor	00(Speed/Torque control mode)/ 01(Pulse train position control)/ 02(Absolute position control)/ 03(High-resolution absolute position control)	00		12-9-24 12-9-38 12-17-1

*1) Cannot be selected if the load type selection [Ub-03] set to 00(VLD) or 01(LD).

Code	Name	Data range	Initial value	Note	Page
Ab-01	Frequency conversion gain	0.01 to 100.00	1.00		13-4
Ab-03	Multi-speed operation selection	00(Binary(16 speeds))/ 01(Bit(8 speeds))	00		12-4-12
Ab110	Multi-speed 0 setting, 1st-motor	0.00 to 590.00 (Hz)	0.00		12-4-2 12-4-12
Ab-11	Multi-speed 1 setting	0.00 to 590.00 (Hz)	0.00		12-4-12
Ab-12	Multi-speed 2 setting	0.00 to 590.00 (Hz)	0.00		
Ab-13	Multi-speed 3 setting	0.00 to 590.00 (Hz)	0.00		
Ab-14	Multi-speed 4 setting	0.00 to 590.00 (Hz)	0.00		
Ab-15	Multi-speed 5 setting	0.00 to 590.00 (Hz)	0.00		
Ab-16	Multi-speed 6 setting	0.00 to 590.00 (Hz)	0.00		
Ab-17	Multi-speed 7 setting	0.00 to 590.00 (Hz)	0.00		
Ab-18	Multi-speed 8 setting	0.00 to 590.00 (Hz)	0.00		
Ab-19	Multi-speed 9 setting	0.00 to 590.00 (Hz)	0.00		
Ab-20	Multi-speed 10 setting	0.00 to 590.00 (Hz)	0.00		
Ab-21	Multi-speed 11 setting	0.00 to 590.00 (Hz)	0.00		
Ab-22	Multi-speed 12 setting	0.00 to 590.00 (Hz)	0.00		
Ab-23	Multi-speed 13 setting	0.00 to 590.00 (Hz)	0.00		
Ab-24	Multi-speed 14 setting	0.00 to 590.00 (Hz)	0.00		
Ab-25	Multi-speed 15 setting	0.00 to 590.00 (Hz)	0.00		
Ab210	Multi-speed 0 setting, 2nd-motor	0.00 to 590.00 (Hz)	0.00		12-4-12

Code	Name	Data range	Initial value	Note	Page
AC-01	Acceleration/Deceleration time input source selection	00(Parameter setting)/ 01(Option-1)/ 02(Option-2)/ 03(Option-3)/ 04(Function EzSQ)	00		12-8-1
AC-02	Acceleration/Deceleration selection	00(Common setting)/ 01(Multi stage accel/ decel)	00		12-8-5
AC-03	Acceleration curve selection	00(Linear)/ 01(S-curve)/ 02(U-curve)/ 03(Reverse U-curve)/ 04(Elevator S-curve)	00		12-8-10
AC-04	Deceleration curve selection	00(Linear)/ 01(S-curve)/ 02(U-curve)/ 03(Reverse U-curve)/ 04(Elevator S-curve)	00		
AC-05	Acceleration curve constant setting	1 to 10	2		12-8-10
AC-06	Deceleration curve constant setting	1 to 10	2		
AC-08	EL-S-curve ratio @start of acceleration	0 to 100 (%)	25		
AC-09	EL-S-curve ratio @end of acceleration	0 to 100 (%)	25		
AC-10	EL-S-curve ratio @start of deceleration	0 to 100 (%)	25		
AC-11	EL-S-curve ratio @end of deceleration	0 to 100 (%)	25		
AC115	Accel/Decel change trigger, 1st-motor	00(Switching by [2CH] terminal)/ 01(Switching by setting)/ 02(Switching only when rotation is reversed)	00		12-8-3
AC116	Accel1 to Accel2 frequency transition point, 1st-motor	0.00 to 590.00 (Hz)	0.00		
AC117	Decel1 to Decel2 frequency transition point, 1st-motor	0.00 to 590.00 (Hz)	0.00		
AC120	Acceleration time setting 1, 1st-motor	0.00 to 3600.00 (s)	30.00		12-8-1
AC122	Deceleration time setting 1, 1st-motor	0.00 to 3600.00 (s)	30.00		
AC124	Acceleration time setting 2, 1st-motor	0.00 to 3600.00 (s)	15.00		12-8-3
AC126	Deceleration time setting 2, 1st-motor	0.00 to 3600.00 (s)	15.00		

Code	Name	Data range	Initial value	Note	Page
AC-30	Accel. time for Multi-speed 1	0.00 to 3600.00 (s)	0.00		12-8-5
AC-32	Decel. time for Multi-speed 1	0.00 to 3600.00 (s)	0.00		
AC-34	Accel. time for Multi-speed 2	0.00 to 3600.00 (s)	0.00		
AC-36	Decel. time for Multi-speed 2	0.00 to 3600.00 (s)	0.00		
AC-38	Accel. time for Multi-speed 3	0.00 to 3600.00 (s)	0.00		
AC-40	Decel. time for Multi-speed 3	0.00 to 3600.00 (s)	0.00		
AC-42	Accel. time for Multi-speed 4	0.00 to 3600.00 (s)	0.00		
AC-44	Decel. time for Multi-speed 4	0.00 to 3600.00 (s)	0.00		
AC-46	Accel. time for Multi-speed 5	0.00 to 3600.00 (s)	0.00		
AC-48	Decel. time for Multi-speed 5	0.00 to 3600.00 (s)	0.00		
AC-50	Accel. time for Multi-speed 6	0.00 to 3600.00 (s)	0.00		
AC-52	Decel. time for Multi-speed 6	0.00 to 3600.00 (s)	0.00		
AC-54	Accel. time for Multi-speed 7	0.00 to 3600.00 (s)	0.00		
AC-56	Decel. time for Multi-speed 7	0.00 to 3600.00 (s)	0.00		
AC-58	Accel. time for Multi-speed 8	0.00 to 3600.00 (s)	0.00		
AC-60	Decel. time for Multi-speed 8	0.00 to 3600.00 (s)	0.00		
AC-62	Accel. time for Multi-speed 9	0.00 to 3600.00 (s)	0.00		
AC-64	Decel. time for Multi-speed 9	0.00 to 3600.00 (s)	0.00		
AC-66	Accel. time for Multi-speed 10	0.00 to 3600.00 (s)	0.00		
AC-68	Decel. time for Multi-speed 10	0.00 to 3600.00 (s)	0.00		
AC-70	Accel. time for Multi-speed 11	0.00 to 3600.00 (s)	0.00		
AC-72	Decel. time for Multi-speed 11	0.00 to 3600.00 (s)	0.00		
AC-74	Accel. time for Multi-speed 12	0.00 to 3600.00 (s)	0.00		
AC-76	Decel. time for Multi-speed 12	0.00 to 3600.00 (s)	0.00		
AC-78	Accel. time for Multi-speed 13	0.00 to 3600.00 (s)	0.00		
AC-80	Decel. time for Multi-speed 13	0.00 to 3600.00 (s)	0.00		
AC-82	Accel. time for Multi-speed 14	0.00 to 3600.00 (s)	0.00		
AC-84	Decel. time for Multi-speed 14	0.00 to 3600.00 (s)	0.00		
AC-86	Accel. time for Multi-speed 15	0.00 to 3600.00 (s)	0.00		
AC-88	Decel. time for Multi-speed 15	0.00 to 3600.00 (s)	0.00		
AC215	Accel/Decel change trigger, 2nd-motor	00(Switching by [2CH] terminal)/ 01(Switching by setting)/ 02(Switching only when rotation is reversed)	00		12-8-3
AC216	Accel1 to Accel2 frequency transition point, 2nd-motor	0.00 to 590.00 (Hz)	0.00		12-17-1
AC217	Decel1 to Decel2 frequency transition point, 2nd-motor	0.00 to 590.00 (Hz)	0.00		
AC220	Acceleration time 1, 2nd-motor	0.00 to 3600.00 (s)	30.00		12-8-1
AC222	Deceleration time 1, 2nd-motor	0.00 to 3600.00 (s)	30.00		12-17-1
AC224	Acceleration time 2, 2nd-motor	0.00 to 3600.00 (s)	15.00		12-8-3
AC226	Deceleration time 2, 2nd-motor	0.00 to 3600.00 (s)	15.00		12-17-1

Code	Name	Data range	Initial value	Note	Page
Ad-01	Torque reference input source selection	01(Terminal[Ai1])/ 02(Terminal[Ai2])/ 03(Terminal[Ai3])/ 04(Terminal[Ai4])/ 05(Terminal[Ai5])/ 06(Terminal[Ai6])/ 07(Parameter Setting)/ 08(RS485)/ 09(Option-1)/ 10(Option-2)/ 11(Option-3)/ 12(Pulse train input(internal))/ 13(Pulse train input(option))/ 15(PID calc.)	07		12-11-15
Ad-02	Torque reference value setting	-500.0 to +500.0 (%) *1)	0.0		12-11-15
Ad-03	Polarity selection for torque reference	00(According to sign)/ 01(Depending on the operation direction)	00		12-11-15
Ad-04	Switching time of speed control to torque control	0 to 1000 (ms)	100		12-11-13
Ad-11	Torque bias input source selection	00(Disable)/ 01(Terminal[Ai1])/ 02(Terminal[Ai2])/ 03(Terminal[Ai3])/ 04(Terminal[Ai4])/ 05(Terminal[Ai5])/ 06(Terminal[Ai6])/ 07(Parameter Setting)/ 08(RS485)/ 09(Option-1)/ 10(Option-2)/ 11(Option-3)/ 12(Pulse train input(internal))/ 13(Pulse train input(option))/ 15(PID calc.)	00		12-11-12
Ad-12	Torque bias value setting	-500.0 to +500.0 (%) *1)	0.0		12-11-12
Ad-13	Torque bias polarity	00(According to sign)/ 01(Depending on the operation direction)	00		12-11-12
Ad-14	Enable terminal [TBS]	00(Disable)/ 01(Enable)	00		12-11-12
Ad-40	Speed limit input source selection at torque control	01(Terminal[Ai1])/ 02(Terminal[Ai2])/ 03(Terminal[Ai3])/ 04(Terminal[Ai4])/ 05(Terminal[Ai5])/ 06(Terminal[Ai6])/ 07(Parameter Setting)/ 08(RS485)/ 09(Option-1)/ 10(Option-2)/ 11(Option-3)/ 12(Pulse train input(internal))/ 13(Pulse train input(option))/	07		12-11-14
Ad-41	Speed limit at torque control (at Forward rotation)	0.00 to 590.00 (Hz)	0.00		12-11-14
Ad-42	Speed limit at torque control (at Reverse rotation)	0.00 to 590.00 (Hz)	0.00		12-11-14

*1) If this setting is excessively large (Over 200% of inverter ND rating), an overcurrent error or overload error may occur easily. When changing the set value, please fully understand the behavior of the load and motor.

Code	Name	Data range	Initial value	Note	Page
AE-01	Electronic gear setting point selection	00(Feedback side)/ 01(Reference side)	00		12-17-17
AE-02	Electronic gear ratio numerator	1 to 10000	1		
AE-03	Electronic gear ratio denominator	1 to 10000	1		
AE-04	Positioning completed range setting	0 to 10000 (pls)	5		
AE-05	Positioning completed delay time setting	0.00 to 10.00 (s)	0.00		
AE-06	Position feedforward gain setting	0.00 to 655.35	0.00		
AE-07	Position loop gain setting	0.00 to 100.00	0.50		
AE-08	Position bias setting	-2048 to 2048 (pls)	0		
AE-10	Stop position selection of home search function	00(Setting by parameter)/ 01(Option-1)/ 02(Option-2)/ 03(Option-3)	00		12-17-23
AE-11	Stop position of home search function	0 to 4095	0		
AE-12	Speed reference of home search function	0.00 to 120.00 (Hz)	0.00		
AE-13	Direction of home search function	00(Forward)/ 01(Reverse)	00		12-17-30
AE-20	Position reference 0	When [AA121]≠10 or [AA123]≠03 -268435455 to +268435455 (pls) When [AA121]=10 and [AA123]=03 -1073741823 to +1073741823 (pls)	0		
AE-22	Position reference 1		0		
AE-24	Position reference 2		0		
AE-26	Position reference 3		0		
AE-28	Position reference 4		0		
AE-30	Position reference 5		0		
AE-32	Position reference 6		0		
AE-34	Position reference 7		0		
AE-36	Position reference 8		0		
AE-38	Position reference 9		0		
AE-40	Position reference 10		0		
AE-42	Position reference 11		0		
AE-44	Position reference 12		0		
AE-46	Position reference 13		0		
AE-48	Position reference 14		0		
AE-50	Position reference 15	0			

Code	Name	Data range	Initial value	Note	Page
AE-52	Position control range setting (forward)	When [AA121]≠10 or [AA123]≠03 0 to +268435455 (pls) When [AA121]=10 and [AA123]=03 0 to +1073741823 (pls)	268435455		12-17-30
AE-54	Position control range setting (reverse)	When [AA121]≠10 or [AA123]≠03 -268435455 to 0 (pls) When [AA121]=10 and [AA123]=03 -1073741823 to 0 (pls)	-268435455		
AE-56	Position control mode selection	00(Limited)/ 01(Not limited)	00		12-17-31
AE-60	Teach-in function target selection	00 to 15 (X00 to X15)	00		
AE-61	Save current position at power off	00(Disable)/ 01(Enable)	00		
AE-62	Pre-set position data	When [AA121]≠10 or [AA123]≠03 -268435455 to +268435455 (pls) When [AA121]=10 and [AA123]=03 -1073741823 to +1073741823 (pls)	0		
AE-64	Deceleration stop distance calculation gain	50.00 to 200.00 (%)	100.00		12-17-24
AE-65	Deceleration stop distance calculation bias	0.00 to 655.35 (%)	0.00		
AE-66	Speed limit in APR control	0.00 to 100.00 (%)	1.00		
AE-67	APR start speed	0.00 to 100.00 (%)	0.20		
AE-70	Homing function selection	00(Low-speed)/ 01(High-Speed 1)/ 02(High-Speed 2)	00		12-17-32
AE-71	Direction of homing function	00(Forward)/ 01(Reverse)	00		
AE-72	Low-speed homing speed setting	0.00 to 10.00 (Hz)	0.00		
AE-73	High-speed homing speed setting	0.00 to 590.00 (Hz)	0.00		

Code	Name	Data range	Initial value	Note	Page
AF101	DC braking selection, 1st-motor	00(Disable)/ 01(Enable)/ 02(Frequency reference)	00		12-14-2 12-14-14 12-15-2
AF102	Braking type selection, 1st-motor	00(DC braking)/ 01(Speed servo-lock)/ 02(Position servo-lock)	00		12-14-2 12-14-14 12-15-2
AF103	DC braking frequency, 1st-motor	0.00 to 590.00 (Hz)	0.50		12-14-2 12-15-2
AF104	DC braking delay time, 1st-motor	0.00 to 5.00 (s)	0.00		12-15-2 12-15-6
AF105	DC braking force setting, 1st-motor	0 to 100 (%) (Might be internally limited)	30		12-15-2 12-17-9
AF106	DC braking active time at stop, 1st-motor	0.00 to 60.00 (s)	0.00		12-15-2
AF107	DC braking operation method selection, 1st-motor	00(Edge)/ 01(Level)	01		12-15-2 12-15-6
AF108	DC braking force at start, 1st-motor	0 to 100 (%) (Might be internally limited)	30		12-14-2 12-17-9
AF109	DC braking active time at start, 1st-motor	0.00 to 60.00 (s)	0.00		12-14-2 12-14-14
AF120	Contactor control enable, 1st-motor	00(Disable)/ 01(Enable: primary side)/ 02(Enable: secondary side)	00		12-17-10
AF121	Run delay time, 1st-motor	0.00 to 2.00 (s)	0.20		
AF122	Contactor off delay time, 1st-motor	0.00 to 2.00 (s)	0.10		
AF123	Contactor response check time, 1st-motor	0.00 to 5.00 (s)	0.10		
AF130	Brake control enable, 1st-motor	00(Disable)/ 01(Brake control 1: Common)/ 02(Brake control 1: Separate)/ 03(Brake control 2)	00		12-17-7 12-17-9
AF131	Brake release wait time, 1st-motor (Forward)	0.00 to 5.00 (s)	0.00		12-17-7
AF132	Brake wait time for accel., 1st-motor (Forward)	0.00 to 5.00 (s)	0.00		
AF133	Brake wait time for stopping, 1st-motor (Forward)	0.00 to 5.00 (s)	0.00		
AF134	Brake confirmation signal wait time, 1st-motor (Forward)	0.00 to 5.00 (s)	0.00		
AF135	Brake release frequency setting, 1st-motor (Forward)	0.00 to 590.00 (Hz)	0.00		
AF136	Brake release current setting, 1st-motor (Forward)	(0.0 to 2.0) × Inverter rated current (A)	1.0 × Inverter rated current		
AF137	Braking frequency, 1st-motor (Forward)	0.00 to 590.00 (Hz)	0.00		
AF138	Brake release wait time, 1st-motor (Reverse)	0.00 to 5.00 (s)	0.00		
AF139	Brake wait time for accel., 1st-motor (Reverse)	0.00 to 5.00 (s)	0.00		
AF140	Brake wait time for stopping, 1st-motor (Reverse)	0.00 to 5.00 (s)	0.00		
AF141	Brake confirmation signal wait time, 1st-motor (Reverse)	0.00 to 5.00 (s)	0.00		
AF142	Brake release frequency setting, 1st-motor (Reverse)	0.00 to 590.00 (Hz)	0.00		
AF143	Brake release current setting, 1st-motor (Reverse)	(0.0 to 2.0) × Inverter rated current (A)	1.0 × Inverter rated current		
AF144	Braking frequency, 1st-motor (Reverse)	0.00 to 590.00 (Hz)	0.00		
AF150	Brake open delay time, 1st-motor	0.00 to 2.00 (s)	0.20		12-17-9
AF151	Brake close delay time, 1st-motor	0.00 to 2.00 (s)	0.20		
AF152	Brake response check time, 1st-motor	0.00 to 5.00 (s)	0.10		
AF153	Servo lock/ DC injection time at start, 1st-motor	0.00 to 10.00 (s)	0.60		
AF154	Servo lock/ DC injection time at stop, 1st-motor	0.00 to 10.00 (s)	0.60		

Code	Name	Data range	Initial value	Note	Page
AF201	DC braking selection, 2nd-motor	00(Disable)/ 01(Enable)/ 02(Frequency reference)	00		
AF202	Braking type selection, 2nd-motor	00(DC braking)/ 01(Speed servo-lock)/ 02(Position servo-lock)	00		
AF203	DC braking frequency, 2nd-motor	0.00 to 590.00 (Hz)	0.50		
AF204	DC braking delay time, 2nd-motor	0.00 to 5.00 (s)	0.00		
AF205	DC braking force setting, 2nd-motor	0 to 100 (%) (Might be internally limited)	30		
AF206	DC braking active time at stop, 2nd-motor	0.00 to 60.00 (s)	0.00		
AF207	DC braking operation method selection, 2nd-motor	00(Edge)/ 01(Level)	01		
AF208	DC braking force at start, 2nd-motor	0 to 100 (%) (Might be internally limited)	30		
AF209	DC braking active time at start, 2nd-motor	0.00 to 60.00 (s)	0.00		
AF220	Contactoer control enable, 2nd-motor	00(Disable)/ 01(Enable: primary side)/ 02(Enable: secondary side)	00		
AF221	Run delay time, 2nd-motor	0.00 to 2.00 (s)	0.20		
AF222	Contactoer off delay time, 2nd-motor	0.00 to 2.00 (s)	0.10		
AF223	Contactoer response check time, 2nd-motor	0.00 to 5.00 (s)	0.10		
AF230	Brake control enable, 2nd-motor	00(Disable)/ 01(Brake control 1: Common)/ 02(Brake control 1: Separate)/ 03(Brake control 2)	00		
AF231	Brake release wait time, 2nd-motor (Forward)	0.00 to 5.00 (s)	0.00		For details, refer to AF101 to AF154.
AF232	Brake wait time for accel., 2nd-motor (Forward)	0.00 to 5.00 (s)	0.00		
AF233	Brake wait time for stopping, 2nd-motor (Forward)	0.00 to 5.00 (s)	0.00		For the 2nd-motor control, see 12-17-1.
AF234	Brake confirmation signal wait time, 2nd-motor (Forward)	0.00 to 5.00 (s)	0.00		
AF235	Brake release frequency setting, 2nd-motor (Forward)	0.00 to 590.00 (Hz)	0.00		
AF236	Brake release current setting, 2nd-motor (Forward)	(0.0 to 2.0) × Inverter rated current (A)	1.0 × Inverter rated current		
AF237	Braking frequency, 2nd-motor (Forward)	0.00 to 590.00 (Hz)	0.00		
AF238	Brake release wait time, 2nd-motor (Reverse)	0.00 to 5.00 (s)	0.00		
AF239	Brake wait time for accel., 2nd-motor (Reverse)	0.00 to 5.00 (s)	0.00		
AF240	Brake wait time for stopping, 2nd-motor (Reverse)	0.00 to 5.00 (s)	0.00		
AF241	Brake confirmation signal wait time, 2nd-motor (Reverse)	0.00 to 5.00 (s)	0.00		
AF242	Brake release frequency setting, 2nd-motor (Reverse)	0.00 to 590.00 (Hz)	0.00		
AF243	Brake release current setting, 2nd-motor (Reverse)	(0.0 to 2.0) × Inverter rated current (A)	1.0 × Inverter rated current		
AF244	Braking frequency, 2nd-motor (Reverse)	0.00 to 590.00 (Hz)	0.00		
AF250	Brake open delay time, 2nd-motor	0.00 to 2.00 (s)	0.20		
AF251	Brake close delay time, 2nd-motor	0.00 to 2.00 (s)	0.20		
AF252	Brake response check time, 2nd-motor	0.00 to 5.00 (s)	0.10		
AF253	Servo lock/ DC injection time at start, 2nd-motor	0.00 to 10.00 (s)	0.60		
AF254	Servo lock/ DC injection time at stop, 2nd-motor	0.00 to 10.00 (s)	0.60		

Code	Name	Data range	Initial value	Note	Page
AG101	Jump frequency 1, 1st-motor	0.00 to 590.00 (Hz)	0.00		12-16-10
AG102	Jump frequency width 1, 1st-motor	0.00 to 10.00 (Hz)	0.00		
AG103	Jump frequency 2, 1st-motor	0.00 to 590.00 (Hz)	0.00		
AG104	Jump frequency width 2, 1st-motor	0.00 to 10.00 (Hz)	0.00		
AG105	Jump frequency 3, 1st-motor	0.00 to 590.00 (Hz)	0.00		
AG106	Jump frequency width 3, 1st-motor	0.00 to 10.00 (Hz)	0.00		
AG110	Acceleration stop frequency setting, 1st-motor	0.00 to 590.00 (Hz)	0.00		12-8-8
AG111	Acceleration stop time setting, 1st-motor	0.0 to 60.0 (s)	0.0		
AG112	Deceleration stop frequency setting, 1st-motor	0.00 to 590.00 (Hz)	0.00		
AG113	Deceleration stop time setting, 1st-motor	0.0 to 60.0 (s)	0.0		
AG-20	Jogging frequency	0.00 to 10.00 (Hz)	6.00		12-17-4
AG-21	Jogging stop mode selection	00(Free run at Jogging stop (Disable at run))/ 01(Deceleration stop at Jogging stop (Disable at run))/ 02(DC braking at Jogging stop (Disable at run))/ 03(Free run at Jogging stop (Enable at run))/ 04(Deceleration stop at Jogging stop (Enable at run))/ 05(DC braking at Jogging stop (Enable at run))	00		12-17-4
AG201	Jump frequency 1, 2nd-motor	0.00 to 590.00 (Hz)	0.00		For details, refer to AG101 to AG113. For the 2nd-motor control, see 12-17-1.
AG202	Jump frequency width 1, 2nd-motor	0.00 to 10.00 (Hz)	0.00		
AG203	Jump frequency 2, 2nd-motor	0.00 to 590.00 (Hz)	0.00		
AG204	Jump frequency width 2, 2nd-motor	0.00 to 10.00 (Hz)	0.00		
AG205	Jump frequency 3, 2nd-motor	0.00 to 590.00 (Hz)	0.00		
AG206	Jump frequency width 3, 2nd-motor	0.00 to 10.00 (Hz)	0.00		
AG210	Acceleration stop frequency setting, 2nd-motor	0.00 to 590.00 (Hz)	0.00		
AG211	Acceleration stop time setting, 2nd-motor	0.0 to 60.0 (s)	0.0		
AG212	Deceleration stop frequency setting, 2nd-motor	0.00 to 590.00 (Hz)	0.00		
AG213	Deceleration stop time setting, 2nd-motor	0.0 to 60.0 (s)	0.0		

Code	Name	Data range	Initial value	Note	Page
AH-01	PID1 enable	00(Disable)/ 01(Enable)/ 02(Enable (with inverted output))	00		12-10-5
AH-02	PID1 deviation inversion	00(Disable)/ 01(Enable)	00		12-10-5
AH-03	Unit selection for PID1	See <Unit options> at the end of Appendix-1	01		12-10-31
AH-04	PID1 adjustment (0%)	-10000 to 10000	0		
AH-05	PID1 adjustment (100%)	-10000 to 10000	10000		
AH-06	PID1 Adjustment (decimal point position)	0 to 4	2		
AH-07	PID1 set-point 1 input source selection	00(Not used)/ 01(Terminal[Ai1])/ 02(Terminal[Ai2])/ 03(Terminal[Ai3])/ 04(Terminal[Ai4])/ 05(Terminal[Ai5])/ 06(Terminal[Ai6])/ 07(Parameter setting)/ 08(RS485)/ 09(Option-1)/ 10(Option-2)/ 11(Option-3)/ 12(Pulse train input(internal))/ 13(Pulse train input(option))	07		12-10-5
AH-10	PID1 set-point-1 setting	-100.00 to 100.00 (%) *1)	0.00		12-10-10
AH-12	PID1 multistage set-point 1	-100.00 to 100.00 (%) *1)	0.00		
AH-14	PID1 multistage set-point 2	-100.00 to 100.00 (%) *1)	0.00		
AH-16	PID1 multistage set-point 3	-100.00 to 100.00 (%) *1)	0.00		
AH-18	PID1 multistage set-point 4	-100.00 to 100.00 (%) *1)	0.00		
AH-20	PID1 multistage set-point 5	-100.00 to 100.00 (%) *1)	0.00		
AH-22	PID1 multistage set-point 6	-100.00 to 100.00 (%) *1)	0.00		
AH-24	PID1 multistage set-point 7	-100.00 to 100.00 (%) *1)	0.00		
AH-26	PID1 multistage set-point 8	-100.00 to 100.00 (%) *1)	0.00		
AH-28	PID1 multistage set-point 9	-100.00 to 100.00 (%) *1)	0.00		
AH-30	PID1 multistage set-point 10	-100.00 to 100.00 (%) *1)	0.00		
AH-32	PID1 multistage set-point 11	-100.00 to 100.00 (%) *1)	0.00		
AH-34	PID1 multistage set-point 12	-100.00 to 100.00 (%) *1)	0.00		
AH-36	PID1 multistage set-point 13	-100.00 to 100.00 (%) *1)	0.00		
AH-38	PID1 multistage set-point 14	-100.00 to 100.00 (%) *1)	0.00		
AH-40	PID1 multistage set-point 15	-100.00 to 100.00 (%) *1)	0.00		

*1) The data range will be changed depend on [AH-04], [AH-05], [AH-06].

Code	Name	Data range	Initial value	Note	Page
AH-42	PID1 set-point 2 input source selection	00(Not used)/ 01(Terminal[Ai1])/ 02(Terminal[Ai2])/ 03(Terminal[Ai3])/ 04(Terminal[Ai4])/ 05(Terminal[Ai5])/ 06(Terminal[Ai6])/ 07(Parameter setting)/ 08(RS485)/ 09(Option-1)/ 10(Option-2)/ 11(Option-3)/ 12(Pulse train input(internal))/ 13(Pulse train input(option))	00		12-10-10
AH-44	PID1 set-point 2 setting	-100.00 to 100.00 (%) *1)	0.00		
AH-46	PID1 set-point 3 input source selection	00(Not used)/ 01(Terminal[Ai1])/ 02(Terminal[Ai2])/ 03(Terminal[Ai3])/ 04(Terminal[Ai4])/ 05(Terminal[Ai5])/ 06(Terminal[Ai6])/ 07(Parameter setting)/ 08(RS485)/ 09(Option-1)/ 10(Option-2)/ 11(Option-3)/ 12(Pulse train input(internal))/ 13(Pulse train input(option))	00		
AH-48	PID1 set-point 3 setting	-100.00 to 100.00 (%) *1)	0.00		
AH-50	PID1 set-point calculation symbol selection	01(Addition)/ 02(Subtraction)/ 03(Multiplication)/ 04(Division)/ 05(Minimum deviation)/ 06(Maximum deviation)	01		
AH-51	PID1 feedback 1 input source selection	00(Not used)/ 01(Terminal[Ai1])/ 02(Terminal[Ai2])/ 03(Terminal[Ai3])/ 04(Terminal[Ai4])/ 05(Terminal[Ai5])/ 06(Terminal[Ai6])/ 08(RS485)/ 09(Option-1)/ 10(Option-2)/ 11(Option-3)/ 12(Pulse train input(internal))/ 13(Pulse train input(option))	01		12-10-6
AH-52	PID1 feedback 2 input source selection		00		
AH-53	PID1 feedback 3 input source selection		00		
AH-54	PID1 feedback calculation symbol selection	01(Addition FB1+FB2)/ 02(Subtraction FB1-FB2)/ 03(Multiplication FB1×FB2)/ 04(Division FB1/FB2)/ 05(Square Root of FB1)/ 06(Square Root of FB2)/ 07(Square Root FB1-FB2)/ 08(Average of the three inputs)/ 09(Minimum of the three inputs)/ 10(Maximum of the three inputs)	01		
AH-60	PID1 gain change method selection	00(Using gain-1 only)/ 01([PRO] terminal)	00		
AH-61	PID1 proportional gain 1	0.0 to 100.0	1.0		
AH-62	PID1 integral time constant 1	0.0 to 3600.0 (s)	1.0		
AH-63	PID1 derivative gain 1	0.00 to 100.00 (s)	0.00		
AH-64	PID1 proportional gain 2	0.0 to 100.0	0.0		
AH-65	PID1 integral time constant 2	0.0 to 3600.0 (s)	0.0		
AH-66	PID1 derivative gain 2	0.00 to 100.00 (s)	0.00		
AH-67	PID1 gain change time	0 to 10000 (ms)	100		

*1) The data range will be changed depend on [AH-04], [AH-05], [AH-06].

Code	Name	Data range	Initial value	Note	Page
AH-70	PID1 feed-forward input source selection	00(Not used)/ 01(Terminal[Ai1])/ 02(Terminal[Ai2])/ 03(Terminal[Ai3])/ 04(Terminal[Ai4])/ 05(Terminal[Ai5])/ 06(Terminal[Ai6])	00		12-10-6
AH-71	PID1 output range	0.00 to 100.00 (%)	0.00		12-10-13
AH-72	PID1 over deviation level	0.00 to 100.00 (%)	3.00		12-10-28
AH-73	Turn-off level for the PID1 feedback compare signal	0.00 to 100.00 (%)	100.00		12-10-29
AH-74	Turn-on level for the PID1 feedback compare signal	0.00 to 100.00 (%)	0.00		12-10-29
AH-75	PID soft start function enable	00(Disable)/ 01(Enable)	00		12-10-15
AH-76	PID soft start target level	0.00 to 100.00 (%)	100.00		
AH-78	Acceleration time setting for PID soft start function	0.00 to 3600.00 (s)	30.00		
AH-80	PID soft start time	0.00 to 600.00 (s) *1)	0.00		
AH-81	PID soft start error detection enable	00(Disable)/ 01(Enable: Error)/ 02(Enable: Warning)	00		12-10-16
AH-82	PID soft start error detection level	0.00 to 100.00 (%)	0.00		12-10-17
AH-85	PID sleep trigger selection	00(Disable)/ 01(Low output)/ 02([SLEP] terminal)	00		
AH-86	PID sleep start level	0.00 to 590.00 (Hz)	0.00		
AH-87	PID sleep active time	0.00 to 100.00 (s)	0.00		
AH-88	Enable set-point boost before PID sleep	00(Disable)/ 01(Enable)	00		
AH-89	Set-point boost time before PID sleep	0.00 to 100.00 (s)	0.00		
AH-90	Set-point boost value before PID sleep	0.00 to 100.00 (%)	0.00		
AH-91	Minimum RUN time before PID sleep	0.00 to 100.00 (s)	0.00		
AH-92	Minimum active time of PID sleep	0.00 to 100.00 (s)	0.00		
AH-93	PID wake trigger selection	01(Deviation)/ 02(Low feedback)/ 03([WAKE] terminal)	01		
AH-94	PID wake start level	0.00 to 100.00 (%)	0.00		
AH-95	PID wake start time	0.00 to 100.00 (s)	0.00		
AH-96	PID wake start deviation value	0.00 to 100.00 (%)	0.00		

*1) The data range Ver2.01 or older is 0.00 to 100.0(s).

Code	Name	Data range	Initial value	Note	Page
AJ-01	PID2 enable	00(Disable)/ 01(Enable)/ 02(Enable (with inverted output))	00		12-10-23 12-10-27
AJ-02	PID2 deviation inversion	00(Disable)/ 01(Enable)	00		12-10-23
AJ-03	PID2 unit selection	See <Unit options> at the end of Appendix-1	01		12-10-31
AJ-04	PID2 scale adjustment (0%)	-10000 to 10000	0		
AJ-05	PID2 scale adjustment (100%)	-10000 to 10000	10000		
AJ-06	PID2 scale adjustment (decimal point position)	0 to 4	2		
AJ-07	PID2 set-point input source selection	00(Not used)/ 01(Terminal[Ai1])/ 02(Terminal[Ai2])/ 03(Terminal[Ai3])/ 04(Terminal[Ai4])/ 05(Terminal[Ai5])/ 06(Terminal[Ai6])/ 07(Parameter setting)/ 08(RS485)/ 09(Option-1)/ 10(Option-2)/ 11(Option- 3)/ 12(Pulse train input(internal))/ 13(Pulse train input(option))/ 15(PID1 output)	07		12-10-23
AJ-10	PID2 set-point setting	-100.00 to 100.00 (%) *1)	0.00		
AJ-12	PID2 feedback input source selection	00(Not used)/ 01(Terminal[Ai1])/ 02(Terminal[Ai2])/ 03(Terminal[Ai3])/ 04(Terminal[Ai4])/ 05(Terminal[Ai5])/ 06(Terminal[Ai6])/ 08(RS485)/ 09(Option-1)/ 10(Option-2)/ 11(Option- 3)/ 12(Pulse train input(internal))/ 13(Pulse train input(option))	02		
AJ-13	PID2 proportional gain	0.0 to 100.0	1.0		
AJ-14	PID2 integral time constant	0.0 to 3600.0 (s)	1.0		
AJ-15	PID2 derivative gain	0.00 to 100.00 (s)	0.00		
AJ-16	PID2 output range	0.00 to 100.00 (%)	0.00		
AJ-17	PID2 over deviation level	0.00 to 100.00 (%)	3.00		12-10-27 12-10-28
AJ-18	Turn-off level for the PID2 feedback compare signal	0.00 to 100.00 (%)	100.00		12-10-29
AJ-19	Turn-on level for the PID2 feedback compare signal	0.00 to 100.00 (%)	0.00		12-10-29

*1) The data range will be changed depend on [AJ-04] [AJ-05] [AJ-06].

Code	Name	Data range	Initial value	Note	Page
AJ-21	PID3 enable	00(Disable)/ 01(Enable)/ 02(Enable (with inverted output))	00		12-10-23 12-10-27
AJ-22	PID3 deviation inversion	00(Disable)/ 01(Enable)	00		12-10-23
AJ-23	PID3 unit selection	See <Unit options> at the end of Appendix-1	01		12-10-31
AJ-24	PID3 scale adjustment (0%)	-10000 to 10000	0		
AJ-25	PID3 scale adjustment (100%)	-10000 to 10000	10000		
AJ-26	PID3 scale adjustment (decimal point position)	0 to 4	2		
AJ-27	PID3 set-point input source selection	00(Not used)/ 01(Terminal[Ai1])/ 02(Terminal[Ai2])/ 03(Terminal[Ai3])/ 04(Terminal[Ai4])/ 05(Terminal[Ai5])/ 06(Terminal[Ai6])/ 07(Parameter setting)/ 08(RS485)/ 09(Option-1)/10(Option-2)/11(Option-3)/ 12(Pulse train input(internal))/ 13(Pulse train input(option))	07		12-10-23
AJ-30	PID3 set-point setting	-100.00 to 100.00 (%) *1)	0.00		
AJ-32	PID3 feedback input source selection	00(Not used)/ 01(Terminal[Ai1])/ 02(Terminal[Ai2])/ 03(Terminal[Ai3])/ 04(Terminal[Ai4])/ 05(Terminal[Ai5])/ 06(Terminal[Ai6])/ 08(RS485)/ 09(Option-1)/ 10(Option-2)/ 11(Option-3)/ 12(Pulse train input(internal))/ 13(Pulse train input(option))	01		
AJ-33	PID3 proportional gain	0.0 to 100.0	1.0		
AJ-34	PID3 integral time constant	0.0 to 3600.0 (s)	1.0		
AJ-35	PID3 derivative gain	0.00 to 100.00 (s)	0.00		
AJ-36	PID3 output range	0.00 to 100.00 (%)	0.00		12-10-27
AJ-37	PID3 over deviation level	0.00 to 100.00 (%)	3.00		12-10-28
AJ-38	Turn-off level for the PID3 feedback compare signal	0.00 to 100.00 (%)	100.00		12-10-29
AJ-39	Turn-on level for the PID3 feedback compare signal	0.00 to 100.00 (%)	0.00		12-10-29

*1) The data range will be changed depend on [AJ-24] [AJ-25] [AJ-26].

Code	Name	Data range	Initial value	Note	Page
AJ-41	PID4 enable	00(Disable)/ 01(Enable)/ 02(Enable (with inverted output))	00		12-10-24 12-10-27
AJ-42	PID4 deviation inversion	00(Disable)/ 01(Enable)	00		12-10-24
AJ-43	PID4 unit selection	See <Unit options> at the end of Appendix-1	01		12-10-31
AJ-44	PID4 scale adjustment (0%)	-10000 to 10000	0		
AJ-45	PID4 scale adjustment (100%)	-10000 to 10000	10000		
AJ-46	PID4 scale adjustment (decimal point position)	0 to 4	2		
AJ-47	PID4 set-point input source selection	00(Not used)/ 01(Terminal[Ai1])/ 02(Terminal[Ai2])/ 03(Terminal[Ai3])/ 04(Terminal[Ai4])/ 05(Terminal[Ai5])/ 06(Terminal[Ai6])/ 07(Parameter setting)/ 08(RS485)/ 09(Option-1)/10(Option-2)/11(Option-3)/ 12(Pulse train input(internal))/ 13(Pulse train input(option))	07		12-10-24
AJ-50	PID4 set-point setting	-100.00 to 100.00 (%) *1)	0.00		
AJ-52	PID4 feedback input source selection	00(Not used)/ 01(Terminal[Ai1])/ 02(Terminal[Ai2])/ 03(Terminal[Ai3])/ 04(Terminal[Ai4])/ 05(Terminal[Ai5])/ 06(Terminal[Ai6])/ 08(RS485)/ 09(Option-1)/10(Option-2)/11(Option-3)/ 12(Pulse train input(internal))/ 13(Pulse train input(option))	01		
AJ-53	PID4 proportional gain	0.0 to 100.0	1.0		
AJ-54	PID4 integral time constant	0.0 to 3600.0 (s)	1.0		
AJ-55	PID4 derivative gain	0.00 to 100.00 (s)	0.00		
AJ-56	PID4 output range	0.00 to 100.00 (%)	0.00		
AJ-57	PID4 over deviation level	0.00 to 100.00 (%)	3.00		12-10-27
AJ-58	Turn-off level for the PID4 feedback compare signal	0.00 to 100.00 (%)	100.00		12-10-28
AJ-59	Turn-on level for the PID4 feedback compare signal	0.00 to 100.00 (%)	0.00		12-10-29

*1) The data range will be changed depend on [AJ-44] [AJ-45] [AJ-46]).

■ Parameter mode (code B).

Code	Name	Data range	Initial value	Note	Page
bA101	Upper frequency limit source selection, 1st-motor	00(Disable)/ 01(Terminal[Ai1])/ 02(Terminal[Ai2])/ 03(Terminal[Ai3])/ 04(Terminal[Ai4])/ 05(Terminal[Ai5])/ 06(Terminal[Ai6])/ 07(Parameter Setting)/ 08(RS485)/ 09(Option-1)/ 10(Option-2)/ 11(Option-3)/ 12(Pulse train input(internal))/ 13(Pulse train input(option))	00		12-6-1
bA102	Upper frequency limit, 1st-motor	0.00 to 590.00 (Hz)	0.00		
bA103	Lower frequency limit , 1st-motor	0.00 to 590.00 (Hz)	0.00		
bA110	Torque limit selection, 1st-motor	00(Disable)/ 01(Terminal[Ai1])/ 02(Terminal[Ai2])/03(Terminal[Ai3])/ 04(Terminal[Ai4])/ 05(Terminal[Ai5])/ 06(Terminal[Ai6])/ 07(Parameter Setting)/ 08(RS485)/ 09(Option-1)/ 10(Option-2)/ 11(Option-3)	07		12-11-8
bA111	Torque limiting parameters mode selection, 1st-motor	00(4 quadrants)/ 01(Switched by [TRQ1][TRQ2] terminals)	00		
bA112	Torque limit 1 (Forward drive), 1st-motor	0.0 to 500.0 (%) *1)	150.0		
bA113	Torque limit 2 (Reverse regenerative), 1st-motor	0.0 to 500.0 (%) *1)	150.0		
bA114	Torque limit 3 (Reverse drive), 1st-motor	0.0 to 500.0 (%) *1)	150.0		
bA115	Torque limit 4 (Forward regenerative), 1st-motor	0.0 to 500.0 (%) *1)	150.0		
bA116	Torque limit LADSTOP selection, 1st-motor	00(Disable)/ 01(Enable)	00		
bA120	Overcurrent suppression enable, 1st-motor	00(Disable)/ 01(Enable)	01		12-13-3
bA121	Overcurrent suppression level, 1st-motor	(0.0 to 2.0) × Inverter rated current (A)	*2)		12-13-3
bA122	Overload restriction 1 mode selection, 1st-motor	00(Disable)/ 01(Enable during accel. and constant speed)/ 02(Constant speed only)/ 03(Enable during accel. and constant speed(accel. during regeneration))	01		12-13-2
bA123	Overload restriction 1 active level, 1st-motor	(0.2 to 2.0) × Inverter rated current (A)	*3)		
bA124	Overload restriction 1 action time, 1st-motor	0.10 to 3600.00 (s)	1.00		
bA126	Overload restriction 2 mode selection, 1st-motor	00(Disable)/ 01(Enable during accel. and constant speed)/ 02(Constant speed only)/ 03(Enable during accel. and constant speed(accel. during regeneration))	01		
bA127	Overload restriction 2 active level, 1st-motor	(0.2 to 2.0) × Inverter rated current (A)	*3)		
bA128	Overload restriction 2 action time, 1st-motor	0.10 to 3600.00 (s)	1.00		

*1) If this setting is excessively large (Over 200% of inverter ND rating), an overcurrent error or overload error may occur easily. When changing the set value, please fully understand the behavior of the load and motor.

*2) 1.8 × Inverter rated current (A).

*3) 1.5 × Inverter rated current (A).

Code	Name	Data range	Initial value	Note	Page
bA-30	Instantaneous power failure non-stop function, mode selection	00(Disable)/ 01(Deceleration-stop)/ 02(Voltage controlled decel-stop(without recovery))/ 03(Voltage controlled decel-stop (with recovery))	00		12-13-17
bA-31	Instantaneous power failure non-stop function, start voltage level	0.0 to 410.0 (VDC) (200V class) 0.0 to 820.0 (VDC) (400V class)	220.0 440.0		
bA-32	Instantaneous power failure non-stop function, target voltage level	0.0 to 410.0 (VDC) (200V class) 0.0 to 820.0 (VDC) (400V class)	360.0 720.0		
bA-34	Instantaneous power failure non-stop function, deceleration time	0.01 to 3600.00 (s)	1.00		
bA-36	Instantaneous power failure non-stop function, start frequency decrement	0.00 to 10.00 (Hz)	0.00		
bA-37	Instantaneous power failure non-stop function, DC bus voltage control P gain	0.00 to 5.00	0.20		
bA-38	Instantaneous power failure non-stop function, DC bus voltage control I gain	0.00 to 150.00 (s)	1.00		
bA140	Overvoltage suppression enable setting, 1st-motor	00(Disable)/ 01(Constant DC bus voltage control(deceleration stop))/ 02(Enable acceleration)/ 03(Enable acceleration (at constant speed and deceleration))	00		
bA141	Overvoltage suppression active level, 1st-motor	330.0 to 400.0 (VDC) (200V class) 660.0 to 800.0 (VDC) (400V class)	380.0 760.0		
bA142	Overvoltage suppression active time, 1st-motor	0.00 to 3600.00 (s)	1.00		
bA144	Constant DC bus voltage control P gain, 1st-motor	0.00 to 5.00	0.20		
bA145	Constant DC bus voltage control I gain, 1st-motor	0.00 to 150.00 (s)	1.00		
bA146	Over-magnetization function selection, 1st-motor	00(Disable)/ 01(Always enable)/ 02(At deceleration only)/ 03(Operation at setting level)/ 04(Operation at setting level at deceleration only)	02		12-13-6
bA147	Over-magnetization function output filter time constant, 1st_motor	0.00 to 1.00 (s)	0.30		
bA148	Over-magnetization function voltage gain, 1st-motor	50 to 400 (%)	100		
bA149	Over-magnetization function level setting, 1st-motor	330.0 to 400.0 (VDC) (200V class) 660.0 to 800.0 (VDC) (400V class)	360.0 720.0		
bA-60	Dynamic brake use ratio	0.0 to 10.0×([bA-63] / (Inverter minimum resistor))^2 (%)	10.0		12-13-8
bA-61	Dynamic brake activation selection	00(Disable)/ 01(Only while running)/ 02(Enable during stop)	00		
bA-62	Dynamic brake activation level	330.0 to 400.0 (VDC) (200V class) 660.0 to 800.0 (VDC) (400V class)	360.0 720.0		
bA-63	Dynamic brake resistor value	Minimum resistance to 600 (Ω)	Minimum resistance *1)		
bA-70	Cooling fan control method selection	00(Always ON)/ 01(While inverter operates)/ 02(Depends on temperature)	00		12-18-1
bA-71	Clear accumulated cooling fan run time monitor	00(Disable)/ 01(Clear)	00		13-17

*1) The minimum resistance varies depending on inverter models.

Code	Name	Data range	Initial value	Note	Page
bA201	Upper frequency limit source selection, 2nd-motor	00(Disable)/ 01(Terminal[Ai1])/ 02(Terminal[Ai2])/ 03(Terminal[Ai3])/ 04(Terminal[Ai4])/ 05(Terminal[Ai5])/ 06(Terminal[Ai6])/ 07(Parameter Setting)/ 08(RS485)/ 09(Option-1)/ 10(Option-2)/ 11(Option-3)/ 12(Pulse train input(internal))/ 13(Pulse train input(option))	00		For details, refer to bA101 to bA116. For the 2nd-motor control, see 12-17-1.
bA202	Upper Frequency limit, 2nd-motor	0.00 to 590.00 (Hz)	0.00		
bA203	Lower Frequency limit , 2nd-motor	0.00 to 590.00 (Hz)	0.00		
bA210	Torque limit selection, 2nd-motor	00(Disable)/ 01(Terminal[Ai1])/ 02(Terminal[Ai2])/ 03(Terminal[Ai3])/ 04(Terminal[Ai4])/ 05(Terminal[Ai5])/ 06(Terminal[Ai6])/ 07(Parameter Setting)/ 08(RS485)/ 09(Option-1)/ 10(Option-2)/ 11(Option-3)	07		
bA211	Torque limiting parameters mode selection, 2nd-motor	00(4 quadrants)/ 01(Switched by [TRQ1][TRQ2] terminals)	00		
bA212	Torque limit 1 (Forward drive), 2nd-motor	0.0 to 500.0 (%) *1)	150.0		
bA213	Torque limit 2 (Reverse regenerative), 2nd-motor	0.0 to 500.0 (%) *1)	150.0		
bA214	Torque limit 3 (Reverse drive), 2nd-motor	0.0 to 500.0 (%) *1)	150.0		
bA215	Torque limit 4 (Forward regenerative), 2nd-motor	0.0 to 500.0 (%) *1)	150.0		
bA216	Torque limit LADSTOP selection, 2nd-motor	00(Disable)/ 01(Enable)	00		

*1) If this setting is excessively large (Over 200% of inverter ND rating), an overcurrent error or overload error may occur easily. When changing the set value, please fully understand the behavior of the load and motor.

Code	Name	Data range	Initial value	Note	Page
bA220	Overcurrent suppression enable, 2nd-motor	00(Disable)/ 01(Enable)	01		
bA221	Overcurrent suppression level, 2nd-motor	(0.0 to 2.0) × Inverter rated current (A)	*1)		
bA222	Overload restriction 1 mode selection, 2nd-motor	00(Disable)/ 01(Enable during accel. and constant speed)/ 02(Constant speed only)/ 03(Enable during accel. and constant speed(accel. during regeneration))	01		
bA223	Overload restriction 1 active level, 2nd-motor	(0.2 to 2.0) × Inverter rated current (A)	*2)		
bA224	Overload restriction 1 action time, 2nd-motor	0.10 to 3600.00 (s)	1.00		
bA226	Overload restriction 2 mode selection, 2nd-motor	00(Disable)/ 01(Enable during accel. and constant speed)/ 02(Constant speed only)/ 03(Enable during accel. and constant speed(accel. during regeneration))	01		
bA227	Overload restriction 2 active level, 2nd-motor	(0.2 to 2.0) × Inverter rated current (A)	*2)		
bA228	Overload restriction 2 action time, 2nd-motor	0.10 to 3600.00 (s)	1.00		For details, refer to bA120 to bA149.
bA240	Overvoltage suppression enable, 2nd-motor	00(Disable)/ 01(Constant DC bus voltage control(deceleration stop))/ 02(Enable acceleration)/ 03(Enable acceleration (at constant speed and deceleration))	00		For the 2nd-motor control, see 12-17-1.
bA241	Overvoltage suppression active level, 2nd-motor	330.0 to 400.0 (VDC) (200V class) 660.0 to 800.0 (VDC) (400V class)	(200 V class) 380.0 (400V class) 760.0		
bA242	Overvoltage suppression active time, 2nd-motor	0.00 to 3600.00 (s)	1.00		
bA244	Constant DC bus voltage control P gain, 2nd-motor	0.00 to 5.00	0.20		
bA245	Constant DC bus voltage control I gain, 2nd-motor	0.00 to 150.00 (s)	1.00		
bA246	Over magnetization function selection, 2nd-motor	00(Disable)/ 01(Always enable)/ 02(At deceleration only)/ 03(Operation at setting level)/ 04(Operation at setting level at deceleration only)	02		
bA247	Over magnetization function output filter time constant, 2nd-motor	0.00 to 1.00 (s)	0.30		
bA248	Over magnetization function voltage gain, 2nd-motor	50 to 400 (%)	100		
bA249	Over magnetization function level setting, 2nd-motor	330.0 to 400.0 (VDC) (200V class) 660.0 to 800.0 (VDC) (400V class)	(200 V class) 360.0 (400V class) 720.0		

*1) 1.8 × Inverter rated current (A).

*2) 1.5 × Inverter rated current (A).

Code	Name	Data range	Initial value	Note	Page
bb101	Carrier frequency setting, 1st-motor	P1-550L / P1-550H or smaller: [Ub-03]=02(ND): 0.5 to 16.0 (kHz); [Ub-03]=01(LD): 0.5 to 12.0 (kHz); [Ub-03]=00(VLD): 0.5 to 10.0 (kHz); P1-750H or larger: [Ub-03]=02(ND): 0.5 to 10.0 (kHz); [Ub-03]=01(LD): 0.5 to 8.0 (kHz); [Ub-03]=00(VLD): 0.5 to 8.0 (kHz);	2.0		12-12-1
bb102	Sprinkle carrier pattern selection, 1st-motor	00(Disable)/ 01(Enable: Patern-1)/ 02(Enable: Patern-2)/ 03(Enable: Patern-3)	00		12-12-4
bb103	Automatic carrier reduction selection, 1st-motor	00(Disable)/ 01(Enable: Current)/ 02(Enable: Temperature)	00		12-12-2
bb-10	Automatic error reset selection	00(Disable)/ 01(If RUN command is OFF)/ 02(After set time)	00		12-24-19
bb-11	Alarm signal selection at automatic error reset	00(Enable)/ 01(Disable)	00		
bb-12	Automatic error reset wait time	0 to 600 (s)	2		
bb-13	Automatic error reset number	0 to 10	3		
bb-20	Number of retries after instantaneous power failure	0 to 16/ 255	0		
bb-21	Number of retries after under voltage	0 to 16/ 255	0		12-16-7
bb-22	Number of retries after overcurrent	0 to 5	0		12-13-13
bb-23	Number of retries after over voltage	0 to 5	0		12-13-15
bb-24	Restart mode selection after instantaneous power failure/under-voltage error	00(Restart at 0Hz)/ 01(Restart with frequency matching)/ 02(Restart with active frequency matching)/ 03(Detect speed)/ *1) 04(Decelerate and stop with frequency matching and then trip)	01		12-16-7
bb-25	Instantaneous power failure allowed time	0.3 to 25.0 (s)	1.0		
bb-26	Retry wait time after instantaneous power failure/under-voltage error	0.3 to 100.0 (s)	0.3		
bb-27	Enable instantaneous power failure/ under-voltage trip while in stop status	00(Disable)/ 01(Enable)/ 02(Disable at Stop/Decel. Stop)	00		
bb-28	Restart mode selection after an overcurrent error	00(Restart at 0Hz)/ 01(Restart with frequency matching)/ 02(Restart with active frequency matching)/ 03(Detect speed)/ *1) 04(Decelerate and stop with frequency matching and then trip)	01		12-13-13
bb-29	Retry wait time after an overcurrent error	0.3 to 100.0 (s)	0.3		12-13-13
bb-30	Restart mode selection after an overvoltage error	00(Restart at 0Hz)/ 01(Restart with frequency matching)/ 02(Restart with active frequency matching)/ 03(Detect speed)/ *1) 04(Decelerate and stop with frequency matching and then trip)	01		12-13-15
bb-31	Retry wait time after an overvoltage error	0.3 to 100.0 (s)	0.3		12-13-15
bb-40	Restart mode after FRS release	00(Restart at 0Hz)/ 01(Restart with frequency matching)/ 02(Restart with active frequency matching)/ 03(Detect speed) *1)	00		12-14-12
bb-41	Restart mode after RS release	00(Restart at 0Hz)/ 01(Restart with frequency matching)/ 02(Restart with active frequency matching)/ 03(Detect speed) *1)	00		12-14-9
bb-42	Frequency matching minimum restart frequency	0.00 to 590.00 (Hz)	0.00		12-14-3

*1) Requires encoder feedback to the P1-FB option or the input terminal 103[PLA]/104[PLB] assigned [A]/[B] terminals.

Code	Name	Data range	Initial value	Note	Page
bb-43	Active frequency matching restart level	(0.2 to 2.0)× Inverter rated current (A)	1.0 × Inverter rated current		12-14-6
bb-44	Active frequency matching restart constant (speed)	0.10 to 30.00 (s)	0.50		
bb-45	Active frequency matching restart constant (voltage)	0.10 to 30.00 (s)	0.50		
bb-46	OC-suppress level at active frequency matching	(0.0 to 2.0)× Inverter rated current (A)	1.0 × Inverter rated current		
bb-47	Active frequency matching restart speed selection	00(Output frequency at shut down)/ 01(Maximum frequency)/ 02(Setting frequency)	00		
bb-50 *2)	Frequency matching filter gain	0 to 1000 (%)	50		21-35
bb160 *1)	Overcurrent detection level, 1st-motor	(0.2 to 2.2) × Inverter ND rated current (A)	2.2 × Inverter ND rated current		12-16-5
bb-61	Power supply overvoltage selection	00(Warning)/ 01(Error)	00		12-19-17
bb-62	Power supply overvoltage level setting	300.0 to 410.0 (VDC) (200V class) 600.0 to 820.0 (VDC) (400V class)	(200 V class) 390.0 (400V class) 780.0		
bb-64	Detect ground fault selection	00(Disable)/ 01(Enable)	01		18-16
bb-65	Input phase loss detection enable	00(Disable)/ 01(Enable)	00		12-16-1
bb-66	Output phase loss detection enable	00(Disable)/ 01(Enable)	00		12-16-2
bb-67	Output phase loss detection sensitivity	1 to 100 (%)	10		
bb-70	Thermistor error level	0 to 10000 (Ω)	3000		12-7-6
bb-80	Over-speed detection level	0.0 to 150.0 (%)	135.0		12-16-12
bb-81	Over-speed detection time	0.0 to 5.0 (s)	0.5		
bb-82	Speed deviation error mode selection	00(Warning)/ 01(Error)	00		12-16-11
bb-83	Speed deviation error detection level	0.0 to 100.0 (%)	15.0		
bb-84	Speed deviation error detection time	0.0 to 5.0 (s)	0.5		
bb-85	Position deviation error mode selection	00(Warning)/ 01(Error)	00		12-17-18
bb-86	Position deviation error detection level	0 to 65535 (×100pls)	4096		
bb-87	Position deviation error detection time	0.0 to 5.0 (s)	0.5		
bb201	Carrier frequency setting, 2nd-motor	P1-550L / P1-550H or smaller: [Ub-03]=02(ND): 0.5 to 16.0(kHz); [Ub-03]=01(LD): 0.5 to 12.0(kHz); [Ub-03]=00(VLD): 0.5 to 10.0(kHz); P1-750H or larger: [Ub-03]=02(ND): 0.5 to 10.0(kHz); [Ub-03]=01(LD): 0.5 to 8.0(kHz); [Ub-03]=00(VLD): 0.5 to 8.0(kHz);	2.0		For details, refer to bb101 to bA160.
bb202	Sprinkle carrier pattern selection, 2nd-motor	00(Disable)/ 01(Enable: Patern-1)/ 02(Enable: Patern-2)/ 03(Enable: Patern-3)	00		For the 2nd-motor control, see 12-17-1.
bb203	Automatic carrier reduction selection, 2nd-motor	00(Disable)/ 01(Enable: Current)/ 02(Enable: Temperature)	00		
bb260 *1)	Overcurrent detection level, 2nd-motor	(0.2 to 2.2) × Inverter ND rated current (A)	2.2 × Inverter rated current		

*1) The setting range of [bb160]/[bb260] is 0.2 to 2.2 times the rated current at normal load rating (ND) regardless of the setting of [Ub-03] "Load type selection".

*2) [bb-50] is added to Ver2.03 or later.

Code	Name	Data range	Initial value	Note	Page
bC110	Electronic thermal level setting, 1st-motor	(0.0 to 3.0)× Inverter rated current (A)	1.0× Inverter rated current		12-7-1
bC111	Electronic thermal characteristic selection, 1st-motor	00(Reduced torque (VT))/ 01(Constant torque (CT))/ 02(Free setting)	00 (*FF)/ 01 (*FEF, *FUF, *FCF)		12-7-1
bC112	Electronic thermal decrease function enable, 1st-motor	00(Disable)/ 01(Enable)	01		12-7-4
bC113	Electronic thermal decreasing time, 1st-motor	1 to 1000 (s)	600		12-7-4
bC-14	Store electronic thermal counter at power-off	00(Disable)/ 01(Enable)	01		12-7-5
bC120	Free electronic thermal frequency-1, 1st-motor	0.00 to [bC122] (Hz)	0.00		12-7-3
bC121	Free electronic thermal current-1, 1st-motor	(0.0 to 3.0) × Inverter rated current (A)	0.0		
bC122	Free electronic thermal frequency-2, 1st-motor	[bC120] to [bC124] (Hz)	0.00		
bC123	Free electronic thermal current-2, 1st-motor	(0.0 to 3.0) × Inverter rated current (A)	0.0		
bC124	Free electronic thermal frequency-3, 1st-motor	[bC122] to 590.00 (Hz)	0.00		
bC125	Free electronic thermal current-3, 1st-motor	(0.0 to 3.0) × Inverter rated current (A)	0.0		
bC210	Electronic thermal level setting, 2nd-motor	(0.0 to 3.0) × Inverter rated current (A)	1.0× Inverter rated current		For details, refer to bC110 to bC125. For the 2nd-motor control, see 12-17-1.
bC211	Electronic thermal characteristic selection, 2nd-motor	00(Reduced torque (VT))/ 01(Constant torque (CT))/ 02(Free setting)	00 (*FF)/ 01 (*FEF, *FUF, *FCF)		
bC212	Electronic thermal decrease function selection, 2nd-motor	00(Disable)/ 01(Enable)	01		
bC213	Electronic thermal decreasing time, 2nd-motor	1 to 1000 (s)	600		
bC220	Free electronic thermal frequency-1, 2nd-motor	0.00 to [bC222] (Hz)	0.00		
bC221	Free electronic thermal current-1, 2nd-motor	(0.0 to 3.0)× Inverter rated current (A)	0.0		
bC222	Free electronic thermal frequency-2, 2nd-motor	[bC220] to [bC224] (Hz)	0.00		
bC223	Free electronic thermal current-2, 2nd-motor	(0.0 to 3.0)× Inverter rated current (A)	0.0		
bC224	Free electronic thermal frequency-3, 2nd-motor	[bC222] to 590.00 (Hz)	0.00		
bC225	Free electronic thermal current-3, 2nd-motor	(0.0 to 3.0)× Inverter rated current (A)	0.0		

Code	Name	Data range	Initial value	Note	Page
bd-01	STO input display selection	00(Warning(display))/ 01(Warning(without display))/ 02(Trip)	00		21-37
bd-02	STO input change time	0.00 to 60.00 (s)	1.00		21-37
bd-03	Display selection during STO input change time	00(Warning(display))/ 01(Warning(without display))	00		21-37
bd-04	Action selection after STO input change time	00(Maintain current status)/ 01(Disable)/ 02(Trip)	00		21-37

■ Parameter mode (code C).

Code	Name	Data range	Initial value	Note	Page
CA-01	Input terminal [1] function	See <List of input terminal functions>	028		12-24-1
CA-02	Input terminal [2] function		015		
CA-03	Input terminal [3] function		029		
CA-04	Input terminal [4] function		032		
CA-05	Input terminal [5] function		031		
CA-06	Input terminal [6] function		003		
CA-07	Input terminal [7] function		004		
CA-08	Input terminal [8] function		002		
CA-09	Input terminal [9] function		001		
CA-10	Input terminal [A] function		033		
CA-11	Input terminal [B] function		034		
CA-21	Input terminal [1] active state	00(Normally Open: NO)/ 01(Normally Closed: NC)	00		12-24-4
CA-22	Input terminal [2] active state		00		
CA-23	Input terminal [3] active state		00		
CA-24	Input terminal [4] active state		00		
CA-25	Input terminal [5] active state		00		
CA-26	Input terminal [6] active state		00		
CA-27	Input terminal [7] active state		00		
CA-28	Input terminal [8] active state		00		
CA-29	Input terminal [9] active state		00		
CA-30	Input terminal [A] active state		00		
CA-31	Input terminal [B] active state		00		
CA-41	Input terminal [1] response time	0 to 400 (ms)	2		12-24-5
CA-42	Input terminal [2] response time		2		
CA-43	Input terminal [3] response time		2		
CA-44	Input terminal [4] response time		2		
CA-45	Input terminal [5] response time		2		
CA-46	Input terminal [6] response time		2		
CA-47	Input terminal [7] response time		2		
CA-48	Input terminal [8] response time		2		
CA-49	Input terminal [9] response time		2		
CA-50	Input terminal [A] response time		2		
CA-51	Input terminal [B] response time		2		
CA-55	Multistage input determination time	0 to 2000 (ms)	0		12-4-12

<List of input terminal functions>

Function No.	Abbreviation	Function name	Page
000	no	Not use	-
001	FW	Forward rotation	12-5-3
002	RV	Reverse rotation	12-5-3
003	CF1	Multi speed selection 1	12-4-13
004	CF2	Multi speed selection 2	12-4-13
005	CF3	Multi speed selection 3	12-4-13
006	CF4	Multi speed selection 4	12-4-13
007	SF1	Multi speed Bit-1	12-4-14
008	SF2	Multi speed Bit-2	12-4-14
009	SF3	Multi speed Bit-3	12-4-14
010	SF4	Multi speed Bit-4	12-4-14
011	SF5	Multi speed Bit-5	12-4-14
012	SF6	Multi speed Bit-6	12-4-14
013	SF7	Multi speed Bit-7	12-4-14
014	ADD	Trigger for frequency addition	12-4-15
015	SCHG	Main/Sub speed reference change	12-4-10
016	STA	3-wire Start	12-5-4
017	STP	3-wire Stop	12-5-4
018	F/R	3-wire Forward/Reverse	12-5-4
019	AHD	analog command holding	12-4-17
020	FUP	Remote control Speed-UP function	12-4-16
021	FDN	Remote control Speed-DOWN function	12-4-16
022	UDC	Remote control Speed data clearing	12-4-16
023	F-OP	Force operation	12-4-18 12-5-7
024	SET	2nd-motor control	12-17-1
028	RS	Reset	12-24-6
029	JG	Jogging	12-17-4
030	DB	External DC braking	12-15-5
031	2CH	2-stage Acceleration/Deceleration	12-8-3
032	FRS	Free run stop	12-14-11 12-15-1
033	EXT	External fault	12-16-3
034	USP	unattended start protection	12-16-4
035	CS	Commercial power supply change	12-17-2
036	SFT	Soft-Lock	9-24
037	BOK	Answer back from Brake	12-17-5
038	OLR	Overload restriction selection	12-13-2
039	KHC	Accumulation input power clearance	13-14
040	OKHC	Accumulation output power clearance	13-15
041	PID	Disable PID1	12-10-13
042	PIDC	PID1 integration reset	12-10-13
043	PID2	Disable PID2	12-10-27
044	PIDC2	PID2 integration reset	12-10-27
045	PID3	Disable PID3	12-10-27
046	PIDC3	PID3 integration reset	12-10-27
047	PID4	Disable PID4	12-10-27
048	PIDC4	PID4 integration reset	12-10-27
051	SVC1	Multi set-point selection 1	12-10-9
052	SVC2	Multi set-point selection 2	12-10-9
053	SVC3	Multi set-point selection 3	12-10-9
054	SVC4	Multi set-point selection 4	12-10-9

Function No.	Abbreviation	Function name	Page
055	PRO	PID gain change	12-10-14
056	PIO1	PID output switching 1	12-10-22
057	PIO2	PID output switching 2	12-10-22
058	SLEP	SLEEP condition activation	12-10-17
059	WAKE	WAKE condition activation	12-10-17
060	TL	Torque limit enable *1)	12-11-7
061	TRQ1	Torque limit selection bit1 *1)	12-11-7
062	TRQ2	Torque limit selection bit2 *1)	12-11-7
063	PPI	P/PI control mode selection	12-11-2 12-11-5
064	CAS	Control gain change	12-11-2 12-11-5
065	SON	Servo-on	12-17-33
066	FOC	Forcing	12-14-13
067	ATR	Permission of torque control *1)	12-11-13
068	TBS	Torque Bias enable *1)	12-11-11
069	ORT	Home search function	12-17-22
071	LAC	Acceleration/Deceleration cancellation	12-8-11
072	PCLR	Clearance of position deviation	12-17-21 12-17-25
073	STAT	Pulse train position reference input enable	12-17-17
074	PUP	Position bias (ADD)	12-17-21
075	PDN	Position bias (SUB)	12-17-21
076	CP1	Multistage position settings selection 1	12-17-27
077	CP2	Multistage position settings selection 2	12-17-27
078	CP3	Multistage position settings selection 3	12-17-27
079	CP4	Multistage position settings selection 4	12-17-27
080	ORL	Limit signal of Homing function	12-17-29
081	ORG	Start signal of Homing function	12-17-29
082	FOT	Forward Over Travel	12-17-30
083	ROT	Reverse Over Travel	12-17-30
084	SPD	speed / position switching	12-17-27
085	PSET	Position data presetting	12-17-30

*1) These torque related functions are valid when the Control mode selection [AA121] / [AA221] is set to 08(IM-SLV), 09(IM-0Hz-SLV), or 10(IM-CLV). [ATR] is valid at 08 or 10.

Function No.	Abbreviation	Function name	Page
086	MI1	General-purpose input 1	16-6
087	MI2	General-purpose input 2	16-6
088	MI3	General-purpose input 3	16-6
089	MI4	General-purpose input 4	16-6
090	MI5	General-purpose input 5	16-6
091	MI6	General-purpose input 6	16-6
092	MI7	General-purpose input 7	16-6
093	MI8	General-purpose input 8	16-6
094	MI9	General-purpose input 9	16-6
095	MI10	General-purpose input 10	16-6
096	MI11	General-purpose input 11	16-6
097	PCC	Pulse counter clearing	12-24-16
098	ECOM	EzCOM activation	14-22
099	PRG	Program RUN	16-6
100	HLD	Acceleration/Deceleration disable	12-8-8
101	REN	RUN enable	12-6-4
102	DISP	Display lock	9-39 12-5-6
103	PLA	Pulse count A	12-9-35 12-24-16
104	PLB	Pulse count B	12-9-35 12-24-16
105	EMF	Emergency-Force Drive activation	12-17-13
107	COK	Contactora check signal	12-17-10
108	DTR	Data trace start	16-8
109	PLZ	Pulse train input Z	12-17-22
110	TCH	Teach-in	12-17-28

Code	Name	Data range	Initial value	Note	Page
CA-60	FUP/FDN overwrite target selection	00(Speed Reference)/ 01(PID1 Setpoint)	00		12-4-17
CA-61	FUP/FDN data save enable	00(Not save)/ 01(Save)	00		
CA-62	FUP/FDN UDC selection	00(0Hz)/ 01(Saved data)	00		
CA-64	Acceleration time setting for FUP/FDN function	0.00 to 3600.00 (s)	30.00		
CA-66	Deceleration time setting for FUP/FDN function	0.00 to 3600.00 (s)	30.00		
CA-70	Speed reference source selection when [F-OP] is active	01(Terminal[Ai1])/ 02(Terminal[Ai2])/ 03(Terminal[Ai3])/ 04(Terminal[Ai4])/ 05(Terminal[Ai5])/ 06(Terminal[Ai6])/ 07(Parameter Setting)/ 08(RS485)/ 09(Option-1)/ 10(Option-2)/ 11(Option-3)/ 12(Pulse train input(internal))/ 13(Pulse train input(option))/ 14(Program function)/ 15(PID calc.)/ 16(MOP Keypad's VR)	01		12-5-7
CA-71	RUN command source selection when [F-OP] is active	00([FW]/[RV] terminal)/ 01(3-wire)/ 02(Keypad's RUN-key) / 03(RS485)/ 04(Option-1)/ 05(Option-2)/ 06(Option-3)	00		
CA-72	Reset mode selection	00(Always enabled (Trip release at turn-ON))/ 01(Always enabled (Trip release at turn-OFF))/ 02(Only enable in trip status (Trip release at turn-ON))/ 03(Only enable in trip status (Trip release at turn-OFF))	00		12-24-6
CA-81	Encoder constant setting (Internal)	32 to 65535 (pls)	1024		12-9-35
CA-82	Encoder phase sequence selection (Internal)	00(Phase-A Lead)/ 01(Phase-B Lead)	00		12-9-35
CA-83	Motor gear ratio numerator (Internal)	1 to 10000	1		12-9-35
CA-84	Motor gear ratio denominator (Internal)	1 to 10000	1		12-9-35
CA-90	Pulse train input, target function selection (Internal)	00(Disable)/ 01(Frequency reference)/ 02(Speed feedback)/ 03(Pulse count)	00		12-9-35
CA-91	Pulse train input mode selection (Internal)	00(90 degrees shift pulse train)/ 01(Forward/Reverse pulse train and direction signal)/ 02(Forward pulse train and reverse pulse train)	00		12-9-35
CA-92	Pulse train frequency scale (Internal)	0.05 to 32.00 (kHz)	25.00		12-4-5
CA-93	Pulse train frequency filter time constant (Internal)	0.01 to 2.00 (s)	0.10		12-4-5
CA-94	Pulse train frequency bias value (Internal)	-100.0 to 100.0 (%)	0.0		12-4-5
CA-95	Pulse train upper frequency detection level (Internal)	0 to 100.0 (%)	100.0		12-4-5
CA-96	Pulse train lower frequency detection level (Internal)	0 to 100.0 (%)	0.0		12-4-5
CA-97	Pulse counter compare match output ON value	0 to 65535	0		12-24-16
CA-98	Pulse counter compare match output OFF value	0 to 65535	0		12-24-16
CA-99	Pulse counter maximum value	0 to 65535	65535		12-24-16

Code	Name	Data range	Initial value	Note	Page
Cb-01	[Ai1] Filter time constant	1 to 500 (ms)	16		12-24-9
Cb-03	[Ai1] Start value	0.00 to 100.00 (%)	0.00		
Cb-04	[Ai1] End value	0.00 to 100.00 (%)	100.00		
Cb-05	[Ai1] Start rate	0.0 to [Cb-06] (%)	0.0		
Cb-06	[Ai1] End rate	[Cb-05] to 100.0 (%)	100.0		
Cb-07	[Ai1] Start value selection	00(Start value[Cb-03])/ 01(0%)	01		
Cb-11	[Ai2] Filter time constant	1 to 500 (ms)	16		
Cb-13	[Ai2] Start value	0.00 to 100.00 (%)	0.00		
Cb-14	[Ai2] End value	0.00 to 100.00 (%)	100.00		
Cb-15	[Ai2] Start rate	0.0 to [Cb-16] (%)	20.0		
Cb-16	[Ai2] End rate	[Cb-15] to 100.0 (%)	100.0		
Cb-17	[Ai2] Start value selection	00(Start value[Cb-13])/ 01(0%)	01		
Cb-21	[Ai3] Filter time constant	1 to 500 (ms)	16		12-24-11
Cb-22	Terminal [Ai3] selection	00(Single)/ 01(Added to Ai1/Ai2: Forward and Reverse)/ 02(Added to Ai1/Ai2: Forward only)	00		
Cb-23	[Ai3] Start value	-100.00 to 100.00 (%)	-100.00		
Cb-24	[Ai3] End value	-100.00 to 100.00 (%)	100.00		
Cb-25	[Ai3] Start rate	-100.0 to [Cb-26] (%)	-100.0		
Cb-26	[Ai3] End rate	[Cb-25] to 100.0 (%)	100.0		
Cb-30	[Ai1] Voltage/Current bias adjustment	-100.00 to 100.00 (%)	0.00		12-24-13
Cb-31	[Ai1] Voltage/Current gain adjustment	0 to 200.00 (%)	100.00		
Cb-32	[Ai2] Voltage/Current bias adjustment	-100.00 to 100.00 (%)	0.00		
Cb-33	[Ai2] Voltage/Current gain adjustment	0 to 200.00 (%)	100.00		
Cb-34	[Ai3] Voltage bias adjustment	-100.00 to 100.00 (%)	0.00		
Cb-35	[Ai3] Voltage gain adjustment	0 to 200.00 (%)	100.00		
Cb-40	Thermistor type selection	00(Disable)/ 01(PTC)/ 02(NTC)	00		12-7-6
Cb-41	Thermistor gain adjustment	0.0 to 1000.0	100.0		

Code	Name	Data range	Initial value	Note	Page
Cb-51	MOP-VR input filter time constant	1 to 500	100		-
Cb-53	MOP-VR start value	0.00 to 100.00 (%)	0.00		
Cb-54	MOP-VR end value	0.00 to 100.00 (%)	100.00		
Cb-55	MOP-VR start ratio	0.0 to [Cb-56] (%)	0.0		
Cb-56	MOP-VR end ratio	[Cb-55] to 100.0 (%)	100.0		
Cb-57	MOP-VR start selection	00(Start value[Cb-53])/ 01(0%)	01		

Code	Name	Data range	Initial value	Note	Page
CC-01	Output terminal [11] function	See <List of output terminal functions>	001		12-25-1
CC-02	Output terminal [12] function		002		
CC-03	Output terminal [13] function		003		
CC-04	Output terminal [14] function		007		
CC-05	Output terminal [15] function		035		
CC-06	Output terminal [16] function		000 *1)		
CC-07	Output terminal [AL] function		017		
CC-11	Output terminal [11] active state	00(Normally Open: NO)/ 01(Normally Closed: NC)	00		12-25-4
CC-12	Output terminal [12] active state		00		
CC-13	Output terminal [13] active state		00		
CC-14	Output terminal [14] active state		00		
CC-15	Output terminal [15] active state		00		
CC-16	Output terminal [16] active state		00		
CC-17	Output terminal [AL] active state		01		
CC-20	Output terminal [11] on-delay time	0.00 to 100.00 (s)	0.00		12-25-6
CC-21	Output terminal [11] off-delay time	0.00 to 100.00 (s)	0.00		
CC-22	Output terminal [12] on-delay time	0.00 to 100.00 (s)	0.00		
CC-23	Output terminal [12] off-delay time	0.00 to 100.00 (s)	0.00		
CC-24	Output terminal [13] on-delay time	0.00 to 100.00 (s)	0.00		
CC-25	Output terminal [13] off-delay time	0.00 to 100.00 (s)	0.00		
CC-26	Output terminal [14] on-delay time	0.00 to 100.00 (s)	0.00		
CC-27	Output terminal [14] off-delay time	0.00 to 100.00 (s)	0.00		
CC-28	Output terminal [15] on-delay time	0.00 to 100.00 (s)	0.00		
CC-29	Output terminal [15] off-delay time	0.00 to 100.00 (s)	0.00		
CC-30	Output terminal [16] on-delay time	0.00 to 100.00 (s)	0.00		
CC-31	Output terminal [16] off-delay time	0.00 to 100.00 (s)	0.00		
CC-32	Output terminal [AL] on-delay time	0.00 to 100.00 (s)	0.00		
CC-33	Output terminal [AL] off-delay time	0.00 to 100.00 (s)	0.00		

*1) The initial value Ver2.01 or older is 040[ZS].

<List of output terminal functions>

Function No.	Abbreviation	Function name	Page
000	no	Not use	-
001	RUN	Running	12-20-1
002	FA1	Constant-frequency reached	12-21-1
003	FA2	Set frequency overreached	12-21-2
004	FA3	Set frequency reached	12-21-3
005	FA4	Set frequency overreached 2	12-21-2
006	FA5	Set frequency reached	12-21-3
007	IRDY	Inverter ready	12-20-4
008	FWR	Forward rotation	12-20-2
009	RVR	Reverse rotation	12-20-2
010	FREF	Frequency reference = Keypad is selected	12-4-2
011	REF	Run command = Keypad is selected	12-5-2
012	SETM	2nd control is selected	12-17-1
016	OPO	Option output *1)	—
017	AL	Alarm	12-19-1
018	MJA	Major failure	12-19-3
019	OTQ	Over-torque *2)	12-11-9
020	IP	Instantaneous power failure	12-19-8
021	UV	Undervoltage	12-19-9
022	TRQ	Torque limited *2)	12-11-7
023	IPS	IP-Non stop function is active	12-13-17
024	RNT	Accumulated operation time over	12-19-15
025	ONT	Accumulated power-on time over	12-19-16
026	THM	Electronic thermal alarm (Motor)	12-19-10
027	THC	Electronic thermal alarm (Inverter)	12-19-11
029	WAC	Capacitor life warning	12-19-13
030	WAF	Cooling-fan speed drop	12-19-14
031	FR	RUN command active	12-20-3
032	OHF	Heat sink overheat warning	12-19-12
033	LOC	Low-current indication	12-19-7
034	LOC2	Low-current indication 2	12-19-7
035	OL	Overload warning notice	12-19-6
036	OL2	Overload warning notice 2	12-19-6
037	BRK	Brake release	12-17-5
038	BER	Brake error	12-17-5
039	CON	Contact control	12-17-10
040	ZS	Zero speed detection	12-21-4
041	DSE	Speed over deviation	12-16-11
042	PDD	Position over deviation	12-17-21
043	POK	Positioning completed	12-17-22 12-17-25
044	PCMP	Pulse count compare match output	12-24-16
045	OD	Over deviation for PID control	12-10-28
046	FBV	PID1 feedback comparison	12-10-29
047	OD2	Over deviation for PID2 control	12-10-28
048	FBV2	PID2 feedback comparison	12-10-29
049	NDc	Communication line disconnection	14-5

Function No.	Abbreviation	Function name	Page
050	Ai1Dc	Analog [Ai1] disconnection detection	12-22-1
051	Ai2Dc	Analog [Ai2] disconnection detection	12-22-1
052	Ai3Dc	Analog [Ai3] disconnection detection	12-22-1
053	Ai4Dc	Analog [Ai4] disconnection detection	12-22-4
054	Ai5Dc	Analog [Ai5] disconnection detection	12-22-4
055	Ai6Dc	Analog [Ai6] disconnection detection	12-22-4
056	WCAi1	Window comparator Ai1	12-22-1
057	WCAi2	Window comparator Ai2	12-22-1
058	WCAi3	Window comparator Ai3	12-22-1
059	WCAi4	Window comparator Ai4	12-22-4
060	WCAi5	Window comparator Ai5	12-22-4
061	WCAi6	Window comparator Ai6	12-22-4
062	LOG1	Logical operation result 1	12-23-1
063	LOG2	Logical operation result 2	
064	LOG3	Logical operation result 3	
065	LOG4	Logical operation result 4	
066	LOG5	Logical operation result 5	
067	LOG6	Logical operation result 6	
068	LOG7	Logical operation result 7	
069	MO1	General-purpose output 1	16-6
070	MO2	General-purpose output 2	
071	MO3	General-purpose output 3	
072	MO4	General-purpose output 4	
073	MO5	General-purpose output 5	
074	MO6	General-purpose output 6	
075	MO7	General-purpose output 7	
076	EMFC	Emergency force drive indicator	12-17-13
077	EMBP	Bypass mode indicator	12-17-15
078	WFT	Trace function waiting for trigger	16-7
079	TRA	Trace function data logging	16-7
080	LBK	Low-battery of keypad	9-41
081	OVS	Over-Voltage power Supply	12-19-17
084	AC0	Alarm code bit-0	12-19-4
085	AC1	Alarm code bit-1	
086	AC2	Alarm code bit-2	
087	AC3	Alarm code bit-3	
089	OD3	Over deviation for PID3 control	12-10-28
090	FBV3	PID3 feedback comparison	12-10-29
091	OD4	Over deviation for PID4 control	12-10-28
092	FBV4	PID4 feedback comparison	12-10-29
093	SSE	PID soft start error	12-10-16

*1) [OPO] "Option output" function is not currently functioning for future expansion. Therefore, do not assign.

*2) These torque related functions are valid when the Control mode selection [AA121] / [AA221] is set to 08(IM-SLV), 09(IM-0Hz-SLV), or 10(IM-CLV).

Code	Name	Data range	Initial value	Note	Page
CC-40	LOG1 operand-1 selection	See <List of output terminal functions>	000		12-23-1
CC-41	LOG1 operand-2 selection	See <List of output terminal functions>	000		
CC-42	LOG1 logical calculation selection	00(AND)/ 01(OR) / 02(XOR)	00		
CC-43	LOG2 operand-1 selection	See <List of output terminal functions>	000		
CC-44	LOG2 operand-2 selection	See <List of output terminal functions>	000		
CC-45	LOG2 logical calculation selection	00(AND)/ 01(OR) / 02(XOR)	00		
CC-46	LOG3 operand-1 selection	See <List of output terminal functions>	000		
CC-47	LOG3 operand-2 selection	See <List of output terminal functions>	000		
CC-48	LOG3 logical calculation selection	00(AND)/ 01(OR) / 02(XOR)	00		
CC-49	LOG4 operand-1 selection	See <List of output terminal functions>	000		
CC-50	LOG4 operand-2 selection	See <List of output terminal functions>	000		
CC-51	LOG4 logical calculation selection	00(AND)/ 01(OR) / 02(XOR)	00		
CC-52	LOG5 operand-1 selection	See <List of output terminal functions>	000		
CC-53	LOG5 operand-2 selection	See <List of output terminal functions>	000		
CC-54	LOG5 logical calculation selection	00(AND)/ 01(OR) / 02(XOR)	00		
CC-55	LOG6 operand-1 selection	See <List of output terminal functions>	000		
CC-56	LOG6 operand-2 selection	See <List of output terminal functions>	000		
CC-57	LOG6 logical calculation selection	00(AND)/ 01(OR) / 02(XOR)	00		
CC-58	LOG7 operand-1 selection	See <List of output terminal functions>	000		
CC-59	LOG7 operand-2 selection	See <List of output terminal functions>	000		
CC-60	LOG7 logical calculation selection	00(AND)/ 01(OR) / 02(XOR)	00		

Code	Name	Data range	Initial value	Note	Page
Cd-01	[FM] Output wave form selection	00(PWM output)/ 01(Frequency output)	00		12-25-9
Cd-02	[FM] Output base frequency (at frequency output)	0 to 3600 (Hz)	2880		
Cd-03	[FM] Output monitor selection	See <List of output monitor functions>	[dA-01]		
Cd-04	[Ao1] Output monitor selection	See <List of output monitor functions>	[dA-01]		12-25-13
Cd-05	[Ao2] Output monitor selection	See <List of output monitor functions>	[dA-01]		
Cd-10	Analog monitor adjustment mode enable	00(Disable)/ 01(Enable)	00		
Cd-11	[FM] Output filter time constant	1 to 500 (ms)	100		12-25-9
Cd-12	[FM] Data type selection	00(Absolute data)/ 01(Signed data)	00		
Cd-13	[FM] Bias adjustment	-100.0 to 100.0 (%)	0.0		
Cd-14	[FM] Gain adjustment	-1000.0 to 1000.0 (%)	100.0		
Cd-15	Adjustment mode [FM] output level	-100.0 to 100.0 (%)	100.0		
Cd-21	[Ao1] Output filter time constant	1 to 500 (ms)	100		12-25-13
Cd-22	[Ao1] Data type selection	00(Absolute data)/ 01(Signed data)	00		
Cd-23	[Ao1] Bias adjustment	-100.0 to 100.0 (%)	0.0		
Cd-24	[Ao1] Gain adjustment	-1000.0 to 1000.0 (%)	100.0		
Cd-25	Adjustment mode [Ao1] output level	-100.0 to 100.0 (%)	100.0		
Cd-31	[Ao2] Output filter time constant	1 to 500 (ms)	100		
Cd-32	[Ao2] Data type selection	00(Absolute data)/ 01(Signed data)	00		
Cd-33	[Ao2] Bias adjustment	-100.0 to 100.0 (%)	20.0		
Cd-34	[Ao2] Gain adjustment	-1000.0 to 1000.0 (%)	80.0 *1)		
Cd-35	Adjustment mode [Ao2] output level	-100.0 to 100.0 (%)	100.0		

*1) The initial value Ver2.01 or older is 100.0.

<List of output monitor functions>

Monitor Code.	Function
dA-01	Output frequency monitor
dA-02	Output current monitor
dA-04	Frequency reference monitor (after calculation)
dA-08	Detect speed monitor
dA-12	Output frequency monitor (signed)
dA-14	Frequency upper limit monitor
dA-15	Torque reference monitor (after calculation) *1)
dA-16	Torque limit monitor *1)
dA-17	Output torque monitor *1)
dA-18	Output voltage monitor (RMS)
dA-30	Input power monitor
dA-34	Output power monitor
dA-38	Motor temperature monitor
dA-40	DC bus voltage monitor
dA-41	BRD load rate monitor
dA-42	Electronic thermal load rating monitor (Motor)
dA-43	Electronic thermal load rating monitor (Inverter)
dA-61	Analog input [Ai1] monitor
dA-62	Analog input [Ai2] monitor
dA-63	Analog input [Ai3] monitor
dA-64	Analog input [Ai4] monitor
dA-65	Analog input [Ai5] monitor
dA-66	Analog input [Ai6] monitor
dA-70	Pulse train input monitor (internal)
dA-71	Pulse train input monitor (option)
db-18	Analog output monitor YA0
db-19	Analog output monitor YA1
db-20	Analog output monitor YA2
db-21	Analog output monitor YA3
db-22	Analog output monitor YA4
db-23	Analog output monitor YA5

Monitor Code.	Function
db-30	PID1 feedback value 1 monitor
db-32	PID1 feedback value 2 monitor
db-34	PID1 feedback value 3 monitor
db-36	PID2 feedback value monitor
db-38	PID3 feedback value monitor
db-40	PID4 feedback value monitor
db-42	PID1 target value monitor (after calculation)
db-44	PID1 feedback value monitor (after calculation)
db-50	PID1 output monitor
db-51	PID1 deviation monitor
db-52	PID1 deviation 1 monitor
db-53	PID1 deviation 2 monitor
db-54	PID1 deviation 3 monitor
db-55	PID2 output monitor
db-56	PID2 deviation monitor
db-57	PID3 output monitor
db-58	PID3 deviation monitor
db-59	PID4 output monitor
db-60	PID4 deviation monitor
db-64	PID feedforward monitor
dC-15	Cooling fin temperature monitor
FA-01	Main speed reference setting or monitor
FA-02	Sub-speed reference setting or monitor
FA-15	Torque reference setting or monitor *1)
FA-16	Torque bias setting or monitor *1)
FA-30	PID1 set-point 1 setting or monitor
FA-32	PID1 set-point 2 setting or monitor
FA-34	PID1 set-point 3 setting or monitor
FA-36	PID2 set-point setting or monitor
FA-38	PID3 set-point setting or monitor
FA-40	PID4 set-point setting or monitor

*1) These torque related functions are valid when the Control mode selection [AA121] / [AA221] is set to 08(IM-SLV), 09(IM-0Hz-SLV), or 10(IM-CLV). [dA-15]/[FA-15] are valid at 08 or 10.

Code	Name	Data range	Initial value	Note	Page
CE101	Low current signal output mode selection, 1st motor	00(During Accel./Decel. and constant speed)/ 01(During constant speed only)	01		12-19-7
CE102	Low current detection level 1, 1st motor	(0.0 to 2.0) × Inverter rated current (A)	1.0×Inverter rated current		
CE103	Low current detection level 2, 1st motor	(0.0 to 2.0)× Inverter rated current (A)	1.0×Inverter rated current		
CE105	Overload signal output mode selection, 1st motor	00(During Accel./Decel. and constant speed)/ 01(During constant speed only)	01		12-19-6
CE106	Overload warning level 1, 1st motor	(0.0 to 2.0)× Inverter rated current (A)	1.0×Inverter rated current		
CE107	Overload warning level 2, 1st motor	(0.0 to 2.0)× Inverter rated current (A)	1.0×Inverter rated current		
CE-10	Arrival frequency 1 value setting during acceleration	0.00 to 590.00 (Hz)	0.00		12-21-2 12-21-3
CE-11	Arrival frequency 1 value setting during deceleration	0.00 to 590.00 (Hz)	0.00		
CE-12	Arrival frequency 2 value setting during acceleration	0.00 to 590.00 (Hz)	0.00		
CE-13	Arrival frequency 2 value setting during deceleration	0.00 to 590.00 (Hz)	0.00		
CE120	Over-torque level (Forward drive), 1st motor	0.0 to 500.0 (%)	100.0		12-11-9
CE121	Over-torque level (Reverse regenerative), 1st motor	0.0 to 500.0 (%)	100.0		
CE122	Over-torque level (Reverse drive), 1st motor	0.0 to 500.0 (%)	100.0		
CE123	Over-torque level (Forward regenerative), 1st motor	0.0 to 500.0 (%)	100.0		
CE-30	Electronic thermal warning level (Motor)	0.00 to 100.00 (%)	80.00		12-19-10
CE-31	Electronic thermal warning level (Inverter)	0.00 to 100.00 (%)	80.00		12-19-11
CE-33	Zero speed detection level	0.00 to 100.00 (Hz)	0.50		12-21-4
CE-34	Cooling fin overheat warning level	0 to 200 (degrees Celsius)	120		12-19-12
CE-36	Accum. RUN time (RNT) / Accum. Power-ON(ONT) time setting	0 to 100000 (hr)	0		12-19-15

Code	Name	Data range	Initial value	Note	Page
CE-40	[Ai1] Window comparator higher limit	0 to 100 (%)	100		12-22-1
CE-41	[Ai1] Window comparator lower limit	0 to 100 (%)	0		
CE-42	[Ai1] Window comparator hysteresis width	0 to 10 (%)	0		
CE-43	[Ai2] Window comparator higher limit	0 to 100 (%)	100		
CE-44	[Ai2] Window comparator lower limit	0 to 100 (%)	0		
CE-45	[Ai2] Window comparator hysteresis width	0 to 10 (%)	0		
CE-46	[Ai3] Window comparator higher limit	-100 to 100 (%)	100		
CE-47	[Ai3] Window comparator lower limit	-100 to 100 (%)	-100		
CE-48	[Ai3] Window comparator hysteresis width	0 to 10 (%)	0		
CE-50	[Ai1] Operation set level at disconnection or compare event	0 to 100 (%)	0		
CE-51	[Ai1] Operation set level implement timing	00(Disable)/ 01(Enable(at WC*active))/ 02(Enable(at WC*de-active))	00		
CE-52	[Ai2] Operation set level at disconnection or compare event	0 to 100 (%)	0		
CE-53	[Ai2] Operation set level implement timing	00(Disable)/ 01(Enable(at WC*active))/ 02(Enable(at WC*de-active))	00		
CE-54	[Ai3] Operation set level at disconnection or compare event	-100 to 100 (%)	0		
CE-55	[Ai3] Operation set level implement timing	00(Disable)/ 01(Enable(at WC*active))/ 02(Enable(at WC*de-active))	00		

Code	Name	Data range	Initial value	Note	Page
CE201	Low current signal output mode selection, 2nd-motor	00(During Accel./Decel. and constant speed)/ 01(During constant speed only)	01		For details, refer to CE101 to CE123. For the 2nd-motor control, see 12-17-1.
CE202	Low current detection level 1, 2nd-motor	(0.0 to 2.0) × Inverter rated current (A)	1.0×Inverter rated current		
CE203	Low current detection level 2, 2nd-motor	(0.0 to 2.0) × Inverter rated current (A)	1.0×Inverter rated current		
CE205	Overcurrent signal output mode selection, 2nd-motor	00(During Accel./Decel. and constant speed)/ 01(During constant speed only)	01		
CE206	Overcurrent detection level 1, 2nd-motor	(0.0 to 2.0) × Inverter rated current (A)	1.0×Inverter rated current		
CE207	Overcurrent detection level 2, 2nd-motor	(0.0 to 2.0) × Inverter rated current (A)	1.0×Inverter rated current		
CE220	Over-torque level (Forward drive), 2nd-motor	0.0 to 500.0 (%)	100.0		
CE221	Over-torque level (Reverse regenerative), 2nd-motor	0.0 to 500.0 (%)	100.0		
CE222	Over-torque level (Reverse drive), 2nd-motor	0.0 to 500.0 (%)	100.0		
CE223	Over-torque level (Forward regenerative), 2nd motor	0.0 to 500.0 (%)	100.0		

Code	Name	Data range	Initial value	Note	Page
CF-01	RS485 communication baud rate selection	03(2400bps)/ 04(4800bps)/ 05(9600bps)/ 06(19.2kbps)/ 07(38.4kbps)/ 08(57.6kbps)/ 09(76.8kbps)/ 10(115.2kbps)	05		14-5
CF-02	RS485 communication node address	1 to 247	1		
CF-03	RS485 communication parity selection	00(No parity)/ 01(Even parity)/ 02(Odd parity)	00		
CF-04	RS485 communication stop bit selection	01(1-bit)/ 02(2-bit)	01		
CF-05	RS485 communication error selection	00(Error)/ 01(Error output after Deceleration stop)/ 02(Ignore)/ 03(Free run stop)/ 04(Decelration stop)	02		
CF-06	RS485 communication timeout setting	0.00 to 100.00 (s)	0.00		
CF-07	RS485 communication wait time setting	0 to 1000 (ms)	2		
CF-08	RS485 communication mode selection	01(Modbus-RTU)/ 02(EzCOM)/ 03(EzCOM Administrator)	01		14-5 14-22
CF-11	Register data conversion function (A,V ↔%))	00(A, V)/ 01(%)	00		14-5
CF-20	EzCOM start node No.	1 to 8	1		14-22
CF-21	EzCOM end node No.	1 to 8	1		
CF-22	EzCOM start method selection	00(Terminal [EzCOM])/ 01(Always)	00		
CF-23	EzCOM data size	1 to 5	5		14-23
CF-24	EzCOM destination address 1	1 to 247	1		
CF-25	EzCOM destination register 1	0000 to FFFF	0000		
CF-26	EzCOM source register 1	0000 to FFFF	0000		
CF-27	EzCOM destination address 2	1 to 247	2		
CF-28	EzCOM destination register 2	0000 to FFFF	0000		
CF-29	EzCOM source register 2	0000 to FFFF	0000		
CF-30	EzCOM destination address 3	1 to 247	3		
CF-31	EzCOM destination register 3	0000 to FFFF	0000		
CF-32	EzCOM source register 3	0000 to FFFF	0000		
CF-33	EzCOM destination address 4	1 to 247	4		
CF-34	EzCOM destination register 4	0000 to FFFF	0000		
CF-35	EzCOM source register 4	0000 to FFFF	0000		
CF-36	EzCOM destination address 5	1 to 247	5		
CF-37	EzCOM destination register 5	0000 to FFFF	0000		
CF-38	EzCOM source register 5	0000 to FFFF	0000		
CF-50	USB communication node address	1 to 247	1		16-2

■ Parameter mode (code H).

Code	Name	Data range	Initial value	Note	Page
HA-01	Auto-tuning selection	00(Disable)/ 01(No-rotation)/ 02(Rotation)/ 03(IVMS)	00		12-3-6
HA-02	Auto-tuning RUN command source selection	00(Keypad "RUN" key)/ 01(Setting by [AA111] / [AA211])	00		
HA-03	Online auto-tuning selection	00(Disable)/ 01(Enable)	00		
HA110	Stabilization constant, 1st-motor	0 to 1000 (%)	100		12-9-3,12-9-4,12-9-6 12-9-7,12-9-11
HA112 *1)	Stabilization ramp function end ratio, 1st-motor	0 to 100(%)	30		21-35
HA113 *1)	Stabilization ramp function start ratio, 1st-motor	0 to 100(%)	10		21-35
HA115	Speed response, 1st-motor	0 to 1000 (%)	100		12-9-12,12-9-14, 12-9-24,12-9-28 12-9-31
HA120	ASR gain switching mode selection, 1st-motor	00([CAS] terminal)/ 01(Parameter setting)	00		12-11-4
HA121	ASR gain switching time setting, 1st-motor	0 to 10000 (ms)	100		
HA122	ASR gain mapping intermediate speed 1, 1st-motor	0.00 to 590.00 (Hz)	0.00		
HA123	ASR gain mapping intermediate speed 2, 1st-motor	0.00 to 590.00 (Hz)	0.00		
HA124	ASR gain mapping maximum speed, 1st-motor	0.00 to 590.00 (Hz)	0.00		
HA125	ASR gain mapping P-gain 1, 1st-motor	0.0 to 1000.0 (%)	100.0		
HA126	ASR gain mapping I-gain 1, 1st-motor	0.0 to 1000.0 (%)	100.0		
HA127	ASR gain mapping P control P-gain 1, 1st-motor	0.0 to 1000.0 (%)	100.0		
HA128	ASR gain mapping P-gain 2, 1st-motor	0.0 to 1000.0 (%)	100.0		
HA129	ASR gain mapping I-gain 2, 1st-motor	0.0 to 1000.0 (%)	100.0		
HA130	ASR gain mapping P control P-gain 2, 1st-motor	0.0 to 1000.0 (%)	100.0		
HA131	ASR gain mapping P-gain 3, 1st-motor	0.0 to 1000.0 (%)	100.0		
HA132	ASR gain mapping I-gain 3, 1st-motor	0.0 to 1000.0 (%)	100.0		
HA133	ASR gain mapping P-gain 4, 1st-motor	0.0 to 1000.0 (%)	100.0		
HA134	ASR gain mapping I-gain 4, 1st-motor	0.0 to 1000.0 (%)	100.0		
HA210	Stabilization constant, 2nd-motor	0 to 1000 (%)	100		For details, refer to HA110 to HA134. For the 2nd-motor control, see 12-17-1.
HA212 *1)	Stabilization ramp function end ratio, 2nd-motor	0 to 100(%)	30		
HA213 *1)	Stabilization ramp function start ratio, 2nd-motor	0 to 100(%)	10		
HA215	Speed response, 2nd-motor	0 to 1000 (%)	100		
HA220	ASR gain switching mode selection, 2nd-motor	00([CAS] terminal)/ 01(Parameter setting)	00		
HA221	ASR gain switching time setting, 2nd-motor	0 to 10000 (ms)	100		
HA222	ASR gain mapping intermediate speed 1, 2nd-motor	0.00 to 590.00 (Hz)	0.00		
HA223	ASR gain mapping intermediate speed 2, 2nd-motor	0.00 to 590.00 (Hz)	0.00		
HA224	ASR gain mapping maximum speed, 2nd-motor	0.00 to 590.00 (Hz)	0.00		
HA225	ASR gain mapping P-gain 1, 2nd-motor	0.0 to 1000.0 (%)	100.0		
HA226	ASR gain mapping I-gain 1, 2nd-motor	0.0 to 1000.0 (%)	100.0		
HA227	ASR gain mapping P control P-gain 1, 2nd-motor	0.0 to 1000.0 (%)	100.0		
HA228	ASR gain mapping P-gain 2, 2nd-motor	0.0 to 1000.0 (%)	100.0		
HA229	ASR gain mapping I-gain 2, 2nd-motor	0.0 to 1000.0 (%)	100.0		
HA230	ASR gain mapping P control P-gain 2, 2nd-motor	0.0 to 1000.0 (%)	100.0		
HA231	ASR gain mapping P-gain 3, 2nd-motor	0.0 to 1000.0 (%)	100.0		
HA232	ASR gain mapping I-gain 3, 2nd-motor	0.0 to 1000.0 (%)	100.0		
HA233	ASR gain mapping P-gain 4, 2nd-motor	0.0 to 1000.0 (%)	100.0		
HA234	ASR gain mapping I-gain 4, 2nd-motor	0.0 to 1000.0 (%)	100.0		

*1) These are the parameters added to Ver2.03 or later.

Code	Name	Data range	Initial value	Note	Page
Hb102	Async. Motor capacity setting, 1st-motor	0.01 to 160.00 (kW) (P1-550L/P1-1320H or smaller) 0.01 to 500.00(kW) (P1-1600H or larger)	*1)		12-3-1
Hb103	Async. Motor number of poles setting, 1st-motor	0 to 23 (02 to 48 poles)	1:4P		12-3-1
Hb104	Async. Motor base frequency setting, 1st-motor	10.00 to [Hb105] (Hz)	60.00 (*FF, *FUF)/ 50.00 (*FEF, *FCF)		12-3-1
Hb105	Async. Motor maximum frequency setting, 1st-motor	[Hb104] to 590.00 (Hz)	60.00 (*FF, *FUF)/ 50.00 (*FEF, *FCF)		12-3-1
Hb106	Async. Motor rated voltage, 1st-motor	1 to 1000 (V)	200 V class: 200 (*FF)/ 230 (*FEF, *FUF,*FCF) 400V class: 400 (*FF, *FEF,*FCF)/ 460 (*FUF)		12-3-1
Hb108	Async. Motor rated current, 1st-motor	0.01 to 10000.00 (A)	*1)		12-3-1
Hb110	Async. Motor constant R1, 1st-motor	0.000001 to 1000.000000 (Ω)	*1)		12-3-4
Hb112	Async. Motor constant R2, 1st-motor	0.000001 to 1000.000000 (Ω)	*1)		12-3-4
Hb114	Async. Motor constant L, 1st-motor	0.000001 to 1000.000000 (mH)	*1)		12-3-4
Hb116	Async. Motor constant I0, 1st-motor	0.01 to 10000.00 (A)	*1)		12-3-4
Hb118	Async. Motor constant J, 1st-motor	0.00001 to 10000.00000 (kgm ²)	*1)		12-3-4
Hb130	Minimum frequency adjustment, 1st-motor	0.10 to 10.00 (Hz)	0.50		12-14-1
Hb131	Reduced voltage start time setting, 1st-motor	0 to 2000 (ms)	36		12-14-1
Hb140	Manual torque boost operation mode selection, 1st-motor	00(Disable)/ 01(Always enable)/ 02(Enable at Forward rotation)/ 03(Enable at Reverse rotation)	01		12-9-10
Hb141	Manual torque boost value, 1st-motor	0.0 to 20.0 (%)	0.0		12-9-10
Hb142	Manual torque boost peak speed, 1st-motor	0.0 to 50.0 (%)	0.0		12-9-10
Hb145	Eco drive enable, 1st-motor	00(Disable)/ 01(Enable)	00		12-9-9
Hb146	Eco drive response adjustment, 1st-motor	0 to 100	50		12-9-9
Hb150	Free-V/f frequency 1 setting, 1st-motor	0.00 to [Hb152] (Hz)	0.00		12-9-6
Hb151	Free-V/f voltage 1 setting, 1st-motor	0.0 to 1000.0 (V)	0.0		
Hb152	Free-V/f frequency 2 setting, 1st-motor	[Hb150] to [Hb154] (Hz)	0.00		
Hb153	Free-V/f voltage 2 setting, 1st-motor	0.0 to 1000.0 (V)	0.0		
Hb154	Free-V/f frequency 3 setting, 1st-motor	[Hb152] to [Hb156] (Hz)	0.00		
Hb155	Free-V/f voltage 3 setting, 1st-motor	0.0 to 1000.0 (V)	0.0		
Hb156	Free-V/f frequency 4 setting, 1st-motor	[Hb154] to [Hb158] (Hz)	0.00		
Hb157	Free-V/f voltage 4 setting, 1st-motor	0.0 to 1000.0 (V)	0.0		
Hb158	Free-V/f frequency 5 setting, 1st-motor	[Hb156] to [Hb160] (Hz)	0.00		
Hb159	Free-V/f voltage 5 setting, 1st-motor	0.0 to 1000.0 (V)	0.0		
Hb160	Free-V/f frequency 6 setting, 1st-motor	[Hb158] to [Hb162] (Hz)	0.00		
Hb161	Free-V/f voltage 6 setting, 1st-motor	0.0 to 1000.0 (V)	0.0		
Hb162	Free-V/f frequency 7 setting, 1st-motor	[Hb160] to [Hb104] (Hz)	0.00		
Hb163	Free-V/f voltage 7 setting, 1st-motor	0.0 to 1000.0 (V)	0.0		
Hb170	Slip compensation P-gain at V/f with encoder, 1st-motor	0 to 1000 (%)	100		12-9-16 to 12-9-23
Hb171	Slip compensation I-gain at V/f with encoder, 1st-motor	0 to 1000 (%)	100		12-9-16 to 12-9-23
Hb180	Output voltage gain, 1st-motor	0 to 255 (%)	100		12-9-11

*1)Varies depending on inverter models and settings of [Ub-03] Load type selection.

Code	Name	Data range	Initial value	Note	Page
Hb202	Async. Motor capacity setting, 2nd-motor	0.01 to 160.00 (kW) (P1-550L/ P1-1320H or smaller) 0.01 to 500.00(kW) (P1-1600H or larger)	*1)		
Hb203	Async. Motor number of poles setting, 2nd-motor	0 to 23 (02 to 48 poles)	1:4P		
Hb204	Async. Motor base frequency setting, 2nd-motor	10.00 to [Hb205] (Hz)	60.00 (*FF, *FUF)/ 50.00 (*FEF, *FCF)		
Hb205	Async. Motor maximum frequency setting, 2nd-motor	[Hb204] to 590.00 (Hz)	60.00 (*FF, *FUF)/ 50.00 (*FEF, *FCF)		
Hb206	Async. Motor rated voltage, 2nd-motor	1 to 1000 (V)	200 V class: 200 (*FF)/ 230 (*FEF, *FUF, *FCF) 400V class: 400 (*FF, *FEF, *FCF)/ 460 (*FUF)		
Hb208	Async. Motor rated current, 2nd-motor	0.01 to 10000.00 (A)	*1)		
Hb210	Async. Motor constant R1, 2nd-motor	0.000001 to 1000.000000 (Ω)	*1)		
Hb212	Async. Motor constant R2, 2nd-motor	0.000001 to 1000.000000 (Ω)	*1)		
Hb214	Async. Motor constant L, 2nd-motor	0.000001 to 1000.000000 (mH)	*1)		
Hb216	Async. Motor constant I0, 2nd-motor	0.01 to 10000.00 (A)	*1)		
Hb218	Async. Motor constant J, 2nd-motor	0.00001 to 10000.00000 (kgm^2)	*1)		
Hb230	Minimum frequency adjustment, 2nd-motor	0.10 to 10.00 (Hz)	0.50		
Hb231	Reduced voltage start time setting, 2nd-motor	0 to 2000 (ms)	36		
Hb240	Manual torque boost operation mode selection, 2nd-motor	00(Disable)/ 01(Always enable)/ 02(Enable at Forward rotation)/ 03(Enable at Reverse rotation)	01		
Hb241	Manual torque boost value, 2nd-motor	0.0 to 20.0 (%)	0.0		
Hb242	Manual torque boost Peak speed, 2nd-motor	0.0 to 50.0 (%)	0.0		
Hb245	Eco drive enable, 2nd-motor	00(Disable)/ 01(Enable)	00		
Hb246	Eco drive response adjustment, 2nd-motor	0 to 100	50		
Hb250	Free-V/f frequency 1 setting, 2nd-motor	0.00 to [Hb252] (Hz)	0		
Hb251	Free-V/f voltage 1 setting, 2nd-motor	0.0 to 1000.0 (V)	0.0		
Hb252	Free-V/f frequency 2 setting, 2nd-motor	[Hb250] to [Hb254] (Hz)	0.00		
Hb253	Free-V/f voltage 2 setting, 2nd-motor	0.0 to 1000.0 (V)	0.0		
Hb254	Free-V/f frequency 3 setting, 2nd-motor	[Hb252] to [Hb256] (Hz)	0.00		
Hb255	Free-V/f voltage 3 setting, 2nd-motor	0.0 to 1000.0 (V)	0.0		
Hb256	Free-V/f frequency 4 setting, 2nd-motor	[Hb254] to [Hb258] (Hz)	0.00		
Hb257	Free-V/f voltage 4 setting, 2nd-motor	0.0 to 1000.0 (V)	0.0		
Hb258	Free-V/f frequency 5 setting, 2nd-motor	[Hb256] to [Hb260] (Hz)	0.00		
Hb259	Free-V/f voltage 5 setting, 2nd-motor	0.0 to 1000.0 (V)	0.0		
Hb260	Free-V/f frequency 6 setting, 2nd-motor	[Hb258] to [Hb262] (Hz)	0.00		
Hb261	Free-V/f voltage 6 setting, 2nd-motor	0.0 to 1000.0 (V)	0.0		
Hb262	Free-V/f frequency 7 setting, 2nd-motor	[Hb260] to [Hb204] (Hz)	0.00		
Hb263	Free-V/f voltage 7 setting, 2nd-motor	0.0 to 1000.0 (V)	0.0		
Hb270	Slip compensation P-gain at V/f with encoder, 2nd-motor	0 to 1000 (%)	100		
Hb271	Slip compensation I-gain at V/f with encoder, 2nd-motor	0 to 1000 (%)	100		
Hb280	Output voltage gain, 2nd-motor	0 to 255 (%)	100		

For details,
refer to
Hb102 to
Hb180.

For the
2nd-motor
control, see
12-17-1.

*1) Varies depending on inverter models and settings of [Ub-03] Load type selection.

Code	Name	Data range	Initial value	Note	Page
HC101	Automatic torque boost voltage compensation gain, 1st-motor	0 to 255 (%)	100		12-9-7
HC102	Automatic torque boost slip compensation gain, 1st-motor	0 to 255 (%)	100		
HC110	Zero speed range limiter, 1st-motor (IM-0Hz-SLV)	0 to 100 (%)	80		12-9-14
HC111	Boost value at start, 1st-motor (IM-SLV,IM-CLV)	0 to 50 (%)	0		12-9-12 12-9-24
HC112	Boost value at start, 1st-motor (IM-0Hz-SLV)	0 to 50 (%)	10		12-9-14
HC113	Secondary resistance (R2) correction, 1st-motor	00(Disable)/ 01(Enable)	00		12-9-12 12-9-14 12-9-24
HC114	Direction reversal protection, 1st-motor	00(Disable)/ 01(Enable)	00		
HC115 *1)	Torque conversion method selection, 1st-motor	00(Torque)/ 01(Current)	00		12-11-15
HC120	Torque current reference filter time constant, 1st-motor	0 to 100 (ms)	2		12-9-12 12-9-14 12-9-24
HC121	Speed feedforward compensation gain, 1st-motor	0 to 1000 (%)	0		
HC137 *2)	Flux settling level, 1st-motor	0.0 to 100.0 (%)	80.0		21-35
HC140 *2)	Forcing level, 1st-motor	0 to 1000 (%)	100		21-35
HC141 *2)	Modulation threshold 1, 1st-motor	0 to 133 (%)	115		21-35
HC142 *2)	Modulation threshold 2, 1st-motor	0 to 133 (%)	115		21-35
HC201	Automatic torque boost voltage compensation gain, 2nd-motor	0 to 255 (%)	100		For details, refer to HC101 to HC121.
HC202	Automatic torque boost slip compensation gain, 2nd-motor	0 to 255 (%)	100		
HC210	Zero speed range limiter, 2nd-motor (IM-0Hz-SLV)	0 to 100 (%)	80		
HC211	Boost value at start, 2nd-motor (IM-SLV,IM-CLV)	0 to 50 (%)	0		
HC212	Boost value at start, 2nd-motor (IM-0Hz-SLV)	0 to 50 (%)	10		
HC213	Secondary resistor (R2) compensation enable, 2nd-motor	00(Disable)/ 01(Enable)	00		
HC214	Direction reversal protection, 2nd-motor	00(Disable)/ 01(Enable)	00		
HC215 *1)	Torque conversion method selection, 2nd-motor	00(Torque)/ 01(Current)	00		For the 2nd-motor control, see 12-17-1.
HC220	Torque current reference filter time constant, 2nd-motor	0 to 100 (ms)	2		
HC221	Speed feedforward compensation gain, 2nd-motor	0 to 1000 (%)	0		
HC237 *2)	Flux settling level, 2nd-motor	0.0 to 100.0 (%)	80.0		
HC240 *2)	Forcing level, 2nd-motor	0 to 1000 (%)	100		21-35
HC241 *2)	Modulation threshold 1, 2nd-motor	0 to 133 (%)	115		
HC242 *2)	Modulation threshold 2, 2nd-motor	0 to 133 (%)	115		

*1) [HC115]/[HC215] are the parameters added to Ver2.02 or later.

*2) These are the parameters added to Ver2.03 or later.

Code	Name	Data range	Initial value	Note	Page
Hd102	Sync. Motor capacity setting, 1st-motor	0.01 to 160.00 (kW) (P1-550L/ P1-1320H or smaller) 0.01 to 500.00 (kW) (P1-1600H or larger)	*1)		12-3-1
Hd103	Sync. Motor number of poles setting, 1st-motor	0 to 23 (02 to 48 poles)	*1)		
Hd104	Sync. Motor Base frequency setting, 1st-motor	10.00 to [Hd105] (Hz)	*1)		
Hd105	Sync. Motor Maximum frequency setting, 1st-motor	[Hd104] to 590.00 (Hz)	*1)		
Hd106	Sync. Motor rated voltage, 1st-motor	1 to 1000 (V)	*1)		
Hd108	Sync. Motor rated current, 1st-motor	0.01 to 10000.00 (A)	*1)		
Hd110	Sync. Motor constant R, 1st-motor	0.000001 to 1000.000000 (Ω)	*1)		12-3-5
Hd112	Sync. Motor constant Ld, 1st-motor	0.000001 to 1000.000000 (mH)	*1)		
Hd114	Sync. Motor constant Lq, 1st-motor	0.000001 to 1000.000000 (mH)	*1)		
Hd116	Sync. Motor constant Ke, 1st-motor	0.1 to 100000.0 (mVs/rad)	*1)		
Hd118	Sync. Motor constant J, 1st-motor	0.00001 to 10000.00000 (kgm^2)	*1)		
Hd130	Minimum frequency adjustment for Sync.M, 1st-motor	0 to 50 (%)	8		12-9-28 12-9-31
Hd131	No-Load current for Sync.M, 1st-motor	0 to 100 (%)	10		
Hd132	Starting method for Sync.M, 1st-motor	00(Synchronous)/ 01(Initial motor position estimate (IMPE))	00		
Hd133	IMPE 0V wait number for Sync.M, 1st-motor	0 to 255	10		
Hd134	IMPE detect wait number for Sync.M, 1st-motor	0 to 255	10		
Hd135	IMPE detect number for Sync.M, 1st-motor	0 to 255	30		
Hd136	IMPE voltage gain for Sync.M, 1st-motor	0 to 200 (%)	100		
Hd137	IMPE Mg-pole position offset, 1st-motor	0 to 359 (deg)	0		

*1) Varies depending on inverter models and settings of [Ub-03] Load type selection.

Code	Name	Data range	Initial value	Note	Page
Hd-41	IVMS carrier frequency	0.5 to 16.0 (kHz)	2.0		12-9-30
Hd-42	Filter gain of IVMS current detection	0 to 1000	100		
Hd-43	Open-phase voltage detection gain	00(Gain 0)/ 01(Gain 1)/ 02(Gain 2)/ 03(Gain 3)	00		
Hd-44	Open-phase switching threshold compensation	00(Disable)/ 01(Enable)	01		
Hd-45	SM(PMM)-IVMS speed control P gain	0 to 1000	100		
Hd-46	SM(PMM)-IVMS speed control I gain	0 to 10000	100		
Hd-47	SM(PMM)-IVMS wait time for open-phase switching	0 to 1000	15		
Hd-48	SM(PMM)-IVMS restriction on the rotation-direction determination	00(Disable)/ 01(Enable)	01		
Hd-49	SM(PMM)-IVMS open-phase voltage detection timing adjustment	0 to 1000	10		
Hd-50	SM(PMM)-IVMS minimum pulse width adjustment	0 to 1000	100		
Hd-51	IVMS threshold current limit	0 to 255	100		
Hd-52	IVMS threshold gain	0 to 255	100		
Hd-58	IVMS carrier-frequency switching start/finish point	0 to 50 (%)	5		

Code	Name	Data range	Initial value	Note	Page
Hd202	Sync. Motor capacity setting, 2nd-motor	0.01 to 160.00 (kW) (P1-550L/P1-1320H or smaller) 0.01 to 500.00 (kW) (P1-1600H or larger)	*1)		For details, refer to Hd102 to HC137. For the 2nd-motor control, see 12-17-1.
Hd203	Sync. Motor number of poles setting, 2nd-motor	0 to 23 (02 to 48 poles)	*1)		
Hd204	Sync. Motor Base frequency setting, 2nd-motor	10.00 to [Hd205] (Hz)	*1)		
Hd205	Sync. Motor Maximum frequency setting, 2nd-motor	[Hd204] to 590.00 (Hz)	*1)		
Hd206	Sync. Motor rated voltage, 2nd-motor	1 to 1000 (V)	*1)		
Hd208	Sync. Motor rated current, 2nd-motor	0.01 to 10000.00 (A)	*1)		
Hd210	Sync. Motor constant R, 2nd-motor	0.000001 to 1000.000000 (Ω)	*1)		
Hd212	Sync. Motor constant Ld, 2nd-motor	0.000001 to 1000.000000 (mH)	*1)		
Hd214	Sync. Motor constant Lq, 2nd-motor	0.000001 to 1000.000000 (mH)	*1)		
Hd216	Sync. Motor constant Ke, 2nd-motor	0.1 to 100000.0 (mVs/rad)	*1)		
Hd218	Sync. Motor constant J, 2nd-motor	0.00001 to 10000.00000 (kgm^2)	*1)		
Hd230	Minimum frequency adjustment for Sync.M, 2nd-motor	0 to 50 (%)	8		
Hd231	No-Load current for Sync.M, 2nd-motor	0 to 100 (%)	10		
Hd232	Starting method for Sync.M, 2nd-motor	00(Synchronous)/ 01(Initial motor position estimate (IMPE))	00		
Hd233	IMPE 0V wait number for Sync.M, 2nd-motor	0 to 255	10		
Hd234	IMPE detect wait number for Sync.M, 2nd-motor	0 to 255	10		
Hd235	IMPE detect number for Sync.M, 2nd-motor	0 to 255	30		
Hd236	IMPE voltage gain for Sync.M, 2nd-motor	0 to 200 (%)	100		
Hd237	IMPE Mg-pole position offset, 2nd-motor	0 to 359 (deg)	0		

*1) Varies depending on inverter models and settings of [Ub-03] "Load type selection".

■ Parameter mode (code o).

Code	Name	Data range	Initial value	Note	Page
oA-10	Operation selection at an option error (SLOT-1)	00(Error)/ 01(Ignore error (keep running))	00		15-2 *1)
oA-11	Communication Watch Dog Timer (SLOT-1)	0.00 to 100.00 (s)	1.00		15-4 *1)
oA-12	Action selection at a communication error (SLOT-1)	00(Error)/ 01(Trip after Deceleration stop)/ 02(Ignore)/ 03(Free run stop)/ 04(Deceleration stop)	01		15-4 *1)
oA-13	RUN command selection at start up (SLOT-1)	00(Disable)/ 01(Enable)	00		15-2 *1)
oA-20	Operation selection at an option error (SLOT-2)	00(Error)/ 01(Ignore error (keep running))	00		15-2 *1)
oA-21	Communication Watch Dog Timer (SLOT-2)	0.00 to 100.00 (s)	1.00		15-4 *1)
oA-22	Action selection at a communication error (SLOT-2)	00(Error)/ 01(Trip after Deceleration stop)/ 02(Ignore)/ 03(Free run stop)/ 04(Deceleration stop)	01		15-4 *1)
oA-23	RUN command selection at start up (SLOT-2)	00(Disable)/ 01(Enable)	00		15-2 *1)
oA-30	Operation selection at an option error (SLOT-3)	00(Error)/ 01(Ignore error (keep running))	00		15-2 *1)
oA-31	Communication Watch Dog Timer (SLOT-3)	0.00 to 100.00 (s)	1.00		15-4 *1)
oA-32	Action selection at a communication error (SLOT-3)	00(Error)/ 01(Trip after Deceleration stop)/ 02(Ignore)/ 03(Free run stop)/ 04(Deceleration stop)	01		15-4 *1)
oA-33	RUN command selection at start up (SLOT-3)	00(Disable)/ 01(Enable)	00		15-2 *1)

Code	Name	Data range	Initial value	Note	Page
ob-01	Encoder constant setting (option)	32 to 65535 (pls)	1024		12-9-35 *1)
ob-02	Encoder phase sequence selection (option)	00(Phase-A Lead)/ 01(Phase-B Lead)	00		
ob-03	Motor gear ratio numerator (option)	1 to 10000	1		
ob-04	Motor gear ratio denominator (option)	1 to 10000	1		
ob-10	Pulse train input, target function selection (option)	00(Frequency reference)/ 01(Pulse train position reference)	00		12-4-7 *1)
ob-11	Pulse train input mode selection (option)	00(90° shift pulse train)/ 01(Forward/ Reverse pulse train and direction signal)/ 02(Forward pulse train and Reverse pulse train)	01		
ob-12	Pulse train frequency scale (option)	0.05 to 200.00 (kHz)	25.00		
ob-13	Pulse train frequency filter time constant (option)	0.01 to 2.00 (s)	0.10		
ob-14	Pulse train frequency bias value (option)	-100.0 to 100.0 (%)	0.0		
ob-15	Pulse train upper frequency detection level(option)	0 to 100.0 (%)	100.0		
ob-16	Pulse train lower frequency detection level (option)	0 to 100.0 (%)	0.0		

*1) For details, refer to the each option's Guide.

Code	Name	Data range	Initial value	Note	Page
oC-01	Safety option input display selection	00(Warning: with display)/ 01(Warning: without display)	00		15-7 *1)
oC-10	SS1-A deceleration time setting	0.00 to 3600.00 (s)	30.00		
oC-12	SLS-A deceleration time setting	0.00 to 3600.00 (s)	30.00		
oC-14	SLS-A speed upper limit (Forward)	0.00 to 590.00 (Hz)	0.00		
oC-15	SLS-A speed upper limit (Reverse)	0.00 to 590.00 (Hz)	0.00		
oC-16	SDI-A deceleration time setting	0.00 to 3600.00 (s)	30.00		
oC-18	SDI-A direction limit mode	00(Limit)/ 01(Invert)	00		
oC-20	SS1-B deceleration time setting	0.00 to 3600.00 (s)	30.00		
oC-22	SLS-B deceleration time setting	0.00 to 3600.00 (s)	30.00		
oC-24	SLS-B speed upper limit (Forward)	0.00 to 590.00 (Hz)	0.00		
oC-25	SLS-B speed upper limit (Reverse)	0.00 to 590.00 (Hz)	0.00		
oC-26	SDI-B deceleration time setting	0.00 to 3600.00 (s)	30.00		
oC-28	SDI-B direction limit mode	00(Limit)/ 01(Invert)	00		

Code	Name	Data range	Initial value	Note	Page
oE-01	[Ai4] Filter time constant	1 to 500 (ms)	16		12-24-14 *1)
oE-03	[Ai4] Start value	0.00 to 100.00 (%)	0.00		
oE-04	[Ai4] End value	0.00 to 100.00 (%)	100.00		
oE-05	[Ai4] Start rate	0.0 to [oE-06] (%)	0.0		
oE-06	[Ai4] End rate	[oE-05] to 100.0 (%)	100.0		
oE-07	[Ai4] Start point selection	00(Start value[oE-03])/ 01(0%)	01		
oE-11	[Ai5] Filter time constant	1 to 500 (ms)	16		
oE-13	[Ai5] Start value	0.00 to 100.00 (%)	0.00		
oE-14	[Ai5] End value	0.00 to 100.00 (%)	100.00		
oE-15	[Ai5] Start rate	0.0 to [oE-16] (%)	0.0		
oE-16	[Ai5] End rate	[oE-15] to 100.0 (%)	100.0		
oE-17	[Ai5] Start point selection	00(Start value[oE-13])/ 01(0%)	01		
oE-21	[Ai6] Filter time constant	1 to 500 (ms)	16		
oE-23	[Ai6] Start value	-100.00 to 100.00 (%)	-100.00		
oE-24	[Ai6] End value	-100.00 to 100.00 (%)	100.00		
oE-25	[Ai6] Start rate	-100.0 to [oE-26] (%)	-100.0		
oE-26	[Ai6] End rate	[oE-25] to 100.0 (%)	100.0		
oE-28	[Ai4] Voltage/Current bias adjustment	-100.00 to 100.00 (%)	0.00		
oE-29	[Ai4] Voltage/Current gain adjustment	0- 200.00 (%)	100.00		
oE-30	[Ai5] Voltage/Current bias adjustment	-100.00 to 100.00 (%)	0.00		
oE-31	[Ai5] Voltage/Current gain adjustment	0 to 200.00 (%)	100.00		
oE-32	[Ai6] Voltage bias adjustment	-100.00 to 100.00 (%)	0.00		
oE-33	[Ai6] Voltage gain adjustment	0 to 200.00 (%)	100.00		

*1) For details, refer to the each option's Guide.

Code	Name	Data range	Initial value	Note	Page
oE-35	[Ai4] Window comparator upper limit	0 to 100 (%)	100		12-24-14 *1)
oE-36	[Ai4] Window comparator lower limit	0 to 100 (%)	0		
oE-37	[Ai4] Window comparator hysteresis width	0 to 10 (%)	0		
oE-38	[Ai5] Window comparator upper limit	0 to 100 (%)	100		
oE-39	[Ai5] Window comparator lower limit	0 to 100 (%)	0		
oE-40	[Ai5] Window comparator hysteresis width	0 to 10 (%)	0		
oE-41	[Ai6] Window comparator upper limit	-100 to 100 (%)	100		
oE-42	[Ai6] Window comparator lower limit	-100 to 100 (%)	-100		
oE-43	[Ai6] Window comparator hysteresis width	0 to 10 (%)	0		
oE-44	[Ai4] Temporal operation level set at disconnection or compare event	0 to 100 (%)	0		
oE-45	[Ai4] Temporal operation level implementation timing	00(Disable)/ 01(Enable(at WC*active))/ 02(Enable(at WC*de-active))	00		
oE-46	[Ai5] Temporal operation level set at disconnection or compare event	0 to 100 (%)	0		
oE-47	[Ai5] Temporal operation level implementation timing	00(Disable)/ 01(Enable(at WC*active))/ 02(Enable(at WC*de-active))	00		
oE-48	[Ai6] Temporal operation level set at disconnection or compare event	-100 to 100 (%)	0		
oE-49	[Ai6] Temporal operation level implementation timing	00(Disable)/ 01(Enable(at WC*active))/ 02(Enable(at WC*de-active))	00		
oE-50	[Ao3] Output monitor selection	See <List of output monitor functions>	dA-01		12-25-16 *1)
oE-51	[Ao4] Output monitor selection	See <List of output monitor functions>	dA-01		
oE-52	[Ao5] Output monitor selection	See <List of output monitor functions>	dA-01		
oE-56	[Ao3] Output filter time constant	1 to 500 (ms)	100		
oE-57	[Ao3] Data type selection	00(Absolute value)/ 01(Signed value)	00		
oE-58	[Ao3] Bias adjustment	-100.0 to 100.0 (%)	0.0		
oE-59	[Ao3] Gain adjustment	-1000.0 to 1000.0 (%)	100.0		
oE-60	Adjustment mode [Ao3] output level	-100.0 to 100.0 (%)	100.0		
oE-61	[Ao4] Output filter time constant	1 to 500 (ms)	100		
oE-62	[Ao4] Data type selection	00(Absolute value)/ 01(Signed value)	00		
oE-63	[Ao4] Bias adjustment	-100.0 to 100.0 (%)	0.0		
oE-64	[Ao4] Gain adjustment	-1000.0 to 1000.0 (%)	100.0		
oE-65	Adjustment mode [Ao4] output level	-100.0 to 100.0 (%)	100.0		
oE-66	[Ao5] Output filter time constant	1 to 500 (ms)	100		
oE-67	[Ao5] Data type selection	00(Absolute value)/ 01(Signed value)	00		
oE-68	[Ao5] Bias adjustment	-100.0 to 100.0 (%)	0.0		
oE-69	[Ao5] Gain adjustment	-1000.0 to 1000.0 (%)	100.0		
oE-70	Adjustment mode [Ao5] output level	-100.0 to 100.0 (%)	100.0		

*1) For details, refer to the each option's Guide.

Code	Name	Data range	Initial value	Note	Page
oH-01	IP address selection (P1-EN)	00(Group 1)/ 01(Group 2)	00		15-5 *1)
oH-02	Communication speed (port-1) (P1-EN)	00(Auto Negotiation)/ 01(100M:full duplex)/ 02(100M:half duplex)/	00		
oH-03	Communication speed (port-2) (P1-EN)	03(10M:full duplex)/ 04(10M:half duplex)	00		
oH-04	Ethernet communication timeout (P1-EN)	1 to 65535 (× 10ms)	3000		
oH-05	Modbus TCP Port No.(IPv4) (P1-EN)	502, 1024 to 65535	502		
oH-06	Modbus TCP Port No.(IPv6) (P1-EN)	502, 1024 to 65535	502		
oH-20	PROFIBUS Nobe address (P1-PB)	0 to 125	0		
oH-21	Profibus Clear Mode selection (P1-PB)	(For factory setting. Do not change.)	00		
oH-22	Profibus Map selection (P1-PB)		00		
oH-23	Profibus master setting selection (P1-PB)		00		
oH-24	PROFIBUS Telegram group selection (P1-PB)	00 (Gr.A)/01 (Gr.B)/02 (Gr.C)	00		
oH-30	PN IP address selection (P1-PN)	(For factory setting. Do not change.)	00		
oH-31	PN Communication speed (port-1) (P1-PN)		00		
oH-32	PN Communication speed (port-2) (P1-PN)		00		
oH-33	PN Ethernet communication timeout (P1-PN)		3000		
oH-34	PROFINRT Telegram group selection (P1-PN)	00 (Gr.A)/01 (Gr.B)/02 (Gr.C)	00		
oH-40	DeviceNet node address (MAC ID) (P1-DN)	0 to 63	0		
oH-41	DeviceNet assembly instance number selection (P1-DN)	00(Instance 20 and 70)/ 01(Instance 21 and 71)/ 02(Instance 100 and 150)/ 03(Instance 101 and 151)/ 04(Instance 101 and 153)/ 05(Instance 110 and 111)/ 06(Instance 123 and 173)/ 07(Instance 139 and 159)	00		
oH-42	DeviceNet speed unit selection (P1-DN)	00(Hz)/ 01(min-1)	01		
oH-44	DeviceNet flexible Gr. format selection (P1-DN)	00(Gr. A)/ 01(Gr. B)/ 02(Gr. C)	00		
oH-45	DeviceNet idle mode action selection (P1-DN)	00(Trip)/ 01(Decel-Trip)/ 02(Ignore)/ 03(Free Run Stop)/ 04(Decel Stop)	00		

*1) For details, refer to the each option's Guide.

Code	Name	Data range	Initial value	Note	Page
oJ-01	Writing register 1, Gr.A	0000 to FFFF	0000		15-5 *1)
oJ-02	Writing register 2, Gr.A	0000 to FFFF	0000		
oJ-03	Writing register 3, Gr.A	0000 to FFFF	0000		
oJ-04	Writing register 4, Gr.A	0000 to FFFF	0000		
oJ-05	Writing register 5, Gr.A	0000 to FFFF	0000		
oJ-06	Writing register 6, Gr.A	0000 to FFFF	0000		
oJ-07	Writing register 7, Gr.A	0000 to FFFF	0000		
oJ-08	Writing register 8, Gr.A	0000 to FFFF	0000		
oJ-09	Writing register 9, Gr.A	0000 to FFFF	0000		
oJ-10	Writing register 10, Gr.A	0000 to FFFF	0000		
oJ-11	Reading register 1 Gr.A	0000 to FFFF	0000		
oJ-12	Reading register 2 Gr.A	0000 to FFFF	0000		
oJ-13	Reading register 3 Gr.A	0000 to FFFF	0000		
oJ-14	Reading register 4 Gr.A	0000 to FFFF	0000		
oJ-15	Reading register 5 Gr.A	0000 to FFFF	0000		
oJ-16	Reading register 6 Gr.A	0000 to FFFF	0000		
oJ-17	Reading register 7 Gr.A	0000 to FFFF	0000		
oJ-18	Reading register 8 Gr.A	0000 to FFFF	0000		
oJ-19	Reading register 9 Gr.A	0000 to FFFF	0000		
oJ-20	Reading register 10 Gr.A	0000 to FFFF	0000		
oJ-21	Writing register 1, Gr.B	0000 to FFFF	0000		
oJ-22	Writing register 2, Gr.B	0000 to FFFF	0000		
oJ-23	Writing register 3, Gr.B	0000 to FFFF	0000		
oJ-24	Writing register 4, Gr.B	0000 to FFFF	0000		
oJ-25	Writing register 5, Gr.B	0000 to FFFF	0000		
oJ-26	Writing register 6, Gr.B	0000 to FFFF	0000		
oJ-27	Writing register 7, Gr.B	0000 to FFFF	0000		
oJ-28	Writing register 8, Gr.B	0000 to FFFF	0000		
oJ-29	Writing register 9, Gr.B	0000 to FFFF	0000		
oJ-30	Writing register 10, Gr.B	0000 to FFFF	0000		
oJ-31	Reading register 1 Gr.B	0000 to FFFF	0000		
oJ-32	Reading register 2 Gr.B	0000 to FFFF	0000		
oJ-33	Reading register 3 Gr.B	0000 to FFFF	0000		
oJ-34	Reading register 4 Gr.B	0000 to FFFF	0000		
oJ-35	Reading register 5 Gr.B	0000 to FFFF	0000		
oJ-36	Reading register 6 Gr.B	0000 to FFFF	0000		
oJ-37	Reading register 7 Gr.B	0000 to FFFF	0000		
oJ-38	Reading register 8 Gr.B	0000 to FFFF	0000		
oJ-39	Reading register 9 Gr.B	0000 to FFFF	0000		
oJ-40	Reading register 10 Gr.B	0000 to FFFF	0000		

*1) For details, refer to the each option's Guide.

Code	Name	Data range	Initial value	Note	Page
oJ-41	Writing register 1, Gr.C	0000 to FFFF	0000		15-5 *1)
oJ-42	Writing register 2, Gr.C	0000 to FFFF	0000		
oJ-43	Writing register 3, Gr.C	0000 to FFFF	0000		
oJ-44	Writing register 4, Gr.C	0000 to FFFF	0000		
oJ-45	Writing register 5, Gr.C	0000 to FFFF	0000		
oJ-46	Writing register 6, Gr.C	0000 to FFFF	0000		
oJ-47	Writing register 7, Gr.C	0000 to FFFF	0000		
oJ-48	Writing register 8, Gr.C	0000 to FFFF	0000		
oJ-49	Writing register 9, Gr.C	0000 to FFFF	0000		
oJ-50	Writing register 10, Gr.C	0000 to FFFF	0000		
oJ-51	Reading register 1 Gr.C	0000 to FFFF	0000		
oJ-52	Reading register 2 Gr.C	0000 to FFFF	0000		
oJ-53	Reading register 3 Gr.C	0000 to FFFF	0000		
oJ-54	Reading register 4 Gr.C	0000 to FFFF	0000		
oJ-55	Reading register 5 Gr.C	0000 to FFFF	0000		
oJ-56	Reading register 6 Gr.C	0000 to FFFF	0000		
oJ-57	Reading register 7 Gr.C	0000 to FFFF	0000		
oJ-58	Reading register 8 Gr.C	0000 to FFFF	0000		
oJ-59	Reading register 9 Gr.C	0000 to FFFF	0000		
oJ-60	Reading register 10 Gr.C	0000 to FFFF	0000		

*1) For details, refer to the each option's Guide.

Code	Name	Data range	Initial value	Note	Page
oL-01	IPv4 IP address (1) Gr.1	0 to 255	192		15-5 *1)
oL-02	IPv4 IP address (2) Gr.1	0 to 255	168		
oL-03	IPv4 IP address (3) Gr.1	0 to 255	0		
oL-04	IPv4 IP address (4) Gr.1	0 to 255	2		
oL-05	IPv4 subnet mask (1) Gr.1	0 to 255	255		
oL-06	IPv4 subnet mask (2) Gr.1	0 to 255	255		
oL-07	IPv4 subnet mask (3) Gr.1	0 to 255	255		
oL-08	IPv4 subnet mask (4) Gr.1	0 to 255	0		
oL-09	IPv4 default gateway (1) Gr.1	0 to 255	192		
oL-10	IPv4 default gateway (2) Gr.1	0 to 255	168		
oL-11	IPv4 default gateway (3) Gr.1	0 to 255	0		
oL-12	IPv4 default gateway (4) Gr.1	0 to 255	1		
oL-20	IPv6 IP address (1) Gr.1	0000 to FFFF	0000		
oL-21	IPv6 IP address (2) Gr.1	0000 to FFFF	0000		
oL-22	IPv6 IP address (3) Gr.1	0000 to FFFF	0000		
oL-23	IPv6 IP address (4) Gr.1	0000 to FFFF	0000		
oL-24	IPv6 IP address (5) Gr.1	0000 to FFFF	0000		
oL-25	IPv6 IP address (6) Gr.1	0000 to FFFF	0000		
oL-26	IPv6 IP address (7) Gr.1	0000 to FFFF	0000		
oL-27	IPv6 IP address (8) Gr.1	0000 to FFFF	0000		
oL-28	IPv6 Prefix of subnet, Gr.1	0 to 127	64		
oL-29	IPv6 default gateway (1) Gr.1	0000 to FFFF	0000		
oL-30	IPv6 default gateway (2) Gr.1	0000 to FFFF	0000		
oL-31	IPv6 default gateway (3) Gr.1	0000 to FFFF	0000		
oL-32	IPv6 default gateway (4) Gr.1	0000 to FFFF	0000		
oL-33	IPv6 default gateway (5) Gr.1	0000 to FFFF	0000		
oL-34	IPv6 default gateway (6) Gr.1	0000 to FFFF	0000		
oL-35	IPv6 default gateway (7) Gr.1	0000 to FFFF	0000		
oL-36	IPv6 default gateway (8) Gr.1	0000 to FFFF	0000		

*1) For details, refer to the each option's Guide.

Code	Name	Data range	Initial value	Note	Page
oL-40	IPv4 IP-address (1) Gr.2	0 to 255	192		15-5 *1)
oL-41	IPv4 IP-address (2) Gr.2	0 to 255	168		
oL-42	IPv4 IP-address (3) Gr.2	0 to 255	0		
oL-43	IPv4 IP-address (4) Gr.2	0 to 255	2		
oL-44	IPv4 subnet mask (1) Gr.2	0 to 255	255		
oL-45	IPv4 subnet mask (2) Gr.2	0 to 255	255		
oL-46	IPv4 subnet mask (3) Gr.2	0 to 255	255		
oL-47	IPv4 subnet mask (4) Gr.2	0 to 255	0		
oL-48	IPv4 default gateway (1) Gr.2	0 to 255	192		
oL-49	IPv4 default gateway (2) Gr.2	0 to 255	168		
oL-50	IPv4 default gateway (3) Gr.2	0 to 255	0		
oL-51	IPv4 default gateway (4) Gr.2	0 to 255	1		
oL-60	IPv6 IP address (1) Gr.2	0000 to FFFF	0000		
oL-61	IPv6 IP address (2) Gr.2	0000 to FFFF	0000		
oL-62	IPv6 IP address (3) Gr.2	0000 to FFFF	0000		
oL-63	IPv6 IP address (4) Gr.2	0000 to FFFF	0000		
oL-64	IPv6 IP address (5) Gr.2	0000 to FFFF	0000		
oL-65	IPv6 IP address (6) Gr.2	0000 to FFFF	0000		
oL-66	IPv6 IP address (7) Gr.2	0000 to FFFF	0000		
oL-67	IPv6 IP address (8) Gr.2	0000 to FFFF	0000		
oL-68	IPv6 Prefix of subnet, Gr.2	0 to 127	64		
oL-69	IPv6 default gateway (1) Gr.2	0000 to FFFF	0000		
oL-70	IPv6 default gateway (2) Gr.2	0000 to FFFF	0000		
oL-71	IPv6 default gateway (3) Gr.2	0000 to FFFF	0000		
oL-72	IPv6 default gateway (4) Gr.2	0000 to FFFF	0000		
oL-73	IPv6 default gateway (5) Gr.2	0000 to FFFF	0000		
oL-74	IPv6 default gateway (6) Gr.2	0000 to FFFF	0000		
oL-75	IPv6 default gateway (7) Gr.2	0000 to FFFF	0000		
oL-76	IPv6 default gateway (8) Gr.2	0000 to FFFF	0000		

*1) For details, refer to the each option's Guide.

■ Parameter mode (code P).

Code	Name	Data range	Initial value	Note	Page
PA-01	Enable Emergency-force drive mode	00(Disable)/ 01(Enable)	00		12-17-13
PA-02	Emergency-force drive frequency reference	0.00 to 590.00 (Hz)	0.00		
PA-03	Emergency-force drive direction command	00(Forward)/ 01(Reverse)	00		
PA-04	Commercial power supply bypass function selection	00(Disable)/ 01(Enable)	00		12-17-15
PA-05	Commercial power supply bypass function delay time	0.0 to 1000.0 (s)	5.0		

Code	Name	Data range	Initial value	Note	Page
PA-20	Simulation mode enable	00(Disable)/ 01(Enable)	00		10-9
PA-21	Error code selection for alarm test	0 to 255 (Error code)	0		
PA-22	Simulation mode: Optional output selection for the output current monitor	00(Disable)/ 01(Parameter[PA-23])/ 02(Setting by Terminal[Ai1])/ 03(Setting by Terminal[Ai2])/ 04(Setting by Terminal[Ai3])/ 05(Setting by Terminal[Ai4])/ 06(Setting by Terminal[Ai5])/ 07(Setting by Terminal[Ai6])	01		
PA-23	Optional output value setting for the output current monitor	(0 to 3.0)×Inverter rated current (A)	0.0		
PA-24	Simulation mode: Optional output selection for the DC bus voltage monitor	00(Disable)/ 01(Parameter[PA-25])/ 02(Setting by Terminal[Ai1])/ 03(Setting by Terminal[Ai2])/ 04(Setting by Terminal[Ai3])/ 05(Setting by Terminal[Ai4])/ 06(Setting by Terminal[Ai5])/ 07(Setting by Terminal[Ai6])	01		
PA-25	Optional output value setting for the DC bus voltage monitor	0.0 to 450.0 (VDC) (200V class) 0.0 to 900.0 (VDC) (400V class)	200V class 270.0 400V class 540.0		
PA-26	Simulation mode: Optional output selection for the output voltage monitor	00(Disable)/ 01(Parameter[PA-27])/ 02(Setting by Terminal[Ai1])/ 03(Setting by Terminal[Ai2])/ 04(Setting by Terminal[Ai3])/ 05(Setting by Terminal[Ai4])/ 06(Setting by Terminal[Ai5])/ 07(Setting by Terminal[Ai6])	01		
PA-27	Optional output value setting for the output voltage monitor	0.0 to 300.0 (V) (200V class) 0.0 to 600.0 (V) (400V class)	0.0		
PA-28	Simulation mode: Optional output selection for the output torque monitor	00(Disable)/ 01(Parameter[PA-29])/ 02(Setting by Terminal[Ai1])/ 03(Setting by Terminal[Ai2])/ 04(Setting by Terminal[Ai3])/ 05(Setting by Terminal[Ai4])/ 06(Setting by Terminal[Ai5])/ 07(Setting by Terminal[Ai6])	01		
PA-29	Optional output value setting for the output torque monitor	-500.0 to +500.0 (%)	0.0		
PA-30	Simulation mode: Optional frequency matching start enable setting	00(Disable)/ 01(Parameter[PA-31])/ 02(Setting by Terminal[Ai1])/ 03(Setting by Terminal[Ai2])/ 04(Setting by Terminal[Ai3])/ 05(Setting by Terminal[Ai4])/ 06(Setting by Terminal[Ai5])/ 07(Setting by Terminal[Ai6])	01		
PA-31	Optional frequency matching start setting value	0.00 to 590.00 (Hz)	0.00		

■ Parameter mode (code U).

Code	Name	Data range	Initial value	Note	Page
UA-01	Password for display (UA-10)	0000 to FFFF	0000		9-34
UA-02	Password for softlock (UA-16)	0000 to FFFF	0000		9-34
UA-10	Display restriction selection	00(Full display)/ 01(Function-specific display)/ 02(User setting display)/ 03(Data comparison display)/ 04(Monitor only)	00		9-34
UA-12	Accumulated input power monitor clear	00(Disable)/ 01(Clear)	00		13-14
UA-13	Display gain for the accumulated input power monitor	1 to 1000	1		13-14
UA-14	Accumulated output power monitor clear	00(Disable)/ 01(Clear)	00		13-15
UA-15	Display gain for the accumulated output power monitor	1 to 1000	1		13-15
UA-16	Soft-Lock selection	00([SFT] terminal)/ 01(Always enable)	00		9-24
UA-17	Soft-Lock target selection	00(All data)/ 01(All, except speed related values)	00		9-24
UA-18	Data R/W selection	00(Enable R/W by operator)/ 01(Disable R/W by operator)	00		9-42
UA-19	Low battery warning enable	00(Disable)/ 01(Warning[LBK])/ 02(Error[E042])	00		9-41
UA-20	Action selection at keypad disconnection	00(Error)/ 01(Error output after deceleration stop)/ 02(Ignore)/ 03(Free run stop)/ 04(Deceleration stop)	02		9-40
UA-21	2nd-motor parameter display selection	00(Hidden)/ 01(Display)	01		9-25
UA-22	Option parameter display selection	00(Hidden)/ 01(Display)	01		9-25
UA-30	User-parameter auto setting function enable	00(Disable)/ 01(Enable)	00		9-33
UA-31	User-parameter 1 selection	no/****(select a parameter)	no		9-33
UA-32	User-parameter 2 selection	no/****(select a parameter)	no		9-33
UA-33	User-parameter 3 selection	no/****(select a parameter)	no		9-33
UA-34	User-parameter 4 selection	no/****(select a parameter)	no		9-33
UA-35	User-parameter 5 selection	no/****(select a parameter)	no		9-33
UA-36	User-parameter 6 selection	no/****(select a parameter)	no		9-33
UA-37	User-parameter 7 selection	no/****(select a parameter)	no		9-33
UA-38	User-parameter 8 selection	no/****(select a parameter)	no		9-33
UA-39	User-parameter 9 selection	no/****(select a parameter)	no		9-33
UA-40	User-parameter 10 selection	no/****(select a parameter)	no		9-33
UA-41	User-parameter 11 selection	no/****(select a parameter)	no		9-33
UA-42	User-parameter 12 selection	no/****(select a parameter)	no		9-33
UA-43	User-parameter 13 selection	no/****(select a parameter)	no		9-33
UA-44	User-parameter 14 selection	no/****(select a parameter)	no		9-33
UA-45	User-parameter 15 selection	no/****(select a parameter)	no		9-33
UA-46	User-parameter 16 selection	no/****(select a parameter)	no		9-33
UA-47	User-parameter 17 selection	no/****(select a parameter)	no		9-33
UA-48	User-parameter 18 selection	no/****(select a parameter)	no		9-33
UA-49	User-parameter 19 selection	no/****(select a parameter)	no		9-33
UA-50	User-parameter 20 selection	no/****(select a parameter)	no		9-33
UA-51	User-parameter 21 selection	no/****(select a parameter)	no		9-33
UA-52	User-parameter 22 selection	no/****(select a parameter)	no		9-33
UA-53	User-parameter 23 selection	no/****(select a parameter)	no		9-33
UA-54	User-parameter 24 selection	no/****(select a parameter)	no		9-33
UA-55	User-parameter 25 selection	no/****(select a parameter)	no		9-33
UA-56	User-parameter 26 selection	no/****(select a parameter)	no		9-33
UA-57	User-parameter 27 selection	no/****(select a parameter)	no		9-33
UA-58	User-parameter 28 selection	no/****(select a parameter)	no		9-33
UA-59	User-parameter 29 selection	no/****(select a parameter)	no		9-33
UA-60	User-parameter 30 selection	no/****(select a parameter)	no		9-33
UA-61	User-parameter 31 selection	no/****(select a parameter)	no		9-33
UA-62	User-parameter 32 selection	no/****(select a parameter)	no		9-33

Code	Name	Data range	Initial value	Note	Page
UA-90	Waiting time for turning off the display(MOP)	0 to 60 (min)	0		-
UA-91	Initial display selection (MOP)	d*-/FA-* (select a monitor parameter)	dA-01		-
UA-92	Enable auto-return to the initial display (MOP)	00(Disable)/ 01(Enable)	00		-
UA-93	Enable frequency changes through monitor display(MOP)	00(Disable)/ 01(Enable)	00		-
UA-94	Enable multispeed frequency changes through monitor display (MOP)	00(Disable)/ 01(Enable)	00		-

Code	Name	Data range	Initial value	Note	Page
Ub-01	Initialize mode selection	00(Disable)/ 01(Error history clear)/ 02(Data initialize)/ 03(Error history clear & Data initialize)/ 04(Error history clear & Data initialize & EzSQ clear)/ 05(All data except terminal configuration)/ 06(All data except communication configuration)/ 07(All data except terminal & communication configuration)/ 08(EzSQ only)	00		12-2-3
Ub-02	Initialize data selection	00(JP)/ 01(EU)/ 02(USA)/ 03(CHINA)	00 (*FF)/ 01 (*FEF)/ 02 (*FUF)/ 03 (*FCF)/		12-2-3
Ub-03	Load type selection	00(Very Low Duty)/ 01(Low Duty)/ 02(Normal Duty)	02		12-2-1
Ub-05	Enable initialization	00(Disable)/ 01(Execute initialization)	00		12-2-3

Code	Name	Data range	Initial value	Note	Page
<u>UC-01</u>	Debug mode selection	(For factory setting. Do not change.)	00	-	-

Code	Name	Data range	Initial value	Note	Page
Ud-01	Trace function enable	00(Disabled)/ 01(Enabled)	00		16-8
Ud-02	Trace start	00(Stop)/ 01(Start)	00		
Ud-03	Number of trace data setting	0 to 8	1		
Ud-04	Number of trace signals setting	0 to 8	1		
Ud-10	Trace data 0 selection	See <List of output monitor functions> in Appendix 1-40	dA-01		
Ud-11	Trace data 1 selection		dA-01		
Ud-12	Trace data 2 selection		dA-01		
Ud-13	Trace data 3 selection		dA-01		
Ud-14	Trace data 4 selection		dA-01		
Ud-15	Trace data 5 selection		dA-01		
Ud-16	Trace data 6 selection		dA-01		
Ud-17	Trace data 7 selection		dA-01		
Ud-20	Trace signal 0 input/output selection	00 (Input: [Ud-21])/ 01 (Output: [Ud-22])	00		
Ud-21	Trace signal 0 input terminal selection	*1)	001		
Ud-22	Trace signal 0 output terminal selection	*2)	001		
Ud-23	Trace signal 1 input/output selection	00 (Input: [Ud-24])/ 01 (Output: [Ud-25])	00		
Ud-24	Trace signal 1 input terminal selection	*1)	001		
Ud-25	Trace signal 1 output terminal selection	*2)	001		
Ud-26	Trace signal 2 input/output selection	00 (Input: [Ud-27])/ 01 (Output: [Ud-28])	00		
Ud-27	Trace signal 2 input terminal selection	*1)	001		
Ud-28	Trace signal 2 output terminal selection	*2)	001		
Ud-29	Trace signal 3 input/output selection	00 (Input: [Ud-30])/ 01 (Output: [Ud-31])	00		
Ud-30	Trace signal 3 input terminal selection	*1)	001		
Ud-31	Trace signal 3 output terminal selection	*2)	001		
Ud-32	Trace signal 4 input/output selection	00 (Input: [Ud-33])/ 01 (Output: [Ud-34])	00		
Ud-33	Trace signal 4 input terminal selection	*1)	001		
Ud-34	Trace signal 4 output terminal selection	*2)	001		
Ud-35	Trace signal 5 input/output selection	00 (Input: [Ud-36])/ 01 (Output: [Ud-37])	00		
Ud-36	Trace signal 5 input terminal selection	*1)	001		
Ud-37	Trace signal 5 output terminal selection	*2)	001		
Ud-38	Trace signal 6 input/output selection	00 (Input: [Ud-39])/ 01 (Output: [Ud-40])	00		
Ud-39	Trace signal 6 input terminal selection	*1)	001		
Ud-40	Trace signal 6 output terminal selection	*2)	001		
Ud-41	Trace signal 7 input/output selection	00 (Input: [Ud-42])/ 01 (Output: [Ud-43])	00		
Ud-42	Trace signal 7 input terminal selection	*1)	001		
Ud-43	Trace signal 7 output terminal selection	*2)	001		

*1) See <List of input terminal functions> in Appendix 1-32.

*2) See <List of output terminal functions> in Appendix 1-37.

Code	Name	Data range	Initial value	Note	Page
Ud-50	Trace trigger 1 selection	00(Trip)/ 01(Trace data 0)/ 02(Trace data 1)/ 03(Trace data 2)/ 04(Trace data 3)/ 05(Trace data 4)/ 06(Trace data 5)/ 07(Trace data 6)/ 08(Trace data 7)/ 09(Trace signal 0)/ 10(Trace signal 1)/ 11(Trace signal 2)/ 12(Trace signal 3)/ 13(Trace signal 4)/ 14(Trace signal 5)/ 15(Trace signal 6)/ 16(Trace signal 7)	00		16-8
Ud-51	Trigger 1 activation selection at trace data trigger	00(Action at rising above the trigger level)/ 01(Action at falling below the trigger level)	00		
Ud-52	Trigger 1 level setting at trace data trigger	0 to 100 (%)	0		
Ud-53	Trigger 1 activation selection at trace signal trigger	00(Action by signal on)/ 01(Action by signal off)	00		
Ud-54	Trace trigger 2 selection	00(Trip)/ 01(Trace data 0)/ 02(Trace data 1)/ 03(Trace data 2)/ 04(Trace data 3)/ 05(Trace data 4)/ 06(Trace data 5)/ 07(Trace data 6)/ 08(Trace data 7)/ 09(Trace signal 0)/ 10(Trace signal 1)/ 11(Trace signal 2)/ 12(Trace signal 3)/ 13(Trace signal 4)/ 14(Trace signal 5)/ 15(Trace signal 6)/ 16(Trace signal 7)	00		
Ud-55	Trigger 2 activation selection at trace data trigger	00(Action at rising above the trigger level)/ 01(Action at falling below the trigger level)	00		
Ud-56	Trigger 2 level setting at trace data trigger	0 to 100 (%)	0		
Ud-57	Trigger 2 activation selection at trace signal trigger	00(Action by signal on)/ 01(Action by signal off)	00		
Ud-58	Trigger condition selection	00(At trace trigger 1 activation)/ 01(At trace trigger 2 activation)/ 02(Trigger-1 OR trigger-2 activation)/ 03(Trigger-1 AND trigger-2 activation)	00		
Ud-59	Trigger point setting	0 to 100 (%)	0		
Ud-60	Sampling time setting	01(0.2ms)/ 02(0.5ms)/ 03(1ms)/ 04(2ms)/ 05(5ms)/ 06(10ms)/ 07(50ms)/ 08(100ms)/ 09(500ms)/ 10(1000ms)	03		

Code	Name	Data range	Initial value	Note	Page
UE-01	EzSQ execution cycle	00(1ms)/ 01(2ms:SJ700/L700 compatible)	00		16-6
UE-02	EzSQ enable setting	00(Disable)/ 01([PRG] terminal)/ 02(Always enabled)	00		
UE-10	EzSQ User parameter U(00)	0 to 65535	0		
UE-11	EzSQ User parameter U(01)	0 to 65535	0		
UE-12	EzSQ User parameter U(02)	0 to 65535	0		
UE-13	EzSQ User parameter U(03)	0 to 65535	0		
UE-14	EzSQ User parameter U(04)	0 to 65535	0		
UE-15	EzSQ User parameter U(05)	0 to 65535	0		
UE-16	EzSQ User parameter U(06)	0 to 65535	0		
UE-17	EzSQ User parameter U(07)	0 to 65535	0		
UE-18	EzSQ User parameter U(08)	0 to 65535	0		
UE-19	EzSQ User parameter U(09)	0 to 65535	0		
UE-20	EzSQ User parameter U(10)	0 to 65535	0		
UE-21	EzSQ User parameter U(11)	0 to 65535	0		
UE-22	EzSQ User parameter U(12)	0 to 65535	0		
UE-23	EzSQ User parameter U(13)	0 to 65535	0		
UE-24	EzSQ User parameter U(14)	0 to 65535	0		
UE-25	EzSQ User parameter U(15)	0 to 65535	0		
UE-26	EzSQ User parameter U(16)	0 to 65535	0		
UE-27	EzSQ User parameter U(17)	0 to 65535	0		
UE-28	EzSQ User parameter U(18)	0 to 65535	0		
UE-29	EzSQ User parameter U(19)	0 to 65535	0		
UE-30	EzSQ User parameter U(20)	0 to 65535	0		
UE-31	EzSQ User parameter U(21)	0 to 65535	0		
UE-32	EzSQ User parameter U(22)	0 to 65535	0		
UE-33	EzSQ User parameter U(23)	0 to 65535	0		
UE-34	EzSQ User parameter U(24)	0 to 65535	0		
UE-35	EzSQ User parameter U(25)	0 to 65535	0		
UE-36	EzSQ User parameter U(26)	0 to 65535	0		
UE-37	EzSQ User parameter U(27)	0 to 65535	0		
UE-38	EzSQ User parameter U(28)	0 to 65535	0		
UE-39	EzSQ User parameter U(29)	0 to 65535	0		
UE-40	EzSQ User parameter U(30)	0 to 65535	0		

Code	Name	Data range	Initial value	Note	Page
UE-41	EzSQ User parameter U(31)	0 to 65535	0		16-6
UE-42	EzSQ User parameter U(32)	0 to 65535	0		
UE-43	EzSQ User parameter U(33)	0 to 65535	0		
UE-44	EzSQ User parameter U(34)	0 to 65535	0		
UE-45	EzSQ User parameter U(35)	0 to 65535	0		
UE-46	EzSQ User parameter U(36)	0 to 65535	0		
UE-47	EzSQ User parameter U(37)	0 to 65535	0		
UE-48	EzSQ User parameter U(38)	0 to 65535	0		
UE-49	EzSQ User parameter U(39)	0 to 65535	0		
UE-50	EzSQ User parameter U(40)	0 to 65535	0		
UE-51	EzSQ User parameter U(41)	0 to 65535	0		
UE-52	EzSQ User parameter U(42)	0 to 65535	0		
UE-53	EzSQ User parameter U(43)	0 to 65535	0		
UE-54	EzSQ User parameter U(44)	0 to 65535	0		
UE-55	EzSQ User parameter U(45)	0 to 65535	0		
UE-56	EzSQ User parameter U(46)	0 to 65535	0		
UE-57	EzSQ User parameter U(47)	0 to 65535	0		
UE-58	EzSQ User parameter U(48)	0 to 65535	0		
UE-59	EzSQ User parameter U(49)	0 to 65535	0		
UE-60	EzSQ User parameter U(50)	0 to 65535	0		
UE-61	EzSQ User parameter U(51)	0 to 65535	0		
UE-62	EzSQ User parameter U(52)	0 to 65535	0		
UE-63	EzSQ User parameter U(53)	0 to 65535	0		
UE-64	EzSQ User parameter U(54)	0 to 65535	0		
UE-65	EzSQ User parameter U(55)	0 to 65535	0		
UE-66	EzSQ User parameter U(56)	0 to 65535	0		
UE-67	EzSQ User parameter U(57)	0 to 65535	0		
UE-68	EzSQ User parameter U(58)	0 to 65535	0		
UE-69	EzSQ User parameter U(59)	0 to 65535	0		
UE-70	EzSQ User parameter U(60)	0 to 65535	0		
UE-71	EzSQ User parameter U(61)	0 to 65535	0		
UE-72	EzSQ User parameter U(62)	0 to 65535	0		
UE-73	EzSQ User parameter U(63)	0 to 65535	0		

Code	Name	Data range	Initial value	Note	Page
UF-02	EzSQ User parameter UL(00)	-2147483647 to 2147483647	0		16-6
UF-04	EzSQ User parameter UL(01)	-2147483647 to 2147483647	0		
UF-06	EzSQ User parameter UL(02)	-2147483647 to 2147483647	0		
UF-08	EzSQ User parameter UL(03)	-2147483647 to 2147483647	0		
UF-10	EzSQ User parameter UL(04)	-2147483647 to 2147483647	0		
UF-12	EzSQ User parameter UL(05)	-2147483647 to 2147483647	0		
UF-14	EzSQ User parameter UL(06)	-2147483647 to 2147483647	0		
UF-16	EzSQ User parameter UL(07)	-2147483647 to 2147483647	0		
UF-18	EzSQ User parameter UL(08)	-2147483647 to 2147483647	0		
UF-20	EzSQ User parameter UL(09)	-2147483647 to 2147483647	0		
UF-22	EzSQ User parameter UL(10)	-2147483647 to 2147483647	0		
UF-24	EzSQ User parameter UL(11)	-2147483647 to 2147483647	0		
UF-26	EzSQ User parameter UL(12)	-2147483647 to 2147483647	0		
UF-28	EzSQ User parameter UL(13)	-2147483647 to 2147483647	0		
UF-30	EzSQ User parameter UL(14)	-2147483647 to 2147483647	0		
UF-32	EzSQ User parameter UL(15)	-2147483647 to 2147483647	0		

<Unit options>

No.	Unit
00	non
01	%
02	A
03	Hz
04	V
05	kW
06	W
07	hr
08	s
09	kHz
10	ohm
11	mA
12	ms
13	P
14	kgm ²
15	pls
16	mH
17	Vdc
18	°C
19	kWh
20	mF
21	mVs/rad
22	Nm
23	min ⁻¹
24	m/s
25	m/min
26	m/h
27	ft/s
28	ft/min
29	ft/h
30	m

No.	Unit
31	cm
32	°F
33	l/s
34	l/min
35	l/h
36	m ³ /s
37	m ³ /min
38	m ³ /h
39	kg/s
40	kg/min
41	kg/h
42	t/min
43	t/h
44	gal/s
45	gal/min
46	gal/h
47	ft ³ /s
48	ft ³ /min
49	ft ³ /h
50	lb/s
51	lb/min
52	lb/h
53	mbar
54	bar
55	Pa
56	kPa
57	PSI
58	mm

(Memo)

**Appendix
2**

Appendix 2 Index

Contents

A2.1 What This Chapter Explains..... Appendix 2-1
A2.2 Index..... Appendix 2-2
A2.3 Revision History Appendix 2-6

A2.1 What This Chapter Explains

An index is provided in this chapter.
To search a document, use single-byte alphanumeric characters.

A2.2 Index

Numerics

1.7th power	12-9-4
2CH	12-8-3
2-step acceleration/deceleration	12-8-3
2nd-motor control	12-17-1
3-Wire	12-5-4

A

a/b (input terminal)	12-24-4
a/b (output terminal)	12-25-4
Absolute position control	12-17-25
AC0,AC1,AC2,AC3	12-19-4
Acceleration curve constant	12-8-10
Acceleration or deceleration pattern	12-8-7
Acceleration stop	12-8-8
Acceleration time	12-8-1
Acceleration time for Multi-speed	12-8-5
Accumulated input power	13-14
Accumulated output power	13-15
Accumulated pwer-on time	13-11
Accumulated RUN time	13-11
Active frequency matching	12-14-6
ADD	12-4-15
Add frequency	12-4-15
AHD	12-4-17
Ai1,Ai2,Ai3	7-33,12-24-9
Ai1Dc to Ai6DC	12-22-1,12-22-4
AL	12-19-1
Alarm code	12-19-4
Alarm relay output terminal	7-31
Analog command holding	12-4-17
Analog disconnection detection	12-22-1
Analog input	7-26,7-33,12-24-9
Analog input filter	12-24-12
Analog input/output status monitor	13-21
Analog output	7-33,12-25-13
Ao1,Ao2	7-33,12-25-13
APR (Automatic Position Regulator)	12-17-24
Arrival frequency	12-21-2
Arrival frequency	12-21-2
ASR (Automatic Speed Regulator)	12-11-2
Assist bar information	9-22
ATR	12-11-13
Auto tuning	12-3-6
Automatic carrier frequency reduction	12-12-2
Automatic torque boost	12-9-7
AVR (Automatic voltage regulation)	12-3-3

B

Base frequency	12-3-1
Battery	9-21,9-41
BER	12-17-5
BOK	12-17-5
Brake control	12-17-5
Braking resistor overload	12-13-8
BRD	7-22,12-13-8
BRD load rate monitor	13-19
BRK	12-17-5

C

Capacitor life curve	19-6
Carrier frequency	12-12-1
CAS	12-11-2,12-11-5
CF1,CF2,CF3,CF4	12-4-13
CM1	7-35
CM2	7-31
COK	12-17-10
Commercial switching	12-17-2
Communication disconnection	14-5
Communication error selection	14-6
Communication function	14-1
Compare mode	9-36
CON	12-17-10
Constant frequency reached	12-21-1
Constant torque characteristics	12-9-3
Constant torque electronic thermal	12-7-3
Contact control	12-17-10
Control circuit terminal	7-26
Control gain switch	12-11-2
Control mode	12-9-1
Cooling fan	12-18-1,12-19-14
Cooling fan rotation speed reduction	12-19-3
Cooling fin	12-12-3,12-19-12
Cooling fin temperature monitor	13-13
Copy Data	9-18
CP1,CP2,CP3,CP4	12-17-27
CPU error	12-19-3
CS	12-17-2
Current Derating	20-19

D

Data comparison display	9-32
DB	12-15-5
DC braking	12-14-2,12-15-2
DC bus voltage monitor	13-10
Deceleration curve constant	12-8-10
Deceleration time	12-8-1
Deceleration time for Multi-speed	12-8-5
Delaying and holding output signals	12-25-6
Direction reversal protection	12-6-3
DISP	9-39,12-5-6
Display restriction selection	9-25
DSE	12-16-11
DTR	16-8

E		H	
ECOM	14-22	H.....	7-33
Electrolytic Capacitors Life-Span	12-19-13	Heat sink	4-2, 6-5, 12-19-12
Electronic gear	12-17-20	High torque multi-operation	12-11-10
Electronic thermal	12-7-1	HLD.....	12-8-8
Electronic thermal warning level (Inverter) ..	12-19-11	Home search function.....	12-17-22
Electronic thermal warning level (Motor).....	12-19-10	Homing.....	12-17-29
EMBP.....	12-17-15		
EMC.....	1-8	I	
EMC Filter	7-23	Initialization	12-2-3
Emergency-force drive	12-17-13	Input phase loss	12-16-1
EMF	12-17-13	Input power monitor	13-14
EMFC	12-17-13	Input terminal response time	12-24-5
Encoder feedback	12-9-24, 12-9-35	Inspection	19-1
End rate	12-24-5	Instantaneous power failure	12-13-11
End value	12-24-5	Instantaneous power failure allowed time.....	12-14-4
Energy saving	12-9-9	Instantaneous power failure non-stop.....	12-13-17
European Directive (CE)	1-8	Intelligent input terminal	7-30, 12-24-1
EXT.....	12-16-3	Intelligent output terminal.....	7-31, 12-25-1
External Dimensions	20-7	IP.....	12-19-8
External thermistor	7-34	IPS	12-13-17
External trip	12-16-3	IRDY.....	12-20-4
EzCOM.....	14-22	IVMS start mode.....	12-9-30
EzSQ.....	16-3		
		J	
F		J51 connector	7-19
F/R.....	12-5-4	JG.....	12-17-4
FA1 to FA5.....	12-21-1, 12-21-2, 12-21-3	Jogging	12-17-4
Factory setting.....	12-2-3	Jump frequency.....	12-16-10
FBV,FBV2,FBV3,FBV4	12-10-29		
FM.....	7-35	K	
FOC.....	12-14-13	Keypad disconnection.....	9-40
F-OP	12-4-18, 12-5-7	KHC	13-14
Forcing	12-14-13		
Forward rotation.....	12-4-2, 12-5-3	L	
FOT	12-17-30	L	7-33
FR	12-20-3	LAC.....	12-8-11
Free electronic thermal.....	12-7-3	LAD.....	2-3
Free run stop.....	12-14-11, 12-15-1	LBK	9-41
Free V/f control.....	12-9-5	LD (Low Duty).....	12-2-1
FREF.....	12-4-2	Life alarming output.....	19-6
Frequency conversion	13-4	Life assessment monitor	13-16
Frequency limit	12-6-1	Load type selection	12-2-1
Frequency matching	12-14-3	LOC,LOC2	12-19-7
Frequency reference.....	12-4-1	LOG1 to LOG7.....	12-23-1
Frequency reference monitor	13-3	Logical operation	12-23-1
FRS	12-14-11, 12-15-1	Low current indication.....	12-19-7
Functional safety.....	1-9, 21-37	Lower frequency limit.....	12-6-1
FUP / FDN.....	12-4-16		
FW.....	12-5-3		
FWR.....	12-20-2		
G			
Gain mapping.....	12-11-2		
Gain switch (CAS).....	12-11-2		
Gain switch (PID).....	12-10-14		
Ground fault.....	18-16		

M

Main circuit terminal	7-6,7-13
Maintenance and inspection	19-1
Major failure	12-19-3
Manual torque boost	12-9-10
Maximum frequency	12-3-1
Megger test	19-4
Memory error	12-19-3
MI1 to MI11	16-6
Minimum frequency	12-6-1,12-14-1
MJA	12-19-3
MO1 to MO7	16-6
ModBus-RTU mode	14-1
Monitor functions	13-1
Motor constant	12-3-4
Motor gear ratio	12-9-35
Motor rated voltage	12-3-1
Multistage input determination time	12-4-12
Multistage position	12-17-27
Multi-stage speed	12-4-12

N

ND (Normal Duty)	12-2-1
NDc	14-5
NO/NC	12-25-4

O

OD	12-10-28
OHF	12-19-12
OKHC	13-15
OL,OL2	12-19-6
OLR	12-13-2
ONT	12-19-16
Operator keypad	7-25,9-2
ORG	12-17-29
ORL	12-17-29
ORT	12-17-22
OTQ	12-11-9
Output current monitor	13-9
Output frequency monitor	13-2
Output phase loss	12-16-2
Output power monitor	13-15
Output terminal off-delay time	12-25-6
Output terminal on-delay time	12-25-6
Output torque monitor	12-11-15
Output voltage gain	12-9-11
Output voltage monitor	13-10
Over current suppression	12-13-3
Over speed detection	12-16-12
Over torque	12-11-9
Overload restriction	12-13-1
Overload warning notice	12-19-6
Overvoltage suppression	12-13-4
OVS	12-19-17

P

P/PI control mode selection	12-11-2,12-11-5
P+/P-	7-35
P24	7-35
Password	9-34
PCC	12-24-16
PCLR	12-17-21,12-17-25
PCMP	12-24-16
PDD	12-17-21
Phase loss protection	12-16-1,12-16-2
PID	12-10-13
PID sleep	12-10-17
PID soft start	12-10-15
PID2,PID3,PID4	12-10-27
PIDC	12-10-13
PIDC2,PIDC3,PIDC4	12-10-27
PIO1,PIO2	12-10-22
PLA,PLB	12-9-35,12-24-16
PLZ	12-17-22
POK	12-17-22,12-17-25
Position deviation	12-17-21
Power supply overvoltage	12-19-17
PPI	12-11-2,12-11-5
Pre-set position	12-17-31
PRG	16-6
PRO	12-10-14
Program counter	16-5
Program NO. monitor	16-5
Programmable logic controller	17-2
PSET	12-17-30
Pulse count monitor	12-24-16
Pulse train frequency	12-4-5
Pulse train position control	12-17-17
PUP / PDN	12-17-21

Q

Query	14-6
-------	------

R

R0 / T0	7-19
Rated current	12-3-1,13-22
Read/Write	9-18,9-19
Reduced torque electronic thermal	12-7-2
Reduced voltage start	12-14-1
Reducing torque characteristics	12-9-4
REF	12-5-2
Relay output terminal	7-31,12-25-5
Remote operation	12-4-16
REN	12-6-4
Reset	12-24-10,12-24-6
Restart mode selection	12-13-9 to 12-13-16
Retry monitor	18-5
Reverse rotation	12-4-2,12-5-3
RNT	12-19-15
ROT	12-17-30
Rotation direction monitor	13-7
RS	12-24-6
RS485	7-35,12-24-6,14-1
RTC(Real-time clock)	18-24
RUN	12-20-1

RUN command input source selection 12-5-2
 RUN direction restriction 12-6-2
 RUN-key command rotation direction 12-5-2
 RV 12-5-3
 RVR 12-20-2

S

SCHG 12-4-10
 Scroll mode 9-7
 Secondary resistance (R2) correction 12-9-12
 Sensorless vector control (SLV) 12-9-12
 Servo lock 12-15-6, 12-17-33
 SET 12-17-1
 SETM 12-17-1
 SF1 to SF7 12-4-13
 SFT 9-24
 Simulation mode 10-8, 12-24-15
 Sink logic 7-26, 17-2
 Slide switches (SW) 7-26
 Soft-lock 9-24
 SON 12-17-33
 Source logic 7-26, 17-2
 SPD 12-17-27
 Specifications 20-1
 Speed deviation 12-16-11
 Speed limit at torque control 12-11-14
 Speed limit in APR control 12-17-24
 Speed response 12-9-12, 12-9-14, 12-9-24
 Sprinkle carrier pattern 12-12-4
 SSE 12-10-16
 STA / STP 12-5-4
 Stabilization constant 12-9-11
 Start rate 12-24-9
 Start value 12-24-9
 STAT 12-17-17
 STO terminal 7-36, 21-37
 Stop mode selection 12-15-1
 STOP-key enable 12-5-6
 SVC1, SVC2, SVC3, SVC4 12-10-9
 Synchronous start mode 12-9-28
 System settings 9-20

T

TBS 12-11-11
 TCH 12-17-28
 Test run 10-2
 TH+/TH- 7-34
 THC 12-19-11
 Thermistor 12-7-6
 THM 12-19-10
 TL 12-11-7
 Torque bias 12-11-11
 Torque boost 12-9-7, 12-9-10
 Torque control 12-11-1
 Torque limit 12-11-7
 Torque limit LADSTOP 12-11-8
 Torque reference 12-11-14
 Torque reference monitor 12-11-15
 TRA 16-7
 Trace function 16-7

Trip count monitor 18-3
 Trip monitor 18-3
 Troubleshooting 18-1
 TRQ 12-11-7
 TRQ1, TRQ2 12-11-7

U

UDC 12-4-16
 UL standards 1-7
 Unattended start protection 12-16-4
 Under voltage 12-13-9
 UP/DOWN function 12-4-16
 Upper frequency limit 12-6-1
 USP 12-16-4
 UV 12-19-9

V

V/f Control 12-9-3
 Vector control with encoder (CLV) 12-9-24
 Version 4-4, 21-28
 VLD (Very Low Duty) 12-2-1

W

WAC 12-19-13
 WAF 12-19-14
 WAKE 12-10-17
 Warning Display 18-33
 Warning monitor 18-38
 WCAi1 to WCAi6 12-22-1, 12-22-4
 Window comparator 12-22-1, 12-22-4

Z

Zero speed 12-21-4
 Zero-Hz range sensorless
 vector control (IM-0Hz-SLV) 12-9-14
 ZS 12-21-4

A2.3 Revision History

Revision History

No.	Revision details	Date
NT251	Initial edition	2016/7
NT251AX	Addition of specifications due to expansion of product capacity, correction of errors	2016/11
NT251BX	Addition and correction of functions for Ver2.00. -> See changes in 21.3 P1 Ver.2.00	2016/12
NT251BX-1	Correction of errors (incorrect parameter number, etc.)	2017/3
NT251BX-2	Correction of errors (correction of errors in instructions of operator pad, correction of analog hold explanatory drawing), addition of specifications due to expansion of product capacity	2017/5
NT251CX	unassigned number	-
NT251DX	unassigned number	-
NT251EX	unassigned number	-
NT251EX	<ul style="list-style-type: none"> - Added section "1.6.2 Precautions for Machinery Directives (Functional Safety)", because of the inverter has been complied the functional safety standards. - Added descriptions of models of 400V class 160kW to 315kW, mainly in chapters 1 to 7, 20, and 21. - Added replaced models from L700 series to P1 on "Chapter 21 Technical Notes". - Added the supplementary explanation of the firmware changes of Ver2.01, Ver2.02, Ver2.03 on section "21.3 Summary of Changes in Each Version". - Added change points on section 9.10.3, And added descriptions of section 9.10.5 to 9.10.7. - Other corrections such as typographical errors. 	2020/10

* Typographical errors may be corrected without prior notice.

