



Read this “Basic Guide”, and keep it handy for future reference.

## Basic Guide

HITACHI SJ Series Inverter

# P1



Introduction

Contents

Chapter 1: Safety Instructions

Chapter 2: Installation and Wiring

Chapter 3: Operation Setting and Examples of I/O Adjustment

Chapter 4: Settings

Chapter 5: FAQ / Troubleshooting

Chapter 6: Inspection and Maintenance

Chapter 7: Specifications

Appendix

Index

If you have any inquiry or problem,  
Refer to Chapter 5 FAQ/Troubleshooting  
or  
Contact to the Technical Inquiry Service  
for Inverter.

When making a contact, inform  
the reference number on below.

**NT2511EX**



## S.1 Introduction

Thank you for purchasing Hitachi SJ Series P1 Inverter. This is a guide that describes the basic handling and maintenance of the SJ Series P1 inverter. (Afterward "Hitachi SJ Series P1 Inverter" referred as SJ-P1.)

For the purpose of reduction paper consumption and provision of the latest information, we enclose the Basic Guide only, while providing the User's Guide for more detailed description through electronic means instead of CD or a printed document.

### ■ About the Basic Guide (this document)

The Basic Guide provides the minimum information necessary for handling the product. Make sure to read this document as well as the User's Guide for more detailed information.

### ■ About the User's Guide

The User's Guide provides detailed information necessary for handling the product. Make sure to read the User's Guide for proper use.

If future updated descriptions differ from the Basic Guide, the description in the User's Guide will have higher priority. Always use the SJ-P1 strictly within the range described in the User's Guide and perform proper inspection and maintenance to prevent failures or accidents.

Please note that the P1 User's Guide basically provided as electronic data (such as PDF).

The latest version of the User's Guide, please contact the supplier where this device was purchased.

### ■ Handling an optional products

When using optional products, refer to the instruction manual, Basic Guide, User's Guide, and other related technical documents attached to the product.

Please note that, like the SJ-P1 User's Guide, some optional products may also provide the User Guide and other documents as electronic data (such as PDF).

For more details, please contact the supplier where this device was purchased.

## S.2 Cautions

### ■ For a proper use

Before using the inverter, carefully read the Basic Guide, User's Guide of inverter and the instruction manuals for optional products.

In addition, any personnel handling or performing maintenance of the product must read carefully the inverter's Basic Guide, User's Guide and each optional products instruction manuals.

Before any attempt to install, operate, maintain or inspect this equipment, a complete understanding of the equipment specifications, safety instructions, precautions, handling and operation instructions is required. Follow all the specifications and instructions for a proper use. Additionally, review the inverter's Basic Guide, User's Guide and each optional product instruction manuals periodically.

### ■ Precautions

It is prohibited to reproduce or reform this document partially or totally in any form without the publisher's permission.

The contents of the document are subject to change without prior notice.

Any handling, maintenance or operation method NOT described on the inverter's Basic Guide, User's Guide and each optional product instruction manuals is not covered by the product warranty. DO NOT perform any procedure NOT described on the SJ-P1 and optional product guides since it can be the cause of unexpected failures or accidents.

We are not responsible for any impact from operations regardless of unexpected failure or accident due to operation or handling of the product in a manner not specified on the inverter's Basic Guide, User's Guide and each optional product instruction manuals. We appreciate your understanding.

If you find any unclear or incorrect description, missing description, or misplaced or missing pages, please inform the Hitachi inverter technical service office or the supplier where this device was purchased.

Note that, in case the inverter's Basic Guide, User's Guide and each optional product instruction manuals are enclosed, they should be delivered to the end user of the inverter. For details information, please contact the supplier where this device was purchased.

## S.3 Product Warranty and Inquiry

### ■ About Product Inquiry

- For an inquiry about product damage or faults or a question about the product, notify your supplier or Hitachi inverter technical service office.
- When contacting the technical service, please provide the following information.

- Model: P1 followed by model code on the specification label.
- Manufacturer Number (MFG No.): It shows on the specification label.
- Date of purchase: Purchase date by customer.
- Inquiry contents:
  - Inform us the defective point and its condition.
  - Inform us the suspicious content and its detail.

### ■ Product Warranty

- The product SJ-P1 will be warranted by Hitachi Industrial Equipment Systems Co., Ltd. (afterwards referred as "Hitachi") during the warranty period from your date of purchase only under proper usage of product.
- However, the warranty expressed here is covered only for products delivered from Hitachi, and will not be responsible for others damage or loss of products like a motor or any equipment or systems damage caused by improper usage of the product. We recommend applying safety design which is able to provide a hazard notice to the user in case of malfunction or damage of the delivered product to minimize the consequences on other equipment or system. We advise that the selection of the delivered product is done with sufficient margin for performance, as well as using redundant design for other equipment or systems. Also, the compatibility of the product with the customer's intended use is not warranted, hence the customer has the responsibility to perform validation tests before any operation.
- In case a defective product is delivered, or quality failure during the manufacturing process are detected, Hitachi will repair or exchange the product free of charge, only during the product warranty period (afterward, we call "warranty service").
- The product will be warranted for one year from the date of purchase. However, depending on the case, actual expenses for sending technical assistance will be charged to the customer. Also, Hitachi will not be responsible of any readjustment or testing on site.
- Warranty period for repaired or replaced part based on a warranty service is 6 months after the repair is completed for the relevant part. Hitachi will be responsible for repairing or exchanging the previously exchanged or repaired part only during this warranty period.

- In order to receive warranty service, you should present the receipt issued by the product supplier or any other document that allow us to check the purchase date. However, any defects, damage, malfunction or any other failure caused by one of the following facts will not be covered by warranty service.
  - (1) Cannot confirm the purchase date.
  - (2) The damage or fault resulted from improper usage or inadequate handling of the product or usage that does not comply with the instructions described in the User's Guide or Basic Guide.
  - (3) Incorrect usage of the product and/or the inverter, inadequate setting of the product and/or the inverter, remodeling or inadequate repair or repair carried out by an unqualified repair center.
  - (4) Deterioration and wear as result of normal operation.
  - (5) Fault resulted from natural disaster, such as earthquake, fire disaster, lightning strike, pollution, salt pollution, or abnormal voltage or any others external factors.
  - (6) Shock, falling, or Vibration resulted during transportation or displacement after purchase.
  - (7) Damage or fault resulted from remodeling firmware by unqualified personal not belonging to Hitachi.
  - (8) Damage or fault resulted from using a function program (EzSQ).

- By warranty service, It is very likely that parameters and customer created EzSQ program data will be lost. Make sure to back up by own responsibility. However, in case of malfunction resulting from the circuit board of the storage devices, the backup will not be possible. It is recommended to keep a backup during the testing phase by using keypad VOP or PC software ProDriveNext.

### ■ Liability Limitation

- In this product warranty, all warranties offered to the customer are stipulated, and neither Hitachi, affiliated companies nor related dealers are liable to any express warranties or implied warranties including, but not limited to, product merchantability or specific application fitness.
- Also, Hitachi, affiliated companies or related dealers are not responsible of any incidental damage, special damage, direct loss, or indirect loss (even predictable or not) sustained by the customer as a result of a faulty product.

## ■ Using the Warranty Service

- The customer is able to receive a warranty service during the warranty period from the product supplier or local Hitachi inverter sales office, if the product does not meet the specifications described in User's Guide or this guide. However, the User's Guide will have priority in case of mismatching content between this and the User's Guide.
- A fare-paying service can also be obtained by contacting your supplier, local Hitachi distributor, or local Hitachi inverter sales office.

## ■ Precautions for Product Operation

- The product should be operated following the working conditions, handling methods and precautions described in Basic Guide, User's Guide or other technical Document.
- Make sure that the Hitachi inverter is correctly configured and installed for the intended purpose in the designed system.
- When using the Hitachi inverter implement the take following actions.
  - (1) Select an inverter with sufficient capacity for the rated current and performance of customer facilities.
  - (2) Implement safety design such as redundant system design.
  - (3) Implement safety design which minimizes risks in case of an inverter failure.
  - (4) Design the system in a way it can warn the operator about any danger.
  - (5) Carry out periodic maintenance to the customer's equipment as well as the inverter.
- Hitachi inverter is designed and manufactured intentionally to be applied for general industrial equipment application. It is not intended to be used for the applications listed below therefore. In case inverter is used for these applications, it is out of warranty unless there is a special written agreement.
  - (1) For special application such as aircraft, spacecraft, nuclear, electric power, passenger transportation, medical, submarine repeater, etc.
  - (2) For application such as elevator, amusement equipment, medical equipment which might have a big effect on human life and property.
- Even for above application, in case there is an agreement for the limitation of the purpose and quality, please contact to our sales office. Further study will be carried out to check whether inverter is applicable for that specific application or not.
- For applications that involve human life, or have risk of important loss, make sure to avoid a critical accident by installing a fail-safe device, protecting device, detecting device, alarm device, or spare device, etc.
- This inverter is only for three phase induction motor [IM] or three phase synchronous motor [SM(PMM)].
- For any other application make inquiries.

## ■ Change on Product Specifications

- Please be aware that the information described in Brochure, Basic Guide, User's Guide or Technical Document might be modified without notice.

## ■ Supplement

- Refer to "Chapter 7 Specification" for short lifespan component.
- This warranty term will not restrict a legal right of customer who has purchased the product.
- Please contact your sales agent for warranty of products.

## ■ Contact Information

### Hitachi America, Ltd. (Charlotte Office)

Industrial Components and Equipment Division  
6901 Northpark Blvd., Suite A, Charlotte, NC 28216,  
U.S.A

TEL : +1(704) 494-3008  
FAX : +1(704) 599-4108

### Hitachi Europe GmbH

Industrial Components & Equipment Group  
Niederlasser Lohweg191, 40547 Dusseldorf,  
Germany

TEL : +49-211-5283-0  
FAX : +49-211-204-9049

### Hitachi Asia Ltd.

Industrial Components & Equipment Division  
No.30 Pioneer Crescent, #10-15 West Park Bizcentral,  
Singapore 628560,  
Singapore

TEL : +65-6305-7400  
FAX : +65-6305-7401

### Hitachi Australia Pty Ltd.

Suite 801, Level 8, 123 Epping Road, North Ryde, NSW, 2113,  
Australia

TEL : +61-2-9888-4100  
FAX : +61-2-9888-4188

### Hitachi Industrial Equipment Systems Co., Ltd.

AKS Building, 3, Kanda  
Neribeicho, Chiyoda-ku,  
Tokyo, 101-0022  
Japan

TEL : +81-3-4345-6529  
FAX : +81-3-4345-6913

## S.4 Related Basic / User's Guide

Document name	Document Number	Product bundle
SJ series P1 User's Guide	NT251*X	(*1)
SJ series P1 Basic Guide (This document)	NT2511*X	✓
SJ series P1 Safety function Guide	NT2512*X	(*1)
SJ series P1 Easy-Sequence Function(EzSQ) Programming Guide	NT252*X	(*1)
P1-FB Encoder Feedback option User's Guide	NT253*X	✓
P1-EN Ethernet Communication Option User's Guide	NT254*X	(*1)
P1-ECT EtherCAT Communication Option User's Guide	NT255*X	(*1)
P1-PB PROFIBUS Communication Option User's Guide	NT256*X	(*1)
P1-PN PROFINET Communication Option User's Guide	NT257*X	(*1)
P1-TM2 Screw control terminal block board Option User's Guide	NT259*X	✓
P1-AG Analog Input/Output Option User's Guide	NT260*X	✓
P1-CCL CC-Link Communication Option User's Guide	NT261*X	(*1)
P1-DN DeviceNet Communication Option User's Guide	NT262*X	(*1)
P1-FS Functional Safety Option Safety Function Guide	NT2582*X	✓
ProDriveNext instruction manual( HITACHI Inverter setting software) (In preparing. For details, please contact local Hitachi inverter sales office)	NT8001*X	(*1)

( The document version ("\*" is alphabet A, B, .... ) is added to the end of document code.)

(\*1) These are usually not bundled with the product but a simple basic guide is included.

For each User's Guides, please contact the supplier where this device was purchased or local Hitachi inverter sales office.

## S.5 Trademark

- CRIMPFOX® is a registered trademark of Phoenix Contact GmbH & Co. KG.
- Modbus® is a registered trademark of Schneider Automation Inc.
- EtherCAT® is registered trademark and patented technology, licensed by Beckhoff Automation GmbH, Germany.
- PROFIBUS® and PROFINET® is registered trademark of PROFIBUS Nutzerorganisation e.V. (PNO).
- CC-Link® is trade names of Mitsubishi Electric Co.
- DeviceNet® is the trademark of Open DeviceNet Vendor Association, Inc.

**C.1 Contents**

S.1 Introduction .....	S-1	S.4 Related Basic / User's Guide .....	S-4
S.2 Cautions .....	S-1	S.5 Trademark.....	S-4
S.3 Product Warranty and Inquiry .....	S-2	C.1 Contents .....	C-1

**Chapter 1 Safety Instructions**

1.1 Types of Warnings .....	1-1	1.4 Compliance to European Directive (CE) .....	1-5
1.2 Description of Safety Symbols.....	1-1	1.5 Compliance to UL standards .....	1-7
1.3 Cautions .....	1-2	1.6 Precautions for installation .....	1-11

**Chapter 2 Installation and Wiring**

2.1 Check the Inverter.....	2-1	2.7 Applicable circuit breaker .....	2-12
2.2 Install the Inverter.....	2-2	2.8 Chopper Breaking Resistor .....	2-14
2.3 Dimensions.....	2-5	2.9 Wiring to the main circuit terminal block .....	2-15
2.4 Inverter Wiring .....	2-8	2.10 Wiring of the control circuit.....	2-20
2.5 Wiring of the main circuit .....	2-9	2.11 Control circuit wiring section .....	2-22
2.6 Recommended wire size, wiring accessories and crimp terminals.....	2-10	2.12 Residual risk .....	2-27

**Chapter 3 Operation Setting and Examples of I/O Adjustment**

3.1 Set the load rating .....	3-1	3.8 Operate using 3WIRE terminal.....	3-4
3.2 Set the motor data .....	3-1	3.9 Adjust the analog input (Ai1/Ai2).....	3-5
3.3 Frequency setting on the keypad .....	3-2	3.10 Adjust the analog output (Ao1/Ao2/FM) .....	3-5
3.4 Run key using the on the keypad .....	3-2	3.11 Adjust the analog input (Ai3) .....	3-6
3.5 Multispeed terminals command .....	3-3	3.12 Input terminal chatter prevention .....	3-6
3.6 Operate using FW/RV terminal .....	3-3	3.13 Output terminals stabilization .....	3-6
3.7 Potentiometer frequency reference .....	3-4		

**Chapter 4 Settings**

4.1 Keypad overview .....	4-1	4.4 Parameters naming (Nomenclature).....	4-13
4.2 Monitor naming (Nomenclature).....	4-10	4.5 Parameter arrangement.....	4-13
4.3 Description of monitor functions .....	4-10	4.6 Parameter explanation.....	4-13

**Chapter 5 FAQ/Troubleshooting**

5.1 Error events.....	5-1	5.3 Possible errors and solutions .....	5-5
5.2 Confirming the status.....	5-3		

**Chapter 6 Inspection and Maintenance**

6.1 Inspection and maintenance notes.....	6-1	6.5 Checking method for inverter/converter.....	6-4
6.2 Daily and periodic inspections .....	6-2	6.6 Smoothing capacitor life span curve.....	6-5
6.3 Insulation resistance test .....	6-3	6.7 Lifespan alarm output .....	6-5
6.4 Dielectric withstand test .....	6-3	6.8 Input/output voltage, current and power measurement methods .....	6-6

**Chapter 7 Specifications**

7.1 200V class specifications .....	7-1	7.3 Common specifications .....	7-4
7.2 400V class specifications .....	7-2	7.4 Current derating .....	7-5

**Appendix & Index**

• SJ-P1 Ver.2.01 Supplement .....	A-1	• SJ-P1 Ver.2.03 Supplement .....	A-6
• SJ-P1 Ver.2.02 Supplement .....	A-2	• Quick start .....	A-8
		• Revision History .....	A-9
		• Index.....	Index-1

---

(Memo)





# Chapter 1 Safety Instructions

## 1.1 Types of Warnings

In the Basic Guide, the severity levels of safety precautions and residual risks are classified as: "DANGER", "WARNING" and "CAUTION".

Display meanings







 <b>DANGER</b>
<p>Indicates that incorrect handling may cause hazardous situations, which would most likely result in serious personal injury or death, and may result in major physical loss or damage.</p>
 <b>WARNING</b>
<p>Indicates that incorrect handling may cause hazardous situations, which may result in serious personal injury or death, and may result in major physical loss or damage.</p>
 <b>CAUTION</b>
<p>Indicates that incorrect handling may cause hazardous situations, which may result in moderate or slight personal injury or damage, and may result in only physical loss or damage.</p>

Furthermore, "**CAUTION**" level description may lead to a serious risk depend on the circumstances. Be sure to follow the instruction because whichever contains important safety description.

## 1.2 Description of Safety Symbols

This document contains annotations with graphic symbols. Be sure to pay close attention to the contents and be sure to follow them.

Symbols meaning

	<p>Indicates a danger, warning or caution notice for fire, electric shock and high temperature while handling the product. Details are indicated in or near  by pictures or words.</p>
	<p>The drawing on the left indicates "a non-specific and general danger or caution".</p>
	<p>The drawing on the left indicates "a possible damage due to electric shock".</p>
	<p>Indicates "what you must not do" to prohibit the described acts in the operation of the product.</p>
	<p>Indicates "what you must do" according to the instructions in the operation of the product.</p>

1.3 Cautions

Read carefully following safety instruction for handling.

1.3.1 Please be Careful!

 **DANGER**

 **Caution**

- If handled incorrectly or improperly, it might cause death, serious physical injuries, or damage to the inverter, motor or even the entire system.

 **Do**

- Before installation, wiring, operation, inspection, or usage, read and fully understand this guide.

 **Caution**

- In order to explain this device details the illustrations in this guide might show this device without covers.
- Before operating this device please return all the covers to the original position, and follow all the necessary regulations and instructions written in this guide.

 **Do**

1.3.2 Precautions during the installation!

 **WARNING**

 **Fire Hazard**

- **Risk of Fire!**
- DO NOT place inflammable objects nearby.
- DO NOT let scraps of wire, welding sputtering, irons scraps or other objects get inside the device.

 **Prohibited**

- Avoid installing this device in places with high temperature, high humidity, Condensation-prone conditions, dusty conditions, corrosive gas, grinding fluid mist, hydrogen sulfide or salt damage prone conditions. Additionally, it is recommended to install this device in ventilated room not exposed to direct sunlight.

 **Do**

 **Fall Injury**

- **Risk of injury due to the inverter falling!**
- DO NOT hold its cover parts when carrying the inverter.

 **Prohibited**

- Install the inverter on a structure able to bear the weight specified in this Basic Guide.
- Install the inverter on a vertical wall that is free of vibrations.

 **Do**

 **Injury**

- **Risk of Injury!**
- DO NOT install or operate products with damage or missing parts.

 **Prohibited**

 **Failure**

- **Risk of failure of the inverter!**
- The device is a precision equipment, do not drop it, or give it a strong shock.
- DO NOT get on (step on) or place heavy objects on this device.

 **Prohibited**

1.3.3 Precautions for Wiring

 **DANGER**

 **Electric shock Fire**

- **Risk of an electric shock and/or fire!**
- Be sure to ground the inverter.
- Entrust the wiring work only to a qualified electrician.
- Before the wiring work make sure to turn off the power supply and wait for more than 10 or 15 minutes depending on the inverter model\*1. (Confirm that the charge lamp is OFF and the DC bus voltage between terminals P and N is 45V or less.)

 **Do**

 **Electric shock**

- **Risk of an electric shock and/or injury!**
- Perform the wiring only after installing the inverter.

 **Do**

 **Failure**

- **Risk of failure of the inverter!**
- Do not pull the wire after wiring.

 **Prohibited**

 **Short circuit Ground fault**

- **Risk of short circuit and ground fault!**
- Do not remove rubber bushings from the wiring section. Otherwise, the edges of the wiring cover may damage the wire.

 **Prohibited**

\*1) For P1-00044-L to P1-01240-L (P1-004L to P1-220L), P1-00041-H to P1-00620-H (P1-007H to P1-220H) models the wait time is 10 minutes.  
For P1-01530-L to P1-02950-L (P1-300L to P1-550L), P1-00770-H to P1-06600-H (P1-300H to P1-3150H) models the wait time is 15 minutes.

 **WARNING**
**Injury****Prohibited****Do**

- Risk of injury or fire!
- Do not connect AC power supply to any of the output terminals (U, V, and W).
- Make sure that the voltage of AC power supply matches the rated voltage of your inverter.

**Electric shock  
Injury****Do**

- Risk of electric shock and injury!
- Before operating slide-switch(SW) in the inverter, be sure to turn off the power supply.
- Since the inverter supports two modes of cooling-fan operation, the inverter power is not always off, even when the cooling fan is stopped. Therefore, be sure to confirm that the power supply is off before wiring.

**Fire****Prohibited****Do**

- Risk of fire!
- DO NOT use a single-phase input.
- DO NOT connect a resistor directly to any of the DC terminals (PD, P, and N).
- DO NOT use the magnetic contactor installed on the primary and secondary sides of the inverter to stop its operation.
- Tighten each screw to the specified torque.
- No screws must be left loose.
- Connect an earth-leakage breaker to the power input circuit.
- Use only the power cables, earth-leakage breaker, and magnetic contactors that have the specified capacity (ratings).

## 1.3.4 Precautions to Run and Test Running

 **DANGER**
**Electric shock  
Fire****Prohibited**

- Risk of electric shock or fire!
- While power is supplied to the inverter, do not touch any internal part or terminal of the inverter. Also do not check signals, or connect or disconnect any wire or connector.
- While power is supplied to the inverter, do not touch any internal part of the inverter. Also do not insert a material such as a rod and etc.

**Electric shock****Prohibited**

- Risk of electric shock!
- Be sure to close the terminal block cover before turning on the inverter power. Do not open the terminal block cover while power is being supplied to the inverter or voltage remains inside.
- Do not operate switches with wet hands.

**Injury  
Fire****Prohibited**

- Risk of injury or fire!
- While power is supplied to the inverter, do not touch the terminal of the inverter, even if it has stopped.

**Injury  
Damage****Prohibited**

- Risk of injury and damage to machine!
- Do not select the retry mode for controlling an elevating or traveling device because free-running status occurs in retry mode.

**Injury****Prohibited****Do**

- Risk of injury!
- If the retry mode has been selected, the inverter will restart suddenly after a break in the tripping status. Stay away from the machine controlled by the inverter when the inverter is under such circumstances. (Design the machine so that human safety can be ensured, even when the inverter restarts suddenly.)
- The [STOP] key on the operator keypad is effective only when its function is enabled by setting. Prepare an emergency stop switch separately.
- If an RUN command has been input to the inverter before a short-term power failure, the inverter may restart operation after the power recovery. If such a restart may put persons in danger, design a control circuit that disables the inverter from restarting after power recovery.
- If an RUN command has been input to the inverter before the inverter enters alarm status, the inverter will restart suddenly when the alarm status is reset. Before resetting the alarm status, make sure that no RUN command has been input.

**WARNING**

 **Injury Damage**

- **Risk of injury and damage to machine!**
- The inverter easily allows you to control the speed of operating motor. Confirm the capacity and ratings of the motor or machine before operating.
- When you run the motor at a high frequency, check and confirm to each manufactures of a permitting revolution of the respective motor and machine.
- Check the rotate motor direction, abnormal sound, and vibrations while operating.

 **Do**

 **Burn Injury**

- **Risk of burn injury.**
- Inverter heat sink will heat up during operation. Do not touch the heat sink.

 **Prohibited**

 **Injury**

- **Risk of injury!**
- Install an external brake system if needed.

 **Do**

1.3.5 Precautions for Maintenance/Inspection

**DANGER**

 **Electric shock**

- **Risk of electric shock!**
- Before inspecting the inverter, be sure to turn off the power supply and wait for more than 10 or 15 minutes depending on the inverter model\*1. (Before inspection, confirm that the Charge lamp on the inverter is off and the DC bus voltage between terminals P and N is 45 V or less.)

 **Do**

 **Prohibited**

- Commit only a designated person to maintenance, inspection, and the replacement of parts. (Be sure to remove wristwatches and metal accessories, e.g., bracelets, before maintenance and inspection work and to use insulated tools for the work.)

\*1) For P1-00044-L to P1-01240-L (P1-004L to P1-220L), P1-00041-H to P1-00620-H (P1-007H to P1-220H) models the wait time is 10 minutes.  
For P1-01530-L to P1-02950-L (P1-300L to P1-550L), P1-00770-H to P1-06600-H (P1-300H to P1-3150H) models the wait time is 15 minutes.

1.3.6 Precautions for disposal

**DANGER**

 **Injury Explosion**

- **Risk of injury and explosion!**
- For disposal of the inverter, outsource to a qualified industrial waste disposal contractor. Disposing of the inverter on your own may result in an explosion of the capacitor or produce poisonous gas.
- Contact us or your distributor for fixing the inverter.

 **Do**

- A qualified industrial waste disposal contractor includes industrial waste collector/ transporter and industrial waste disposal operator. Follow the laws and regulations of each country for disposing of the inverter.

1.3.7 Other Cautions

**DANGER**

 **Electric shock Fire**

- **Risk of electric shock, fire and injury!**
- Never modify the inverter.

 **Prohibited**

**CAUTION**

 **Life cycle**

- **Risk of significantly shortening the life cycle of a product!**
- Sterilizing and disinfecting a packaging wood materials use a means other than wood fumigation method. If the product is exposed to the fumigation treatment, electronic parts receive a critical damage from emitted gases or steams. Especially, halogen disinfectants (including fluorine, chlorine, bromine and iodine) can cause corrosion in the capacitor.

 **Do**

## 1.4 Compliance to European Directive (CE)

### 1.4.1 Caution for EMC (Electromagnetic Compatibility)

The SJ series P1 inverter conforms to requirements of Electromagnetic Compatibility (EMC) Directive (2014/30/EU). However, when using the inverter in Europe, you must comply with the following specifications and requirements to meet the EMC Directive and other standards in Europe:



**WARNING:** This equipment must be installed, adjusted, and maintained by qualified engineers who have expert knowledge of electric work, inverter operation, and the hazardous circumstances that can occur. Otherwise, personal injury may result.

1. Power supply requirements
  - a. Voltage fluctuation must be -15% to +10% or less.
  - b. Voltage imbalance must be  $\pm 3\%$  or less.
  - c. Frequency variation must be  $\pm 4\%$  or less.
  - d. Total harmonic distortion (THD) of voltage must be  $\pm 10\%$  or less.
2. Installation requirement
  - a. SJ series P1 includes a built-in EMC filter. The built-in EMC filter must be activated.
  - b. According to EN61800-3 it is mandatory to mention that any inverter with only C3 filter inside may NOT be connected to a low voltage public power supply in residential areas since for these installations C1 is required.
  - c. In case of external filter for C2, an additional note is required according to EN61800-3 that "this product may emit high frequency interference in residential areas which may require additional EMC measures".
  - d. According to the EN61000-3-12, an additional AC reactor or DC choke should be installed for reducing harmonics in power line.
3. Wiring requirements
  - a. A shielded wire (screened cable) must be used for motor wiring, and the length of the cable must be according to the following table (Table 1 on page 1-6).
  - b. The carrier frequency must be set according to the following table to meet an EMC requirement (Table 1 on page 1-6).
  - c. The main circuit wiring must be separated from the control circuit wiring.
4. Environmental requirements (to be met when a filter used)
  - a. SJ series P1 inverter that is activated built-in EMC filter must be according to SJ series P1 specifications.

Table 1

Model	Cat.	Cable Length (m)	Carrier Frequency (kHz)	Model	Cat.	Cable Length (m)	Carrier Frequency (kHz)
P1-00044-L(P1-004L)	C3	3	2	-	-	-	-
P1-00080-L(P1-007L)	C3	3	2	P1-00041-H(P1-007H)	C3	3	2
P1-00104-L(P1-015L)	C3	3	2	P1-00054-H(P1-015H)	C3	3	2
P1-00156-L(P1-022L)	C3	3	2	P1-00083-H(P1-022H)	C3	3	2
P1-00228-L(P1-037L)	C3	3	2	P1-00126-H(P1-037H)	C3	3	2
P1-00330-L(P1-055L)	C3	5	2	P1-00175-H(P1-055H)	C3	5	2
P1-00460-L(P1-075L)	C3	5	2	P1-00250-H(P1-075H)	C3	5	2
P1-00600-L(P1-110L)	C3	5	2	P1-00310-H(P1-110H)	C3	5	2
P1-00800-L(P1-150L)	C3	10	1	P1-00400-H(P1-150H)	C3	10	2
P1-00930-L(P1-185L)	C3	10	1	P1-00470-H(P1-185H)	C3	10	2
P1-01240-L(P1-220L)	C3	10	1	P1-00620-H(P1-220H)	C3	10	2
P1-01530-L(P1-300L)	C3	5	2	P1-00770-H(P1-300H)	C3	5	2
P1-01850-L(P1-370L)	C3	5	2	P1-00930-H(P1-370H)	C3	5	2
P1-02290-L(P1-450L)	C3	5	2	P1-01160-H(P1-450H)	C3	5	2
P1-02950-L(P1-550L)	C3	5	2	P1-01470-H(P1-550H)	C3	5	2
-	-	-	-	P1-01760-H(P1-750H)	C3	3	2
-	-	-	-	P1-02130-H(P1-900H)	C3	3	2
-	-	-	-	P1-02520-H(P1-1100H)	C3	3	2
-	-	-	-	P1-03160-H(P1-1320H)	C3	3	2
				P1-03720-H (P1-1600H)	C3	3	2
				P1-04320-H (P1-1850H)	C3	3	2
				P1-04860-H (P1-2000H)	C3	3	2
				P1-05200-H (P1-2200H)	C3	3	2
				P1-05500-H (P1-2500H)	C3	3	2
				P1-06600-H (P1-3150H)	C3	3	2

#### 1.4.2 Caution for Machinery Directive

(Functional Safety)



**When using STO (Safe Torque Off) function be sure to read the "Safety functional Guide" of separate!**

SJ Series P1 conforms to STO (Safe Torque Off) defined in Functional Safety IEC 61800-5-2. When using the STO function refer to "SJ-P1 Safety Function Guide Supplement"(NT22512\*X) on the separate sheet. And further download "Safety function Guide (NT2512\*X)" from our website below and carefully read it.

Applicable models are P1-00044-L(P1-004L) to P1-02950-H(P1-550L) and P1-00041-H(P1-007H) to P1-03160-H(P1-1320H).

For details, refer to "Appendix EC Declaration of Conformity (Copy)" on page A-1 of "Safety function Guide (NT2512\*X)".

<https://www.hitachi-ies.co.jp/english/products/inv/sjp1/>

## 1.5 Compliance to UL standards

### 1.5.1 UL CAUTION

#### GENERAL:

SJ series Type P1 inverter is open type AC Inverter with three phase input and three phase output. It is intended to be used in an enclosure. It is used to provide both an adjustable voltage and adjustable frequency to the AC motor. The inverter automatically maintains the required volts-Hz ratio allowing the capability through the motor speed range. It is multi-rated device and the ratings are selectable according to load types by operator with key pad operation.

#### Markings:

##### Maximum Surrounding Temperature:

- ND (Normal Duty): 50degC
- LD (Low Duty): 45degC
- VLD (Very Low Duty): 40degC

#### Storage Environment rating:

- 65degC (for transportation)

#### Instruction for installation:

- Pollution degree 2 environment and Overvoltage category III

#### Electrical Connections:

- See Chapter "2.5 Wiring of the main circuit" of this guide.

#### Interconnection and wiring diagrams:

- See Chapter "2.10 Wiring of the control circuit" of this guide.

#### Short circuit rating and overcurrent protection device rating:

##### P1-L series models

- Suitable for use on a circuit capable of delivering not more than 5,000 rms symmetrical amperes, 240 V maximum".

##### P1-H series models

- Suitable for use on a circuit capable of delivering not more than 5,000 rms symmetrical amperes, 500 V maximum".

#### Integral:

- Integral solid state short circuit protection does not provide branch circuit protection. Branch circuit protection must be provided in accordance with the National Electrical Code and any additional local codes.

Field wiring terminal conductor size and Torque Values making for field wiring terminal:

:

**\*200V Class**

Model	Load Type	Required Torque(N·m)	Conductor size (AWG)
P1-00044-L (P1-004L)	VLD	1.4	14
	LD		
	ND		
P1-00080-L (P1-007L)	VLD	1.4	14
	LD		
	ND		
P1-00104-L (P1-015L)	VLD	1.4	14
	LD		
	ND		
P1-00156-L (P1-022L)	VLD	1.4	10
	LD		14
	ND		
P1-00228-L (P1-037L)	VLD	1.4	10
	LD		
	ND		
P1-00330-L (P1-055L)	VLD	3	8
	LD		
	ND		
P1-00460-L (P1-075L)	VLD	3	6
	LD		8
	ND		
P1-00600-L (P1-110L)	VLD	4	4
	LD		6
	ND		
P1-00800-L (P1-150L)	VLD	2.5 to 3.0	3
	LD		4
	ND		
P1-00930-L (P1-185L)	VLD	2.5 to 3.0	1
	LD		2
	ND		3
P1-01240-L (P1-220L)	VLD	5.5 to 6.6	2/0
	LD		1/0
	ND		1
P1-01530-L (P1-300L)	VLD	6.0	Parallel of 1/0
	LD		Parallel of 1/0
	ND		2/0
P1-01850-L (P1-370L)	VLD	6.0 to 10.0	Parallel of 1/0
	LD	15.0	Parallel of 1/0
	ND		4/0
P1-02290-L (P1-450L)	VLD	6.0 to 10.0	Parallel of 2/0
	LD		Parallel of 1/0
	ND		Parallel of 1/0
P1-02950-L (P1-550L)	VLD	10.0 to 12.0	Parallel of 3/0
	LD		Parallel of 3/0
	ND		350kcmil

**\*400V Class**

Model	Load Type	Required Torque(N·m)	Conductor size (AWG)
P1-00041-H (P1-007H)	VLD/LD/ND	1.4	14
P1-00054-H (P1-015H)	VLD/LD/ND	1.4	14
P1-00083-H (P1-022H)	VLD/LD/ND	1.4	14
P1-00126-H (P1-037H)	VLD	1.4	12
	LD		14
	ND		
P1-00175-H (P1-055H)	VLD	3	10
	LD		12
	ND		
P1-00250-H (P1-075H)	VLD	3	8
	LD		10
	ND		
P1-00310-H (P1-110H)	VLD/LD/ND	4	8
P1-00400-H (P1-150H)	VLD/LD/ND	4	8
P1-00470-H (P1-185H)	VLD	4	6
	LD		8
	ND		
P1-00620-H (P1-220H)	VLD	4	4
	LD		6
	ND		
P1-00770-H (P1-300H)	VLD	2.5 to 3.0	1
	LD		2
	ND		3
P1-00930-H (P1-370H)	VLD/LD/ND	15.0	1
P1-01160-H (P1-450H)	VLD	15.0	1/0
	LD		1/0
	ND		1
P1-01470-H (P1-550H)	VLD	6.0 to 10.0	Parallel of 1/0
	LD	15.0	2/0
	ND		1/0
P1-01760-H (P1-750H)	VLD/LD/ND	10.0 to 12.0	Parallel of 1/0
P1-02130-H (P1-900H)	VLD	10.0 to 12.0	Parallel of 2/0
	LD		Parallel of 1/0
	ND		Parallel of 1/0
P1-02520-H (P1-1100H)	VLD	10.0 to 12.0	Parallel of 3/0
	LD		Parallel of 2/0
	ND		Parallel of 2/0
P1-03160-H (P1-1320H)	VLD	10.0 to 12.0	P. of 250kcmil
	LD		Parallel of 4/0
	ND		Parallel of 3/0
P1-03720-H (P1-1600H)	VLD	15.5 to 18.5	P. of 250kcmil
	LD		Parallel of 4/0
	ND		Parallel of 3/0
P1-04320-H (P1-1850H)	VLD	15.5 to 18.5	P. of 300kcmil
	LD		P. of 250kcmil
	ND		P. of 250kcmil
P1-04860-H (P1-2000H)	VLD	37.0	P. of 350kcmil
	LD		P. of 300kcmil
	ND		P. of 250kcmil
P1-05200-H (P1-2200H)	VLD	37.0	P. of 400kcmil
	LD		P. of 350kcmil
	ND		P. of 300kcmil
P1-05500-H (P1-2500H)	LD	37.0	P. of 500kcmil
	ND		P. of 400kcmil
P1-06600-H (P1-3150H)	LD/ND	37.0	P. of 600kcmil

– Use 75degC only for temperature rating of field wiring.

– Use Copper conductors only.



Required protection by Fuse and circuit-breakers:  
P1-L series models

Model	Type	Fuse		Circuit Breaker	
		Maximum Rating		Maximum Rating	
		Voltage (V)	Current (A)	Voltage (V)	Current (A)
P1-00044-L (P1-004L)	Class J or T	600	15	-	-
P1-00080-L (P1-007L)	Class J or T	600	30	-	-
P1-00104-L (P1-015L)	Class J or T	600	40	-	-
P1-00156-L (P1-022L)	Class J or T	600	40	-	-
P1-00228-L (P1-037L)	Class J or T	600	50	-	-
P1-00330-L (P1-055L)	Class J or T	600	100	-	-
P1-00460-L (P1-075L)	Class J or T	600	150	-	-
P1-00600-L (P1-110L)	Class J or T	600	150	-	-
P1-00800-L (P1-150L)	Class J or T	600	150	-	-
P1-00930-L (P1-185L)	Class J or T	600	200	-	-
P1-01240-L (P1-220L)	Class J or T	600	200	-	-
P1-01530-L (P1-300L)	Class J or T	600	300	-	-
P1-01850-L (P1-370L)	Class J or T	600	300	-	-
P1-02290-L (P1-450L)	Class J or T	600	400	-	-
P1-02950-L (P1-550L)	Class J or T	600	500	-	-

## P1-H series models

Model	Fuse			Circuit Breaker	
	Type	Maximum Rating		Maximum Rating	
		Voltage (V)	Current (A)	Voltage (V)	Current (A)
P1-00041-H (P1-007H)	Class J or T	600	15	-	-
P1-00054-H (P1-015H)	Class J or T	600	20	-	-
P1-00083-H (P1-022H)	Class J or T	600	30	-	-
P1-00126-H (P1-037H)	Class J or T	600	30	-	-
P1-00175-H (P1-055H)	Class J or T	600	75	-	-
P1-00250-H (P1-075H)	Class J or T	600	75	-	-
P1-00310-H (P1-110H)	Class J or T	600	75	-	-
P1-00400-H (P1-150H)	Class J or T	600	100	-	-
P1-00470-H (P1-185H)	Class J or T	600	100	-	-
P1-00620-H (P1-220H)	Class J or T	600	100	-	-
P1-00770-H (P1-300H)	Class J or T	600	200	-	-
P1-00930-H (P1-370H)	Class J or T	600	200	-	-
P1-01160-H (P1-450H)	Class J or T	600	200	-	-
P1-01470-H (P1-550H)	Class J or T	600	250	-	-
P1-01760-H (P1-750H)	Class J or T	600	300	-	-
P1-02130-H (P1-900H)	Class J or T	600	400	-	-
P1-02520-H (P1-1100H)	Class J or T	600	500	-	-
P1-03160-H (P1-1320H)	Class J or T	600	500	-	-
P1-03720-H (P1-1600H)	Class L	600	1000	-	-
P1-04320-H (P1-1850H)	Class L	600	1000	-	-
P1-04860-H (P1-2000H)	Class L	600	1000	-	-
P1-05200-H (P1-2200H)	Class L	600	1000	-	-
P1-05500-H (P1-2500H)	Class L	600	1000	-	-
P1-06600-H (P1-3150H)	Class L	600	1600	-	-

1.6 Precautions for installation

◆ Notes for P1-00600-L (P1-110L)



For the use of P1-00600-L (P1-110L) at low duty (LD)/very low duty (VLD), follow the installation procedures shown in the figure below.

Change [Ub-03] to 00 and [Ub-03] to 01 to set VLD and LD, respectively.

Procedures:

- (1) Remove four truss head screws that hold the (upper and lower) brackets provided by factory configuration.
- (2) Change the position of the screw holes for the (upper and lower) brackets.
- (3) Tighten the (upper and lower) brackets using four truss head screws removed in (1). (Tightening torque 2.2 to 2.5 N·m)
- (4) Install P1-00600-L (P1-110L) on the wall using four screws prepared on your own.

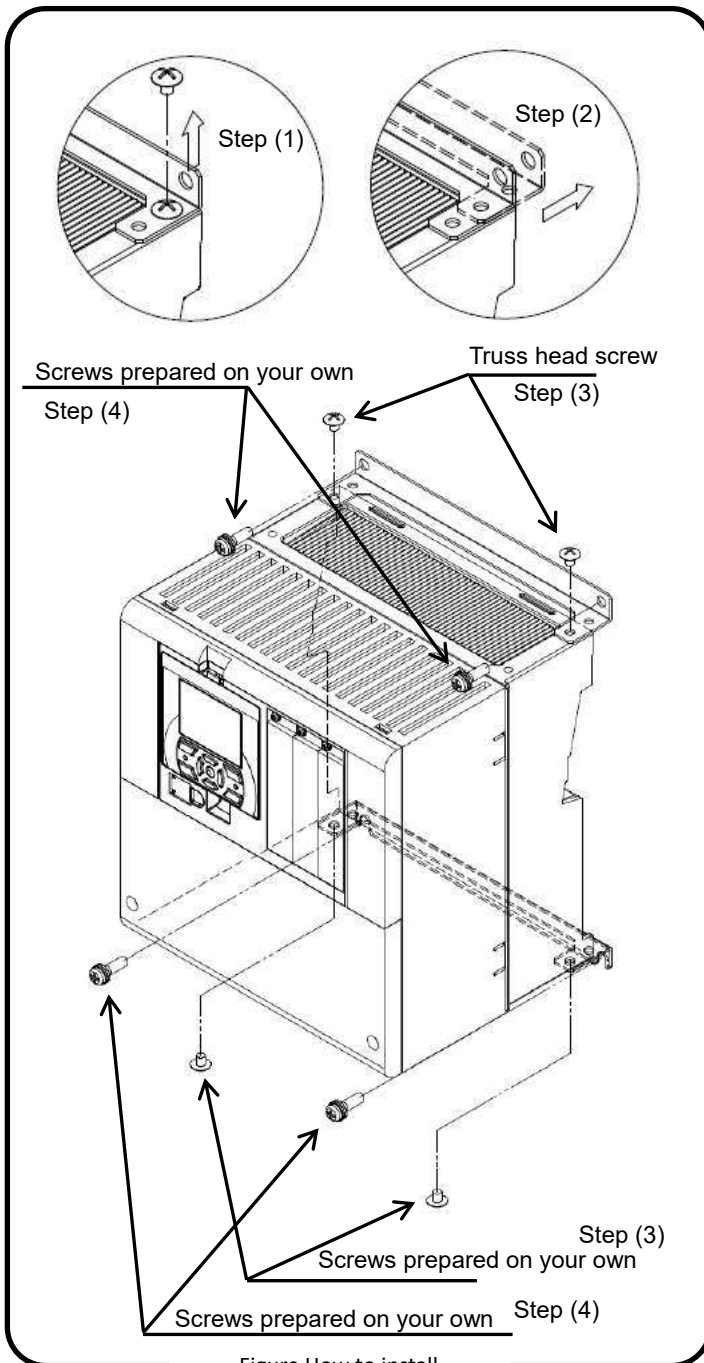

Figure How to install

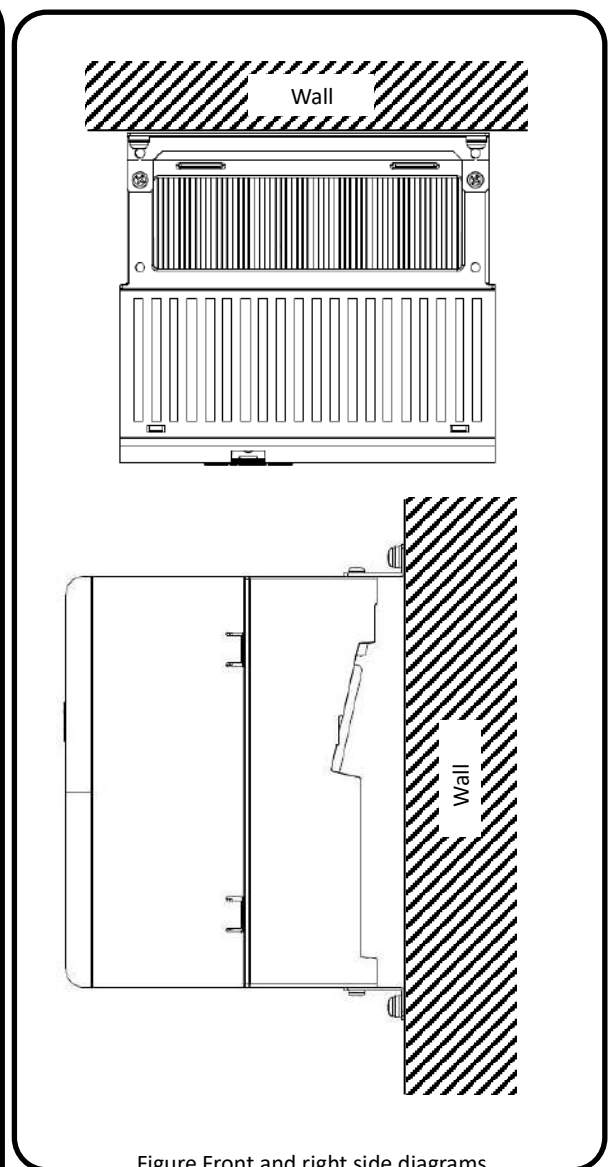

Figure Front and right side diagrams

※Note

By shifting the mounting bracket, the depth dimensions of the inverter increase by 15 mm. Please check for any problems when installing the inverter in the cabinet or etc.

◆ Notes for P1-01240-L (P1-220L)



For the use of P1-01240-L(P1-220L) at very low duty (VLD), follow the installation procedures shown in the figure below.

Change [Ub-03] to 00 to set VLD.

Procedures:

- (1) Tighten (four) spacers to the (upper and lower) brackets as shown in figure below, using bundled (four) M3 x 8 screws in the package. (Tightening torque 0.6 to 0.8 N·m)
- (2) Install P1-01240-L(P1-220L) on the wall using four screws prepared on your own.

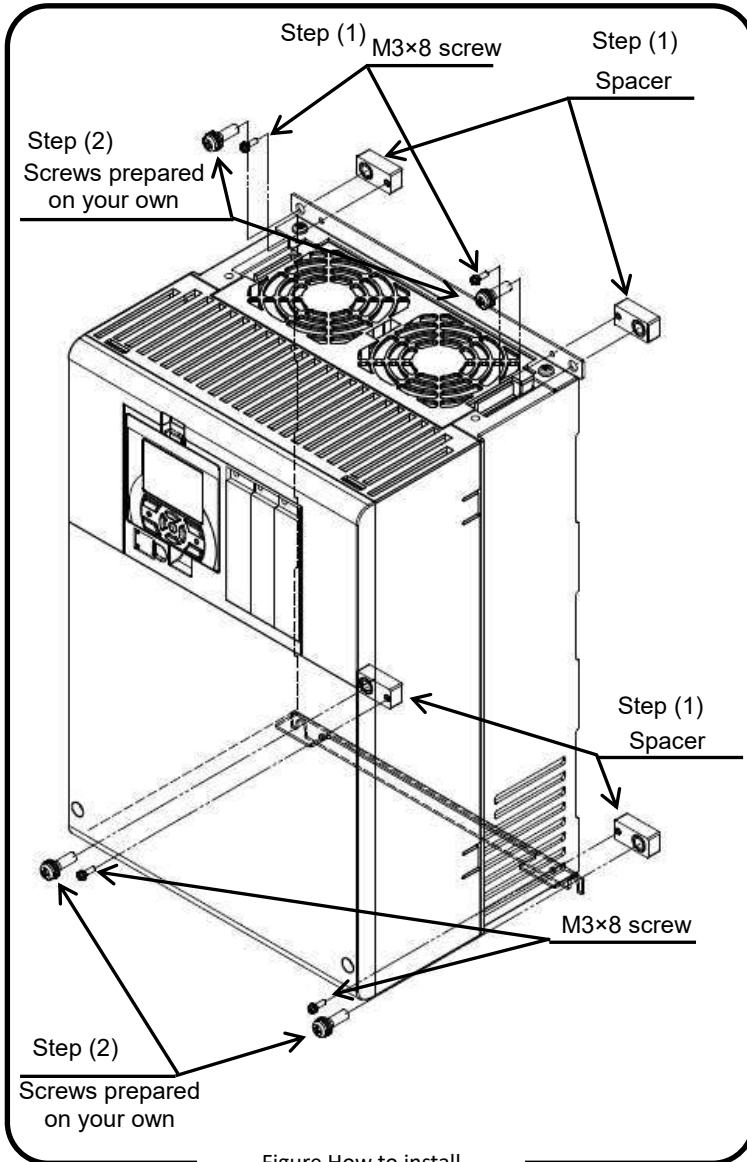

Figure How to install

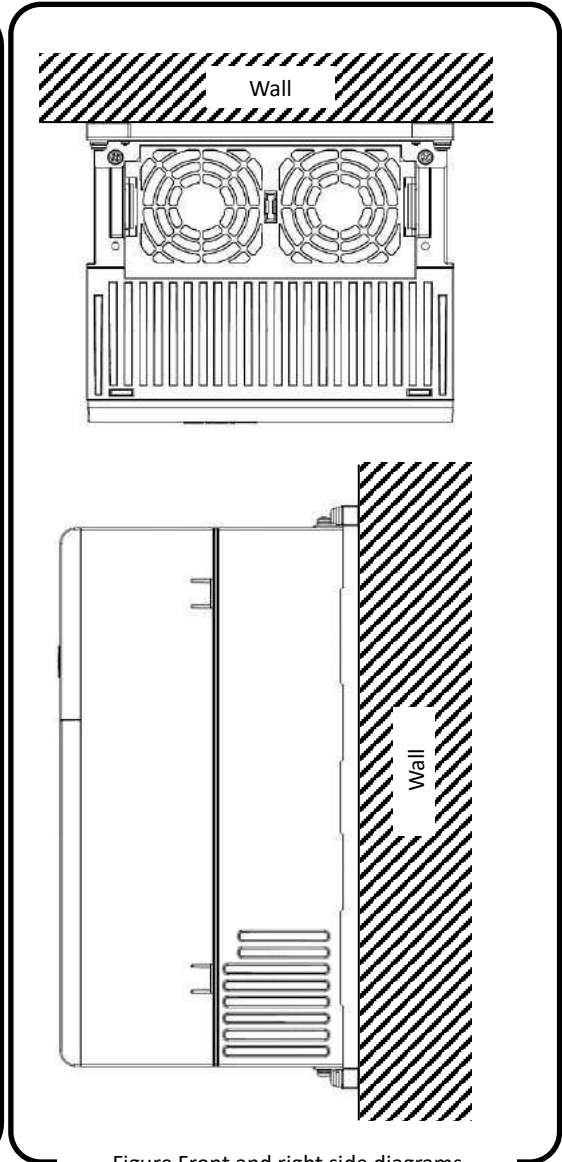

Figure Front and right side diagrams





※Note

By adding spacers, the depth dimensions of the inverter increase by 10 mm. Please check for any problems when installing the inverter in the cabinet or etc.

# Chapter 2 Installation and Wiring

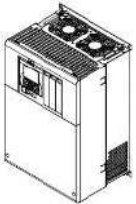
## 2.1 Check the Inverter

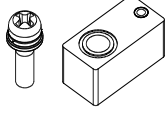
Check the contents in the package, and confirm the inverter model with a specification label.

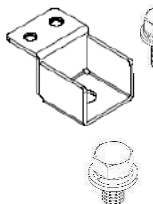
 <p><b>Inverter</b></p>	 <p>Basic Guide (This document) And other supplementary instructions.</p>	<p>Enclosed in the P1-01240-L (P1-220L)</p>  <p>M3x8 screws : 4 pcs Spacer : 4 pcs</p>	<p>Enclosed in the P1-01850-L(P1-370L)/ P1-00930-H(P1-370H) or above.</p>  <p>Eye bolts for hanging the inverter</p>	<p>Enclosed in the P1-03720-H(P1-1600H) to P1-05500-H(P1-2500H). (For P1-06600-H(P1-3150H), bundled only the bolts for the ground terminal. See page 2-4 for details.)</p>  <ul style="list-style-type: none"> <li>Supplemental terminal for braking unit connection (the shape differs depending on the model) and bolts for it. 1 pcs , M8x20 bolt : 2 pcs</li> <li>Bolts for the ground terminal M12x20 bolt : 2 pcs</li> </ul>
--	--	---	---	--

[The model of the product is as follows]

E.g.: 200V class input voltage for Japan

Applicable motor capacity for ND rating is 3.7 kW  
ND rated current 17.5A  
LD rated current 19.6A  
VLD rated current 22.8A

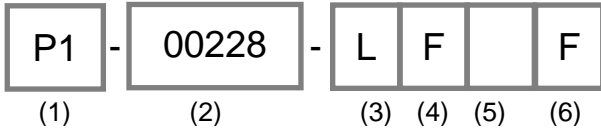

- (1) Type name P1
- (2) Motor maximum rated current (at VLD rated current 00001: 0.1A to 99999: 9999.9A)
- (3) Input power specification  
L: three-phase 200V class; H: three-phase 400V class
- (4) Panel  
B: no operator keypad equipped;  
F: panel equipped
- (5) Region :  
(None): Japan; Europe/Southeast Asia; U: North America; C: China  
◇ In case of (None), blank field is omitted.
- (6) Integrated noise filter  
F: integrated noise filter equipped;  
CB: conduit box equipped  
◇ When both F and CB are equipped, it is indicated as FCB.

• **Specification label example**

Description example for P1-00228-LFF  
(\* ) means eigenvalues

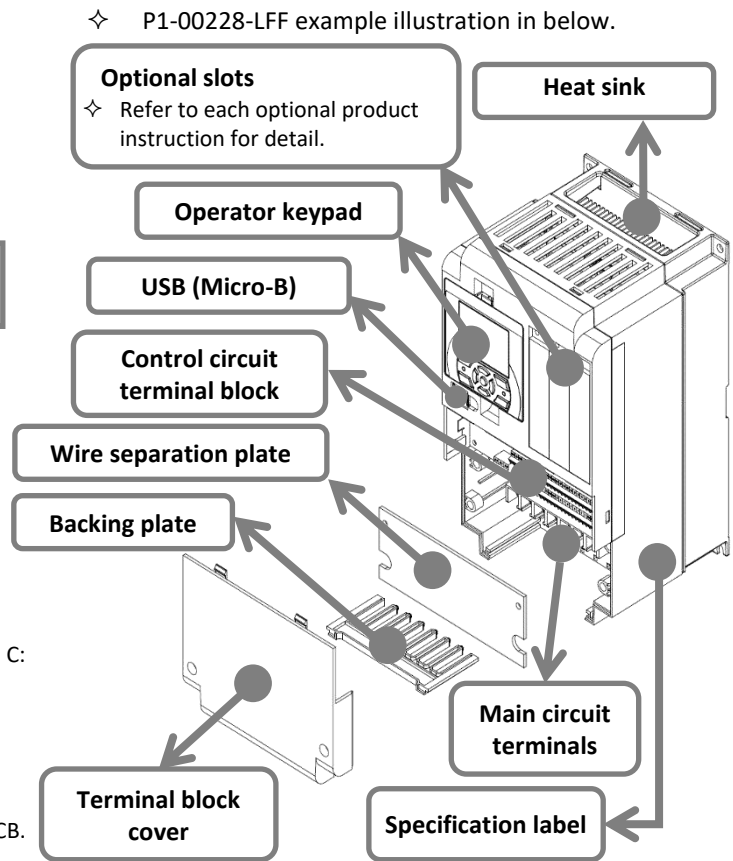
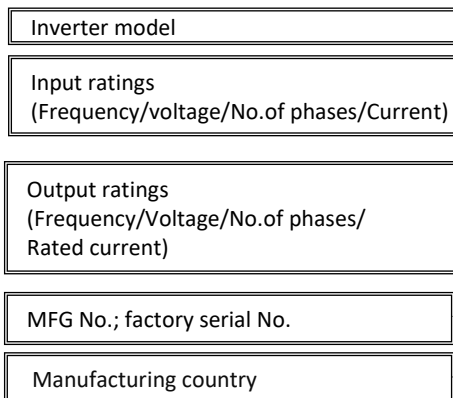

5.5 / 5.5 / 3.7 (Reference applicable motor(kW))

<b>HITACHI</b> INVERTER		Ver.2.02
SJ series type P1		
Model: P1-00228-LFF		
Input/Entrée:50Hz,60Hz 200-240V 3ph 27.1/23.3/20.8A		
Output/Sortie:0-590Hz 200-240V 3ph 22.8/19.6/17.5A		
MFG No. 62AA***** 00001	Date:****	
Hitachi Industrial Equipment Systems Co., Ltd.	MADE IN 0000	NE18361-***

\* Input and output currents are listed as UL certified current values.  
Versions due to differences in firmware etc. are displayed. For an overview of differences by version refer to the Appendix of this guide.

2.2 Install the Inverter

**!** Transportation

- The inverter is made of plastics component. When carrying the inverter, handle it carefully to prevent the parts from damaging.
- Do not carry the inverter by holding the front or terminal block cover. Doing so may cause the inverter to fall.
- Do not install and operate the inverter if it is damaged or its parts are missing.

**!** Ambient temperature

- Avoid installing the inverter in a place where the ambient temperature goes above or below the allowable range defined by the standard inverter specification.

Ambient temperature:

- ND rated : -10 to 50°C
- LD rated : -10 to 45°C
- VLD rated : -10 to 40°C

- Keep sufficient space around the inverter. Measure the temperature in a position about 5 cm distant from the bottom-center point of the inverter, and check that the measured temperature is within the allowable range. Operating the inverter at a temperature outside this range will shorten the inverter life (especially the electrolytic capacitor life), resulting in damage to the inverter.

**!** Do not install on a high temperature, high humidity or easily condensation area

- Avoid installing the inverter in a place where the relative humidity goes above or below the range (20% to 90% RH), as defined by the standard inverter specification. Avoid a place where the inverter is subject to condensation.
- Condensation inside the inverter will result in short circuits, which may cause damage to the inverter. Also avoid places where the inverter is exposed to direct sunlight.

**!** Install inverter on nonflammable (e.g. metal) surface.

- The inverter will reach a high temperature (up to about 150°C) during operation. Install the inverter on a vertical wall surface made of nonflammable material (e.g., metal) to avoid the risk of fire.
- In particular, keep sufficient distance between the inverter and other heat sources (e.g., braking resistors and reactors) if they are installed in the vicinity.

For P1-00044-L to P1-02950-L (P1-004L to P1-550L) or P1-00041-H to P1-01470-H (P1-007H to P1-550H)

For P1-01760-H to P1-06600-H (P1-750H to P1-3150H)

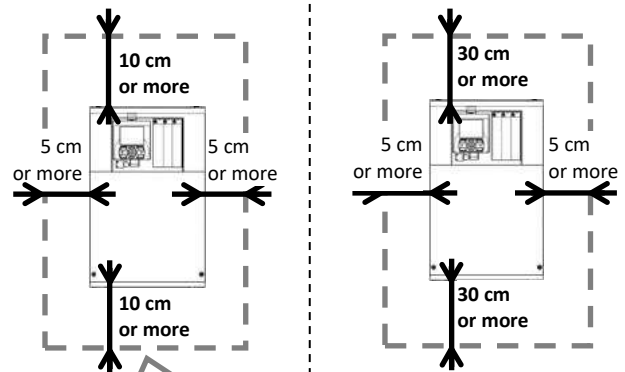

- ✧ In order to replace the life cycle parts in following models, a clearance of at least 22 cm is required at the bottom of the inverter:
  - P1-00800-L (P1-150L) to P1-01240-L (P1-220L)
  - P1-00380-H (P1-150H) to P1-00620-H (P1-220H)
- ✧ In order to replace the life cycle parts in following models, it is required to remove the installed units:
  - P1-00044-L (P1-004L) to P1-00600-L (P1-110L)
  - P1-00041-H (P1-007H) to P1-00310-H (P1-110H)

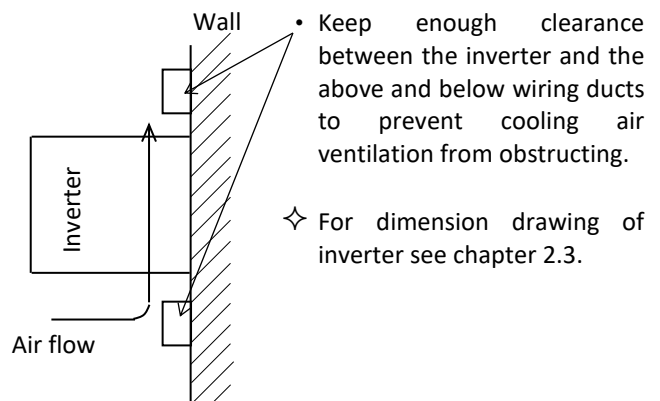

- Keep enough clearance between the inverter and the above and below wiring ducts to prevent cooling air ventilation from obstructing.
- ✧ For dimension drawing of inverter see chapter 2.3.

**! Installation environment**

- Avoid installing the inverter in a place where the inverter is subject to dust, corrosive gases, explosive gases, flammable gases, grinding fluid mist, or salt water.
- Foreign particles entering the inverter will be the cause of failure. If you use the inverter in a considerably dusty environment, install the inverter inside a totally enclosure.

**! Installation method and position**

- Install the inverter vertically and securely with screws or bolts on a surface that is free from vibrations and that can bear the inverter weight.
- If the inverter is not installed properly, its cooling performance may be degraded and tripping or inverter damage may result.

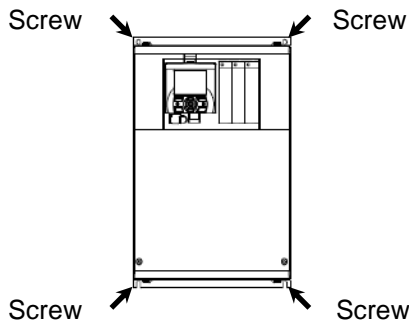

**! Mounting in an enclosure**

- When mounting multiple inverters in an enclosure with a ventilation fan, carefully design the layout of the ventilation fan, air intake port, and inverters. An inappropriate layout will reduce the inverter-cooling effect and raise the ambient temperature. Plan the layout properly so that the inverter ambient temperature will remain within the range specified in the specification table.

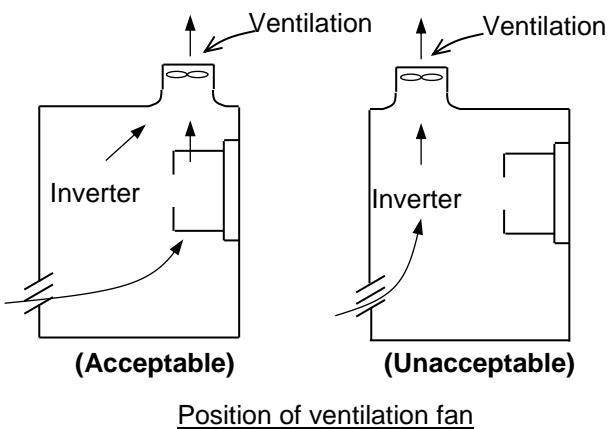

- ◇ When the inverter is installed below ventilation fan, the incoming dust may adhere to the inverter. Place in a position to avoid this falling dust.

**! Reduction of enclosure size**

- External heat sink installation may reduce internal heat emission and reduce the enclosure size.
- External heat sink mounting for the inverter P1-00044-L to P1-00228-L (P1-004L to P1-037L) and P1-00041-H to P1-00126-H (P1-007H to P1-037H) requires an optional metal fitting.
- Models other than the above can be mounted using the brackets attached on the inverter. When mounting the inverter with the heatsink outside the enclosure, cut the mounting surface depending on the panel cut dimensions.
- The cooling section (including the heat sink) positioned outside the enclosure has a cooling fan. Therefore, do not place the enclosure in any environment where it is exposed to water drops, oil mist, or dust.
- The heat sink part reaches a high temperature. Install a protection cover as needed.

■ Watt loss (W) (at 100% load, approximate)

\*200V class

P1-****-L	00044	00080	00104	00156	00228	00330	00460	00600
P1-***L	004	007	015	022	037	055	075	110
Watt loss (W)	ND	50	65	93	142	225	348	498
	LD	53	80	118	162	253	365	400
	VLD	65	105	135	197	314	420	520

P1-****-L	00800	00930	01240	01530	01850	02290	02950
P1-***L	150	185	220	300	370	450	550
Watt loss (W)	ND	742	964	1163	1317	1534	1625
	LD	922	1167	1263	1536	1801	1940
	VLD	1059	1332	1377	1698	2092	2300

\*400V class

P1-****-H	00041	00054	00083	00126	00175	00250	00310	00400
P1-***H	007	015	022	037	055	075	110	150
Watt loss (W)	ND	62	94	96	145	235	240	361
	LD	67	98	107	163	260	280	444
	VLD	76	104	134	189	290	306	482

P1-****-H	00470	00620	00770	00930	01160	01470	01760	02130
P1-***H	185	220	300	370	450	550	750	900
Watt loss (W)	ND	495	687	783	812	1047	1130	2034
	LD	601	805	854	880	1218	1488	2150
	VLD	633	860	920	971	1300	1592	2020

P1-****-H	02520	03160	03720	04320	04860	05200	05500	06600
P1-***H	1100	1320	1600	1850	2000	2200	2500	3150
Watt loss (W)	ND	2219	3872	3896	4091	4514	4710	7545
	LD	2397	4352	4379	4598	4622	5251	6250
	VLD	2557	4598	4627	4858	5533	5689	—

(Note: These data are reference values of our site and vary depending on the power supply environment and the motor power factor.)

**!** Procedure to hang an inverter  
 When lifting the inverter,  
 Please lift according to the figure below

(1) Vertical Slinging.

When lifting vertically, fasten the supplied lifting bolts on the top left and right. Use an appropriate sling tool to achieve an appropriate swing angle in order to maintain sufficient load capacity considering the weight of the inverter.  
 (P1-01850-L(P1-370L) to P1-02950-L(P1-550L) / P1-00930-H(P1-370H) to P1-06600-H(P1-3150H))

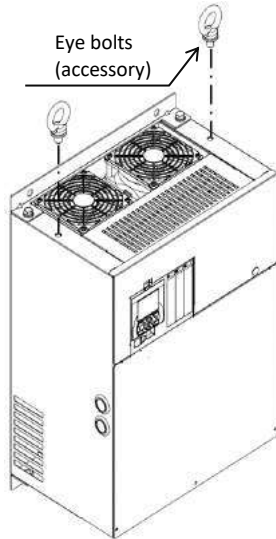

(2) Horizontal Slinging.

(P1-03720-H(1600H) to P1-06600-H(3150H))  
 Shift the pre-fixed eyebolts ① and ② to front cover side and screw tightly.  
 Fix the bundled eyebolts ③ and ④ to the front cover side at 2 points on the lower side and screw tightly.

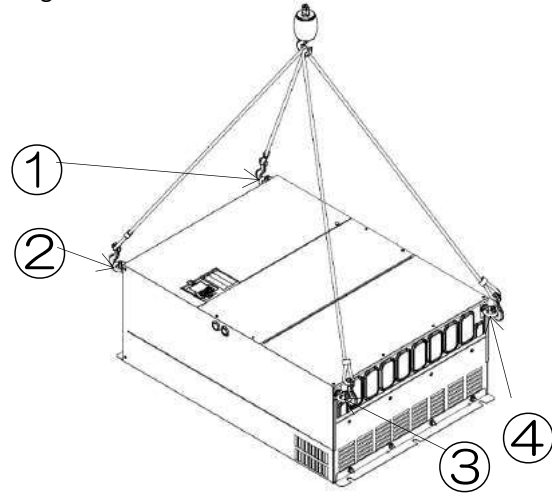

**!** For models of 400V160kW or more, refer to the following when using both the DC link choke for power factor correction and braking unit.

- When using both the DC link choke for power factor correction and the braking unit, remove short bar between PD-P. Then connect to the P terminal the supplemental terminal for the braking unit connection(\*1), and over it connect the DC link choke wire as shown in the picture. After, connect the braking unit P terminal wire (\*2) to the M8 terminals of supplemental terminal. Be sure to use the bundled M8 bolts for the braking unit connection.
  - With P1-06600-H (P1-3150H) model, the supplemental terminal for the braking unit connection is not bundled. For any inquiries about wiring, please contact your supplier or local Hitachi sales office.
  - In case the ground terminals doesn't have any bolt connected to them, use the bundled M12 bolts for the ground connection and make sure to fix them tightly.
- (\*1) The shapes of "supplemental terminal for braking unit connection" varies depending on the model.  
 (\*2) In this case, consider the wire size depending on the customer system referring to page 2-11.

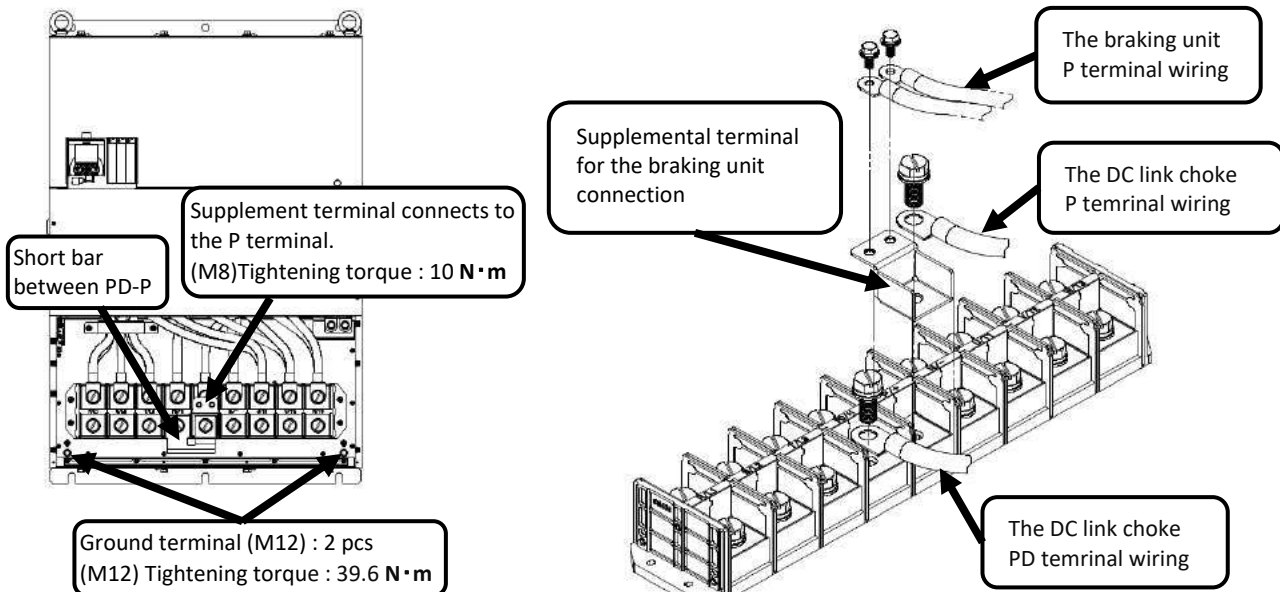



2.3 Dimensions

✧ If you add optional parts to the inverter, some extra space is required in the direction of the depth of the inverter depending on the wiring layout. Keep a clearance of 50 mm or more. For details, refer to the instruction guide for each optional product.

Model P1-***** (P1-****)			
200V class: 00044-L(004L), 00080-L(007L), 0104-L(015L), 00156-L(022L), 00228-L(037L)			
400V class: 00041-H(007H), 00054-H(015H), 00083-H(022H), 00126-H(037H)			
Dimension	W(mm)	H(mm)	D(mm)
	150	255	140

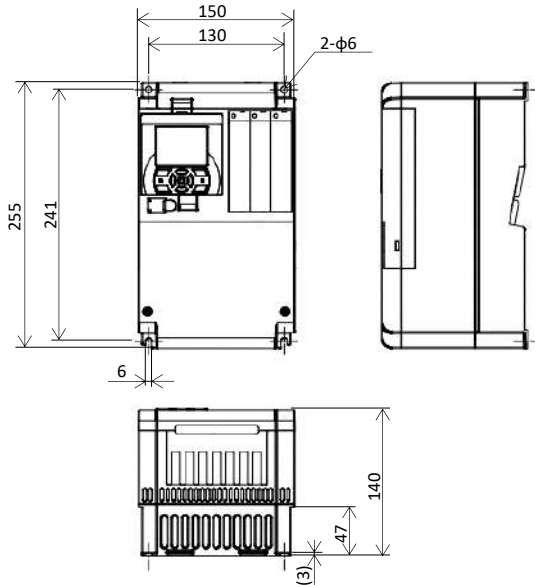

Model P1-***** (P1-****)			
200V class: 00330-L(055L), 00460-L(075L), 00600-L(110L)			
400V class: 00175-H(055H), 00250-H(075H), 00310-H(110H)			
Dimension	W(mm)	H(mm)	D(mm)
	210	260	170

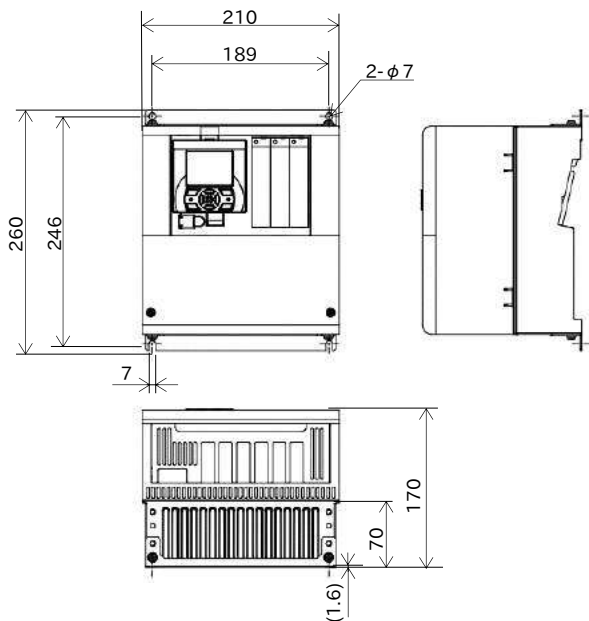

(Eg.) See "Chapter 7 Specifications" for details. VLD rated current for 00044-L(004L) is 4.4A, (ND rated motor capacity is 0.4kW), and L indicates 200V class, while H indicates 400V class.

Model P1-***** (P1-****)			
200V class: 00800-L(150L), 00930-L(185L), 01240-L(220L)			
400V class: 00400-H(150H), 00470-H(185H), 00620-H(220H)			
Dimension	W(mm)	H(mm)	D(mm)
	245	390	190

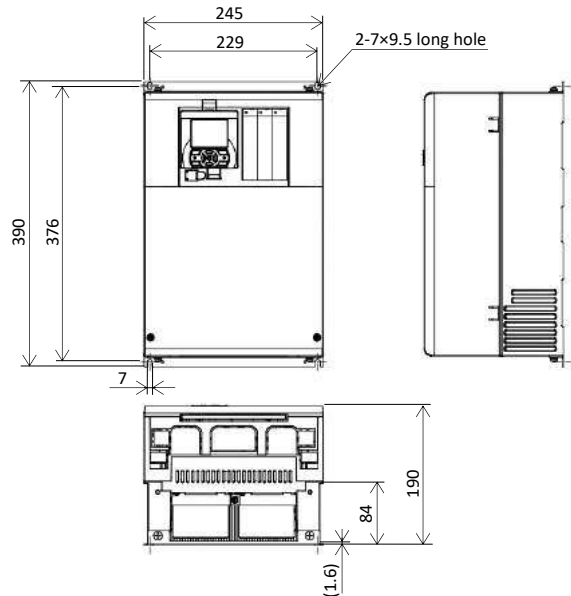

Model P1-***** (P1-****)			
200V class: 01530-L(300L)			
400V class: 00770-H(300H)			
Dimension	W(mm)	H(mm)	D(mm)
	300	540	195

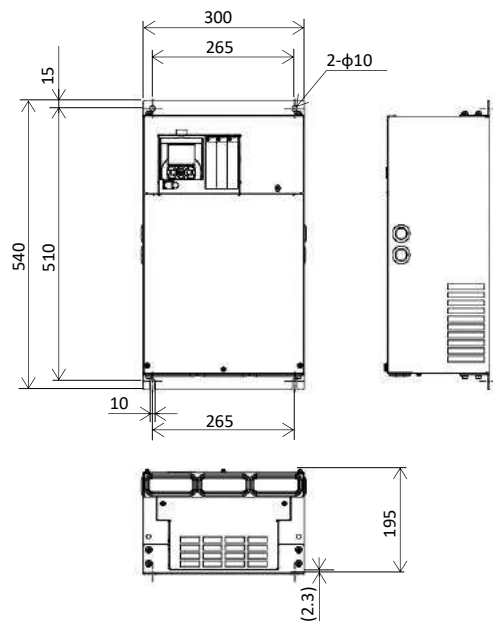

<b>Model P1-***** (P1-****)</b>			
200V class: 01850-L(370L), 02290-L(450L), 400V class: 00930-H(370H),01160-H(450H),01470-H(550H)			
Dimension	W(mm)	H(mm)	D(mm)
	390	550	250

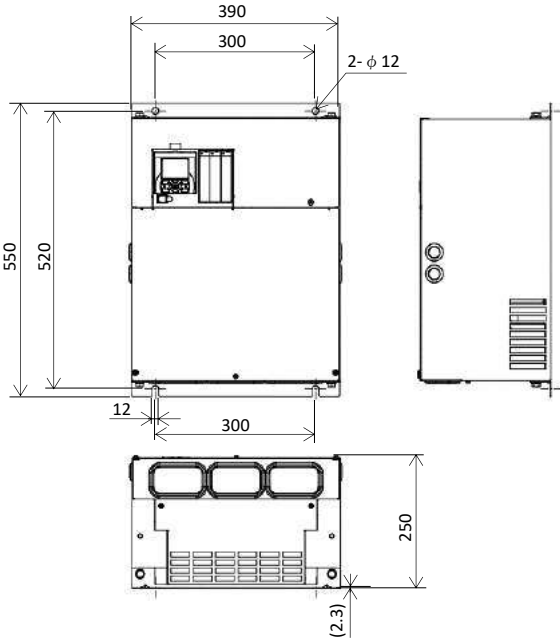

<b>Model P1-***** (P1-****)</b>			
400V class: 01760-H(750H), 02130-H(900H)			
Dimension	W(mm)	H(mm)	D(mm)
	390	700	270

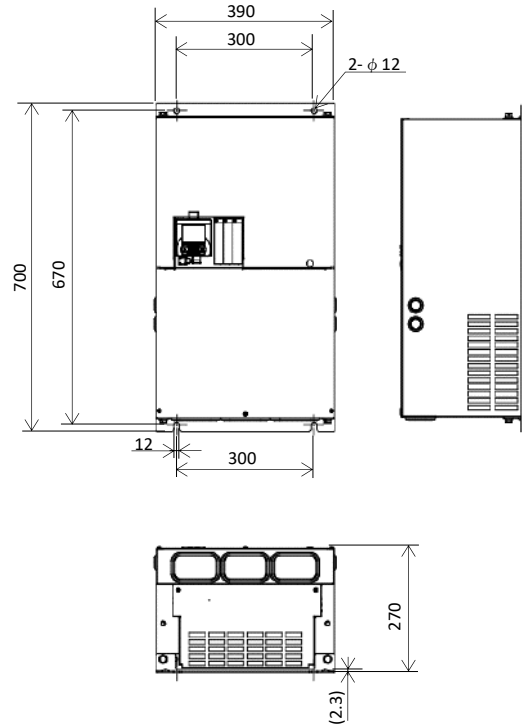

<b>Model P1-***** (P1-****)</b>			
200V class: 02950-L(550L)			
Dimension	W(mm)	H(mm)	D(mm)
	480	700	250

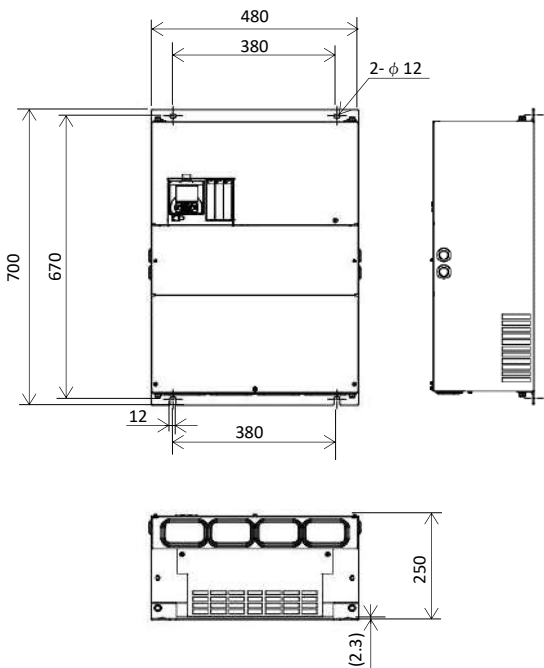

<b>Model P1-***** (P1-****)</b>			
400V class: 02520-H(1100H), 03160-H(1320H)			
Dimension	W(mm)	H(mm)	D(mm)
	480	740	270

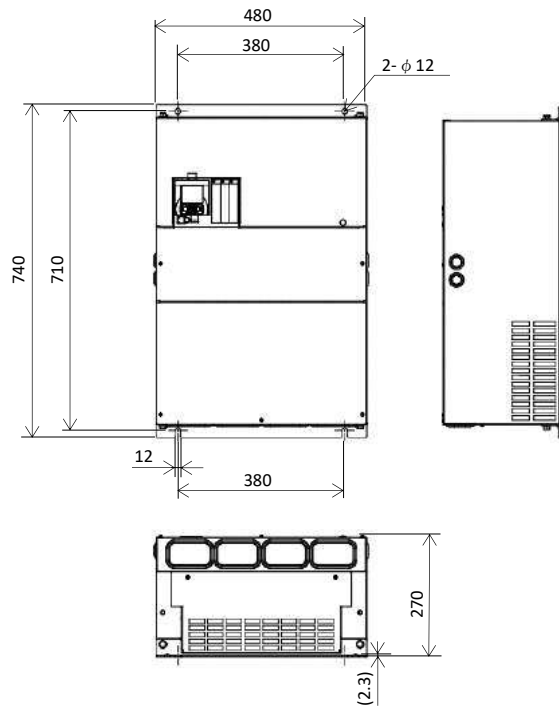

<b>Model P1-***** (P1-*****)</b>			
400V class: 03720-H(1600H)			
Dimension	W(mm)	H(mm)	D(mm)
	480	995	370

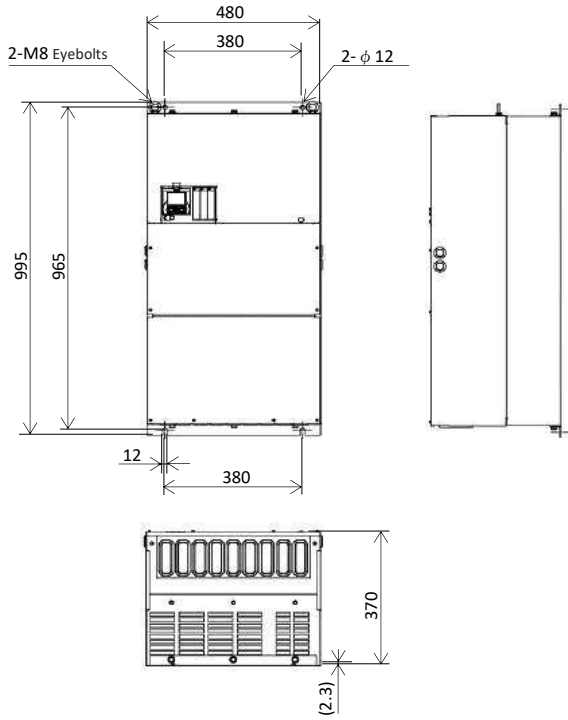

<b>Model P1-***** (P1-*****)</b>			
400V class: 04860-H(2000H), 05200-H(2200H), 05500-H(2500H)			
Dimension	W(mm)	H(mm)	D(mm)
	680	995	370

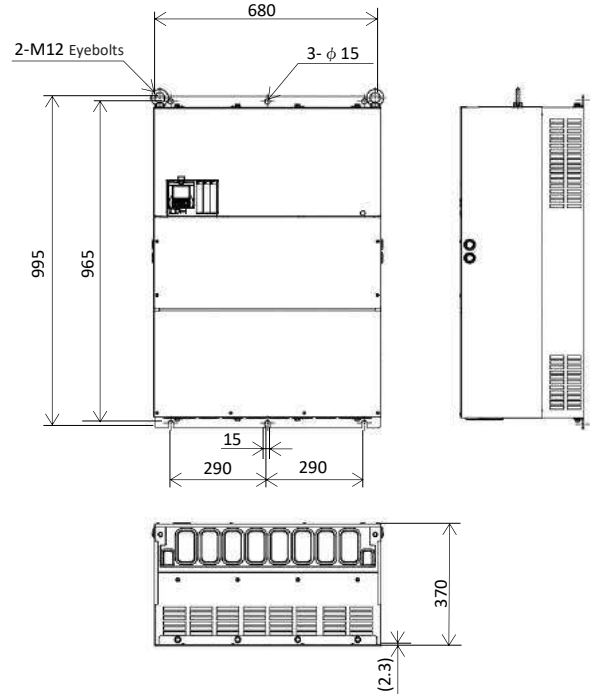

<b>Model P1-***** (P1-*****)</b>			
400V class: 04320-H(1850H)			
Dimension	W(mm)	H(mm)	D(mm)
	680	995	370

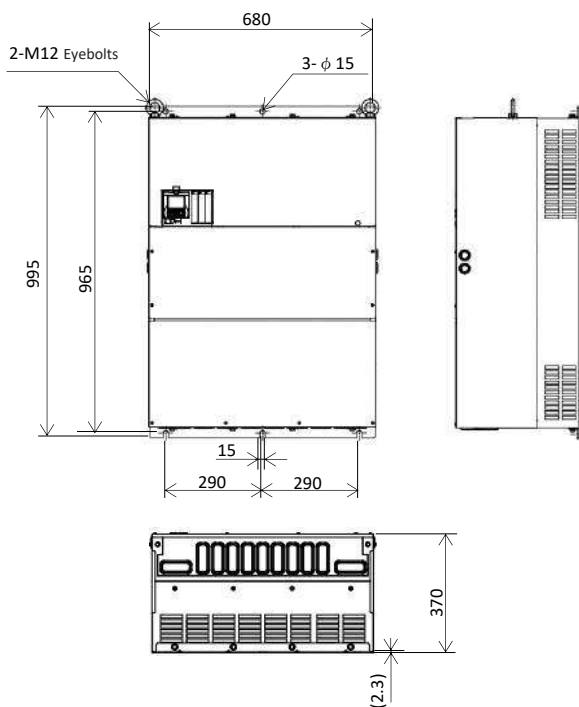

<b>Model P1-***** (P1-*****)</b>			
400V class: 06600-H(3150H)			
Dimension	W(mm)	H(mm)	D(mm)
	580	1200	450

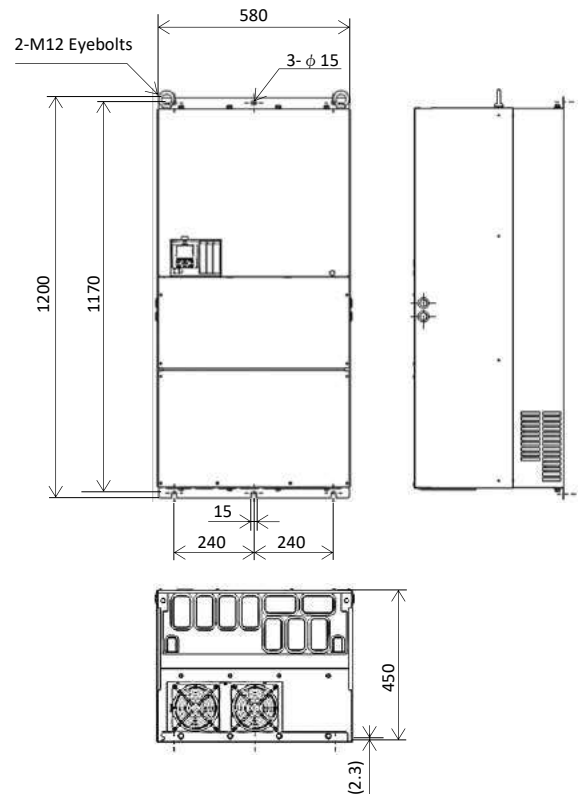

2.4 Inverter Wiring

Applicable peripheral equipment



Notes:

- The description of peripheral equipment is for Hitachi 3-phase, 4-pole squirrel-cage motor.
- Select breakers with proper interrupting capacity. (Use inverter-ready breakers)
- Use earth-leakage circuit breakers (ELB or MCB) to ensure safety.
- Use copper electric wire (HIV cable) with allowable temperature rating 75°C or more.
- If the power line exceeds 20 m, use cable with major wire size for the power line.
- Tighten each terminal screw with the specified tightening torque.  
Loose terminal screws may cause short circuits and fire.  
Excessive tightening torque may cause damage to the terminal block or inverter body.
- When selecting a rated sensitivity current for earth-leakage circuit breaker, use a separated breaker considering a total cable length of between Inverter-Power supply and Inverter-Motor distance. Do not use a high-speed type of earth-leakage circuit breaker. Use an inverter-ready breaker, because the high-speed type may malfunction.
- When using a CV cable for wiring through a metal conduit, the average current leakage would be 30mA/km.
- When using a high relative dielectric constant cable such as IV cable, the leakage current is about eight times as high as the standard cable. Therefore, when using an IV cable, use Earth-leakage circuit breaker (ELB) with rated sensitivity current by eight times higher in the table below. If the total cable length exceeds 100 m, use a CV cable.
- Do not pull the power line cable after wiring. Doing so may cause screw loosening.
- The inverter of 160kW (P1-1600H) or more, be sure to use a reactor (DCL or ALI) for power factor correction. (Normally, use DCL )

Total cable length	Sensitivity current (mA)
100 m or less	50
300 m or less	100

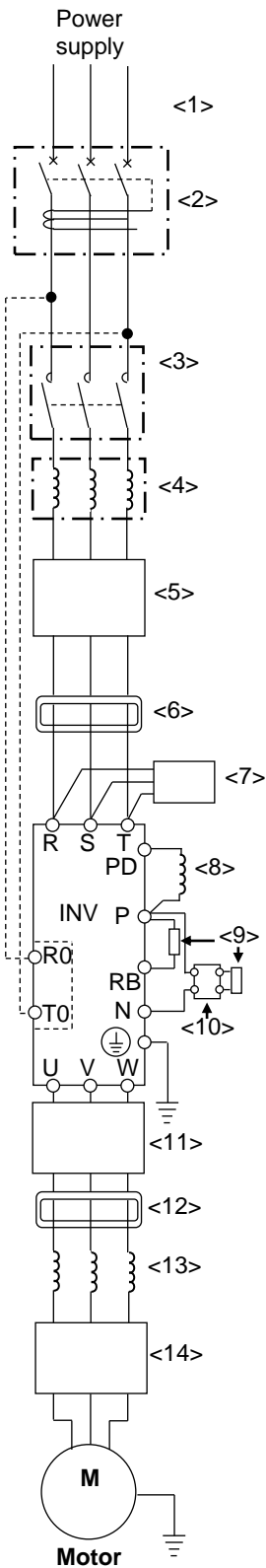

No.	Name	Function
<1>	Electric wire	See "Recommended wire size, wiring accessories and crimp terminals" on Chapter 2.6.
<2>	Earth-leakage circuit breaker ELB or MCCB	
<3>	Magnetic contactor MC	
<4>	Input side AC reactor (For harmonic control, power supply coordination, and power factor correction) (ALI-****)	Use input reactor for harmonic wave control, or when power supply voltage imbalance exceeds 3% or more, or when the power supply capacity is over 500 kVA or more, or when the power voltage may change rapidly. This reactor also improves the power factor.
<5>	Noise filter for inverter	This noise filter reduces the conductive noise that is generated by the inverter and transmitted in cables. Connect this noise filter to the primary side (input side) of the inverter.
<6>	Radio noise filter (Zero-phase reactor) (ZCL-**)	The inverter may generate radio noise through power supply wiring during operation. Use this noise filter to reduce the radio noise (radiant noise).
<7>	Radio noise filter on the input side (Capacitor filter)	Use this noise filter to reduce the radiant noise radiated from input cables.
<8>	DC link Choke ( DCL-***)	Use DC link chokes to reduce the harmonic generated by the inverter. This reactor also improves the power factor.
<9>	Braking resistor	Use these devices to increase the braking torque of the inverter for operation in which the inverter turns the connected load on and off very frequently or decelerates the load running with a high moment of inertia.
<10>	Regenerative braking unit ( BRD-***)	
<11>	Noise filter on the output side	Connect this noise filter between the inverter and motor to reduce the radiant noise radiated from cables for the purpose of reducing the electromagnetic interference with radio and television reception and preventing malfunctions of measuring equipment and sensors.
<12>	Radio noise filter (Zero-phase reactor) (ZCL-**)	Use this noise filter to reduce the noise generated on the output side of the inverter. (This noise filter can be used on both the input and output sides.)
<13>	Output side AC reactor(ACL-****) (For reducing vibrations and preventing thermal relay malfunction)	Inverter driven motor may cause large vibrations compared to commercial power supply direct start motor. Connect Output AC reactor between inverter and motor to lessen the pulsation of motor. Also, connect output AC reactor, when the cable length between inverter and motor is longer (10 m or more), to prevent thermal relay malfunction due to the harmonic waves generated by switching operation of inverter. Note that the thermal relay can be replaced with a current sensor to avoid the malfunction.
<14>	LCR filter	Connect this noise filter between the inverter and motor to convert the inverter output into a sinusoidal waveform and to reduce the motor vibration, motor noise and the radiant noise radiated from cables. Surge voltage can be also controlled.

### 2.5 Wiring of the main circuit

Wire the main circuit of the inverter.  
 The following illustration shows the power supply and wiring connections to a motor only.  
 Open a terminal block cover to wire the terminal block in the main circuit.

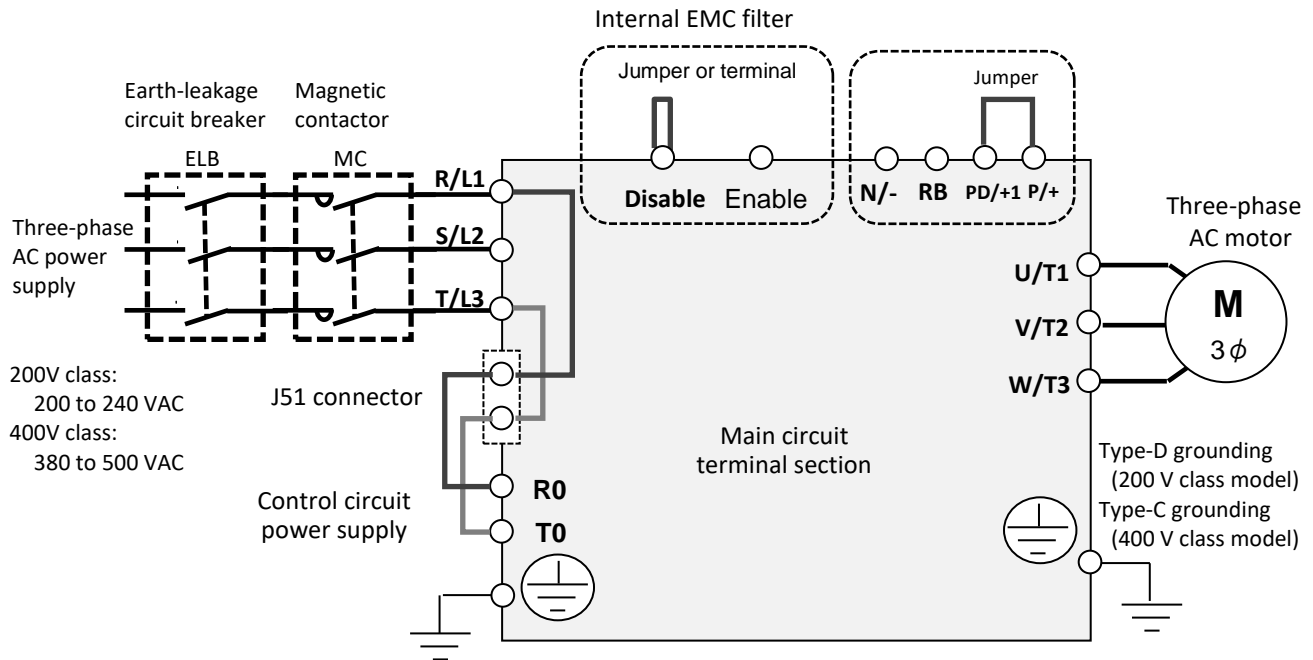

#### Explanation of main circuit terminal block

Symbol	Terminal name	Description
R,S,T (L1,L2,L3)	Main power input	Connect to the AC power supply. Leave these terminals unconnected when using a regenerative converter.
U,V,W (T1,T2,T3)	Inverter output	Connect a Three-phase motor.
PD,P (+1,+)	DC link choke connection terminal	Remove the PD-P jumper from terminals, and connect the optional DC link choke ( Ex ) HITACHI Model is DCL-*** ) for power factor improvement.
P,RB (+,RB)	External chopper braking resistor connection terminal	Connect the optional external braking resistor. See "Chapter 7 Specifications" for built-in braking circuit inverter models.
P,N (+,-)	Regenerative braking unit connection terminal	Connect the optional regenerative braking unit.
⊕	Inverter ground terminal	This serves as a ground terminal for the inverter chassis to ground. Connect 200V class and 400V class models to Type-D grounding and Type-C grounding, respectively.

- ✧ See "Chapter 1 Safety Instructions" for response to CE and UL standards.
- ✧ If export to the U.S. or Canada or compliance with UL/cUL standards is required, wires and breakers described in UL / cUL should be used. When connecting wires to the main circuit terminal block, use a round crimping terminal (UL-certified item) suitable for the wires for use. Use a crimp tool recommended by the manufacturer of the crimping terminal to crimp the terminal.
- ✧ The screw size may vary depending on terminal. Refer to Chapter 2.6 for the size of the terminal screw for the power line cable while for other terminals, refer to the drawings of the wiring on Chapter 2.9.
- ✧ The tables on Chapter 2.6 list the specifications of cables, crimp terminals, and terminal screw tightening torques for reference.
- ✧ Recommended wire size vary depending on the rated load settings (ND/LD/VLD).
- ✧ The wire diameters shown in tables in Chapter 2.6 Wire Diameter, Wiring Tools, and Crimping Terminals" indicate design values for HIV wire (resistant to 75°C heat).
- ✧ When connecting wires to the main circuit terminal block, use a round crimping terminal in accordance with the wires for use. Use a crimp tool recommended by the manufacturer of the crimping terminal to crimp the terminal.
- ✧ When replacing from SJ700 to P1, if the wire diameter is different, etc, Please contact your supplier or local Hitachi inverter sales office, refer to page S-3.

## 2.6 Recommended wire size, wiring accessories and crimp terminals

■ 200V class

Model P1-***** (P1-****)	Load Type	Power line cable AWG(mm <sup>2</sup> ) R,S,T,U,V,W, P,PD,N	Grounding cable AWG(mm <sup>2</sup> )	External braking resistor between P and RB AWG(mm <sup>2</sup> )	Power line cable Terminal screw size	Crimp terminal Power/Ground	Tightening torque(N·m) Power/Ground (maximum value)
P1-00044-L (P1-004L)	ND	14(2.1)	14(2.1)	14(2.1)	M4	2-4/2-4	1.4/1.4 (1.5/1.5)
	LD						
	VLD						
P1-00080-L (P1-007L)	ND	14(2.1)	14(2.1)	14(2.1)	M4	2-4/2-4	1.4/1.4 (1.5/1.5)
	LD						
	VLD						
P1-00104-L (P1-015L)	ND	14(2.1)	14(2.1)	14(2.1)	M4	2-4/2-4	1.4/1.4 (1.5/1.5)
	LD						
	VLD						
P1-00156-L (P1-022L)	ND	14(2.1)	14(2.1)	14(2.1)	M4	2-4/2-4	1.4/1.4 (1.5/1.5)
	LD						
	VLD	10(5.3)	10(5.3)	10(5.3)	5.5-4/5.5-4		
P1-00228-L (P1-037L)	ND	10(5.3)	10(5.3)	10(5.3)	M4	5.5-4/5.5-4	1.4/1.4 (1.5/1.5)
	LD						
	VLD						
P1-00330-L (P1-055L)	ND	8(8.4)	8(8.4)	8(8.4)	M5	8-5/8-5	3.0/3.0 (3.0/3.0)
	LD						
	VLD						
P1-00460-L (P1-075L)	ND	8(8.4)	6(13.3)	8(8.4)	M5	8-5/8-5	3.0/3.0 (3.0/3.0)
	LD						
	VLD	6(13.3)	6(13.3)	6(13.3)	14-5/8-5		
P1-00600-L (P1-110L)	ND	6(13.3)	6(13.3)	6(13.3)	M6	14-6/14-6	4.0/4.0 (5.2/5.2)
	LD	4(21.2)		4(21.2)		22-6/14-6	
	VLD	4(21.2)		4(21.2)		22-6/14-6	
P1-00800-L (P1-150L)	ND	4(21.2)	6(13.3)	4(21.2)	M6	22-6/14-6	2.5 to 3.0/4.9 (4.1/5.2)
	LD	3(26.7)		3(26.7)		38-6/14-6	
	VLD	3(26.7)		3(26.7)		38-6/14-6	
P1-00930-L (P1-185L)	ND	3(26.7)	6(13.3)	3(26.7)	M6	38-6/14-6	2.5 to 3.0/4.9 (4.1/5.2)
	LD	2(33.6)		2(33.6)		60-6/14-6	
	VLD	1(42.4)		1(42.4)		60-6/14-6	
P1-01240-L (P1-220L)	ND	1(42.4)	6(13.3)	1(42.4)	M8	60-8/14-6	5.5 to 6.6/4.9 (9.0/5.2)
	LD	1/0(53.5)		1/0(53.5)		70-8/14-6	
	VLD	2/0(67.4)		2/0(67.4)		70-8/14-6	
P1-01530-L (P1-300L)	ND	2/0(67.4)	4(21.2)	—	M8	70-8/22-8	6.0/11.7 (9.0/12.5)
	LD	1/0×2(53.5×2)				60-8/22-8	
	VLD						
P1-01850-L (P1-370L)	ND	4/0(107.2)	4(21.2)	—	M8	100-8/22-8	15.0/11.7 (15.0/12.5)
	LD	1/0×2(53.5×2)				60-8/22-8	6.0-10.0/11.7 (12.0/12.5)
	VLD						
P1-02290-L (P1-450L)	ND	1/0×2(53.5×2)	4(21.2)	—	M8	60-8/22-8	6.0 to 10.0/11.7 (12.0/12.5)
	LD	2/0×2(67.4×2)				70-8/22-8	
	VLD						
P1-02950-L (P1-550L)	ND	350kcmil(177)	3(26.7)	—	M10	180-10/38-8	10.0 to 12.0/11.7 (16.5/12.5)
	LD	3/0×2(85.0×2)				80-10/38-8	
	VLD						

◇ The wire size in the above table shows the designed values based on HIV cables (with thermal resistance of 75°C).

◇ When you connect the electric wire with the main circuit terminal block, use the round type crimp terminals (for the UL standard) suitable for the use electric wire. Please put on pressure to the crimp terminals with a crimp tool that the crimp terminal maker recommends.

◇ When applying the UL standard, refer to "1.5 Compliance to UL standards". Tightening torque is recommended "maximum value" in the above table.

■ 400V class

Model P1-***** (P1-****)	Load Type	Power line cable AWG(mm <sup>2</sup> ) R,S,T,U,V,W, P,PD,N	Grounding cable AWG(mm <sup>2</sup> )	External braking resistor between P and RB AWG(mm <sup>2</sup> )	Power line cable Terminal screw size	Crimp terminal Power/Ground	Tightening torque(N·m) Power/Ground (maximum value)
P1-00041-H (P1-007H)	ND/LD/VLD	14(2.1)	14(2.1)	14(2.1)	M4	2-4/2-4	1.4/1.4 (1.5/1.5)
P1-00054-H (P1-015H)	ND/LD/VLD	14(2.1)	14(2.1)	14(2.1)	M4	2-4/2-4	1.4/1.4 (1.5/1.5)
P1-00083-H (P1-022H)	ND/LD/VLD	14(2.1)	14(2.1)	14(2.1)	M4	2-4/2-4	1.4/1.4 (1.5/1.5)
P1-00126-H (P1-037H)	ND/LD	14(2.1)	14(2.1)	14(2.1)	M4	2-4/2-4	1.4/1.4 (1.5/1.5)
	VLD	12(3.3)	12(3.3)	12(3.3)		5.5-4/5.5-4	
P1-00175-H (P1-055H)	ND/LD	12(3.3)	12(3.3)	12(3.3)	M5	5.5-5/5.5-5	3.0/3.0 (3.0/3.0)
	VLD	10(5.3)	10(5.3)	10(5.3)			
P1-00250-H (P1-075H)	ND/LD	10(5.3)	10(5.3)	10(5.3)	M5	5.5-5/5.5-5	3.0/3.0 (3.0/3.0)
	VLD	8(8.4)	8(8.4)	8(8.4)		8-5/8-5	
P1-00310-H (P1-110H)	ND/LD/VLD	8(8.4)	8(8.4)	8(8.4)	M6	8-6/8-6	4.0/4.0 (5.2/5.2)
P1-00400-H (P1-150H)	ND/LD/VLD	8(8.4)	8(8.4)	8(8.4)	M6	8-6/8-6	4.0/4.0 (5.2/5.2)
P1-00470-H (P1-185H)	ND	8(8.4)	8(8.4)	8(8.4)	M6	8-6/8-6	4.0/4.0 (5.2/5.2)
	LD	6(13.3)		6(13.3)		14-6/8-6	
	VLD						
P1-00620-H (P1-220H)	ND	6(13.3)	8(8.4)	6(13.3)	M6	14-6/8-6	4.0/4.0 (5.2/5.2)
	LD	4(21.2)		4(21.2)		22-6/8-6	
	VLD						
P1-00770-H (P1-300H)	ND	3(26.7)	6(13.3)	3(26.7)	M6	38-6/14-6 60-6/14-6	2.5 to 3.0/4.9 (4.1/5.2)
	LD	2(33.6)		2(33.6)			
	VLD	1(42.4)		1(42.4)			
P1-00930-H (P1-370H)	ND/LD/VLD	1(42.4)	6(13.3)	1(42.4)	M8	60-8/14-8	15.0/11.7 (15.0/12.5)
P1-01160-H (P1-450H)	ND	1(42.4)	6(13.3)	-	M8	60-8/14-8	15.0/11.7 (15.0/12.5)
	LD	1/0(53.5)					
	VLD						
P1-01470-H (P1-550H)	ND	1/0(53.5)	4(21.2)	-	M8	60-8/22-8	15.0/11.7 (15.0/12.5) 6.0 to 10.0/11.7 (12.0/12.5)
	LD	2/0(67.4)				70-8/22-8	
	VLD	1/0×2(53.5×2)				60-8/22-8	
P1-01760-H (P1-750H)	ND/LD/VLD	1/0×2(53.5×2)	4(21.2)	-	M10	60-10/22-8	10.0 to 12.0/11.7 (16.5/12.5)
P1-02130-H (P1-900H)	ND/LD	1/0×2(53.5×2)	3(26.7)	-	M10	60-10/38-8	10.0 to 12.0/11.7 (16.5/12.5)
	VLD	2/0×2(67.4×2)				70-10/38-8	
P1-02520-H (P1-1100H)	ND/LD	2/0×2(67.4×2)	1(42.4)	-	M10	70-10/60-8	10.0 to 12.0/11.7 (16.5/12.5)
	VLD	3/0×2(85.0×2)				80-10/60-8	
P1-03160-H (P1-1320H)	ND	3/0×2(85.0×2)	1(42.4)	-	M10	80-10/60-8	10.0 to 12.0/11.7 (16.5/12.5)
	LD	4/0×2(107×2)				100-10/60-8	
	VLD	250kcmil×2 (127×2)				150-10/60-8	
P1-03720-H (P1-1600H)	ND	3/0×2(85.0×2)	2/0(67.4)	-	M12	80-12/70-12	15.5 to 18.5/39.6 (25.5/42.0)
	LD	4/0×2(107×2)				150-12/70-12	
	VLD	250kcmil×2 (127×2)				150-12/70-12	
P1-04320-H (P1-1850H)	ND	250kcmil×2 (127×2)	2/0(67.4)	-	M12	150-12/70-12	15.5 to 18.5/39.6 (25.5/42.0)
	LD	250kcmil×2 (127×2)				150-12/70-12	
	VLD	300kcmil×2 (152×2)				150-12/70-12	
P1-04860-H (P1-2000H)	ND	250kcmil×2 (127×2)	2/0(67.4)	-	M16	150-L16/70-12	37.0/39.6 (55.5/42.0)
	LD	300kcmil×2 (152×2)				150-L16/70-12	
	VLD	350kcmil×2 (177×2)				180-L16/70-12	
P1-05200-H (P1-2200H)	ND	300kcmil×2 (152×2)	2/0(67.4)	-	M16	150-L16/70-12	37.0/39.6 (55.5/42.0)
	LD	350kcmil×2 (177×2)				180-L16/70-12	
	VLD	400kcmil×2 (203×2)				200-L16/70-12	
P1-05500-H (P1-2500H)	ND	400kcmil×2 (203×2)	2/0(67.4)	-	M16	200-L16/70-12	37.0/39.6 (55.5/42.0)
	LD	500kcmil×2 (253×2)				325-L16/70-12	
P1-06600-H (P1-3150H)	ND	500kcmil×2 (253×2)	4/0(107)	-	M16	325-L16/100-12	37.0/39.6 (55.5/42.0)
	LD	600kcmil×2 (304×2)				325-L16/100-12	

- ◇ The wire size in the above table shows the designed values based on HIV cable (with thermal resistance of 75°C).
- ◇ When applying the UL standard, refer to "1.5 Compliance to UL standards". Tightening torque is recommended "maximum value" in the above table.

- ◇ When you connect the electric wire with the main circuit terminal block, use the round type crimp terminals (for the UL standard) suitable for the use electric wire. Please put on pressure to the crimp terminals with a crimp tool that the crimp terminal maker recommends.

2.7 Applicable circuit breaker

■ 200V class

- For ND rating

Model P1-***** (P1-****)	Applicable Motor (kW)	Applicable devices (Input Voltage 200 to 220V)							
		Without reactor (DCL or ALI)				With reactor (DCL or ALI)			
		Earth-leakage breaker (ELB)		Magnetic Contactor (MC)		Earth-leakage breaker (ELB)		Magnetic Contactor (MC)	
		Example model	Rated current(A)	AC-1	AC-3	Example model	Rated current(A)	AC-1	AC-3
P1-00044-L(P1-004L)	0.4	EB-30E	5	HS8	HS8	EB-30E	5	HS8	HS8
P1-00080-L(P1-007L)	0.75	EB-30E	10	HS8	HS8	EB-30E	5	HS8	HS8
P1-00104-L(P1-015L)	1.5	EB-30E	15	HS8	HS8	EB-30E	10	HS8	HS8
P1-00156-L(P1-022L)	2.2	EB-30E	20	HS8	HS8	EB-30E	15	HS8	HS8
P1-00228-L(P1-037L)	3.7	EB-30E	30	HS8	HS20	EB-30E	20	HS8	HS20
P1-00330-L(P1-055L)	5.5	EB-50E	40	HS20	HS25	EB-30E	30	HS8	HS20
P1-00460-L(P1-075L)	7.5	EB-50E	50	HS35	HS35	EB-50E	40	HS20	HS25
P1-00600-L(P1-110L)	11	EB-100E	75	HS50	H65C	EB-100E	60	HS35	HS50
P1-00800-L(P1-150L)	15	EXK125-C	125	H65C	H80C	EB-100E	100	HS50	H65C
P1-00930-L(P1-185L)	18.5	EXK125-C	125	H80C	H100C	EB-100E	100	HS50	H65C
P1-01240-L(P1-220L)	22	EXK225	150	H80C	H125C	EXK125-C	125	H65C	H80C
P1-01530-L(P1-300L)	30	EXK225	200	H125C	H150C	EXK225	150	H80C	H125C
P1-01850-L(P1-370L)	37	RXK250-S	250	H150C	H200C	EXK225	200	H100C	H125C
P1-02290-L(P1-450L)	45	EX400	300	H200C	H250C	EXK225	225	H125C	H150C
P1-02950-L(P1-550L)	55	EX400	400	H200C	H300C	EX400	300	H150C	H250C

- For LD/VLD rating

Model P1-***** (P1-****)	Applicable Motor (kW)	Applicable devices (Input Voltage 200 to 220V)							
		Without reactor (DCL or ALI)				With reactor (DCL or ALI)			
		Earth-leakage breaker (ELB)		Magnetic Contactor (MC)		Earth-leakage breaker (ELB)		Magnetic Contactor (MC)	
		Example model	Rated current(A)	AC-1	AC-3	Example model	Rated current(A)	AC-1	AC-3
P1-00044-L(P1-004L)	0.75	EB-30E	10	HS8	HS8	EB-30E	5	HS8	HS8
P1-00080-L(P1-007L)	1.5	EB-30E	15	HS8	HS8	EB-30E	10	HS8	HS8
P1-00104-L(P1-015L)	2.2	EB-30E	20	HS8	HS8	EB-30E	15	HS8	HS8
P1-00156-L(P1-022L)	3.7	EB-30E	30	HS8	HS20	EB-30E	20	HS8	HS20
P1-00228-L(P1-037L)	5.5	EB-50E	40	HS20	HS25	EB-30E	30	HS8	HS20
P1-00330-L(P1-055L)	7.5	EB-50E	50	HS35	HS35	EB-50E	40	HS20	HS25
P1-00460-L(P1-075L)	11	EB-100E	75	HS50	H65C	EB-100E	60	HS35	HS50
P1-00600-L(P1-110L)	15	EXK125-C	125	H65C	H80C	EB-100E	100	HS50	H65C
P1-00800-L(P1-150L)	18.5	EXK125-C	125	H80C	H100C	EB-100E	100	HS50	H65C
P1-00930-L(P1-185L)	22	EXK225	150	H80C	H125C	EXK125-C	125	H65C	H80C
P1-01240-L(P1-220L)	30	EXK225	200	H125C	H150C	EXK225	150	H80C	H125C
P1-01530-L(P1-300L)	37	RXK250-S	250	H150C	H200C	EXK225	200	H100C	H125C
P1-01850-L(P1-370L)	45	EX400	300	H200C	H250C	EXK225	225	H125C	H150C
P1-02290-L(P1-450L)	55	EX400	400	H200C	H300C	EX400	300	H150C	H250C
P1-02950-L(P1-550L)	75	EX600B	500	H300C	H400C	EX400	400	H200C	H300C

- ◇ If export to the U.S. or Canada or compliance with UL/cUL standards is required, wires and breakers described in UL / cUL should be used. For details, see "1.5 Compliance to UL standards".
- ◇ Device model name on above table shows example selection. The device selection should be made in base on rated current, short circuit current capability and accordance to the local electrical legislation.
- ◇ Applicable motor capacity is based on Hitachi 200 VAC, 60Hz, 4 pole IE3 motor.
- ◇ Refer to the wire gauge table on chapter 2.6 for power line cable.
- ◇ Electrical endurance for AC-1 magnetic contactor is 500000 times, however, for emergency stop in motor operation will be only 25 times.
- ◇ Select AC-3 class magnetic contactor for inverter output for application which has an emergency stop or commercial power line operation.
- ◇ When selecting oversize inverter capacity compare to motor rating, select magnetic contactor according to the inverter capacity



■ 400V class For ND rating

Model P1-***** (P1-****)	Applicable Motor (kW)	Applicable devices (Input Voltage 400 to 440V)							
		Without reactor (DCL or ALI)				With reactor (DCL or ALI)			
		Earth-leakage breaker(ELB)		Magnetic Contactor(MC)		Earth-leakage breaker(ELB)		Magnetic Contactor(MC)	
		Example model	Rated current(A)	AC-1	AC-3	Example model	Rated current(A)	AC-1	AC-3
P1-00041-H(P1-007H)	0.75	EXK60-C	15	HS8	HS8	EXK60-C	15	HS8	HS8
P1-00054-H(P1-015H)	1.5	EXK60-C	15	HS8	HS8	EXK60-C	15	HS8	HS8
P1-00083-H(P1-022H)	2.2	EXK60-C	15	HS8	HS8	EXK60-C	15	HS8	HS8
P1-00126-H(P1-037H)	3.7	EXK60-C	15	HS8	HS10	EXK60-C	15	HS8	HS10
P1-00175-H(P1-055H)	5.5	EXK60-C	20	HS8	HS20	EXK60-C	15	HS8	HS20
P1-00250-H(P1-075H)	7.5	EXK60-C	30	HS8	HS25	EXK60-C	20	HS8	HS25
P1-00310-H(P1-110H)	11	EXK60-C	40	HS20	HS35	EXK60-C	30	HS20	HS35
P1-00400-H(P1-150H)	15	EXK60-C	50	HS25	HS50	EXK60-C	40	HS20	HS35
P1-00470-H(P1-185H)	18.5	EXK125-C	75	HS35	HS50	EXK60-C	50	HS35	HS50
P1-00620-H(P1-220H)	22	EXK125-C	75	HS50	H65C	EXK60-C	60	HS50	H65C
P1-00770-H(P1-300H)	30	EXK125-C	100	HS50	H80C	EXK125-C	75	HS50	H65C
P1-00930-H(P1-370H)	37	EXK125-C	125	H80C	H100C	EXK125-C	100	H65C	H80C
P1-01160-H(P1-450H)	45	EXK225	150	H80C	H125C	EXK125-C	125	H80C	H100C
P1-01470-H(P1-550H)	55	EXK225	200	H100C	H125C	EXK225	150	H100C	H125C
P1-01760-H(P1-750H)	75	RXK250-S	250	H150C	H200C	EXK225	200	H125C	H150C
P1-02130-H(P1-900H)	90	EX400	300	H200C	H250C	EXK225	225	H150C	H250C
P1-02520-H(P1-1100H)	110	EX400	400	H200C	H300C	EX400	300	H200C	H250C
P1-03160-H(P1-1320H)	132	EX600B	500	H250C	H300C	EX400	350	H250C	H300C
P1-03720-H(P1-1600H)	160					RX400B	400	H400C	H400C
P1-04320-H(P1-1850H)	185					RX600B	500	H400C	H600C
P1-04860-H(P1-2000H)	200					RX600B	500	H600C	H600C
P1-05200-H(P1-2200H)	220					RX600B	500	H600C	H600C
P1-05500-H(P1-2500H)	250					RX600B	600	H600C	H600C
P1-06600-H(P1-3150H)	315					RX800B	700	H800C	H800C

• For LD/VLD rating

Model P1-***** (P1-****)	Applicable Motor (kW)	Applicable devices (Input Voltage 400 to 440V)							
		Without reactor (DCL or ALI)				With reactor (DCL or ALI)			
		Earth-leakage breaker(ELB)		Magnetic Contactor(MC)		Earth-leakage breaker(ELB)		Magnetic Contactor(MC)	
		Example model	Rated current(A)	AC-1	AC-3	Example model	Rated current(A)	AC-1	AC-3
P1-00041-H(P1-007H)	1.5	EXK60-C	15	HS8	HS8	EXK60-C	15	HS8	HS8
P1-00054-H(P1-015H)	2.2	EXK60-C	15	HS8	HS8	EXK60-C	15	HS8	HS8
P1-00083-H(P1-022H)	3.7	EXK60-C	15	HS8	HS10	EXK60-C	15	HS8	HS8
P1-00126-H(P1-037H)	5.5	EXK60-C	20	HS8	HS20	EXK60-C	15	HS8	HS20
P1-00175-H(P1-055H)	7.5	EXK60-C	30	HS8	HS25	EXK60-C	20	HS8	HS20
P1-00250-H(P1-075H)	11	EXK60-C	40	HS20	HS35	EXK60-C	30	HS20	HS25
P1-00310-H(P1-110H)	15	EXK60-C	50	HS25	HS50	EXK60-C	40	HS25	HS35
P1-00400-H(P1-150H)	18.5	EXK125-C	75	HS35	HS50	EXK60-C	50	HS35	HS50
P1-00470-H(P1-185H)	22	EXK125-C	75	HS50	H65C	EXK60-C	60	HS50	HS50
P1-00620-H(P1-220H)	30	EXK125-C	100	HS50	H80C	EXK125-C	75	HS50	H65C
P1-00770-H(P1-300H)	37	EXK125-C	125	H80C	H100C	EXK125-C	100	H80C	H80C
P1-00930-H(P1-370H)	45	EXK225	150	H80C	H125C	EXK125-C	125	H80C	H100C
P1-01160-H(P1-450H)	55	EXK225	200	H100C	H125C	EXK225	150	H100C	H125C
P1-01470-H(P1-550H)	75	EX400	250	H150C	H200C	EXK225	200	H150C	H200C
P1-01760-H(P1-750H)	90	EX400	300	H200C	H250C	EXK225	225	H200C	H200C
P1-02130-H(P1-900H)	110	EX400	400	H200C	H300C	EX400	300	H200C	H250C
P1-02520-H(P1-1100H)	132	EX600B	500	H250C	H300C	EX400	350	H250C	H300C
P1-03160-H(P1-1320H)	160	EX600B	600	H400C	H400C	EX400	400	H400C	H400C
P1-03720-H(P1-1600H)	185					RX600B	500	H400C	H600C
P1-04320-H(P1-1850H)	200					RX600B	500	H600C	H600C
P1-04860-H(P1-2000H)	220					RX600B	500	H600C	H600C
P1-05200-H(P1-2200H)	250					RX600B	600	H600C	H600C
P1-05500-H(P1-2500H)	280					RX600B	600	H600C	H600C
P1-06600-H(P1-3150H)	355					RX800B	700	H800C	H800C

◇ If export to the U.S. or Canada or compliance with UL/cUL standards is required, wires and breakers described in UL / cUL should be used. For details, see "1.5 Compliance to UL standards".

◇ Device model name on above table shows example selection. The device selection should be made in base on rated current, short circuit current capability and accordance to the local electrical legislation.

◇ Applicable motor capacity is based on Hitachi 400 VAC, 60Hz, 4 pole IE3 motor.

◇ Refer to the wire size table in chapter 2.6.

◇ Electrical endurance for AC-1 magnetic contactor is 500000 times, however, for emergency stop in motor operation will be only 25 times.

◇ Select AC-3 class magnetic contactor for inverter output for application which has an emergency stop or commercial power line operation.

◇ When selecting oversize inverter capacity compare to motor rating, select according to the inverter capacity.

◇ The inverter of 160kW (P1-1600H) or more, be sure to use a reactor for power factor correction. (Input side AC reactor or DC link choke, usually DC link choke)

### 2.8 Chopper Braking Resistor

- SJ Series P1 has a built-in chopper braking circuit in model below.  
P1-00044-L (004L) to P1-01240-L (022L)  
P1-00041-H (007H) to P1-00930-H (370H)
- By using an optional braking resistor, permit to use for high regeneration load application such as lift or high speed load.

- SJ Series P1 can offer when desired a built-in chopper braking circuit in models below.  
P1-01160-H (450H) to P1-01470-H (550H)
- Using optional braking unit or regenerative unit, permit to use on high regenerative load application even for models without built-in chopper braking circuit.
- The table below shows an example selection of braking resistor to output 100% of braking torque for each motor rating on list.

■200V class

Model P1-***** (P1-*****)	Applicable motor (kW)	Min. Resistor (Ω)	Resistor selection Ex. (Ω)	Braking Resistor			
				Model	Usage ratio (%)	Short period capacity (kW)	Rated capacity (kW)
00044-L (004L)	0.4	50	180	SRB200-1	10	0.7	0.2
00080-L (007L)	0.75	50	100	SRB200-1	10	0.7	0.2
00104-L (015L)	1.5	35	100	SRB200-2	7.5	1.25	0.2
00156-L (022L)	2.2	35	50	SRB300-1	7.5	2.5	0.3
00228-L (037L)	3.7	35	35	SRB400-1	7.5	3.6	0.4
00330-L (055L)	5.5	16	17	RB3	10	7.7	1.2
00460-L (075L)	7.5	10	17	RB3	10	7.7	1.2
00600-L (110L)	11	10	11.7	RB2 ×3 parallel	10	11.4	1.8
00800-L (150L)	15	7.5	8.5	RB3 ×2 parallel	10	15.4	2.4
00930-L (185L)	18.5	7.5	8.5	RB3 ×2 parallel	10	15.4	2.4
01240-L (220L)	22	5	5.7	RB3 ×3 parallel	10	23.1	3.6

◇ When using regenerative resistor SRB series and RB series in 400V class, be sure to use two in series because of the restriction of withstanding voltage of the resistor.

Example: In the case of RB2 × 2 series × 2 parallel, a total of 4 RB2s are required.

■400V

Model P1-***** (P1-*****)	Applicable motor (kW)	Min. Resistor (Ω)	Resistor selection Ex. (Ω)	Braking Resistor			
				Model	Usage ratio (%)	Short period capacity (kW)	Rated capacity (kW)
00041-H (007H)	0.75	100	360	SRB200-1 ×2series	10	1.4	0.4
00054-H (015H)	1.5	100	100	SRB200-1 ×2series	10	1.4	0.4
00083-H (022H)	2.2	100	100	SRB200-2 ×2series	7.5	2.5	0.4
00126-H (037H)	3.7	70	100	SRB300-1 ×2 series	7.5	5	0.6
00175-H (055H)	5.5	70	100	SRB300-1 ×2 series	7.5	5	0.6
00250-H (075H)	7.5	35	70	SRB400-1 ×2 series	7.5	7.2	0.8
00310-H (110H)	11	35	50	RB1 ×2 series ×2 parallel	10	10.4	1.6
00400-H (150H)	15	24	35	RB2 ×2 series ×2parallel	10	15.2	2.4
00470-H (185H)	18.5	24	35	RB2 ×2 series ×2parallel	10	15.2	2.4
00620-H (220H)	22	20	25	RB1 ×2 series ×4parallel	10	20.8	3.2
00770-H (300H)	30	15	17	RB3 ×2 series ×2parallel	10	30.8	4.8
00930-H (370H)	37	15	17	RB3 ×2 series ×2parallel	10	30.8	4.8
01160-H (450H)	45	10	10	CA-KB (10Ω5unit)	20	45	17
01470-H (550H)	55	10	10	CA-KB (10Ω5unit)	20	45	17

2.9 Wiring to the main circuit terminal block



When J51 connector is removed, charge lamp doesn't indicate R0-T0 status. Make sure that power is off and care for safety. For own safety, make sure to power off before handling the inverter. The charge lamp doesn't light up even with 24V power supply only.

<b>Model P1- ******(P1-*****)</b>
200V class: 00044-L(004L), 00080-L(007L), 00104-L(015L), 00156-L(022L), 00228-L(037L)
400V class: 00041-H(007H), 00054-H(015H), 00083-H(022H), 00126-H(037H)

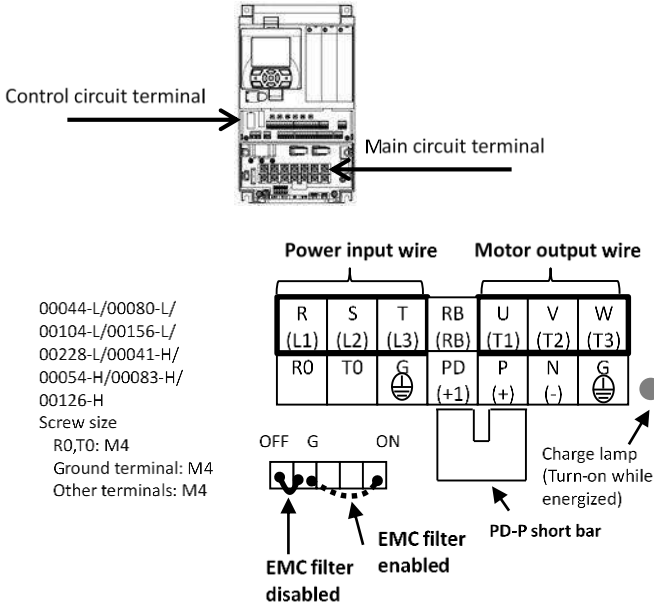

As shown in the figure above, the EMC filter switches enable / disable by replacing the shorting cable connected to the connector.

<b>Model P1 - ******(P1-*****)</b>
200V class: 00330-L(055L), 00460-L(075L), 00600-L(110L)
400V class: 00175-H(055H), 00250-H(075H), 00310-H(110H)

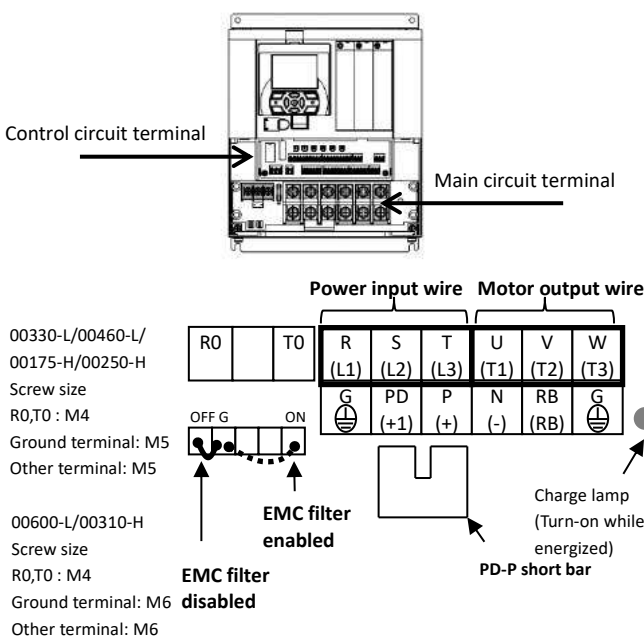

As shown in the figure above, the EMC filter switches enable / disable by replacing the shorting cable connected to the connector.

<b>Model P1- ******(P1-*****)</b>
200V class: 00800-L(150L)/00930-L(185L)/01240-L(220L)

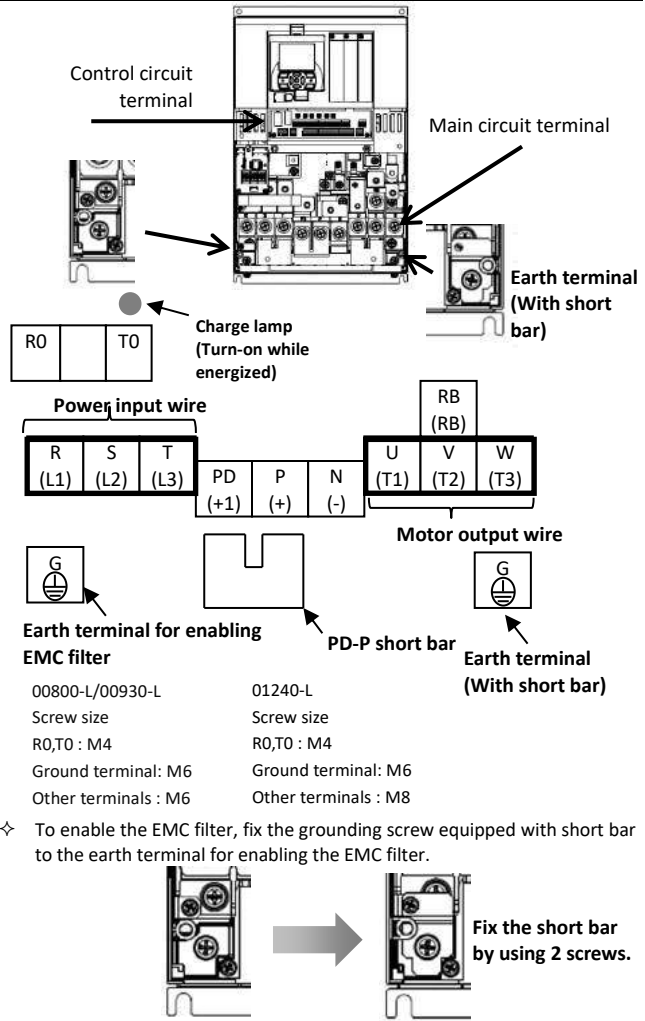

To enable the EMC filter, fix the grounding screw equipped with short bar to the earth terminal for enabling the EMC filter.

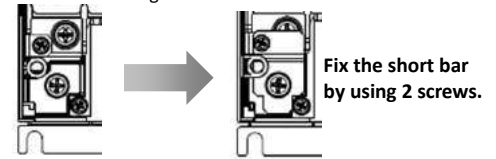

<b>Model P1- ******(P1-*****)</b>
400V class: 00400-H(150H), 00470-H(185H), 00620-H(220H)

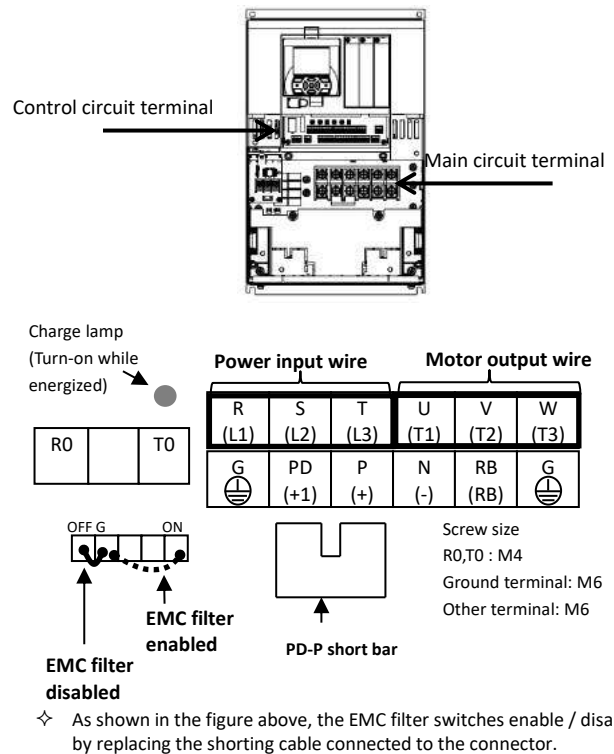

As shown in the figure above, the EMC filter switches enable / disable by replacing the shorting cable connected to the connector.

**Model P1- \*\*\*\*\*\*(P1-\*\*\*\*\*)**  
 200V class: 01530-L(300L)

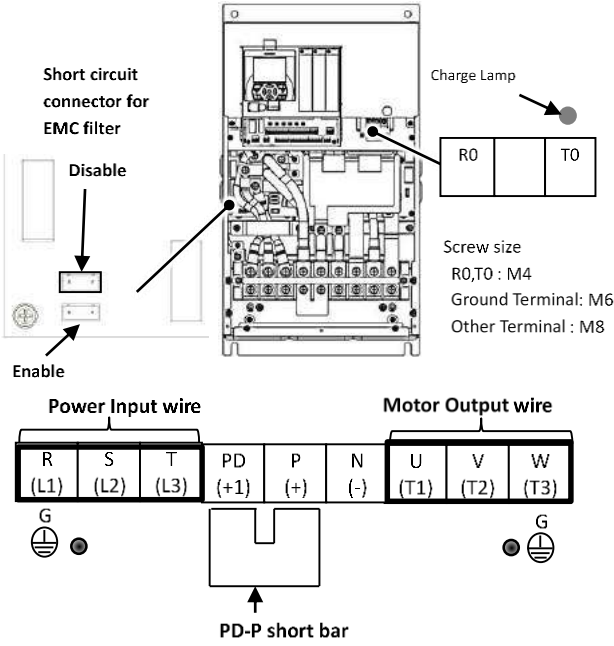

◇ Switch the short circuit connector to enable/disable the EMC filter.

**Model P1- \*\*\*\*\*\*(P1-\*\*\*\*\*)**  
 200V class: 01850-L(370L), 02290-L(450L)

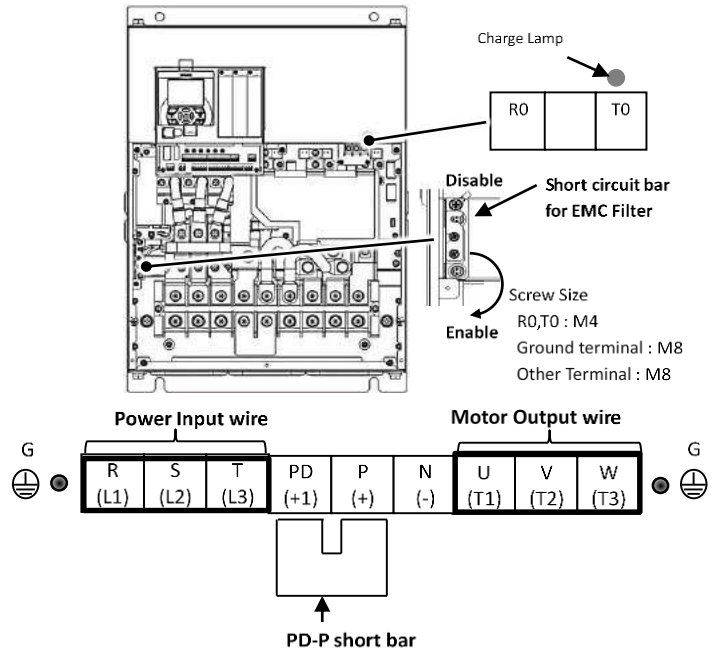

◇ Switch the short circuit bar to enable or disable the EMC filter as shown below.

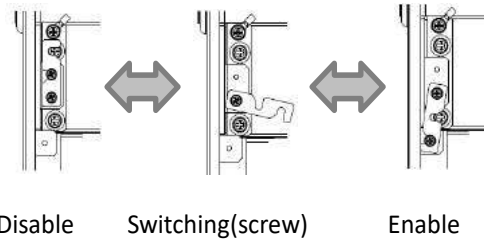

**Model P1- \*\*\*\*\*\*(P1-\*\*\*\*\*)**  
 400V class: 00770-H(300H)

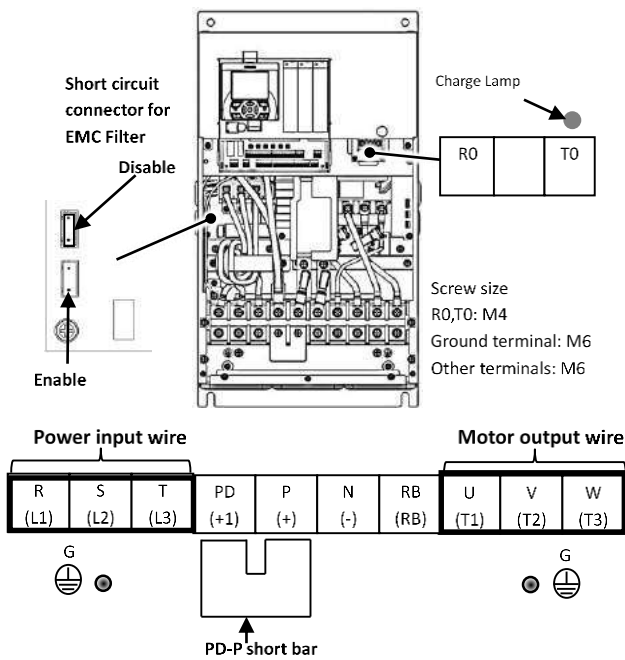

◇ Switch the short circuit connector to enable/disable the EMC filter.

**Model P1- \*\*\*\*\*\*(P1-\*\*\*\*\*)**  
 400V class: 00930-H(370H)

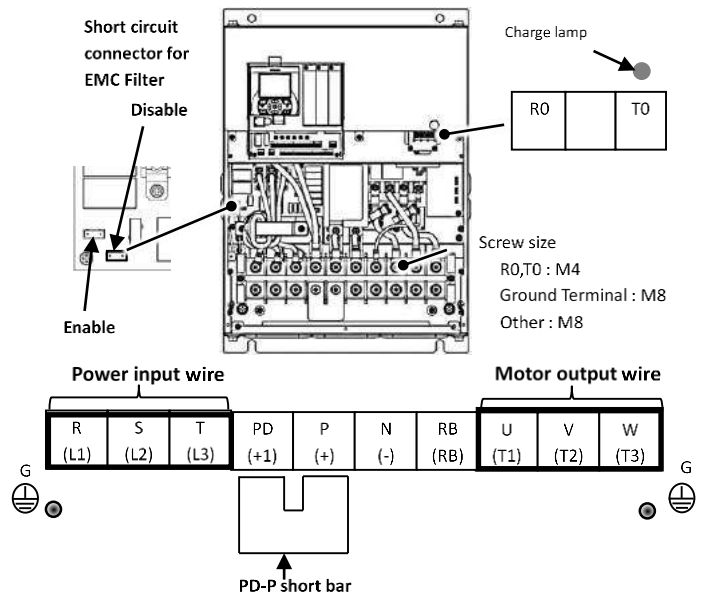

◇ Switch the short circuit connector to enable/disable the EMC filter.

**Model P1- \*\*\*\*\*\*(P1-\*\*\*\*)**  
 400V class: O1160-H(450H), O1470-H(550H)

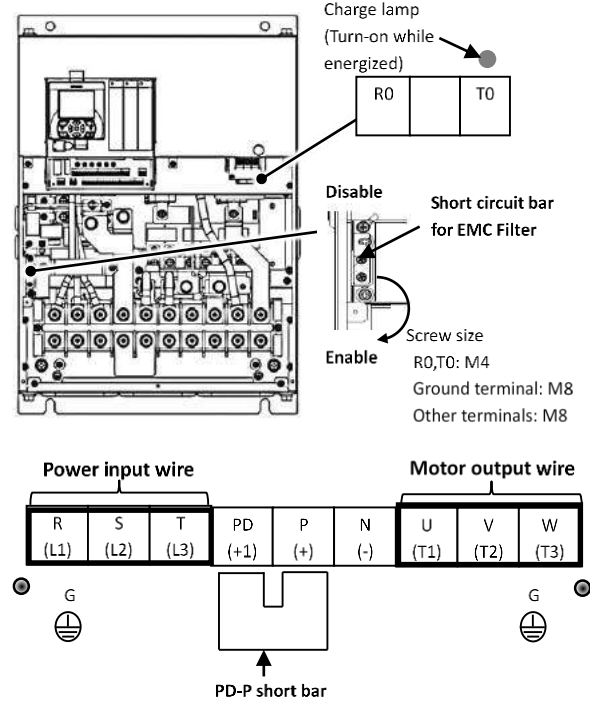

**Model P1- \*\*\*\*\*\*(P1-\*\*\*\*)**  
 200V class: O2950-L(550L)

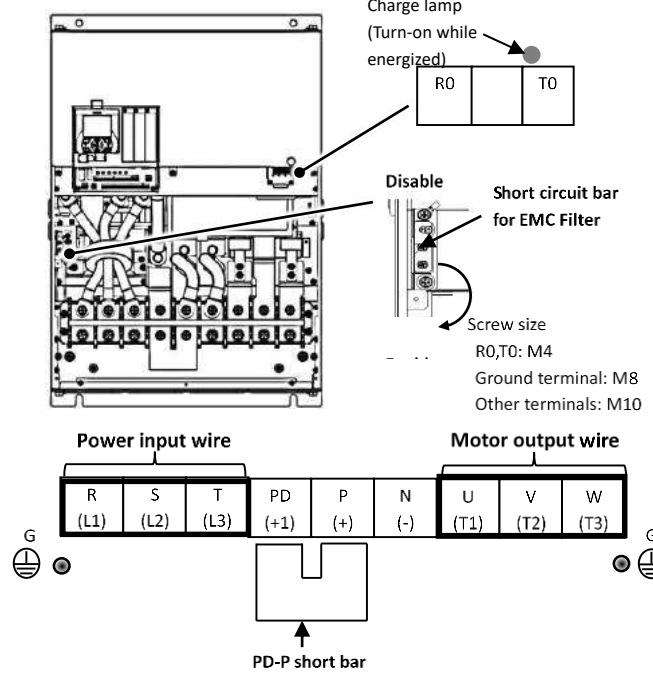

◇ For the switching method of EMC filter, see the lower section of this page.

◇ For the switching method of EMC filter, see the lower left section of this page.

◇ Switching method of EMC filter  
 Switch the short circuit bar to enable/disable the EMC filter.

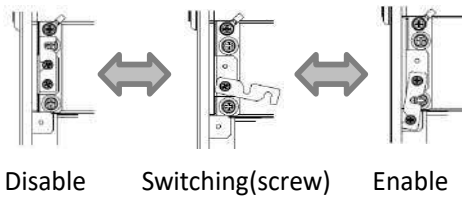

**Model P1- \*\*\*\*\*\*(P1-\*\*\*\*\*)**  
 400V class: 01760-H(750H), 01470-H(900H)

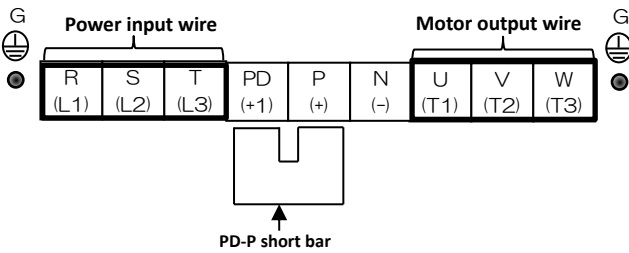
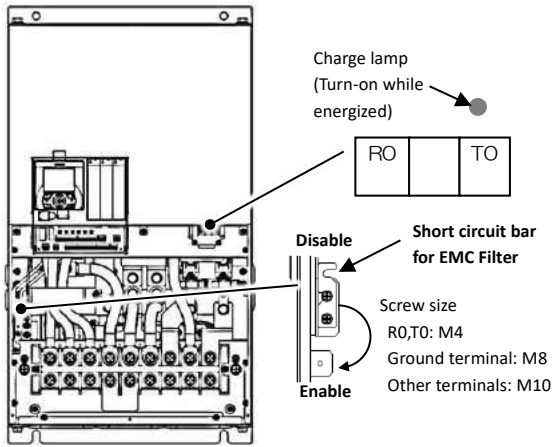

◇ For the switching method of EMC filter, see the lower section of this page.

**Model P1- \*\*\*\*\*\*(P1-\*\*\*\*\*)**  
 400V class: 02520-H(1100H), 03160-H(1320H)

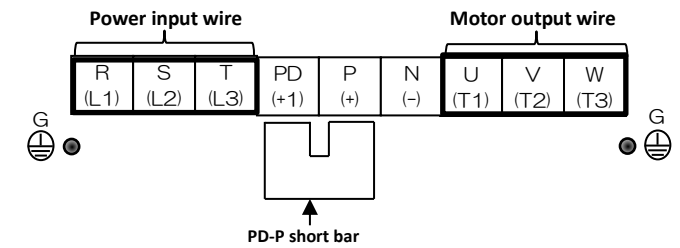
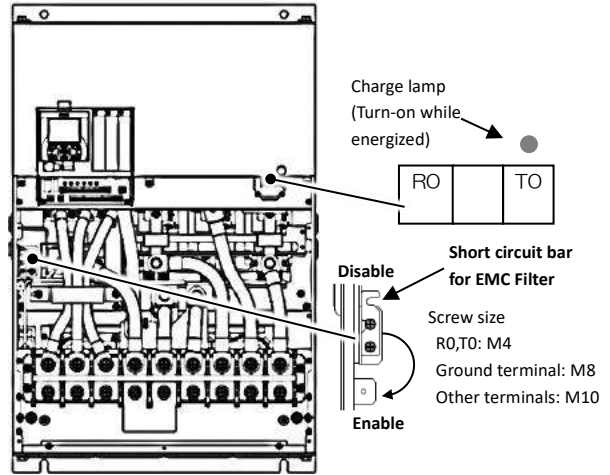

◇ For the switching method of EMC filter, see the lower left section of this page.

◇ Switching method of EMC filter  
 Switch the short circuit bar to enable/disable the EMC filter.

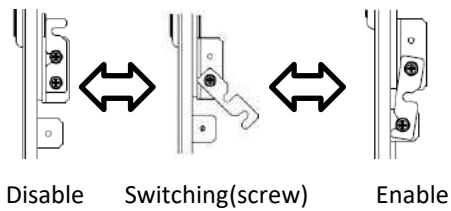

**Model P1- \*\*\*\*\*\*(P1-\*\*\*\*\*)**  
 400V class: 03720-H(1600H)

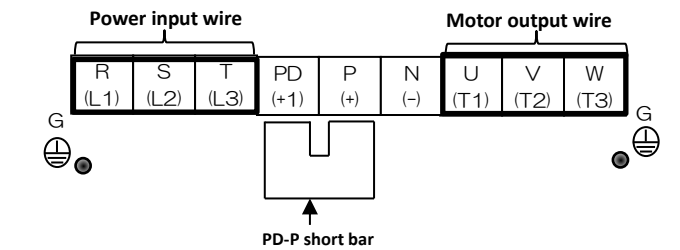
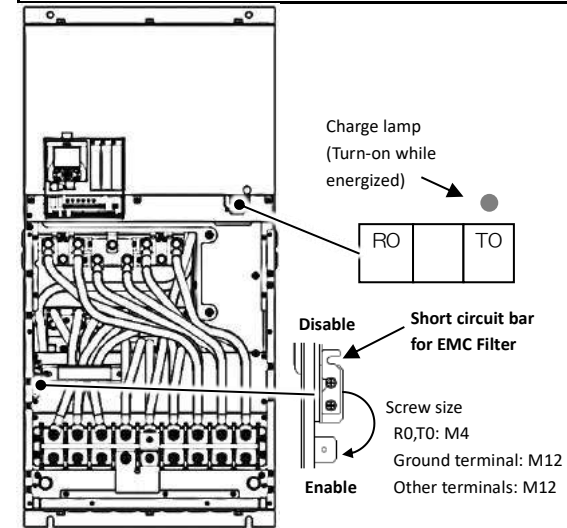

◇ For the switching method of EMC filter, see the left section of this page.

**Model P1- \*\*\*\*\*\*(P1-\*\*\*\*\*)**  
 400V class: 04320-H(1850H)

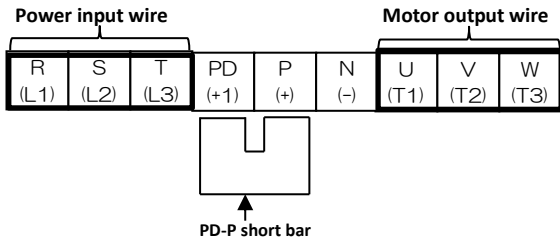
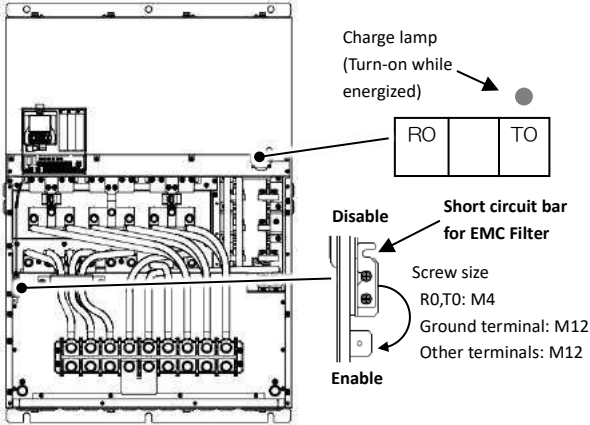

◇ For the switching method of EMC filter, see the below of this page.

**Model P1- \*\*\*\*\*\*(P1-\*\*\*\*\*)**  
 400V class: 04860-H(2000H), 05200-H(2200H), 05500-H(2500H)

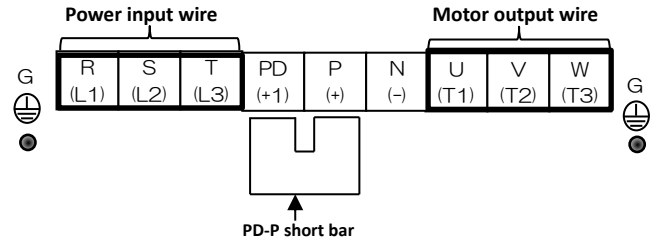
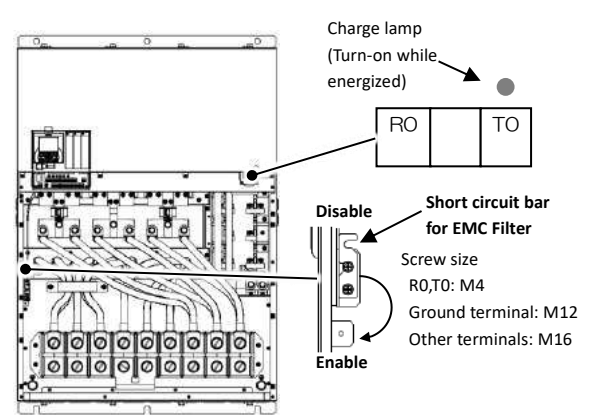

◇ For the switching method of EMC filter, see the left side of this page.

◇ Switching method of EMC filter  
 Switch the short circuit bar to enable/disable the EMC filter.  
 ■ P1-04320-H(P1-1850H) to P1-05500-H(P1-2500H)

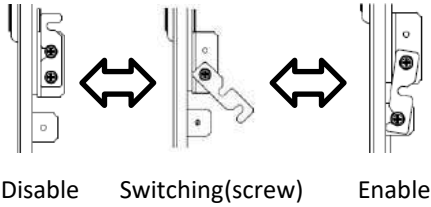

■ P1-06600-H(P1-3150H)

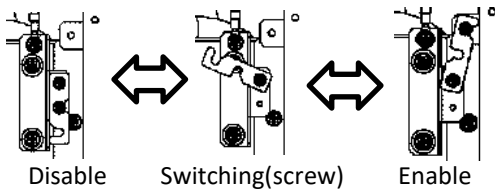

**Model P1- \*\*\*\*\*\*(P1-\*\*\*\*\*)**  
 400V class: 06600-H(3150H)

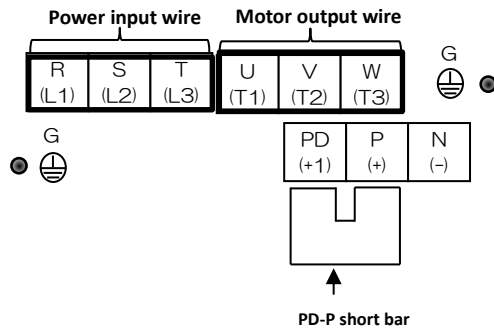
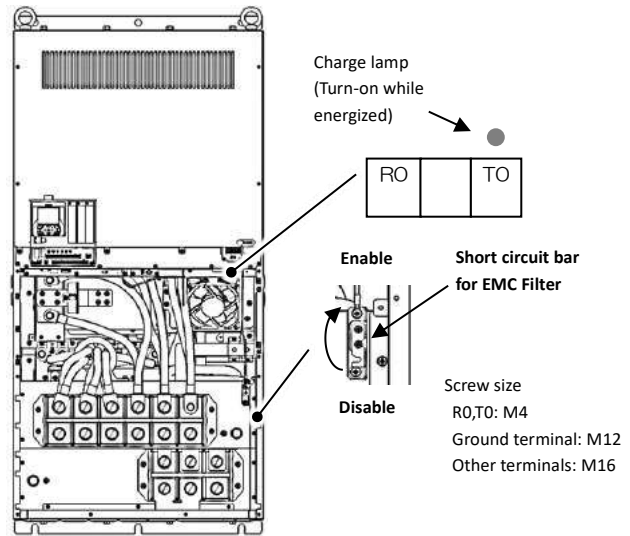

◇ For the switching method of EMC filter, see the left side of this page.

◇ For models without description, please contact your supplier or local Hitachi inverter sales office.

2.10 Wiring of the control circuit

◇ An example for sink logic.

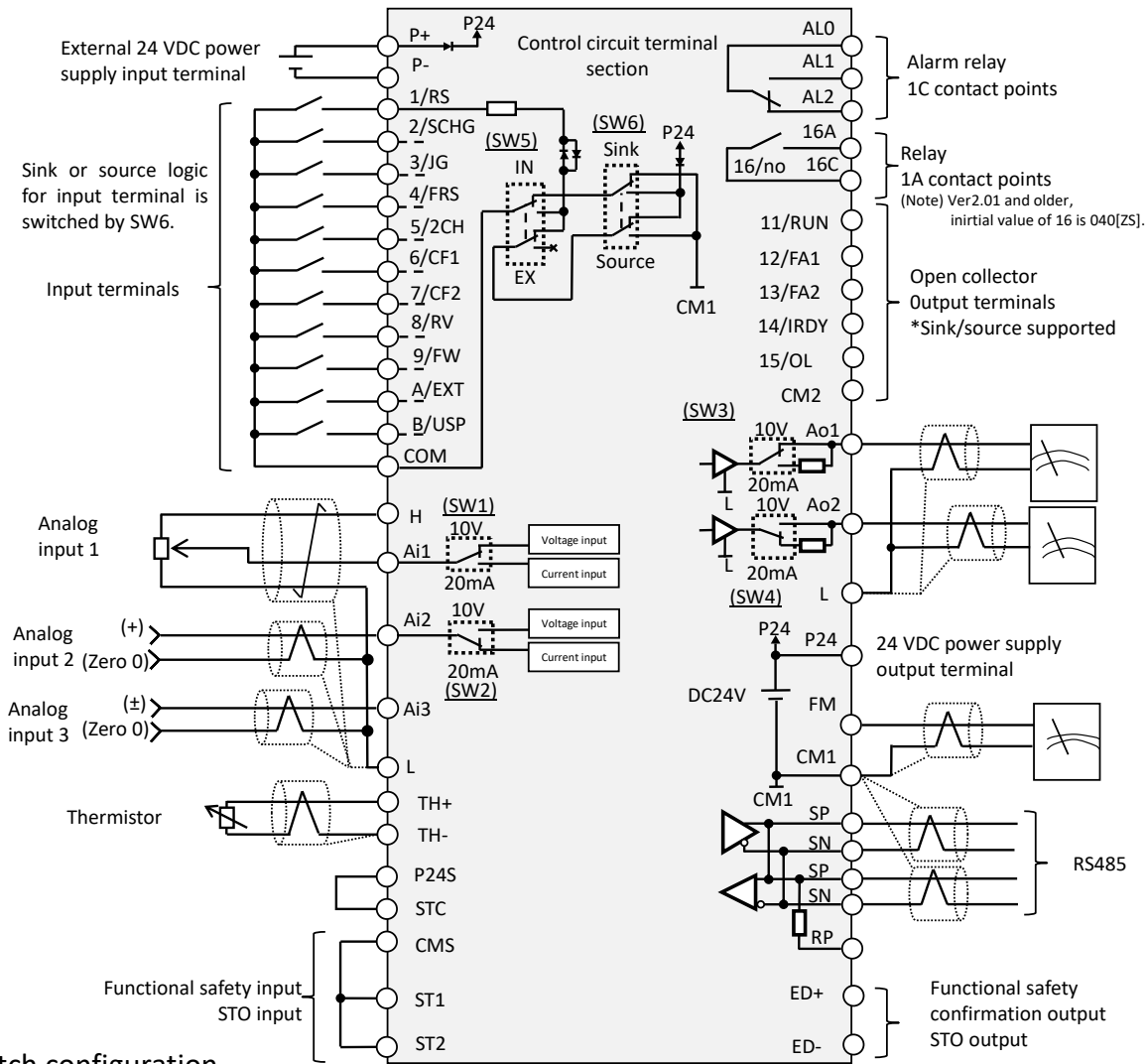

Switch configuration

Label	Switch Name	Description
Ai1 (SW1)	Analog input 1 switch	It changes the input specification of Analog input 1 (Ai1 terminal). 10V: Voltage input is available. 20mA: Current input is available.
Ai2 (SW2)	Analog input 2 switch	It changes the input specification of Analog input 2 (Ai2 terminal). 10V: Voltage input is available. 20mA: Current input is available.
Ao1 (SW3)	Analog output 1 switch	It changes the output specification of Analog output 1 (Ao1 terminal). 10V: Voltage output is applied. 20mA: Current output is applied.
Ao2 (SW4)	Analog output 2 switch	It changes the output specification of Analog output 2 (Ao2 terminal). 10V: Voltage output is applied. 20mA: Current output is applied.
P.SEL (SW5)	Power supply input switch	It changes the power supply source for input terminals. IN: Internal power supply. EX: External power supply. (While setting EX, it requires an external power supply between input terminals and COM terminal)
SRC/SINK (SW6)	Input terminal Sink/Source logic switching	It changes the sink or source logic for input terminal. It is enabled when SW5 is in IN position. SINK: Switch to Sink logic. SRC: Switch to Source logic.

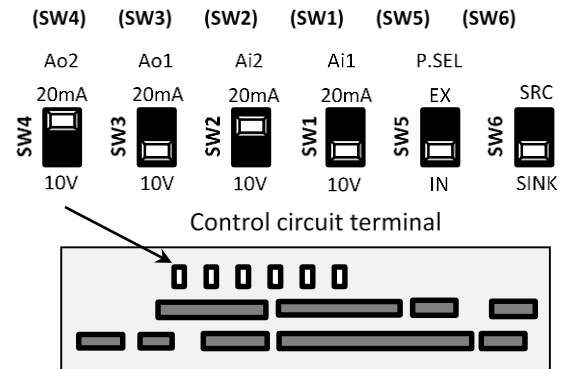

◇ Be sure to power-off previous to change any switches. Otherwise, the inverter may be damaged.



■ Recommended terminals for wiring

- The following ferrule terminals are recommended for signal cable for easy wiring and improving reliability of connectivity.

Ferrule terminal with sleeves

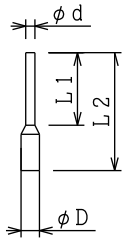
Wire size mm <sup>2</sup> (AWG)	Ferrule terminal model*	L1 [mm]	L2 [mm]	φd [mm]	φD [mm]	
0.25 (24)	AI 0,25-8YE	8	12.5	0.8	2.0	
0.34 (22)	AI 0,34-8TQ	8	12.5	0.8	2.0	
0.5 (20)	AI 0,5-8WH	8	14	1.1	2.5	
0.75 (18)	AI 0,75-8GY	8	14	1.3	2.8	

\*) Manufacturer: Phoenix Contact

Crimping tool: CRIMPFOX 6

■ Wiring procedure

1. Push the gray part(\*1) shown below on the control circuit terminal block into the socket with a slotted screwdriver (with a wide of 2.5mm or less). (Insertion hole will open)
  2. Plug in the wire or ferrule terminal to the wire insertion hole (round) while pressing the gray part(\*1) with a slotted screwdriver.
  3. The wire is connected to the circuit when release the screw driver.
- Even for pulling out the wire from the socket, press the gray part(\*1) with a slotted screwdriver (the insertion hole will be opened while pressing).

(\*1) The actual color of the gray part shown below is orange.

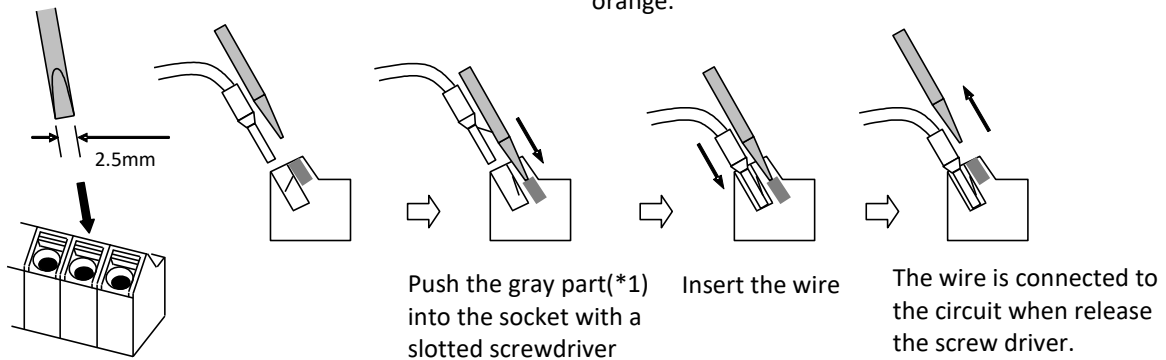

2.11 Control circuit wiring section

■ Input terminals

- All COMs have the same electric potential.
- Change SW5 to external power supply (EX) to connect the power supply between Input terminals 1 to 9, A or B, and COM.
- Sink or Source logic of the input terminals are switched by SW6.

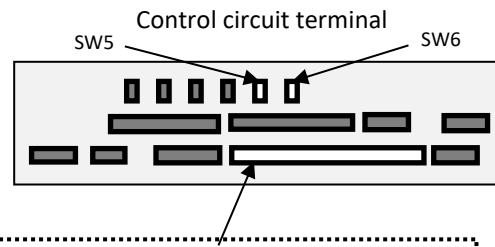

(Wiring example)

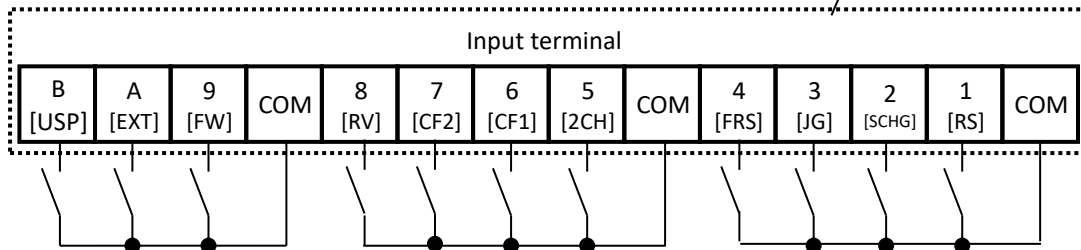

- [ ] means factory default settings.

		Terminal label	Terminal name	Description	Electric characteristics
Intelligent input terminals	Digital input	9, 8, 7, 6, 5, 4, 3, 2, 1	Input terminals	Each terminal can select input terminal functions by parameter setting. Switch the SINK / SRC of SW6 to select the sink logic and source logic.	<ul style="list-style-type: none"> <li>• Max. allowable voltage 27 VDC</li> <li>• Load current 5.6 mA (at 27 VDC)</li> </ul> Voltage between each input and the COM terminal: When using an external power supply: <ul style="list-style-type: none"> <li>• ON voltage Min.18 VDC</li> <li>• OFF voltage Max.3 VDC</li> </ul> When using the internal power supply: <ul style="list-style-type: none"> <li>• ON voltage Max.3 VDC</li> <li>• OFF voltage Min.18 VDC</li> </ul> <ul style="list-style-type: none"> <li>• Maximum 32 kpps pulse input (When terminal A and B function is pulse train input A/B)</li> </ul>
		A	Pulse input-A	When [CA-90] is set to 00, A and B terminals can be used as input terminals. Each terminal can select input terminal functions by parameter setting. When [CA-90] is not set to 00, they are used as terminals for pulse train input. The maximum input pulse is 32kpps	
	B	Pulse input-B	When [CA-90] is not set to 00, they are used as terminals for pulse train input. The maximum input pulse is 32kpps		
	Common	COM	Input (common)	This is a common terminal for digital input terminals (1,2,3,4,5,6,7,8,9,A and B). Three COM terminals are available.	

■ Terminal's default function ([symbol: setting No.]

[RS:028] Reset

- Reset at every trip.

[SCHG:015] Main/Sub speed reference change

- Change to the main speed command [AA101](OFF) or sub-speed command [AA102](ON).

[JG:029] Jogging

- [JG]ON runs the inverter at a frequency of [AG-20].

[FRS:032] Free run stop

- [FRS]ON sets the motor in a free-run state.

[2CH:031] 2-stage acceleration/deceleration

- [2CH]ON enables acceleration/deceleration time-2 [AC124][AC126].

[EXT:033] External fault

- [EXT]ON issues Trip[E012].

[FW:001] Forward rotation and [RV:002] Reverse rotation

Forward	Reverse	Description
OFF	OFF	No command
ON	OFF	Forward rotation RUN command.
OFF	ON	Reverse rotation RUN command.
ON	ON	No command (inconsistent logic)

[CF1:003] Multispeed-1 and [CF2:004] Multispeed-2 commands

Multispeed-1 CF1	Multispeed-2 CF2	Description
OFF	OFF	The set frequency source is enabled.
ON	OFF	The frequency source of [Ab-11] is enabled.
OFF	ON	The frequency source of [Ab-12] is enabled.
ON	ON	The frequency source of [Ab-13] is enabled.

\*) Setting CF3 and 4 allows you to set up to 16-speed.

[USP:034] unattended start protection

- In a [USP]ON state, if a RUN command has been input before the power supply is ON, Trip[E013] is issued.

■ Output terminals  
(Wiring example)

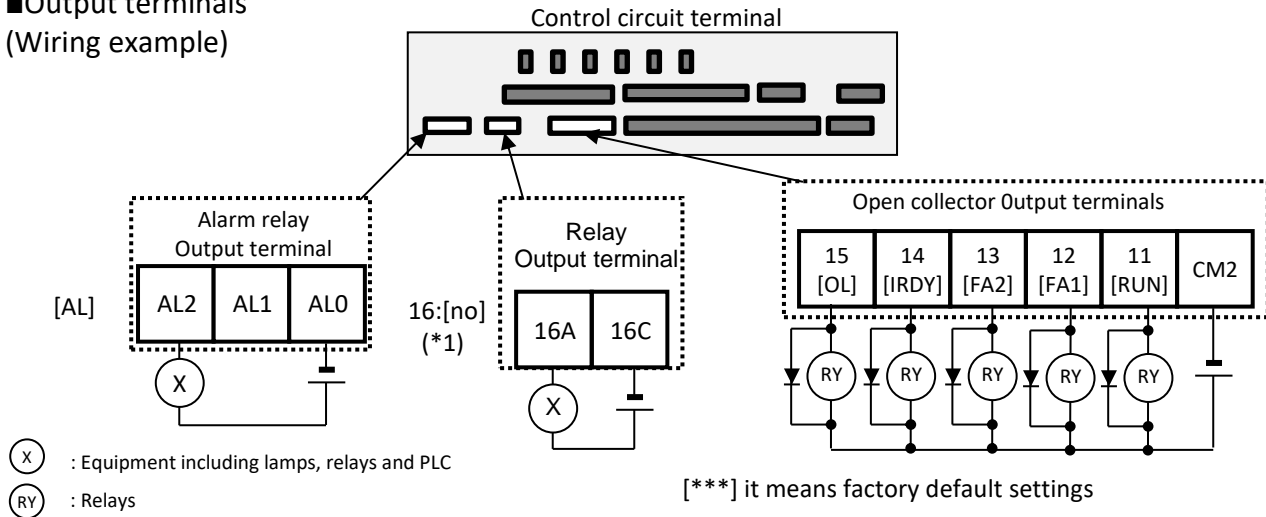

			Terminal label	Terminal name	Description	Electric characteristics
Intelligent output terminals	Digital output	Open collector	15 14 13 12 11	Output terminals	Terminal functions are selectable according to the parameter settings for each terminal. These are available for both Sink and Source logics.	Open collector output Between each terminal and CM2 • Voltage drop when turned on: 4 VDC or less • Max. allowable voltage 27 VDC • Max. allowable current 50 mA
			CM2	Output (common)	This is a common terminal for output terminals 11 to 15.	
	Relay	Relay	16A 16C	1a relay terminals	A relay for A contact outputs	Maximum contact capacity 250 VAC, 2 A(resistance) / 250 VAC, 1 A(inductive load) 30 VDC, 3 A(resistance) / 30 VDC, 0.6 A(inductive load) Minimum contact capacity 5 VDC, 10 mA
			AL0 AL1 AL2	1c relay terminals	A relay for C contact outputs	Maximum contact capacity AL1/AL0: 250 VAC, 2 A(resistance) / 250 VAC, 0.2 A(inductive load) 30 VDC, 3 A(resistance) / 30 VDC, 0.6 A(inductive load) AL2/AL0: 250 VAC, 1 A(resistance) / 250 VAC, 0.2 A(inductive load) 30 VDC, 1 A(resistance) / 30 VDC, 0.2 A(inductive load) Minimum contact capacity (common) 100 VAC, 10 mA / 5 VDC, 100 mA

■ Terminal's default function

[RUN:001] Running

- Turns ON during operation (PWM output).

[FA1:002] Constant-frequency reached

- Turns ON when the output frequency reaches the control frequency.

[FA2:003] Set frequency overreached

- Turns ON when the output frequency reaches the control frequency [CE-10] / [CE-11].

[IRDY:007] inverter ready

- Turns ON when is ready for operation.

[OL:035] Overload notice advance signal

- Turns ON when the current exceeds the overload warning level.

[AL:017] Operation

- In case of [CC-17]=00 (factory setting)

Power supply	Status	AL0-AL1	AL0-AL2
ON	Normal operation	Open	Closed
ON	Tripping	Closed	Open
OFF	–	Open	Closed

- In case of [CC-17]=01

Power supply	Status	AL0-AL1	AL0-AL2
ON	Normal operation	Closed	Open
ON	Tripping	Open	Closed
OFF	–	Open	Closed

(\*1):Ver2.01 or older, the initial value of relay output 16 is 040[ZS].

[ZS:040] Zero speed detection

- Turns ON when the output frequency goes below the Zero speed detection level [CE-33].

■ Analog input/output  
(Wiring example)

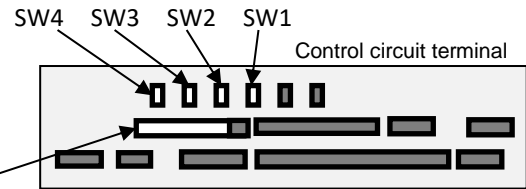
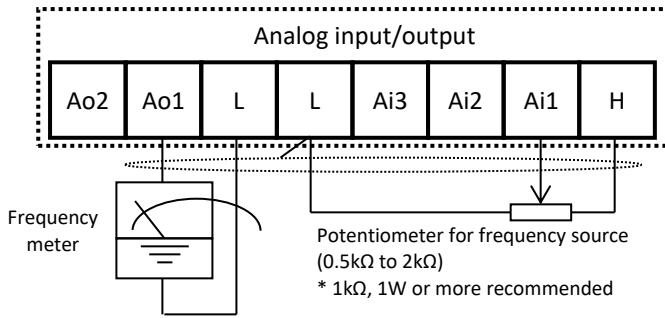

- When variable resistor is connected on H-Ai1-L terminal, voltage input is given to inverter, Sw1 for analog input 1 (Ai1) is to be set on "voltage" side therefore.
- If a frequency meter connected in left example is current type (4 to 20mA), set SW3 for analog output 1 (Ao1) as current output. (NOTE) Refer to section 3.9 to 3.11 for adjustment example.

		Terminal label	Terminal name	Description	Electric characteristics
Voltage/current switchable analog input/output terminal	Power supply	L	Common for analog power supply	Common terminals for analog input terminals (Ai1,Ai2,Ai3) and analog output terminals (Ao1,Ao2). Two L terminals are available.	
		H	Speed setting power supply	10 VDC power supply. Used for voltage input with analog input terminals (Ai1,Ai2,Ai3) using a variable resistor.	Allowable load current is 20 mA or less
	Analog input	Ai1	Analog input terminal 1 (Voltage/current selector SW1)	Either Ai1 or Ai2 can be used by switching the selector switch to DC0 to 10V input or DC0 to 20 mA input. Used as speed input and feedback input.	For voltage input: <ul style="list-style-type: none"> <li>• Input impedance Approx.10 kΩ</li> <li>• Allowable input voltage -0.3 VDC to 12 VDC</li> </ul> For current input: <ul style="list-style-type: none"> <li>• Input impedance Approx.100 Ω</li> <li>• Max. allowable input current 24 mA</li> </ul>
		Ai2	Analog input terminal 2 (Voltage/current selector SW2)		
		Ai3	Analog input terminal 3	DC-10 to 10V voltage input is available. Used as speed input and feedback input.	Voltage input only: <ul style="list-style-type: none"> <li>• Input impedance Approx.10 kΩ</li> <li>• Allowable voltage input -12 VDC to 12 VDC</li> </ul>
	Analog output	Ao1	Analog output terminal 1 (Voltage/current selector SW3)	Either Ao1 or Ao2 can be used as an output for inverter monitoring data by switching the selector switch to DC0 to 10V voltage output or DC0 to 20 mA current output.	For voltage output: <ul style="list-style-type: none"> <li>• Max. allowable output current 2 mA</li> <li>• Output voltage accuracy ±10% (Ambient temperature: 25±10 degrees C)</li> </ul> For current output : <ul style="list-style-type: none"> <li>• Allowable load impedance 250 Ω or less</li> <li>• Output current accuracy ±20% (Ambient temperature: 25±10 degrees C)</li> </ul>
Ao2		Analog output terminal 2 (Voltage/current selector SW4)			

■ External thermistor  
(Wiring example)

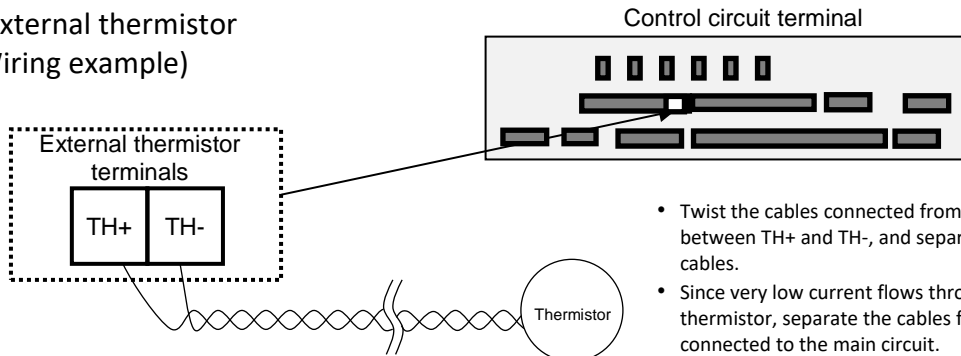

- Twist the cables connected from a thermistor to the TH terminal only between TH+ and TH-, and separate the twisted cables from other cables.
- Since very low current flows through the cables connected to the thermistor, separate the cables from those (power line cables) connected to the main circuit.
- The length of the cables connected to the thermistor must be 20m or less.

		Terminal label	Terminal name	Description	Electric characteristics
Thermistor terminal	Analog input	TH+	External thermistor input	Connect an external thermistor and trip the inverter if an abnormal temperature is detected. Connect the thermistor to TH+ and TH-. The impedance to detect temperature errors can be adjusted within the range 0Ω to 10,000Ω. [Recommended thermistor properties] Allowable rated power: 100 mW or more Impedance at temperature error: 3kΩ	DC0 to 5V [Input circuit]
		TH-	Common terminal for external thermistor input		

■ Functional safety terminals

◇ To use this function, refer to the P1 User's Guide and the separate "Safety function Guide"(NT2512\*X).

Terminal label	Terminal name
P24S	24V power supply terminal (STO dedicated terminal)
CMS	24V power supply common terminal (STO dedicated terminal)
STC	Logic switching terminal
ST1	STO input1
ST2	STO input2
ED+	EDM signal output terminal (+)
ED-	EDM signal output terminal (-)

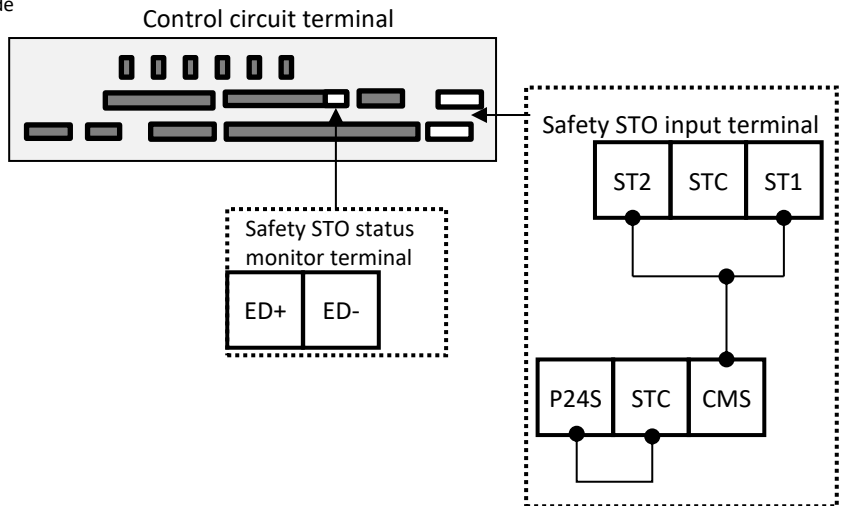

Note : Do not connect P24S, CMS, STC, ST1, ST2 to other control circuit terminals.

■ FM output terminals  
(Wiring example)

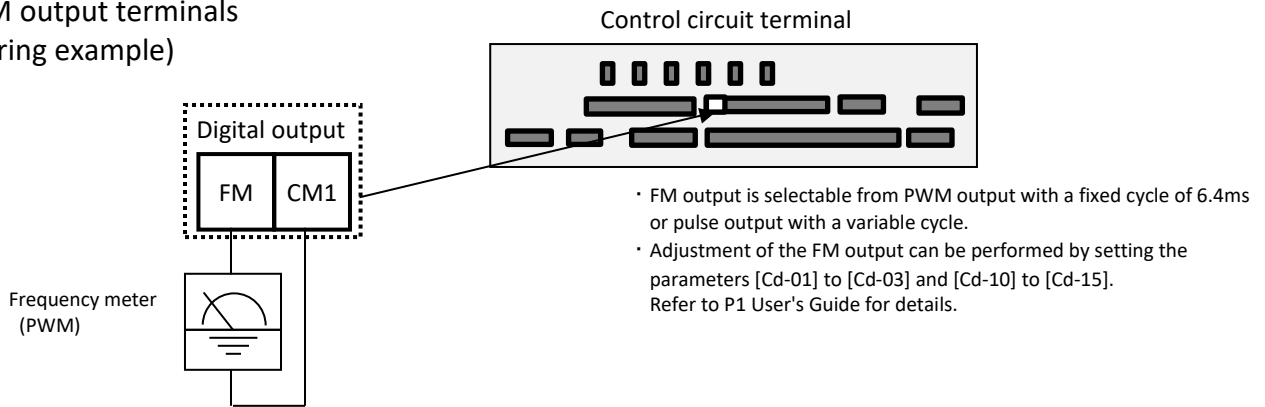

			Terminal label	Terminal name	Description	Electric characteristics
FM output terminal	FM output	Monitor output	FM	Digital monitor (voltage)	Digital monitor output is selectable from PWM output with 6.4ms cycle or pulse output with a variable duty cycle of approx. 50%.	Pulse train output 0 VDC to 10 VDC • Max. allowable output current 1.2 mA • Maximum frequency 3.60 kHz
			CM1	COM for digital monitor	This is a common terminal for digital monitor. This is also used as 0V reference potential for P24.	

■ Serial communication  
(Wiring example)

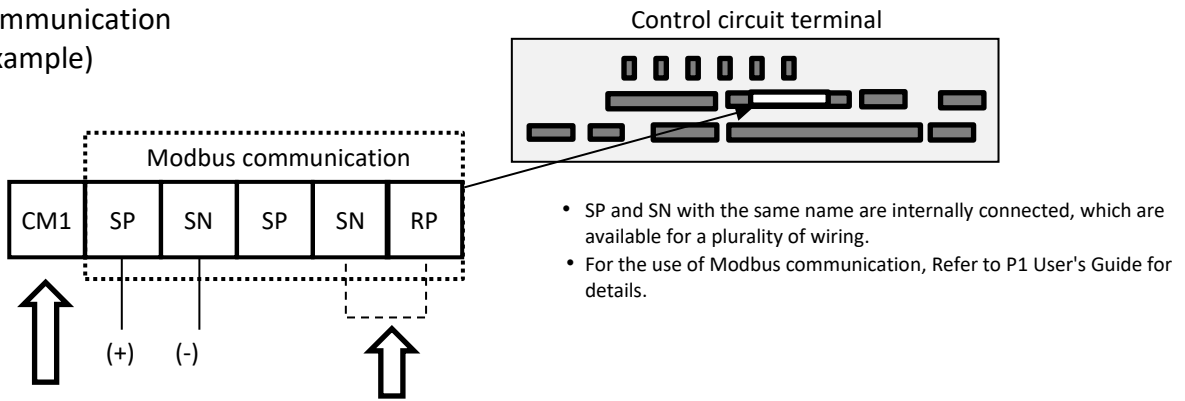

Connect CM1  
Into the SG (signal ground) of  
external devices,

For enabling the termination  
resistor, short-circuit between  
RP and SN.

	Terminal label	Terminal name	Description	Electric characteristics	
RS485 communication	Serial communication	SP SN RP (CM1)	MODBUS terminal (RS-485)	SP terminal: RS-485 differential(+) signal SN terminal: RS-485 differential(-) signal RP terminal: Connect to SP through a termination resistor CM1 terminal: Connect to the signal ground of external communication devices. There are two SP terminals and they are connected internally for daisy chain connection. The SN terminals connection is same as the SP terminals too. The maximum baud rate is 115.2kbps.	Termination resistor (120Ω) integrated Enabled: RP-SN shorted Disabled: RP-SN opened

■ 24 VDC power supply input/output  
(Wiring example)

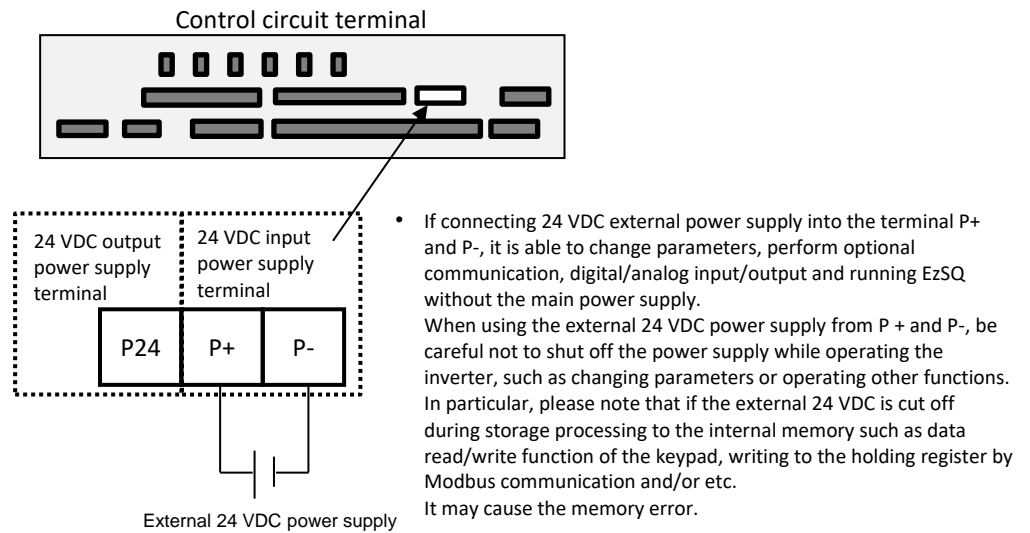

	Terminal label	Terminal name	Description	Electric characteristics	
24 VDC power supply	Input / Output	P24	24 VDC output power supply terminal	This terminal supplies 24 VDC power for contact signals.	Max. output 100 mA
		P+	External 24 VDC power supply input (24 VDC)	Input external 24 VDC power supply to the inverter. 24 VDC power supply input permits to change parameter settings and perform optional communication operations without control power supply.	Allowable input voltage 24 VDC±10% Max.current consumption 1 A
		P-	External 24 VDC power supply input (0 VDC)		

2.12 Residual risk

Parts subject to residual risk

Please check for residual risks before turning on the power supply upon completion of the installation.

Residual risk checklist No.

Target section	Name of part	DANGER	WARNING	CAUTION
(A)	Main circuit terminal block	8,10		
(B)	Heat sink	4		1
(C)	Control circuit terminal block	11		
(D)	Motor connected with the inverter and wiring to the motor	12,13		
-	Unspecified parts	9,14,15		2,3,5,6,7

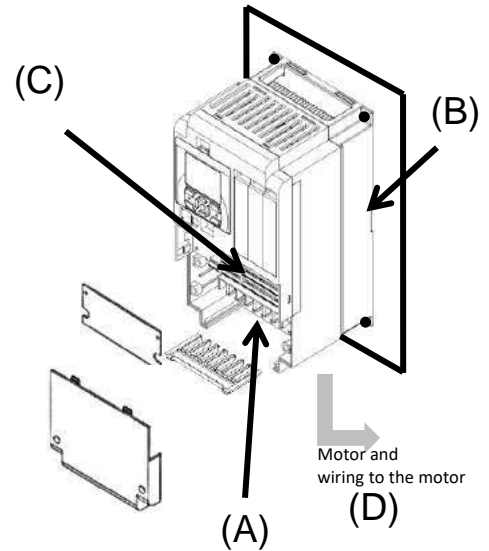

Residual risk checklist

No.	Operation stage	Work	Target section	Residual risk	Details of harm	Protective measure	√
1	Installation	Installation	(B)	Caution	Damage caused by careless transport	Do not drop the product. Do not carry the inverter in a manner that applies force to the cover or operator keypad.	<input type="checkbox"/>
2	Installation	Installation	-	Caution	Reduction of component life due to use in a location exposed to direct sunlight or at a temperature outside the specification range.	Check that ambient temperature is within the standard specification range in the whole year by means of cooling and ventilation.	<input type="checkbox"/>
3	Installation	Installation	-	Caution	Failure due to short circuit caused by using in a location which humidity and condensation are out of standard range described in specification.	Check that ambient temperature is within the standard specification range in the whole year by means of cooling and ventilation. Otherwise, install the product in a location free from condensation.	<input type="checkbox"/>
4	Installation	Installation	(B)	DANGER	The cooling fin that is heated to exceed 150°C catches fire to a flammable wall.	Install the inverter on an inflammable metal wall.	<input type="checkbox"/>
5	Installation	Installation	-	Caution	Component failure due to entry of dust, corrosive gas, or other substances.	Install the inverter inside a totally enclosed panel.	<input type="checkbox"/>
6	Installation	Installation	-	Caution	Reduction of a component life due to degradation of cooling capability by horizontal installation.	Install the inverter vertically.	<input type="checkbox"/>
7	Installation	Installation	-	Caution	When the fin of the inverter is installed outside of cabinet, the cooling fan fails due to droplet, oil mist, etc.	When installing the fin of inverter outside the cabinet, install it in a location free from droplet, oil mist, etc.	<input type="checkbox"/>
8	Maintenance for installation	Electrical connections	(A)	DANGER	The arc flies due to screws loosened by vibration, and catches fire to the internal components.	Check screws are appropriately tightened on a regular basis.	<input type="checkbox"/>
9	Maintenance for installation	Electrical connections	-	DANGER	The arc flies due to screws loosened by vibration, and catches fire to the internal components.	Check screws are appropriately tightened on a regular basis. Do not place flammable materials near the installed inverter.	<input type="checkbox"/>
10	Maintenance for use	Wiring Inspection	(A)	DANGER	When the cover is removed, electric shock is caused in a high-voltage section.	Do not remove the cover when power is supplied. After power is turned off, wait 10 minutes or more to perform working.	<input type="checkbox"/>
11	Maintenance for use	Wiring Inspection	(C)	DANGER	When the operator removes the cover, electric shock is caused when a tool touches a high-voltage section.	Do not remove the cover when power is supplied. After power is turned off, wait 10 minutes or more to perform working.	<input type="checkbox"/>

\* Installation, wiring, and setting work need to be performed by specialized technicians.

No.	Operation stage	Work	Target section	Residual risk	Details of harm	Protective measure	√
12 (a)	Installation	Electrical connections	(D)	DANGER	Due to long wiring length, the insulation of the motor degraded by surge, which eventually burns the motor.	If the wiring length exceeds 20m, shorten the motor wiring length. Or install the optional LCR filter and output side AC reactor.	<input type="checkbox"/>
12 (b)	Installation	Electrical connections	(D)	DANGER	By a motor is connected to the different voltage class inverter, insulation of the motor degraded, which eventually burns the motor.	Match the voltage class of inverter and that of motor.	<input type="checkbox"/>
12 (c)	Installation	Electrical connections	(D)	DANGER	Due to unstable output caused by imbalance of power supply voltage, undervoltage, extreme voltage drop, aging of motor, the motor burns, and eventually the inverter fails.	Check the receiving voltage of inverter, power receiving method, and power supply capacity are appropriate.	<input type="checkbox"/>
12 (d)	Maintenance for use	Wiring Inspection	(D)	DANGER	The short circuit failure caused by degradation of motor insulation, cracking of aged wires, etc., causes phase loss on inverter output, motor cable, and motor. Driving the inverter in such a condition burns the motor, and eventually the inverter fails.	Check there is no phase loss by inspection.	<input type="checkbox"/>
12 (e)	Installation Use	Setting	(D)	DANGER	By performing inappropriate parameter settings, high current flows in the motor, causing it to burn.	Set appropriate values for parameters related to motor electronic thermal function [bC110] to [bC225]. Set appropriate values for the settings of base frequency, rated motor voltage, motor constant, load type, DC braking and control mode. (representative parameters) Motor-related parameters: IM: [Hb102] to [Hb118] SM (PMM): [Hd102] to [Hd118] Control mode: [AA121] Load type selection: [Ub-03] DC braking: [AF101] to [AF109]	<input type="checkbox"/>
13	Use	Operation	(D)	DANGER	The stopped motor automatically starts running.	To restart the motor after stopping it by a function, define it in the system.	<input type="checkbox"/>
14	General	General	-	DANGER	Damage and injury caused by hidden risks.	Perform risk assessment on the system, and check that the fail safe function is incorporated into the system.	<input type="checkbox"/>
15	General	General	-	DANGER	Damage and injury caused by failure to obtain additional information concerning risks.	Obtain the latest version of User's Guide so that necessary information can be checked. Communicate information to the end users as necessary.	<input type="checkbox"/>

\* Installation, wiring, and setting work need to be performed by specialized technicians.

\* When using the input terminal 024[SET] function, also check the second settings.



# Chapter 3 Operation Setting and Examples of I/O Adjustment

This chapter describes **basic settings**, **example of frequency reference destination selection and setting**, **example of RUN command destination selection and setting** and **example of analog input/output adjustment**.

■ Basic settings 1

### 3.1 Set the load rating

- Select [Ub-03] load type selection on the parameter setting screen.

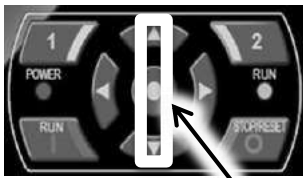
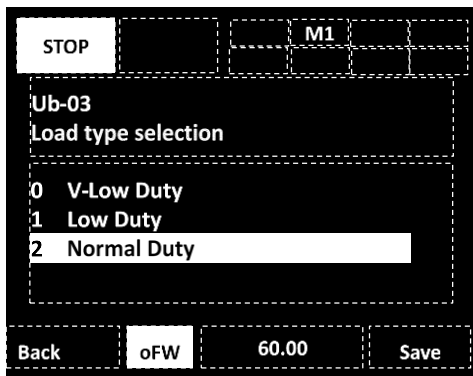

- When [Ub-03] is changed, the parameters set for the current are automatically adjusted in proportion to the changed rated current, and the set values are changed.
- Therefore, change the parameters value for setting the current value such as electronic thermal, overload limit, etc., so change [Ub-03] first.

■ Parameter

Parameter	Details	Setting data
[Ub-03]	Load type selection.	00: Very Low Duty (VLD) 01: Low Duty (LD) <u>02: Normal Duty (ND)</u>

\*) The underlined value is set by default.

Note: The rated load types of P1-05500-H (P1-2500H) and P1-06600-H (P1-3150H) are available for normal duty (ND) and low duty (LD). With these models, even if a Very Low Duty (VLD) is selected in [Ub-03], it is processed as a Low Duty (LD).

See "Chapter 4 Settings" for detailed operating instructions

■ Basic settings 2

### 3.2 Set the motor data

- Set the parameters listed in the table below on the parameter setting screen according to the motor you use (e.g. induction motor and permanent-magnet motor).

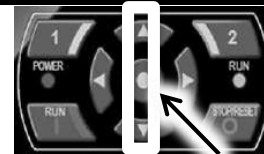
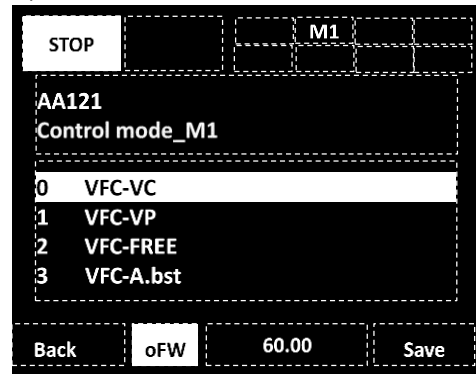

■ Parameter

- Induction motor (IM)

Parameter	Details	Setting data
[AA121]	Control mode selection, 1st-motor	00: [V/f] Fixed torque characteristics (IM) , etc.
[Hb102]	Async. Motor capacity setting, 1st-motor	0.01 to 160.00 (kW) (In the case of P1-1600H or more 0.01 to 500.00(kW) )
[Hb103]	Async. Motor number of poles setting, 1st-motor	2 to 48 (poles)
[Hb104]	Async. Motor base frequency setting ,1st-motor	10.00 to 590.00 (Hz)
[Hb105]	Async. Motor maximum frequency setting ,1st-motor	10.00 to 590.00 (Hz)
[Hb106]	Async. Motor rated voltage, 1st-motor	1 to 1000 (V)
[Hb108]	Async. Motor rated current, 1st-motor	0.01 to 10000.00 (A)

- Synchronous motor (permanent-magnet motor) (SM(PMM))

Parameter	Details	Setting data
[AA121]	Control mode selection, 1st-motor	11: Synchronous start type sensorless vector control(SM/PMM)) , etc
[Hd102]	Sync. Motor capacity setting, 1st-motor	0.01 to 160.00 (kW) (In the case of P1-1600H or more 0.01 to 500.00(kW) )
[Hd103]	Sync. Motor number of poles setting, 1st-motor	2 to 48 (poles)
[Hd104]	Sync. Base frequency setting, 1st-motor	10.00 to 590.00 (Hz)
[Hd105]	Sync. Maximum frequency setting, 1st-motor	10.00 to 590.00 (Hz)
[Hd106]	Sync. Motor rated voltage, 1st-motor	1 to 1000 (V)
[Hd108]	Sync. Motor rated current, 1st-motor	0.01 to 10000.00 (A)

Note: Motor constant setting is required for driving SM.

Driving inverter requires a frequency reference and an operation command. Set “Run command source” and “Frequency reference source” referring to this chapter. (Refer to the P1 User's Guide for more detailed settings.)

■ Frequency source 1

3.3 Frequency setting on the keypad

- Select [AA101] = 07: Parameter Setting.  
( Frequency reference is selected by parameter setting. ).
- Changing frequency setting from each source  
(1) [FA-01] “Main speed reference setting or monitor” or  
(2) [Ab110] “Multi-speed 0 setting, 1st-motor”

Eg.) For [FA-01]

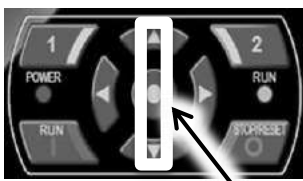
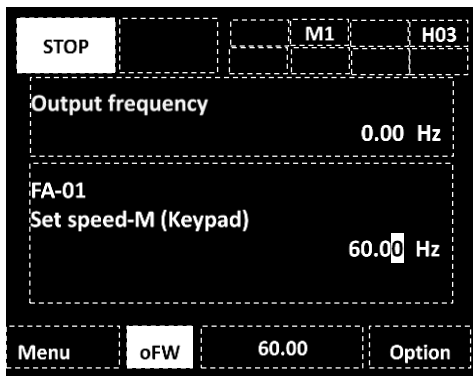

■ Frequency reference

- Use the up, down, left and right arrow keys to change the frequency reference setting by [FA-01] “Main speed reference setting or monitor” or [Ab110] “Multi speed 0 setting, 1st motor”.

■ Parameter

Parameter	Details	Setting data
[AA101]	Main speed input source selection, 1st-motor	07
[FA-01]*)	Main speed reference setting or monitor	0.00Hz
[Ab110]*)	Multi-speed 0 setting, 1st-motor	0.00Hz

\*) While [AA101] = 07, a change made in either [FA-01] or [Ab110] will be automatically reflected in the other. When no change can be made or is reflected in [FA-01], the operator keypad is not specified as a command source by the terminal function or [AA101].

- The frequency setting value should be set to other than 0.00.
- When the main speed command can be set on the keypad, the output terminal 010[FREF] turns ON.

■ Run command source 1

3.4 Run key using on the keypad

- Select [AA111] = 02: Keypad’s RUN-key.



RUN key (start)      STOP key (stop)

■ Run/stop command

Press the RUN key and STOP key on the operator keypad to start and stop the inverter, respectively.

■ Parameter

Parameter	Details	Setting data
[AA111]	RUN command input source selection,1st-motor	02

- When the RUN command can be input from the keypad, the output terminal [REF] “Run command = Keypad” turns ON.
- In addition, when the RUN command is input, not limited to the RUN key on the keypad, the output terminal 031[FR] starting contact signal turns ON.

■ Frequency source 2

3.5 Multispeed terminals command

- While multispeed command is off, the speed commands follow the parameter setting [AA101].
- To use multispeed 0, select [AA101] = 07 : Parameter Setting.

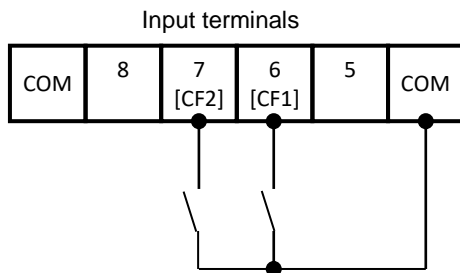

- Frequency reference source
- Change the frequency reference by turning ON/OFF from multispeed input terminals 003[CF1] and 004[CF2].

■ Parameter

Parameter	Details	Setting data
[AA101]	Main speed input source selection, 1st-motor	07
[FA-01]*1)	Main speed reference setting or monitor	0.00Hz
[Ab110] *1)	Multi-speed 0 setting, 1st-motor ([CF1]OFF/[CF2]OFF)	0.00Hz
[Ab-11] *2)	Multi-speed 1 setting ([CF1]ON/[CF2]OFF)	0.00Hz
[Ab-12] *2)	Multi-speed 2 setting ([CF1]OFF/[CF2]ON)	0.00Hz
[Ab-13] *2)	Multi-speed 3 setting ([CF1]ON/[CF2]ON)	0.00Hz
[CA-06]	Input terminal [6] function([CF1])	003
[CA-07]	Input terminal [7] function([CF2])	004

\*1) While [AA101] = 07, a change made in either [FA-01] or [Ab110] will be automatically reflected in the other. When no change can be made nor is reflected in [FA-01], the operator keypad is not specified as a command source by the terminal function or [AA101].

\*2) Set the frequency value for multispeed selection.

■ Run command source 2

3.6 Operate using FW/RV terminal

- Select [AA111] = 00 : [FW]/[RV] terminal.

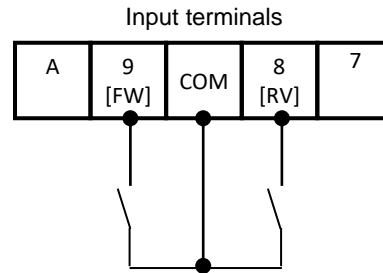

- Run/stop command
- Run or stop by turning either input terminal 001[FW] or input terminal 002[RV] ON/OFF.

■ Parameter

Parameter	Details	Setting data
[AA111]	RUN command input source selection, 1st-motor. (select 00([FW]/[RV] terminal)	00
[CA-09]	Input terminal [9] function (Set to [FW])	001
[CA-08]	Input terminal [8] function (Set to [RV])	002

■ Frequency source 3

3.7 Potentiometer frequency reference

- Select [AA101] = 01 : Terminal[Ai1].
- \* Select voltage input (0 to 10V) for Ai1 slide switch SW1 on control circuit board.

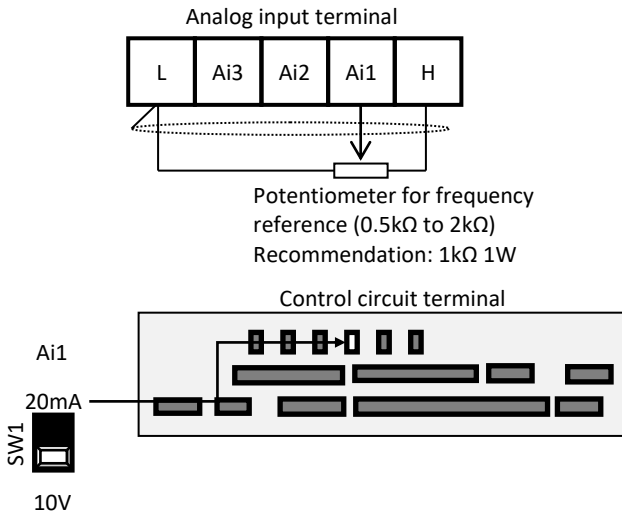

■ Frequency reference

- Adjust the position of the knobs on the potentiometer to change the frequency reference value.

■ Parameter

Parameter	Details	Setting data
[AA101]	Set as frequency reference for Ai1 input terminal.	01

■ Regarding Frequency reference input from the Ai2 terminal

- The Ai2 terminal is current input (4 to 20 mA) in factory setting. It can switch to voltage input by setting the Ai2 slide switch to the voltage side (10V) on the control circuit terminal.
- When setting the voltage input to 0 to 10 V, please change the parameter [Cb-15] from the initial value of 20.0% to 0.0%.  
To set the frequency reference with the Ai2 terminal input, select 02(Terminal[Ai2]) on the parameter [AA101].

■ Run command source 3

3.8 Operate using 3WIRE terminal

- Select [AA111] = 01 : 3-wire.  
In this section, 3WIRE functions are assigned into the input terminals.
- \* Terminal 7[CA-07] = 016; terminal 8[CA-08] = 017; terminal 9[CA-09] = 018;  
(Note: When the input terminal 017[STP] function is assigned, it becomes NC contact input)

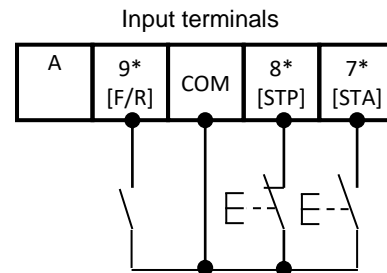

■ Run/stop command

- When the input terminal 016[STA] is turned on while the input terminal 017[STP] is on, operation starts.
- If the input terminal 017[STP] is turned off from the operating status, the motor will decelerate to a stop. To restart, turn on the input terminal 017[STP] again and turn on the input terminal 016[STA] terminal.
- The rotation direction is selected with the input terminal 018[F/R] terminal.

■ Parameter

Parameter	Details	Setting data
[AA111]	Set the RUN command for 3WIRE function.	01
[CA-07]	The terminal 7 is [STA].	016
[CA-08]	The terminal 8 is [STP].	017
[CA-09]	The terminal 9 is [F/R].	018

Example for adjusting I/O terminals 1

3.9 Adjust the analog input (Ai1/Ai2)

E.g.1) Adjust operation ( The frequency reference is set by [Ai1] )

- The frequency reference range corresponding to the analog input can be set arbitrarily.

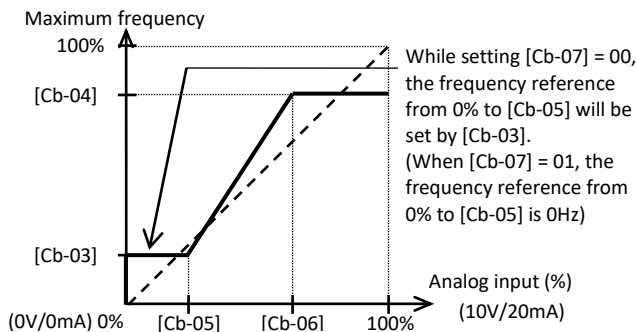

Parameter

Parameter		Details
Ai1	Ai2	
[Cb-03]	[Cb-13]	Set the start frequency when the analog input is [Cb-05]. Set the ratio (%) with the maximum frequency as 100%.
[Cb-04]	[Cb-14]	Set the end frequency when the analog input is [Cb-06]. Set the ratio (%) with the maximum frequency as 100%.
[Cb-05]	[Cb-15]	Set the start ratio (%) between analog input 0 to 10 VDC/0 to 20 mA.
[Cb-06]	[Cb-16]	Set the end ratio (%) between analog input 0 to 10 VDC/0 to 20 mA.
[Cb-07]	[Cb-17]	Sets whether the frequency reference from 0% to [Cb-05]/[Cb-15] is set to 0% or [Cb-03]/[Cb-13].

E.g.2) Fine setting ( The frequency reference is set by [Ai1] )

- If there is a deviation between the analog input and the frequency reference in the above [Cb-03] to [Cb-06] adjustment, fine adjustment is possible as follows. At this time, set [Cb-03] to [Cb-06] to the default values as possible. Typically, the gain / bias is adjusted within a few percent.

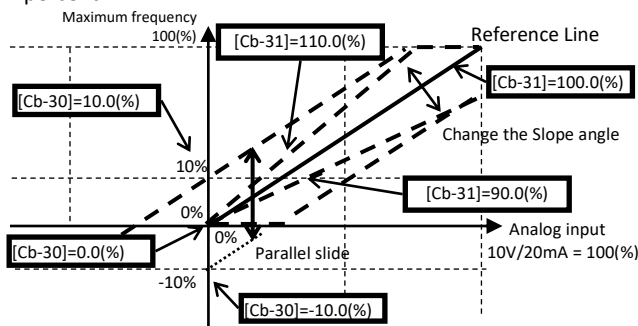

Parameter

Parameter		Details
Ai1	Ai2	
[Cb-30]	[Cb-32]	Fine adjustment of the analog input 0 V / 20 mA point is performed by adding the bias value to the frequency reference. Set the ratio (%) with the Maximum frequency as 100%.
[Cb-31]	[Cb-33]	As shown above figure, fine adjustment is performed by multiplying the slope of the reference line by the gain. Set the ratio (%) based on the ( Maximum frequency / analog input (10V / 20mA) ) = 100%.

\*) The voltage/current input is switched by the slide switch on the board.

\*) For the adjustment of Ai2, read the above parameter Ai1 as Ai2.

Example for adjusting I/O terminals 2

3.10 Adjust the analog output (Ao1/Ao2/FM)

E.g.) Adjust operation ( [Ao1] outputs the output frequency )

- Adjust the actual analog output by adding the bias [Cd-23] to the analog output when the output data is 0%.

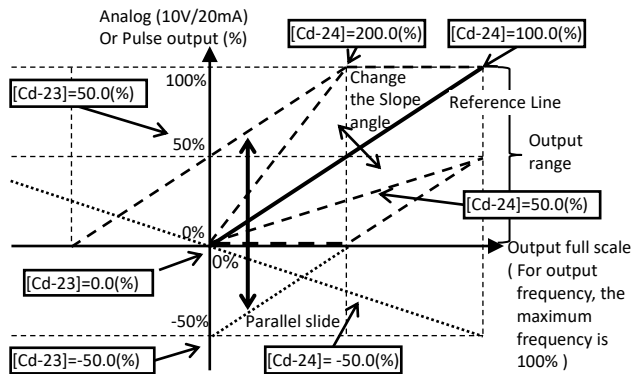

- Then, adjust the slope by multiplying the gain [Cd-24] to the reference line that (Analog output(10V/20mA)/ output data full scale) is 100%, adjust the analog output when the output data is 100%.

Parameter

Parameter		Details
Ao1	Ao2	
[Cd-23]	[Cd-33]	The actual analog output is adjusted by adding a bias to the analog output when the output data is 0%. Set the ratio (%) based on analog output (10V / 20mA) = 100%.
[Cd-24]	[Cd-34]	The {analog output (10V / 20mA) / output data full scale} = 100% is used as the reference line, and the actual analog output is adjusted by multiplying the slope by a gain.

- The output form of the FM terminal can select PWM output or digital frequency output by [Cd-01]. At PWM output, the pulse duty =  $t/T$  (%) is constant ( $T = 6.4$  ms), and  $t/T$  (%) = 100% at full scale of output data. At digital frequency output,  $t/T$  (%) is fixed at 50%, and the output pulse frequency at full scale output data is set by [Cd-02].

Parameter		Details
FM		
[Cd-13]		Adjust the actual pulse output by adding a bias to the pulse output when the output data is 0%. For PWM output, set the ratio (%) based on the output duty ( $t/T$ ) (%) = 100%. For digital frequency output, set the ratio based on [Cd-02] Set frequency = 100% (%).
[Cd-14]		{Pulse output (%) / Output data full scale = 100%} is used as the reference line, and the actual pulse output is adjusted by multiplying the slope by a gain.

\*) Analog output terminals Ao1/Ao2 can be switched to voltage or current output with the slide Switch on the control circuit terminal. Factory setting is Ao1=voltage output and Ao2=current output.

\*) Adjustment for analog output Ao1/Ao2/FM are set with [Cd-01] to [Cd-35]. Refer to the P1 User's Guide for details. (Note: In Ver2.02 or later, the initial value of Ao2 is 4 to 20 mA current output, and the [Cd-34] setting value has been changed from 100% to 80%. When using the analog output, be sure to check the related parameters and the slide switch on the board. And also, refer to the supplementary explanation at the end of guide. )

■ Example for adjusting I/O terminals 3

3.11 Adjust the analog input (Ai3)

E.g.) Adjust operation ( The frequency reference is set by [Ai3])

- The frequency reference range corresponding to the analog input can be set arbitrarily.

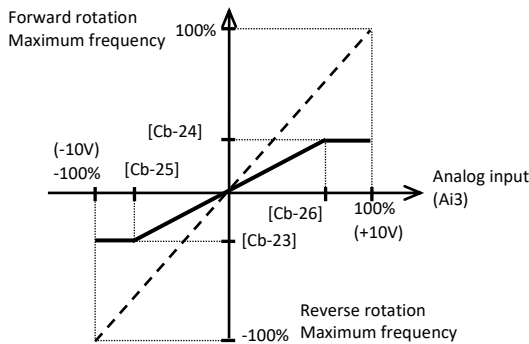

■ Parameter

Parameter	Details
Ai3	
[Cb-23]	Set the start frequency when the analog input is [Cb-25]. Set the ratio (%) with the maximum frequency as 100%.
[Cb-24]	Set the end frequency when the analog input is [Cb-26]. Set the ratio (%) with the maximum frequency as 100%.
[Cb-25]	Set the start voltage between the analog input -10V and 10V in the ratio (%) corresponding to -100% to 100%.
[Cb-26]	Set the end voltage between the analog input -10V and 10V in the ratio (%) corresponding to -100% to 100%.

E.g.2) Fine setting ( The frequency reference is set by [Ai3] )

- If there is a deviation between the analog input and the frequency reference in the above [Cb-23] to [Cb-26] adjustment, fine adjustment is possible as follows. At this time, set [Cb-23] to [Cb-26] to the default values as possible. Typically, the gain / bias is adjusted within a few percent.

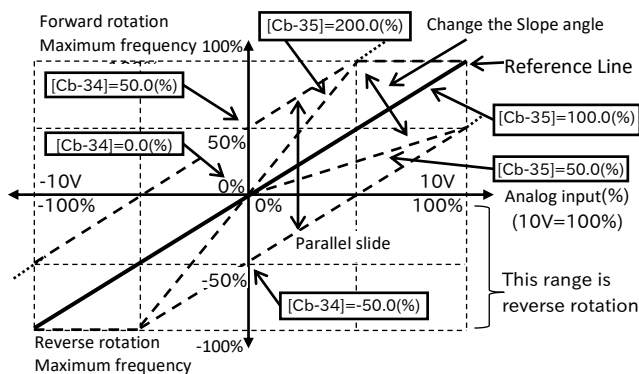

■Parameter

Parameter	Details
Ai3	
[Cb-34]	Fine adjustment of the analog input 0 V point is performed by adding the bias value to the frequency reference. Set the ratio (%) with the Maximum frequency as 100%. If the frequency reference is negative, the rotation is reverse.
[Cb-35]	As shown above figure, fine adjustment is performed by multiplying the slope of the reference line by the gain. Set the ratio (%) based on the ( Maximum frequency / analog input (10V) ) = 100%.

■ Example for adjusting I/O terminals 4

3.12 Input terminal chatter prevention

- Set a response time for input terminal to prevent from a malfunction due to noise or/and chatter.

Operation of the input terminal 1  
Operation of the internal functions

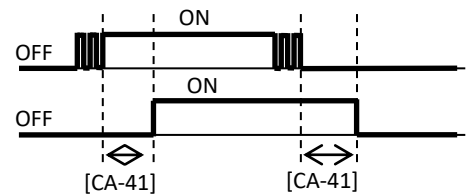

■ Parameter

Input terminal	Response time	Input terminal	Response time
1	[CA-41]	7	[CA-47]
2	[CA-42]	8	[CA-48]
3	[CA-43]	9	[CA-49]
4	[CA-44]	A	[CA-50]
5	[CA-45]	B	[CA-51]
6	[CA-46]		

■ Example of adjusted I/O terminals 5

3.13 Output terminals stabilization

- Set the delay time to stabilize an output terminal from a sensitive reaction of internal functions.

Selected output function  
Operation of the output terminal 11

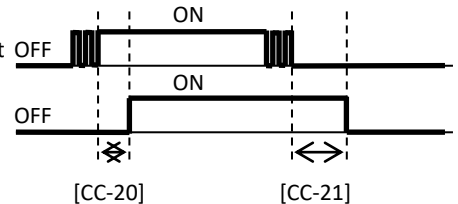

■Parameter

Output terminal	On-delay time	Off-delay time
11	[CC-20]	[CC-21]
12	[CC-22]	[CC-23]
13	[CC-24]	[CC-25]
14	[CC-26]	[CC-27]
15	[CC-28]	[CC-29]
16A-16C	[CC-30]	[CC-31]
AL1-AL0/ AL2-AL0	[CC-32]	[CC-33]

## Chapter 4 Settings

### 4.1 Keypad overview

#### 4.1.1 How to use the keypad

✧ Image colour may differ from the real product.

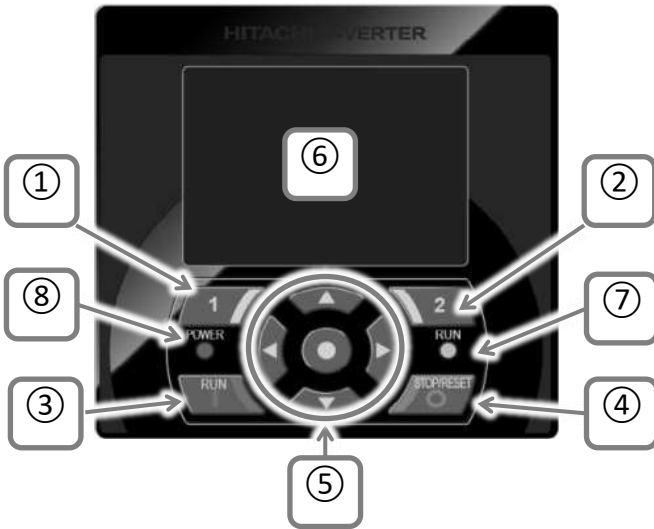

Number	Name	Description
①	F1 key	Transition to home, cancel, etc. Function of the key is indicated at the bottom left of the screen.
②	F2 key	Save data, etc. Function of the key is indicated at the bottom right of the screen.
③	RUN key	When this key is valid, press this key to start the motor.
④	STOP/RESET key	The motor is decelerated and stopped. Or perform the trip reset of the inverter.
⑤	UP/DOWN/LEFT/RIGHT keys & SEL key (centre)	Use the Up/Down/Left/Right keys to change the screen or select/change the data. Press the SEL key to determine the data selection.
⑥	Monitor screen	Display the parameters and values, the inverter statuses, etc..
⑦	RUN LED	Turns ON while RUN command is in execution.
⑧	POWER LED	Turns ON while the keypad is powered-on.

#### 4.1.2 Display mode ⑥

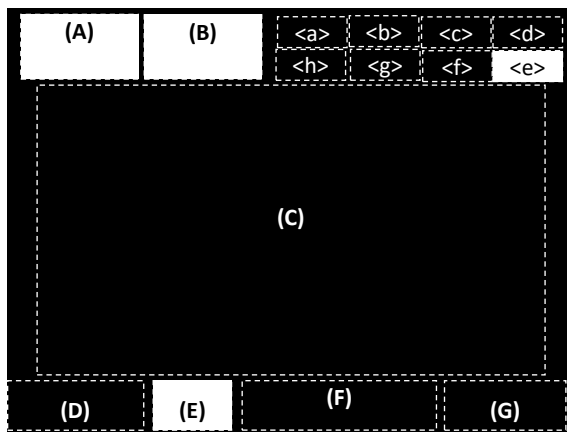

Number	Description
(A)	Operation status.
(B)	Warning status.
(C)	Data/parameters.
(D)	Function assigned to F1 key.
(E)	Function of RUN key.
(F)	Frequency reference, Torque reference, Inverter Name, Clock, etc. When the F2 key function is "option", the display contents can be selected.
(G)	Function assigned to F2 key.

Number	Name	Description
<a>	Pow	Type of power supply (Input).
<b>	SET	SET terminal status for 1st/2nd motor setting.
<c>	Prm	Parameter display mode.
<d>	No.	Screen number.
<e>	STO	Functional safety STO status.
<f>	Cntrl	Control mode.
<g>	EzSQ	EzSQ program status.
<h>	Spcl	Special function execution.

✧ For more detail, refer to “Chapter 5.2 Confirming the status” or P1 users’ guide.

4.1.3 Monitor mode

✧ For screens not described below, refer to P1 User's Guide. ✧ Pressing F1 key will return to any monitor screen.

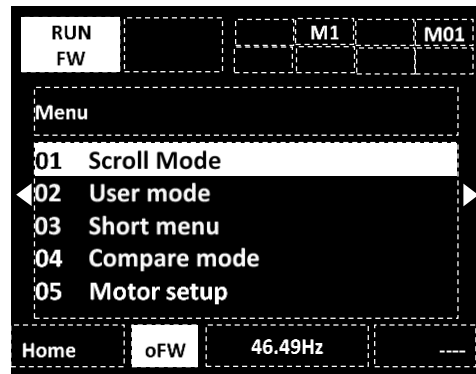
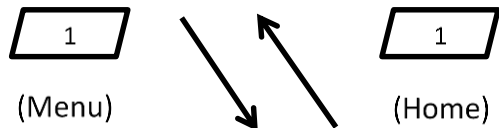
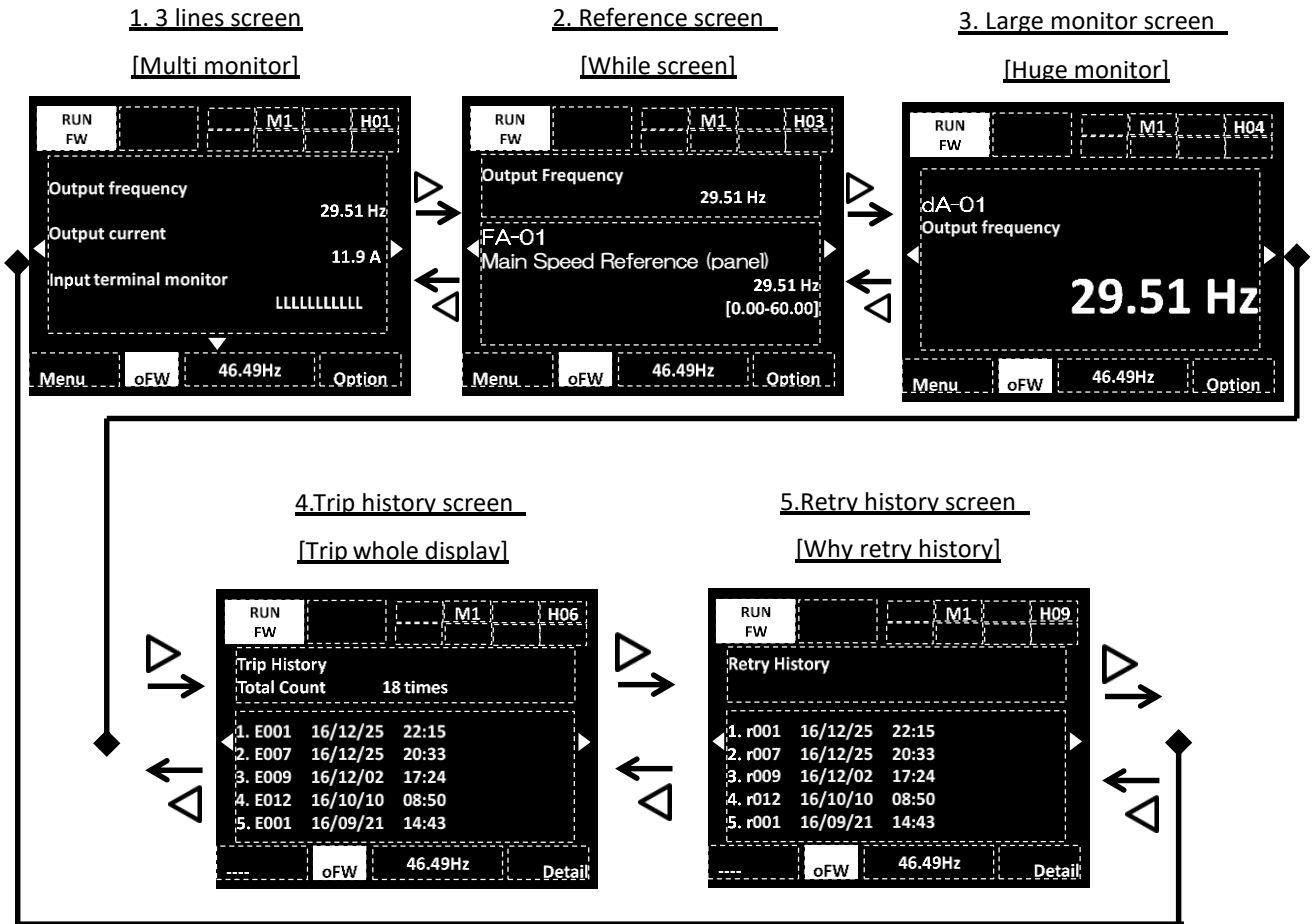

(Note: function 02 to 05 are added from Ver2.02)



**4.1.3.1. Reference screen (parameter setting)**

- How to change parameter value.

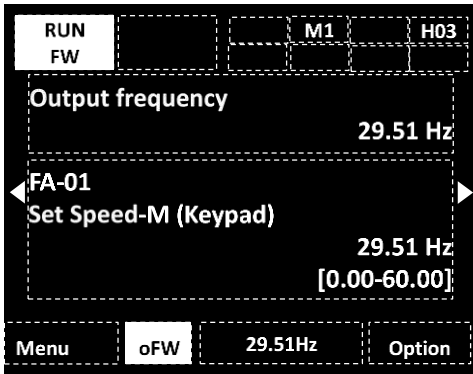

Press the SEL (O) key.



An area in the screen will be highlighted.

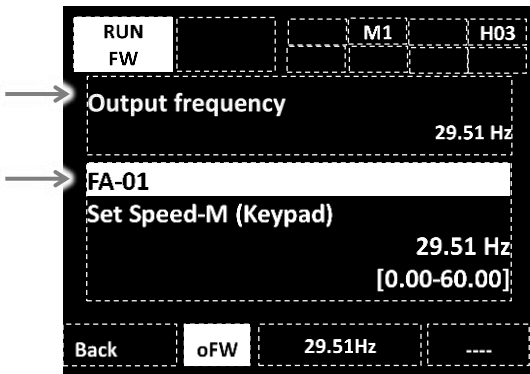

With UP/DOWN ( $\Delta \nabla$ ) keys select either parameter or monitor area and it will be highlighted.



If SEL (O) key is pressed, the parameter code can be changed.

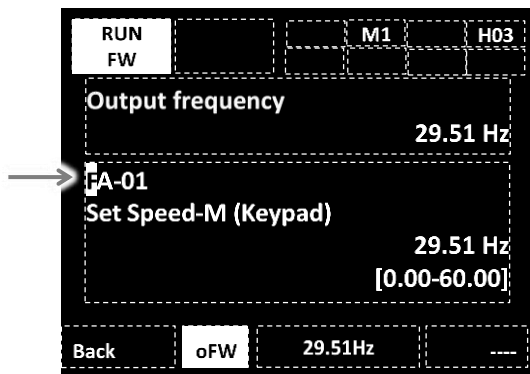

Using UP/DOWN/LEFT/RIGHT ( $\Delta \nabla \leftarrow \rightarrow$ ) keys the parameter code to be monitored can be changed, pressing again the SEL (O) key give access to the function parameter. Press F1 key to return back.

- In case of changing numeric type parameter value.

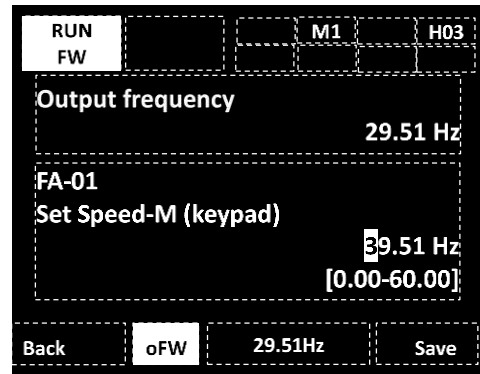

With UP/DOWN/LEFT/RIGHT ( $\Delta \nabla \leftarrow \rightarrow$ ) keys change the parameters value,

**And then press the SEL (O) key to save the changes.**

- In case of changing selection type parameter value:  
The lower area of the display shows the selectable item.

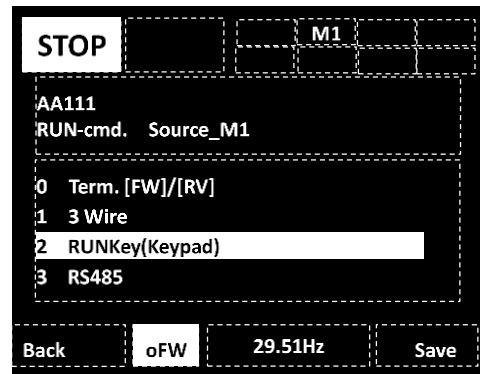

With UP/DOWN ( $\Delta \nabla$ ) keys select one from selectable items.

**And then press the SEL (O) key to save the selection.**

**4.1.3.2 3 lines monitor and Large monitor**

- How to change monitor items.

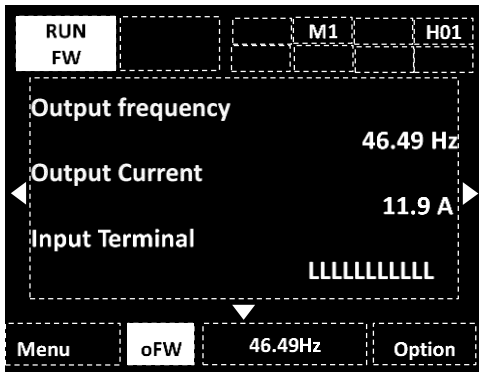

Press the SEL (O) key while on the 3 lines screen, highlighting the first line as result.

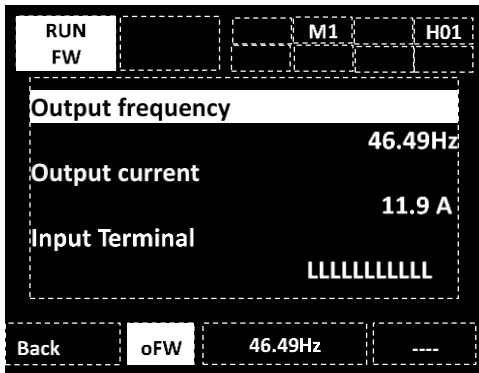

Then with UP/DOWN (Δ∇) is possible to highlight the one desired of the three monitors.



Pressing the SEL (O) key, the code can be accessed.

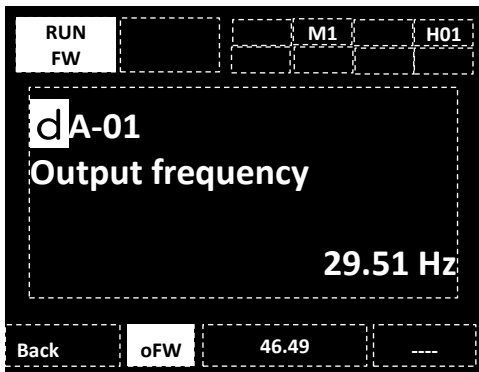

Making use of UP/DOWN/LEFT/RIGHT (Δ∇◀▶) keys, the code of the parameter to be monitored can be changed, and then with the SEL (O) key confirm the change. Press F1 key to return back. The top of "3 lines monitor" is same as the display setting for "Large monitor".

**4.1.3.3 Trip history screen**

- On tripping event.

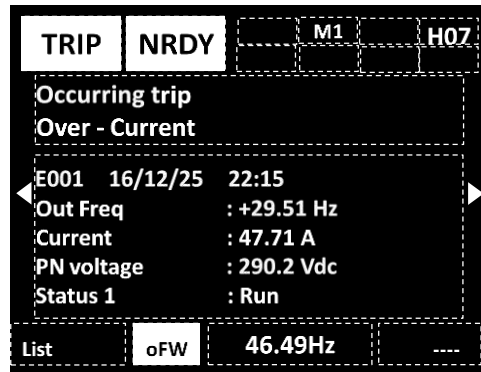

With UP/DOWN (Δ∇) keys, the trip status can be confirmed. Also, the background will become red.

- In case checking trip history:

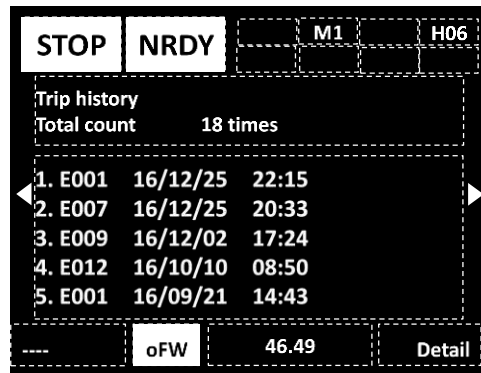

In the Trip history screen press the SEL (O) key, and with UP/DOWN (Δ∇) keys highlight a history, then press SEL (O) key to access the details regarding that trip status.

- \*) For more details about the detailed history, refer to "Chapter 5 FAQ/Troubleshooting".
- \*) Put a battery for using clock function.

**4.1.3.4 Retry history screen**

Please refer to the P1 User's Guide for details.

#### 4.1.4 Doing a test run...

- This explains the method to how to do a test run using the keypad.

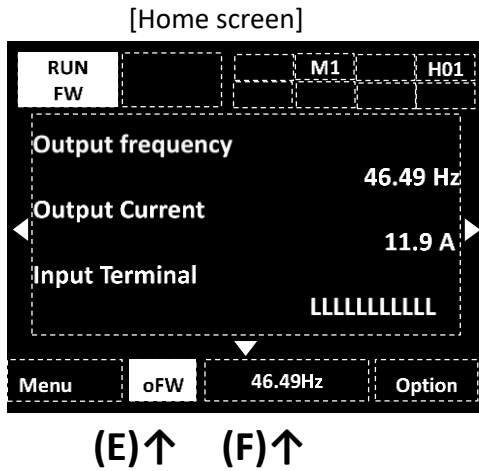

##### 4.1.4.1 Confirm the RUN command.

- In the (E) of the upper illustration, when is displayed FW or RV, the RUN key of the keypad is enabled.  
⇒Go to [4.1.4.2]

※In the cases that is not displayed, and want to operate from the keypad, or want to change the RUN command reference to FW terminal, is necessary to change the RUN command selection.

⇒Go to [4.1.4.4 Run Command reference change]

##### 4.1.4.2 Confirm the frequency reference status.

- In the upper illustration, in the (F), when values other than 0.00Hz are displayed, the frequency reference is already set. ⇒Go to [4.1.4.3]

※In the case that 0.00Hz is displayed in the (F), it is necessary to change the value of the frequency reference. In the case that you want to change to an analog input or other input source, the frequency reference input source selection must be changed.

⇒Go to [4.1.4.5]

- ※ When the unit of the display of (F) is other than “Hz”, the display data of (F) is not the frequency reference.  
Press F2 key ⇒ Select [02 Lower center data] and press SEL(o) key ⇒ Selecting [00 Set Frequency] and press F2 key (Save), the display data in (F) becomes the frequency reference.

#### 4.1.4.3 Start the output by pressing the RUN key and the motor will accelerate.

- ※When the motor does not rotate, refer to the “Chapter 5 FAQ/Troubleshooting”.

##### 4.1.4.4 RUN command reference change

- ① Press the RIGHT(▶) key to display the parameter setting screen. After that, when the SEL (o) key is pressed twice, the parameter section of the parameter setting screen blinks.

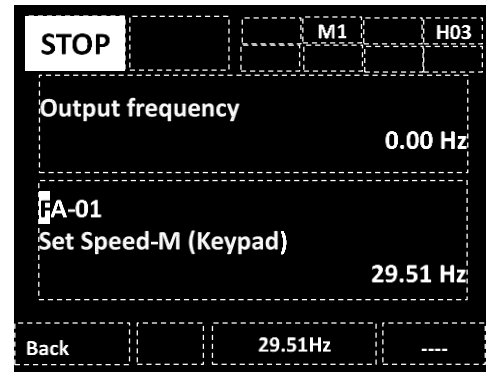

- ② Change the code with UP/DOWN/LEFT/RIGHT (▲▼◀▶) keys to [AA111].

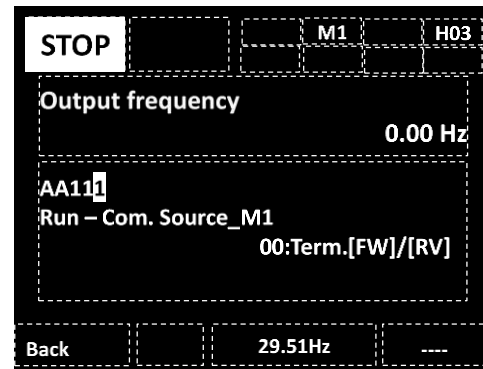

- ③ Press the SEL(O) key and then with UP/DOWN(▲▼) keys select the RUN operation to be executed between all the choices. In this case [02:RUNkey(Keypad)] is the one selected.

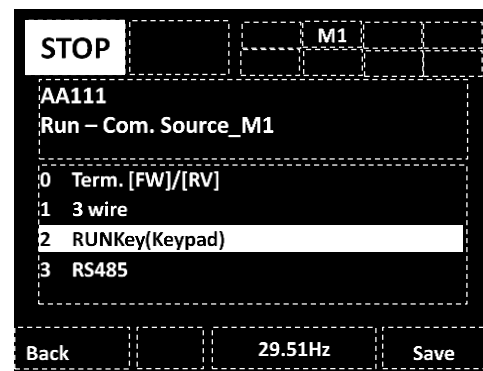

- ④ To save the change press the SEL (O) key and then in the position (E) FW or RV should be displayed. Press F1 key, the screen return to the parameter setting screen.  
⇒Go to [4.1.4.2]

**4.1.4.5 Frequency reference change**

- ① Press the RIGHT (▶) key and after moving to the parameter setting screen, press the SEL (O) key, the parameter section of the parameter setting screen will blink.

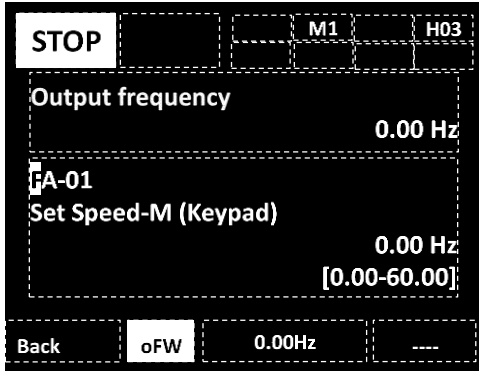

- ② With UP/DOWN/LEFT/RIGHT(Δ▽◀▶) keys change the code to [FA-01], then [Main speed reference (keypad)] shall be displayed, the frequency reference can be changed.  
⇒Go to ③  
If the displayed screen is different, change the frequency reference source. ⇒Go to ⑤

- ③ Press the SEL(O) key, with UP/DOWN/LEFT/RIGHT(Δ▽◀▶) keys change the frequency value.

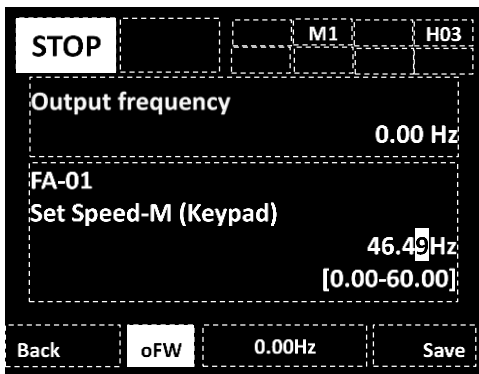

(F)↑

- ④ To save the change press the F2 key (save), and after that in the position (F) should be displayed the frequency reference. Press F1 key, the screen return to the parameter setting screen. ⇒Go to [4.1.4.3]

※The parameter [FA-\*\*] are automatically saved into non-volatile memory without pressing the F2 key (save). When the power is turned on again, the last saved parameter is displayed.

- ⑤ With UP/DOWN/LEFT/RIGHT(Δ▽◀▶) keys change the parameter code to [AA101].

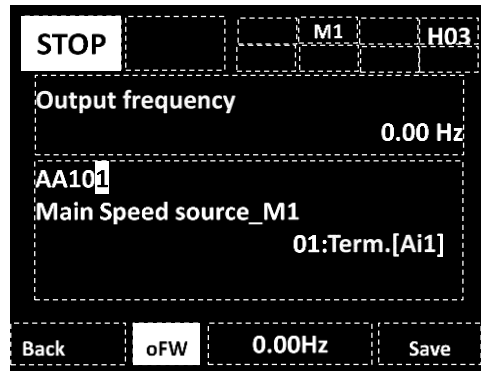

- ⑥ Press the SEL(O) key and with UP/DOWN(Δ▽) keys, select the frequency reference source to be used. [07:Keypad] is selected in this case.

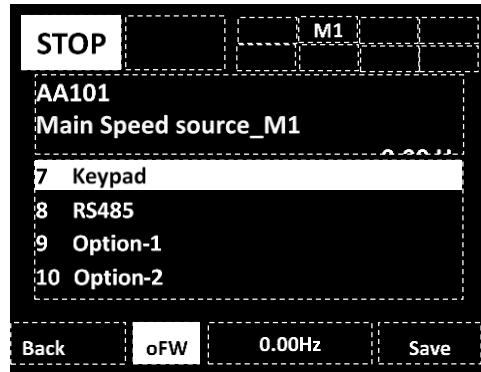

- ⑦ When the F2 key (save) is pressed to save changes, the current frequency reference is displayed at the (F) position. Press F1 key, the screen return to the parameter setting screen.  
⇒Go to ①

4.1.5 How to copy data.

Data can be stored in the keypad and then copied to other inverter unit. It is strongly recommended to make backup of the data just in case.

Refer to P1 user’s guide for a more detailed explanation.

- ① Select Read/Write function menu

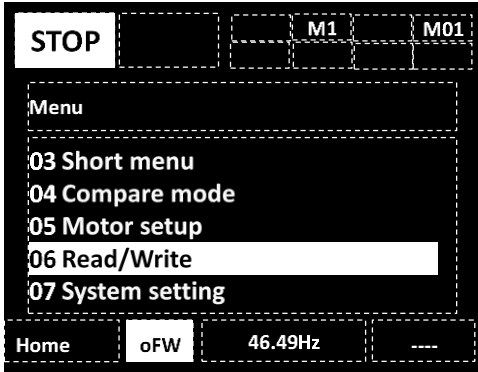

- ② "Read" function is used for storing the data from the inverter to the keypad.
- ②' "Write" function is used for copying the data stored in the keypad to the inverter

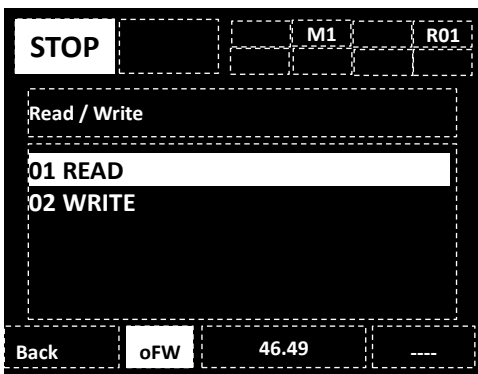

For more information, refer to the P1 user’s guide.

4.1.6 System configuration of the keypad

With 07 System setting, you can set and adjust keypad related parameters.

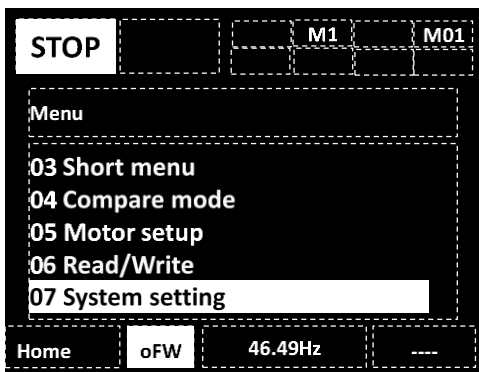

- Available actions in the system setting

No	Name	Memo
01	Language selection	Changes the language setting.
02	Dimming	Controls the brightness of operator keypad screen.
03	Automatic light off time*1)	Controls the time to automatically light off the screen.
04	Dimming at light off *1)	Controls the brightness when the screen is automatically lit off.
05	Automatic home transition time	Sets the time to automatically return to the home screen.
06	Initial home screen selection	Sets the screen that is displayed upon power-on and the home screen at automatic home transition. Even if the input terminal function 102[DISP] is turned on, it is fixed to the home screen set here.
07	Read lock	Limits the reading of data.
08	Blinking during trip	Sets whether blinking is performed or not during trip.
09	Date and time*2)	Configures settings of time, display format, and battery level warning.
10	Battery level warning	Displays a warning message when the battery runs out.
11	Color setting	Sets the background color.
12	Basic inverter information monitor	Checks information of the main unit.
13	Selection of connected model	Select the inverter series to be connected. (Currently only SJ-P1)
14	Operator keypad version	Displays the version of the operator keypad.
15	Initialization of operator keypad	Initializes the operator keypad.
16	Self-check mode	Operates self-check mode.
17	Remote mode switching	If this setting is enabled, when the F1 key on the home screen is pressed for 1 second or more, you can switch the frequency reference and RUN command to commands issued from the operator keypad.
18	Reserve	Do not change the setting from OFF.

\*1) The auto backlight-off function will deactivate during in trip status until trip reset. For more information, refer to the P1 user’s guide.

\*2) Battery is required to use date and time function. Recommend: Maxell, Ltd. CR2032, 3V  
The battery is to be replacing every two years while the inverter is power off.

4.1.7 How to check parameters in scroll mode

In scroll mode, parameter can be change while monitoring. To set parameters by Reference screen, refer to “4.1.3.1 Reference screen (parameter setting)”

4.1.7.1 Try scroll mode

① Press the F1 key [Menu] on [home] screen

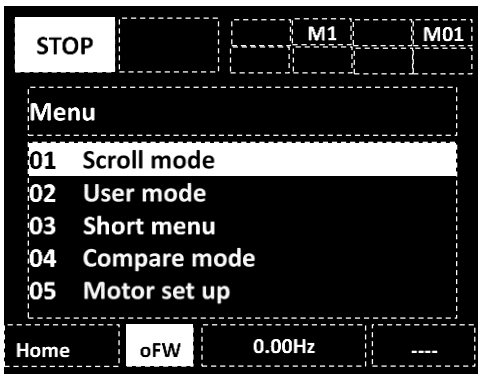
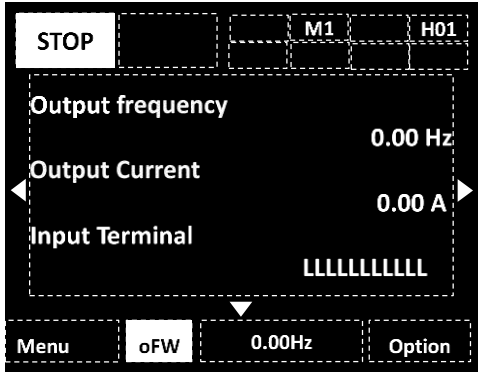

② With UP/DOWN (Δ▽) key select scroll mode to display scroll menu, then, press SEL (0) key to display scroll menu screen.

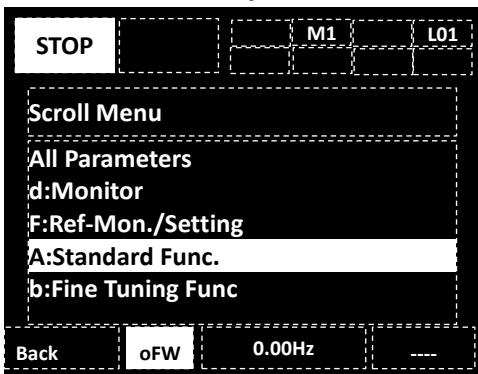

③ Select the monitor group with UP/DOWN (Δ▽) key and press SEL (0) key, then the screen is changed to parameter list screen. In the following example, selecting “A:Standard Func.” then press SEL (0) key.

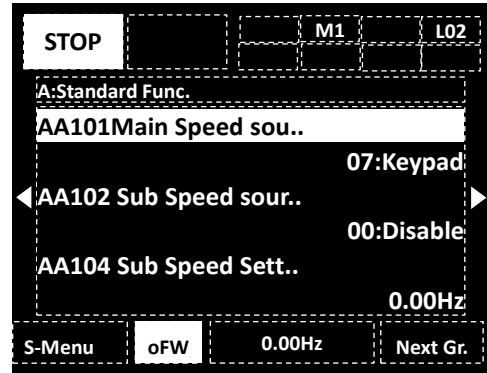

④ Select a parameter to change with UP/DOWN (Δ▽) key and press SEL (0) key, then the screen go to setting screen.



⑤-1 When the choice is a selectable parameter, press UP/DOWN (Δ▽) key to select data. Then press F2 (Save) key, the data is stored and the screen return to parameter list screen shown above.

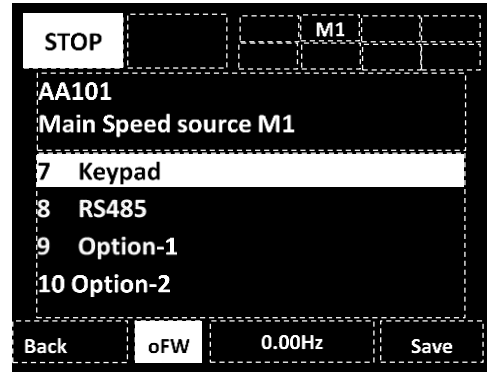

⑤-2 When the choice is the numerical value parameter, press UP/DOWN/LEFT/RIGHT (Δ▽◀▶) key to change data. Then press F2 (Save) key, the data is stored and the screen return to parameter list screen shown above.

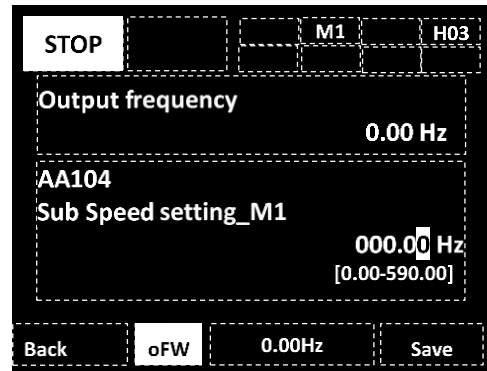

(Tips)

- Press F1 (Back) key to return to parameter list without storing the parameter change.
- Parameter selected for reference screen is show in upper line on ⑤-2.
- When the scroll mode is set to the initial display screen at power on with the setting of "07 System setting"-> "06 Initial Display", the dA-\*\* screens such as dA-01, dA-02, etc. are displayed.

**4.1.7.2 Group Jump Function**

① Press LEFT/RIGHT (◀▶) key to jump to 1st parameter of each group.

② With the F2 key, it is possible to jump to the detailed subgroup screen (AA, Ab, etc.).  
A group for example : ...⇒AA⇒Ab⇒AC⇒...⇒AJ⇒AA⇒...

(...⇒All parameters⇒d:Monitor⇒F:Command  
Monitor/Setting⇒...⇒U:Initial Setting、 PDN⇒All  
Parameters⇒...)

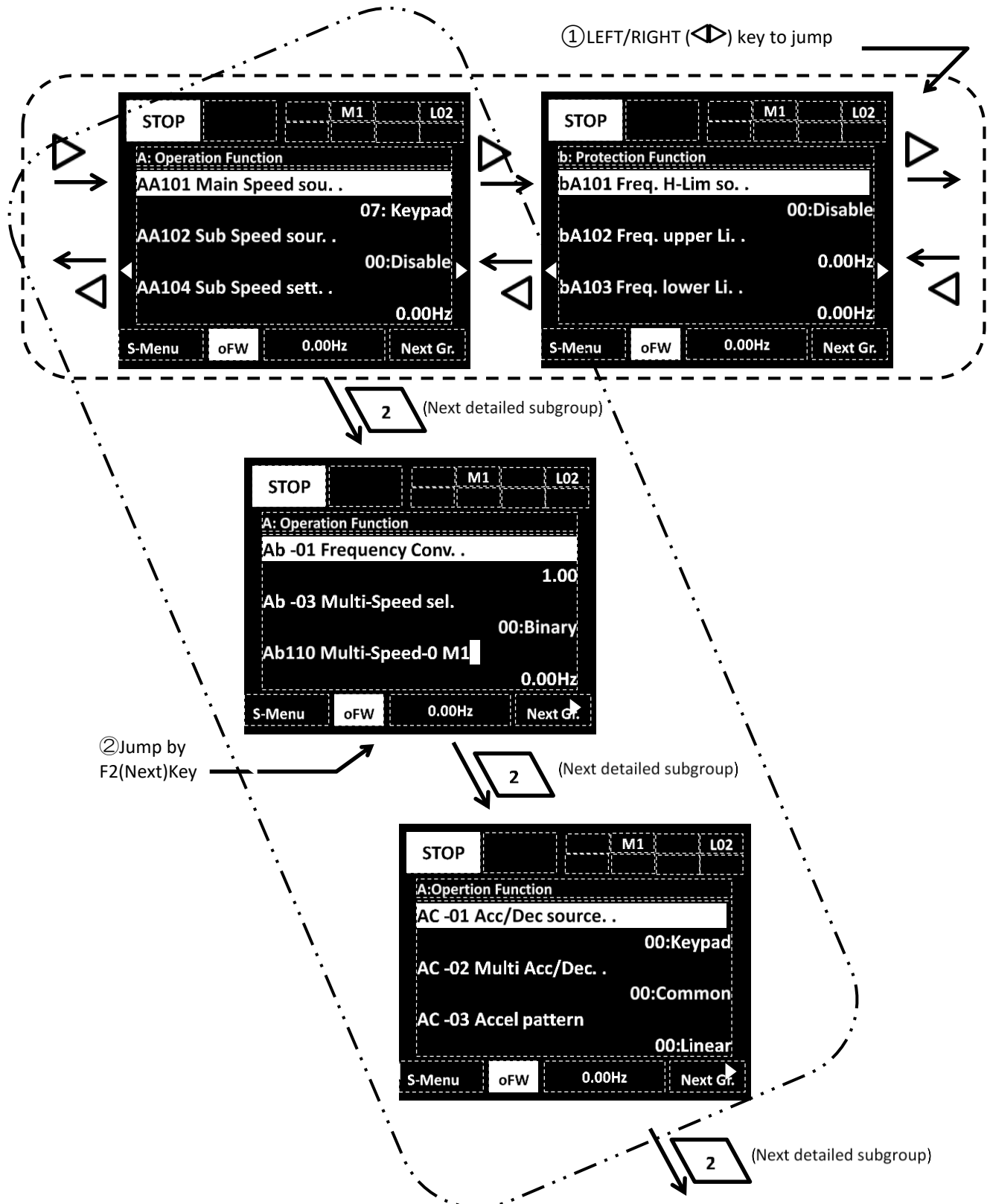

[dA-01] to [dA-41]

[dA-42] to [dA-83]

## 4.2 Monitor naming (Nomenclature)



## 4.3 Description of monitor functions

✳For more detail, refer to P1 user's guide.

## Monitor data list

■ Monitor mode (d code)

Code/Name	Range (unit)
<b>dA-01</b> Output frequency monitor	0.00 to 590.00(Hz) <Actual frequency output>
<b>dA-02</b> Output current monitor	0.00 to 655.35(A) ( 0.0 to 6553.5(A) (P1-1600H or above) )
<b>dA-03</b> Rotation direction monitor	0(stop) / 1 (0Hz output) / 2(forward)/ 3(reverse)
<b>dA-04</b> Frequency reference monitor (after calculation) *2)	-590.00 to 590.00(Hz) <as target value>
<b>dA-06</b> Output frequency scale conversion monitor	0.00 to 59000.00(Hz)
<b>dA-08</b> Detect speed monitor	-590.00 to 590.00(Hz) <Encoder feedback required>
<b>dA-12</b> Output frequency monitor (signed)	-590.00 to 590.00(Hz)
<b>dA-14</b> Frequency upper limit monitor	0.00 to 590.00(Hz)
<b>dA-15</b> Torque reference monitor (after calculation) *2)	-1000.0 to 1000.0(%) <Torque control mode required>
<b>dA-16</b> Torque limit monitor	0.0 to 500.0(%)
<b>dA-17</b> Output torque monitor *1)	-1000.0 to 1000.0(%)
<b>dA-18</b> Output voltage monitor (RMS)	0.0 to 800.0(V)
<b>dA-20</b> Current position monitor	When [AA121]≠10 or [AA123]≠03 -536870912 to +536870911 (pls) Parameter setting other than above -2147483648 to +2147483647(pls)
<b>dA-26</b> Pulse train position deviation monitor	-2147483647 to +2147483647(pls)
<b>dA-28</b> Pulse count monitor	0 to 2147483647(pls)
<b>dA-30</b> Input power monitor	0.00 to 655.35(kW) (0.0 to 6553.5(kW)(P1-1600H or above ))
<b>dA-32</b> Accumulated input power monitor	0.0 to 1000000.0 (kWh)
<b>dA-34</b> Output power monitor	0.00 to 655.35(kW) (0.0 to 6553.5(kW)(P1-1600H or above ))
<b>dA-36</b> Accumulated output power monitor	0.0 to 1000000.0 (kWh)
<b>dA-38</b> Motor temperature monitor	-20.0 to 200.0 (degree Celsius)
<b>dA-40</b> DC bus voltage monitor	0.0 to 1000.0 (VDC)
<b>dA-41</b> BRD load rate monitor	0.00 to 100.00 (%)

Code/Name	Range (unit)
<b>dA-42</b> Electronic thermal load rating monitor (MTR)	0.00 to 100.00(%)
<b>dA-43</b> Electronic thermal load rating monitor (CTL)	
<b>dA-45</b> Safety STO monitor	00(no input)/01(P-1A)/02(P-2A)/03(P-1b)/04(P-2b)/05(P-1C)/06(P-2C)/07(STO)
<b>dA-46</b> Safety option hardware monitor	0000 to FFFF
<b>dA-47</b> Safety option function monitor	00(no input )/ 01(STO)/02(SBC)/03(SS1)/04(SLS)/05(SDI)/06(SSM)
<b>dA-50</b> Control terminal type	00(P1-TM)/02(P1-TM2)/15(not connect)
<b>dA-51</b> Input terminal monitor	LLLLLLLLLL to HHHHHHHHHH [L:OFF/H:ON] [Left](B)(A)(9)(8)(7)(6) (5)(4)(3)(2)(1)[Right]
<b>dA-54</b> Output terminal monitor	LLLLLLL to HHHHHHH [L:OFF/H:ON] [Left](AL)(16A)(15)(14)(13) (12)(11)[Right]
<b>dA-60</b> Analog input/output status monitor	AAAAAAA to VVVVVVVV [A:Current/V:Voltage] [Left](Ao4)(Ao3)(Ai5)(Ai4) (Ao2)(Ao1)(Ai2)(Ai1)[Right]
<b>dA-61</b> Analog input [Ai1] monitor	0.00 to 100.00(%)
<b>dA-62</b> Analog input [Ai2] monitor	
<b>dA-63</b> Analog input [Ai3] monitor	-100.00 to 100.00(%)
<b>dA-64</b> Analog input [Ai4] monitor	0.00 to 100.00(%)
<b>dA-65</b> Analog input [Ai5] monitor	0.00 to 100.00(%)
<b>dA-66</b> Analog input [Ai6] monitor	-100.00 to 100.00(%)
<b>dA-70</b> Pulse train input monitor (internal)	-100.00 to 100.00(%)
<b>dA-71</b> Pulse train input monitor (option)	-100.00 to 100.00(%)
<b>dA-81</b> Option slot-1 status	00:(none)/01:(P1-EN)/02:(P1-ECT)/03:(P1-PN)/05:(P1-DN)/06:(P1-PB) /07:(P1-CCL)/18:(P1-AG)33:(P1-FB)(only dA-82)48:(P1-FS)(only dA-83)
<b>dA-82</b> Option slot-2 status	
<b>dA-83</b> Option slot-3 status	

\*1) dA-17 is invalid when the Control mode selection (AA121/AA221) setting is 00 to 07 (V/f control mode).

\*2) (After calculation) means that it is after calculation such as auxiliary speed or addition frequency and calculation such as torque bias.



## [db-01] to [db-64]

Code/Name	Range (unit)
<b>db-01</b> Program download monitor	00(Program is not installed)/ 01(Program is installed)
<b>db-02</b> Program No. monitor	0000 to 9999
<b>db-03</b> Program counter (Task-1)	1 to 1024
<b>db-04</b> Program counter (Task-2)	
<b>db-05</b> Program counter (Task-3)	
<b>db-06</b> Program counter (Task-4)	
<b>db-07</b> Program counter (Task-5)	
<b>db-08</b> User monitor-0	-2147483647 to +2147483647
<b>db-10</b> User monitor-1	
<b>db-12</b> User monitor-2	
<b>db-14</b> User monitor-3	
<b>db-16</b> User monitor-4	
<b>db-18</b> Analog output monitor YA0	0.00 to 100.00%
<b>db-19</b> Analog output monitor YA1	
<b>db-20</b> Analog output monitor YA2	
<b>db-21</b> Analog output monitor YA3	
<b>db-22</b> Analog output monitor YA4	
<b>db-23</b> Analog output monitor YA5	

Code/Name	Range (unit)
<b>db-30</b> PID1 feedback value 1 monitor	-100.00 to 100.00(%) (Range will depend on the [AH-04] [AH-05] [AH-06])
<b>db-32</b> PID1 feedback value 2 monitor	
<b>db-34</b> PID1 feedback value 3 monitor	
<b>db-36</b> PID2 feedback value monitor	-100.00 to 100.00(%) (Range will depend on the [AJ-04][AJ-05][AJ-06])
<b>db-38</b> PID3 feedback value monitor	-100.00 to 100.00(%) (Range will depend on the [AJ-24] [AJ-25] [AJ-26])
<b>db-40</b> PID4 feedback value monitor	-100.00 to 100.00(%) (Range will depend on the [AJ-44] [AJ-45] [AJ-46])
<b>db-42</b> PID1 target value monitor (after calculation)	-100.00 to 100.00(%) (Range will depend on the [AH-04] [AH-05] [AH-06])
<b>db-44</b> PID1 feedback value monitor (after calculation)	
<b>db-50</b> PID1 output monitor	-100.00 to +100.00(%)
<b>db-51</b> PID1 deviation monitor	-200.00 to +200.00(%)
<b>db-52</b> PID1 deviation 1 monitor	
<b>db-53</b> PID1 deviation 2 monitor	
<b>db-54</b> PID1 deviation 3 monitor	
<b>db-55</b> PID2 output monitor	-100.00 to +100.00(%)
<b>db-56</b> PID2 deviation monitor	-200.00 to +200.00(%)
<b>db-57</b> PID3 output monitor	-100.00 to +100.00(%)
<b>db-58</b> PID3 deviation monitor	-200.00 to +200.00(%)
<b>db-59</b> PID4 output monitor	-100.00 to +100.00(%)
<b>db-60</b> PID4 deviation monitor	-200.00 to +200.00(%)
<b>db-61</b> Current PID P-Gain monitor	0.0 to 100.0
<b>db-62</b> Current PID I-Gain monitor	0.0 to 3600.0(s)
<b>db-63</b> Current PID D-Gain monitor	0.00 to 100.00(s)
<b>db-64</b> PID feedforward monitor	0.00 to 100.00(%)

## [dC-01] to [dE-50]

Code/Name	Range (unit)
<b>dC-01</b> Inverter load type status	00(Very Low duty)/ 01(Low duty)/ 02(Normal duty)
<b>dC-02</b> Rated current monitor	0.0 to 6553.5(A)
<b>dC-07</b> Main speed input source monitor	01 to 34 *1)
<b>dC-08</b> Sub speed input source monitor	00 to 06,08,25 to 33 *1)
<b>dC-10</b> RUN command input source monitor	00([FW]/[RV] terminal)/ 01(3-wire)/ 02(Keypad's RUN key) 03(RS485)/04(Option1)/ 05(Option2)/06(Option3)
<b>dC-15</b> Cooling fin temperature monitor	-20.0 to 200.0(°C)
<b>dC-16</b> Life assessment monitor	LL to HH [L:Normal/H:Worn out] [Left](FAN lifespan) [Right](board capacitor lifespan)
<b>dC-20</b> Accumulated number of starts monitor	1 to 65535(cycles)
<b>dC-21</b> Accumulated number of power-on times monitor	
<b>dC-22</b> Accumulated RUN time monitor	1 to 1000000(hr)
<b>dC-24</b> Accumulated power-on time monitor	
<b>dC-26</b> Accumulated cooling-fan run time monitor	
<b>dC-37</b> Icon 2 LIM monitor	00(Other than below )/ 01(OC suppress)/ 02(OL restriction)/ 03(OV suppress)/ 04(TRQ Limit)/ 05(Freq Limit)/06(Min. Freq)
<b>dC-38</b> Icon 2 ALT monitor	00(Other than below ) 01(OL notice ) 02(Motor thermal notice) 03(Controller thermal notice) 04(Motor overheating notice)
<b>dC-39</b> Icon 2 RETRY detail monitor	00(Other than below ) 01(Waiting for retry) 02(Waiting for restart)
<b>dC-40</b> Icon 2 NRDY detail monitor	00(Other than below ) (Output terminal 007[IRDY]= ON, When the state is other than the following ) 01(Trip occurrence) 02(Power supply error) 03(Resetting) 04(STO) / 05(Standby) 06(Data Warning, etc) 07(EzSQ Sequence error) 08(Free run) / 09(Forced stop)
<b>dC-45</b> IM/SM monitor	00 (IM selected)/ 01 (SM selected)
<b>dC-50</b> Firmware ver. Monitor	00.00 to 99.99
<b>dC-53</b> Firmware Gr. Monitor	00(Standard)
<b>dE-50</b> Warning monitor	0 to 65535 Refer to P1 users guide

\*1)00(disabled)/01(Ai1)/02(Ai2)/03 (Ai3)/04(Ai4)/05(Ai5)/06(Ai5)  
07(Multi-speed 0)/08(auxiliary speed)/09 to 23(Multi-speed1 to 15)/  
24(JG[AG-20])/25(RS485)/26(option-1)/27(option-2)/28(option-3)/  
29(Pulse train input(internal))/30(Pulse train input(option))/31(EzSQ)  
32(PID)/33(MOP-VR)/34(AHD retention speed)/

## [FA-01] to [FA-40]

## ■ Variable mode monitor (F code)

- If a parameter that is being monitored by one of the [FA] parameters can be modified, it can directly be modified through that [FA] parameter.

Code/Name	Range (unit)
<b>FA-01</b> Main speed reference setting or monitor	0.00 to 590.00(Hz)
<b>FA-02</b> Sub-speed reference setting or monitor	-590.00 to 590.000(Hz) (at monitor) 0.00 to 590.00(Hz) (at setting)
<b>FA-10</b> Acceleration time setting or monitor	0.00 to 3600.00(s)
<b>FA-12</b> Deceleration time setting or monitor	
<b>FA-15</b> Torque reference setting or monitor	-500.0 to 500.0(%)
<b>FA-16</b> Torque bias setting or monitor	-500.0 to 500.0(%)
<b>FA-20</b> Position reference setting or monitor	When [AA121]≠10 or [AA123]≠03 -268435455 to +268435455 (pls)  Other than above. -1073741823 to +1073741823 (pls)
<b>FA-30</b> PID1 set-point 1 setting or monitor	-100.00 to 100.00(%) (Range will depend on the [AH-04][AH-05][AH-06] )
<b>FA-32</b> PID1 set-point 2 setting or monitor	
<b>FA-34</b> PID1 set-point 3 setting or monitor	
<b>FA-36</b> PID2 set-point setting or monitor	-100.00 to 100.00(%) (Range will depend on the [AJ-04][AJ-05][AJ-06] )
<b>FA-38</b> PID3 set-point setting or monitor	-100.00 to 100.00(%) (Range will depend on the [AJ-24][AJ-25][AJ-26] )
<b>FA-40</b> PID4 set-point setting or monitor	-100.00 to 100.00(%) (Range will depend on the [AJ-44][AJ-45][AJ-46] )

4.4 Parameter naming (Nomenclature)

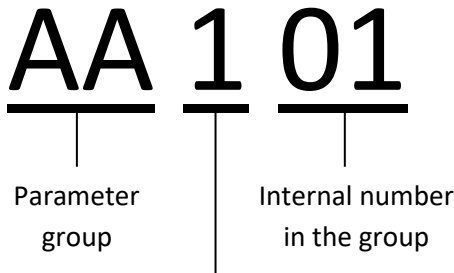

- : Common for 1<sup>st</sup> and 2<sup>nd</sup> motor
- 1 : 1<sup>st</sup> motor parameters are enabled if [SET] is OFF
- 2 : 2<sup>nd</sup> motor parameters are enabled if [SET] is ON

※By default, 1<sup>st</sup> motor parameters are enabled in the case that 08:[SET] is not assigned in the Intelligent Input terminals [CA-01] to [CA-11].

Input terminal 024[SET] enable code example.

[SET]OFF	[SET]ON
[**.**] type	[**.**] type
[**1**] type	[**2**] type

(Example)

[SET]OFF	[SET]ON
[AH-01]	[AH-01]
[Ub-01]	[Ub-01]
...	...
[Hb102]	[Hb202]
[Ab110]	[Ab210]
[bA122]	[bA222]
...	...

※In the following description, when using the 2nd motor parameters with the [SET] terminal function, replace the 1st motor parameters with the 2nd motor parameters.

4.5 Parameter arrangement

The order of explanation of parameters in this chapter is parameter group and group number as shown in the example below.

Example) Regarding the order of the parameter descriptions in this chapter.

- [AA101]⇒[AA102]⇒[AA104]⇒[AA105]⇒...
- ⇒[AA123]⇒[AA201]⇒...⇒[AA223]⇒
- [Ab-01]⇒[Ab-03]⇒[Ab110]⇒[Ab-11]⇒...
- (Parameters order depends on the last 2 digit.)
- ⇒[Ab-25]⇒[Ab210]⇒
- [AC-01]⇒...

(At first the 1<sup>st</sup> motor parameters which middle character is “.” or “1” are shown, next the 2<sup>nd</sup> motor parameters which middle character is “2” are shown, then the group number will change.)

※Depending on display restriction function, Parameters may not be displayed in order. Refer to [UA-10][UA-21][UA-22].

[AA101] to [AA106]

4.6 Parameter explanation



Working

- To set parameters, read and understand the P1 user’s guide first.
- For the motor protection, the following parameters are necessary to be set.
  - [Hb102] to [Hb108](If [IM])
  - [Hd102] to [Hd108](If [SM/PM])
  - [bC110](Electronic thermal level setting, 1st-motor)

※The initial value may vary according to a Model name. Model name: P1-(numeral)-(voltage)(keypad)(area)(filter) (Example) Japan 200V Class P1-00044-LFF

Europe 400V Class P1-00054-HF

Voltage rating: The voltage class is L(200V)/H(400V)

localize: None(JPN)/E(EU,ASIA)/U(USA)/C(CHN)

※When option is connected, parameters to display or setting range may be added. For more details, refer to respective option User’s Guide.

■ Parameter mode (A code)

Frequency reference selection

Code/Name	Range (unit)	Initial value
<b>AA101</b> Main speed input source selection, 1st-motor	01 to 16 *1)	07(JPN)/01(EU)(USA)(ASIA)(CHN)
<b>AA102</b> Sub speed input source selection, 1st-motor	00 to 16 *1)	00
<b>AA104</b> Sub speed setting, 1st-motor	0.00 to 590.00(Hz)	0.00
<b>AA105</b> Speed reference calculation symbol selection, 1st-motor	00(Disable)/01(Addition)/02(Subtraction)/03(Multiplication)	00

\*1)00(Disable)/01(Terminal[Ai1])/02(Terminal[Ai2])/03(Terminal[Ai3])/04(Terminal[Ai4])/05(Terminal[Ai5])/06(Terminal[Ai6])/07(Parameter Setting)/08(RS485)/09(Option-1)/10(Option-2)/11(Option-3)/12(Pulse train input(internal))/13(Pulse train input(option))/14(Program function)/15(PID)/16(MOP VR)

- To change the frequency reference input source, use [AA101]. Example: to set by [FA-01] -> [AA101]=07  
To set by Analog(voltage) to set -> [AA101]=01(Ai1)
- For the Sub speed, "main/sub speed switching" and "calculation with main speed" are possible.
- If [AA105]=00, the Intelligent input terminal 015[SchG] can change the frequency reference input source between the main speed (OFF) and sub speed (ON) .
- With the selected operator of [AA105], the main speed and sub speed can be calculated and used as frequency reference.

Temporary frequency addition

Code/Name	Range (unit)	Initial value
<b>AA106</b> Add frequency setting, 1st-motor	-590.00 to +590.00(Hz)	0.00

- When the input terminal 014[ADD] is ON the frequency set in [AA106] will be temporarily added to the frequency reference.

## [AA111] to [AA115][bb-40]

## RUN command selection

Code/Name	Range (unit)	Initial value
<b>AA111</b> RUN command input source selection, 1st- motor	00([FW]/[RV] terminal) 01(3-wire)	02(JPN)/
	02(Keypad's RUN-key)	00(EU)
	03(RS485)	(USA)
	04(Option-1)	(ASIA)
	05(Option-2)	(CHN)
	06(Option-3)	

- Select in which way will be operated.  
In case it does not work, please review it.

## Keypad keys setting

Code/Name	Range (unit)	Initial value
<b>AA-12</b> RUN-key command rotation direction	00(Forward)/ 01(Reverse)	00
<b>AA-13</b> STOP-key enable	00(Disable)/01(Enable)/ 02(Enable at only trip reset)	01

- [AA-12] specifies in which direction (forward/reverse) will be the rotation after pressing the RUN key in the operation keypad.
- [AA-13] changes the behavior of the STOP key of keypad. When 01 (enable) (initial value) is set, the STOP key performs stop operation regardless of the run command selection. When stopping only with the command selected in the run command selection, change it to 00(disabled). If the run command selectin [AA111] is set to 02(Keypad's RUN key), the STOP key on the Keypad is valid regardless of the [AA-13] setting.

## RUN command direction restriction

Code/Name	Range (unit)	Initial value
<b>AA114</b> RUN direction restriction,1st-motor	00(No restriction)/ 01(Only forward)/ 02(Only reverse)	00

- In the case of an incorrect RUN command, [AA114] setting prevents the output from unintended rotation.

## Restart operation after decel/free-run STOP

Code/Name	Range (unit)	Initial value
<b>AA115</b> STOP mode selection, 1st-motor	00(Deceleration stop)/ 01(Free-run stop)	00
<b>bb-40</b> Restart mode after FRS release	00(Restart at 0Hz)/ 01(Restart with matching frequency)/ 02(Restart with active frequency matching)/ 03(Detect speed) (*1)	00

(\*1) This function requires encoder feedback to the P1-FB option or to the input terminals [A]/[B] assigned the function 103[PLA]/104[PLB].

- In the [AA115], deceleration stop or free-run stop can be selected when a stop command is executed.
- If input terminal 032[FRS] is active (ON), free-run stop is possible.
- In the [bb-40], the restart method after the release of the 032[FRS] and the restart method after the free-run at the stop are selected.
- If the overvoltage error [E007] occurs during deceleration, if the motor is allowed to stop coasting, the [E007] will be avoided by free-run stop by setting the [AA115] to 01 (Free-run stop).

## [AA121] to [AA223]

## Control mode selection

Code/Name	Range (unit)	Initial value
<b>AA121</b> Control mode selection, 1st-motor	00 ([V/f] Fixed torque characteristics (IM))/ 01 ([V/f] Reducing torque characteristics (IM))/ 02 ([V/f] Free V/f (IM))/ 03 ([V/f] Auto torque boost (IM))/ 04 ([V/f with encoder] Fixed torque characteristics (IM))/ 05 ([V/f with encoder] Reduced torque characteristics (IM))/ 06 ([V/f with encoder] Free V/f (IM))/ 07 ([V/f with encoder] Auto torque boost (IM))/ 08 (Sensorless vector control (SLV) (IM))/ 09 (0Hz-range sensorless vector control (0Hz-SLV) (IM)) / 10 (Vector control with encoder (CLV)(IM)) / 11(Synchronous start type sensorless vector control(SM/PMM))/ 12 (IVMS start type sensorless vector control (SM/PMM))	00

- Generally for a light duty control (such as fans or pumps) , the [V/f] control with fixed torque characteristics or the [V/f] control with reducing torque characteristics similar to the operation characteristics of fans and pumps is selected.
- For heavy load (Cranes, etc...), sensorless vector control(SLV) is the typically used. If heavy torque is required at startup, closed loop vector control(CLV) or 0Hz-range sensorless vector control(0Hz-SLV) will be used.
- For a magnet motor, select the sensorless vector control (SM/PMM).
- ※ With the Load Type(Ub-03) is in standard duty (ND) all the setting items are available. But the Load type is in Low duty (LD), 09 and 10 is not available. And at the Load type in very low duty (VLD), 09, 10 and 12 is not available.

## Vector control with encoder mode

Code/Name	Range (unit)	Initial value
<b>AA123</b> Vector control mode selection, 1st-motor	00(Speed/Torque control mode)/ 01(Pulse train position control)/ 02(Position control)/ 03(High-resolution position control)	00

- Torque control is effective only when the AA121 setting is 08 to 12 and the AA123 setting is 00.
- Pulse train position control is effective only when the AA121 setting is 10 and the AA123 setting is 01, And input terminal 073[STAT] is assigned and must be ON.
- Absolute position control is effective only when the AA121 setting is 10 and the AA123 setting is 02 or 03.
- For more information, refer to the P1 user's guide.

**2nd motor** When Intelligent Input terminal 024[SET] is enabled.

Code/Name	Range (unit)	Initial value
<b>AA201</b> Main speed input source selection, nd-motor		Same as AA101
<b>AA202</b> Sub speed input source selection, 2nd-motor		Same as AA102
<b>AA204</b> Sub speed setting, 2nd-motor		Same as AA104
<b>AA205</b> Speed reference calculation symbol selection, 2nd-motor		Same as AA105
<b>AA206</b> Add frequency setting, 2nd-motor		Same as AA106
<b>AA211</b> RUN command input source selection, 2nd-motor		Same as AA111
<b>AA214</b> RUN-direction restriction selection, 2nd-motor		Same as AA114
<b>AA215</b> STOP mode selection, 2nd-motor		Same as AA115
<b>AA221</b> Control mode selection 2nd-motor		Same as AA121
<b>AA223</b> Vector control mode selection, 2nd-motor		Same as AA123

[Ab-01] to [Ab-25]

**Frequency scale conversion monitor [dA-06]**

Code/Name	Range (unit)	Initial value
<b>Ab-01</b> Frequency conversion gain	0.01 to 100.00	1.00

- The visualized “Output frequency scale conversion monitor[dA-06]” is equal to the “Output frequency monitor[dA-01]” multiplied by the “Frequency conversion gain[Ab-01]”.

**Multi-speed command**

Code/Name	Range (unit)	Initial value
<b>Ab-03</b> Multi-speed operation selection	00(Binary(16 speeds))/01(Bit(8 speeds))	00
<b>Ab110</b> Multi-speed 0 setting, 1st-motor	0.00 to 590.00(Hz) *1)	0.00
<b>Ab-11</b> Multi-speed 1 setting	0.00 to 590.00(Hz) *1)	0.00
<b>Ab-12</b> Multi-speed 2 setting	0.00 to 590.00(Hz) *1)	0.00
<b>Ab-13</b> Multi-speed 3 setting	0.00 to 590.00(Hz) *1)	0.00
<b>Ab-14</b> Multi-speed 4 setting	0.00 to 590.00(Hz) *1)	0.00
<b>Ab-15</b> Multi-speed 5 setting	0.00 to 590.00(Hz) *1)	0.00
<b>Ab-16</b> Multi-speed 6 setting	0.00 to 590.00(Hz) *1)	0.00
<b>Ab-17</b> Multi-speed 7 setting	0.00 to 590.00(Hz) *1)	0.00
<b>Ab-18</b> Multi-speed 8 setting	0.00 to 590.00(Hz) *1)	0.00
<b>Ab-19</b> Multi-speed 9 setting	0.00 to 590.00(Hz) *1)	0.00
<b>Ab-20</b> Multi-speed 10 setting	0.00 to 590.00(Hz) *1)	0.00
<b>Ab-21</b> Multi-speed 11 setting	0.00 to 590.00(Hz) *1)	0.00
<b>Ab-22</b> Multi-speed 12 setting	0.00 to 590.00(Hz) *1)	0.00
<b>Ab-23</b> Multi-speed 13 setting	0.00 to 590.00(Hz) *1)	0.00
<b>Ab-24</b> Multi-speed 14 setting	0.00 to 590.00(Hz) *1)	0.00
<b>Ab-25</b> Multi-speed 15 setting	0.00 to 590.00(Hz) *1)	0.00

\*1) The actual setting range is limited to the maximum frequency setting ([Hb105/205] [Hd105/205]).

- For the 16 speeds selection, set [Ab-03]=00 for assigning the intelligent terminals 003[CF1] to 006[CF4] makes available the use of the speeds 0 to 15.

Multi-speed	CF4	CF3	CF2	CF1
Speed 0	OFF	OFF	OFF	OFF
Speed 1	OFF	OFF	OFF	OFF
Speed 2	OFF	OFF	OFF	OFF
Speed 3	OFF	OFF	OFF	OFF
Speed 4	OFF	OFF	OFF	OFF
Speed 5	OFF	OFF	OFF	OFF
Speed 6	OFF	OFF	OFF	OFF
Speed 7	OFF	OFF	OFF	OFF
Speed 8	OFF	OFF	OFF	OFF
Speed 9	OFF	OFF	OFF	OFF
Speed 10	OFF	OFF	OFF	OFF
Speed 11	OFF	OFF	OFF	OFF
Speed 12	OFF	OFF	OFF	OFF
Speed 13	OFF	OFF	OFF	OFF
Speed 14	OFF	OFF	OFF	OFF
Speed 15	OFF	OFF	OFF	OFF

[Ab210][AC-01] to [AC-02]

- For the 8 speeds selection, set [Ab-03]=01 assigning the intelligent terminals 007[SF1] to 013[SF7] makes available the use of the speeds 0 to 7.

Multi-speed	SF7	SF6	SF5	SF4	SF3	SF2	SF1
Speed 0	OFF	OFF	OFF	OFF	OFF	OFF	OFF
Speed 1	-	-	-	-	-	-	OFF
Speed 2	-	-	-	-	-	OFF	OFF
Speed 3	-	-	-	-	OFF	OFF	OFF
Speed 4	-	-	-	OFF	OFF	OFF	OFF
Speed 5	-	-	OFF	OFF	OFF	OFF	OFF
Speed 6	-	OFF	OFF	OFF	OFF	OFF	OFF
Speed 7	OFF	OFF	OFF	OFF	OFF	OFF	OFF

**2nd motor** When Intelligent Input terminal 024[SET] is enabled.

Code/Name	Range (unit)	Initial value
<b>Ab210</b> Multi-speed 0 setting, 2nd-motor	Same as Ab110	

**Input method for Accel/Decel time**

Code/Name	Range (unit)	Initial value
<b>AC-01</b> Acceleration/Deceleration time input source selection	00(Parameter setting)/01(Option-1)/02(Option-2)/03(Option-3)/04(Function EzSQ)	00

- [AC-01] changes the reference source for the Accel/Decel time command.

**Individual Accel/Decel time for Multispeed**

Code/Name	Range (unit)	Initial value
<b>AC-02</b> Acceleration/Deceleration selection	00(Common setting)/01(Multi stage accel/decel)	00

- When [AC-02]=00, the Accel/Decel time settings [AC120][AC122] or [AC124][AC126] are enable.
- 2-stage Accel/Decel time function is set with parameters [AC115] to [AC117].
- When [AC-02]=01, the Accel/Decel time [AC-30] to [AC-88] for each multispeed control (from speed 1 to 15) are enabled.
- Even if [AC-02]=01, while in Multspeed-0 command, Accel/Decel time setting [AC120] [AC122] or Accel/Decel time setting [AC124] [AC126] are enabled.
- [CA-64]/[CA-66] takes precedence during the input terminal 020[FUP]/021[FDN] function. And [AH-78] takes precedence during the PID soft start function.

[AC-03] to [AC117]

Acceleration/deceleration curve selection

Code/Name	Range (unit)	Initial value
<b>AC-03</b> Acceleration curve selection	00(Linear)/ 01(S-curve)/ 02(U-curve)/	00
<b>AC-04</b> Deceleration curve selection	03(Reverse U-curve)/ 04(Elevator S-curve)	00
<b>AC-05</b> Acceleration curve constant setting	1 to 10	2
<b>AC-06</b> Deceleration curve constant setting		2
<b>AC-08</b> EL-S-curve ratio @start of acceleration	0 to 100(%) *1)	25
<b>AC-09</b> EL-S-curve ratio @end of acceleration		25
<b>AC-10</b> EL-S-curve ratio @start of deceleration		25
<b>AC-11</b> EL-S-curve ratio @end of deceleration		25

\*1) The setting range is limited so that  $AC-08+AC-09 \leq 100$  (%).  
For example, when  $AC-09=25\%$ , the setting range of  $AC-08$  is 0 to 75%.  
 $AC-10$  and  $AC-11$  are the same as above.

- When [AC-03]/[AC-04] = 00 (Linear), the Accel/Decel time operation becomes linear toward the target value.
- When [AC-03]/[AC-04] = 01 (S-curve), the start and end of the Accel/Decel time operation is made loose and shockless operation is performed.
- When [AC-03]/[AC-04] = 02 (U-curve), at the start of the Accel/Decel time operation is made loose.
- When [AC-03]/[AC-04]=03(Reverse -U-curve), at the end of the Accel/Decel time operation is made loose.
- For S-curve, U-curve and Reverse U-curve, the curve degree of Accel/Decel time operation can be set with [AC-05]/[AC-06].
- When [AC-03]/[AC-04] = 04 (EL-S-curve), at the start and end of the Accel/Decel time operation is made loose.
- For EL-S-curve shockless operation, the curve degree of Accel/Decel time operation can be adjusted with [AC-08] to [AC-11].

2-stage Accel/Decel time change

Code/Name	Range (unit)	Initial value
<b>AC115</b> Accel/Decel change trigger, 1st-motor	00(Switching by [2CH] terminal)/ 01(Switching by setting)/ 02(Switching only when rotation is reversed)	00
<b>AC116</b> Accel1 to Accel2 frequency transition point, 1st-motor	0.00 to 590.00(Hz)	0.00
<b>AC117</b> Decel1 to Decel2 frequency transition point, 1st-motor		0.00

- Depending on the setting of [AC115], the trigger for switching to Accel/Decel time 2 is selected from the following.  
"When the input terminal 031 [2CH] is turned ON",  
"When the operating frequency reaches the set frequency [AC116]/[AC117]",  
"When the operating frequency switches from forward to reverse".
- Set the Accel/Decel time1 with [AC120] and [AC122], and the Accel/Decel time2 with [AC124] and [AC126].

[AC120] to [AC126]

Acceleration/deceleration time setting

Code/Name	Range (unit)	Initial value
<b>AC120</b> Acceleration time setting 1, 1st-motor	0.00 to 3600.00(s)	30.00
<b>AC122</b> Deceleration time setting 1, 1st-motor		30.00
<b>AC124</b> Acceleration time setting 2, 1st-motor		15.00
<b>AC126</b> Deceleration time setting 2, 1st-motor		15.00

- The Accel/Decel time setting is the time when operating from 0 Hz to the maximum frequency as shown below figure.
- In case that the 2-stage Accel/Decel time function is not used, the Accel/Decel time 1 [AC120]/[AC122] are used.

Ex ) The Accel/Decel time setting is from 0 Hz to the maximum frequency setting ( [Hb105]/[Hd105] ).  
In the case of maximum frequency = 60Hz,  
Accel time = 30sec, frequency reference=30Hz,  
The time to reach 30Hz is 15 seconds.  
( Under conditions when Accel/Decel time does not pause or etc for other functions.)

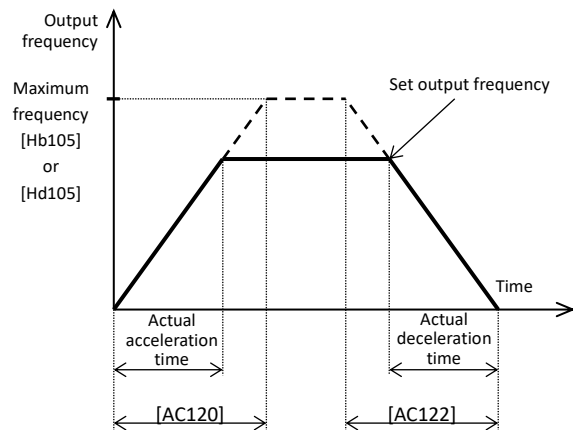

- Example of using the 2-stage Accel/Decel time function is following.  
With [AC115] = 00 (Switching by [2CH] terminal)

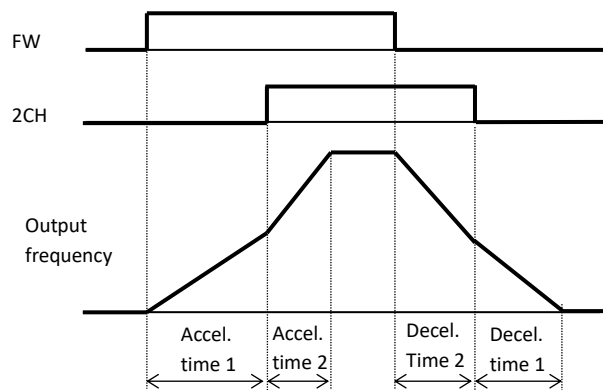

[AC-30] to [AC-88]

Individual Accel/Decel time for Multispeed

Code/Name	Range (unit)	Initial value
<b>AC-30</b> Accel. time for Multi-speed 1	0.00 to 3600.00(s)	0.00
<b>AC-32</b> Decel. time for Multi-speed 1		0.00
<b>AC-34</b> Accel. time for Multi-speed 2		0.00
<b>AC-36</b> Decel. time for Multi-speed 2		0.00
<b>AC-38</b> Accel. time for Multi-speed 3		0.00
<b>AC-40</b> Decel. time for Multi-speed 3		0.00
<b>AC-42</b> Accel. time for Multi-speed 4		0.00
<b>AC-44</b> Decel. time for Multi-speed 4		0.00
<b>AC-46</b> Accel. time for Multi-speed 5		0.00
<b>AC-48</b> Decel. time for Multi-speed 5		0.00
<b>AC-50</b> Accel. time for Multi-speed 6		0.00
<b>AC-52</b> Decel. time for Multi-speed 6		0.00
<b>AC-54</b> Accel. time for Multi-speed 7		0.00
<b>AC-56</b> Decel. time for Multi-speed 7		0.00
<b>AC-58</b> Accel. time for Multi-speed 8		0.00
<b>AC-60</b> Decel. time for Multi-speed 8		0.00
<b>AC-62</b> Accel. time for Multi-speed 9		0.00
<b>AC-64</b> Decel. time for Multi-speed 9		0.00
<b>AC-66</b> Accel. time for Multi-speed 10		0.00
<b>AC-68</b> Decel. time for Multi-speed 10		0.00
<b>AC-70</b> Accel. time for Multi-speed 11		0.00
<b>AC-72</b> Decel. time for Multi-speed 11		0.00
<b>AC-74</b> Accel. time for Multi-speed 12		0.00
<b>AC-76</b> Decel. time for Multi-speed 12		0.00
<b>AC-78</b> Accel. time for Multi-speed 13		0.00
<b>AC-80</b> Decel. time for Multi-speed 13		0.00
<b>AC-82</b> Accel. time for Multi-speed 14		0.00
<b>AC-84</b> Decel. time for Multi-speed 14		0.00
<b>AC-86</b> Accel. time for Multi-speed 15	0.00	
<b>AC-88</b> Decel. time for Multi-speed 15	0.00	

- Individual Accel/Decel times can be set for multispeed functions[Ab-11] to [Ab-25].

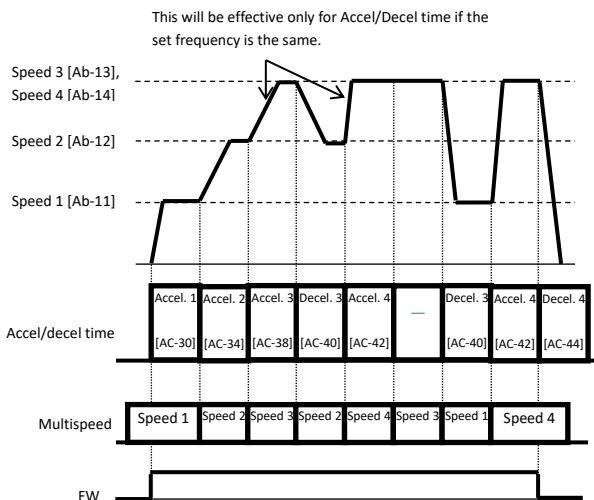

[AC215] to [AC226],[Ad-01] to [Ad-42]

2nd motor When Intelligent Input terminal 024[SET] is enabled.

Code/Name	Range (unit)	Initial value
<b>AC215</b> Accel/Decel change trigger, 2nd-motor	Same as AC115	
<b>AC216</b> Accel1 to Accel2 frequency transition point, 2nd-motor	Same as AC116	
<b>AC217</b> Decel1 to Decel2 frequency transition point, 2nd-motor	Same as AC117	
<b>AC220</b> Acceleration time 1, 2nd-motor	Same as AC120	
<b>AC222</b> Deceleration time 1, 2nd-motor	Same as AC122	
<b>AC224</b> Acceleration time 2, 2nd-motor	Same as AC124	
<b>AC226</b> Deceleration time 2, 2nd-motor	Same as AC126	

Torque control function setting

Code/Name	Range (unit)	Initial value
<b>Ad-01</b> Torque reference input source selection	01 to 13/15 *1)	07
<b>Ad-02</b> Torque reference value setting	-500.0 to 500.0(%)	0.0
<b>Ad-03</b> Polarity selection for torque reference	00(According to sign)/01(Depending on the operation direction)	00
<b>Ad-04</b> Switching time of speed control to torque control	0 to 1000(ms)	100

- The above parameters set the torque control operation.
- Torque control is enabled when input terminal 067[ATR] torque control enabled is turned ON and control mode [AA121] setting is set to 08 to 12 (sensorless vector control or vector control with sensor). For more information, refer to the P1 User's guide.

Torque bias setting

Code/Name	Range (unit)	Initial value
<b>Ad-11</b> Torque bias input source selection	01 to 13 /15 *1)	00
<b>Ad-12</b> Torque bias value setting	-500.0 to 500.0(%)	0.0
<b>Ad-13</b> Torque bias polarity	00(According to sign)/01(Depend on the operation direction)	00
<b>Ad-14</b> Enable terminal [TBS]	00(Disable)/01(Enable)	00

- For setting the torque bias. For more information, refer to the P1 User's guide.

Speed limitation for torque control

Code/Name	Range (unit)	Initial value
<b>Ad-40</b> Speed limit input source selection at torque control	01 to 13 *1)	07
<b>Ad-41</b> Speed limit at torque control (at Forward rotation)	0.00 to 590.00(Hz) *2)	0.00
<b>Ad-42</b> Speed limit at torque control (at Reverse rotation)		0.00

- The speed limit during the torque control can be set. For more information, refer to the P1 User's guide.
- \*1)00(Disable)/01(Terminal[Ai1])/02(Terminal[Ai2])/03(Terminal[Ai3])/04(Terminal[Ai4])/05(Terminal[Ai5])/06(Terminal[Ai6])/07(Parameter Setting)/08(RS485)/09(Option-1)/10(Option-2)/11(Option-3)/12(Pulse train input(internal))/13(Pulse train input(option))/15(PID calc.)
- \*2) The actual setting range is limited to the maximum frequency setting ([Hb105/205] [Hd105/205]).

## [AE-01] to [AE-13]

## Position control

Code/Name	Range (unit)	Initial value
<b>AE-01</b> Electronic gear setting point selection	00(Feedback side)/01(Reference side)	00
<b>AE-02</b> Electronic gear ratio numerator	1 to 10000	1
<b>AE-03</b> Electronic gear ratio denominator	1 to 10000	1
<b>AE-04</b> Positioning completed range setting	0 to 10000(pls)	5
<b>AE-05</b> Positioning completed delay time setting	0.00 to 10.00(s)	0.00
<b>AE-06</b> Position feedforward gain setting	0 to 655.35	0.00
<b>AE-07</b> Position loop gain setting	0.00 to 100.00	0.50
<b>AE-08</b> Position bias setting	-2048 to 2048(pls)	0

- Position control requires encoder feedback to the P1-FB option or to the input terminals [A]/[B] assigned 103[PLA]/104[PLB].
- See also input terminal 073[STAT],074[PUP],075[PDN] and output terminal 042[PDD], 043[POK] for position control.  
For more information, refer to the P1 User's guide.

## Home search function setting

Code/Name	Range (unit)	Initial value
<b>AE-10</b> Stop position selection of home search function	00(Parameter)/01(Option 1)/02(Option 2)/03(Option 3)/	00
<b>AE-11</b> Stop position of home search function	0 to 4095	0
<b>AE-12</b> Speed reference of home search function	0.00 to 120.00(Hz) *1)	0.00
<b>AE-13</b> Direction of home search function	00(Forward)/01(Reverse)	00

- \*1) If the maximum frequency setting ([Hb105/205] [Hd105/205]) is less than 120 Hz, the maximum value of [AE-12] will be limited to it.
- Adjust the Home search function of the position control. This function is valid only when AA121=10 and AA123=00, 01. And also assign the input terminal 069[ORT] Home search function and 109[PLZ] Pulse train input Z. For more information, refer to the P1 User's guide.

## [AE-20] to [AE-61]

## Absolute position control

Code/Name	Range (unit)	Initial value
<b>AE-20</b> Position reference 0	When [AA121]≠10 or [AA121]≠03 -268435455 to +268435455 (pls)  Parameter setting other than above. -1073741823 to +1073741823 (pls)	0
<b>AE-22</b> Position reference 1		0
<b>AE-24</b> Position reference 2		0
<b>AE-26</b> Position reference 3		0
<b>AE-28</b> Position reference 4		0
<b>AE-30</b> Position reference 5		0
<b>AE-32</b> Position reference 6		0
<b>AE-34</b> Position reference 7		0
<b>AE-36</b> Position reference 8		0
<b>AE-38</b> Position reference 9		0
<b>AE-40</b> Position reference 10		0
<b>AE-42</b> Position reference 11		0
<b>AE-44</b> Position reference 12		0
<b>AE-46</b> Position reference 13		0
<b>AE-48</b> Position reference 14		0
<b>AE-50</b> Position reference 15	0	
<b>AE-52</b> Position control range setting (forward)	When [AA121]≠10 or [AA123]≠03 0 to +268435455(pls)  Other than above. 0 to +1073741823(pls)	268435455
<b>AE-54</b> Position control range setting (reverse)	When [AA121]≠10 or [AA123]≠03 -268435455 to 0 (pls)  Other than above. -1073741823 to 0 (pls)	-268435455
<b>AE-56</b> Position control mode selection	00(Limited)/01(Not limited)	00

- The above parameters set the absolute position function.
- Absolute position reference 0 to 15 can be switched by the combination of input terminals 076[CP1] multistage position 1 to 079[CP4] multistage position 4. See also position control functions such as input terminal 082[FOT] Forward over travel, 083[ROT] Reverse over travel, 084[SPD] speed/position switching, 085[PSET] position data presetting and etc. For more information, refer to the P1 User's guide.

## Teach-in function

Code/Name	Range (unit)	Initial value
<b>AE-60</b> Teach-in function target selection	00 to 15(X00 to X15)	00

- Sets the teaching position for absolute position control.
- Use the input terminal 110[TCH] for teach-in function. For more information, refer to the P1 User's guide.

## Enable position saving when power is cut off

Code/Name	Range (unit)	Initial value
<b>AE-61</b> Save current position at power off	00(Disable)/01(Enable)	00

- When the [AE-61] is set to 01, the absolute position is automatically saved in the inverter's non-volatile memory when the power supply is turned off. For more information, refer to the P1 User's guide.



[AE-62] to [AE-73]

Pre-set position

Code/Name	Range (unit)	Initial value
<b>AE-62</b> Pre-set position data	When [AA121]≠10 or [AA121]≠03 -268435455 to +268435455(pls) Other than above. -1073741823 to +107374182(pls)	0

- During absolute position control, turning on the input terminal 085[PSET] sets the current position to the value set in [AE-62] pre-set position data. The current position monitor [dA-20] is also changed. For more information, refer to the P1 User's guide.

Positioning operation adjustment

Code/Name	Range (unit)	Initial value
<b>AE-64</b> Deceleration stop distance calculation gain	50.00 to 200.00(%)	100.00
<b>AE-65</b> Deceleration stop distance calculation bias	0.00 to 655.35(%)	0.00
<b>AE-66</b> Speed limit in APR control	0.00 to 100.00(%)	1.00
<b>AE-67</b> APR start speed	0.00 to 100.00(%)	0.20

\*APR: Automatic Position Regulator

- Adjustment of control operation for positioning operation. For more information, refer to the P1 user's guide.

Homing (Return to reference position)

Code/Name	Range (unit)	Initial value
<b>AE-70</b> Homing function selection	00(Low-speed)/ 01(High-Speed 1)/ 02(High-Speed 2)	00
<b>AE-71</b> Direction of homing function	00(Forward)/ 01(Reverse)	00
<b>AE-72</b> Low-speed homing speed setting	0.00 to 10.00(Hz)	0.00
<b>AE-73</b> High-speed homing speed setting	0.00 to 590.00(Hz) *1)	0.00

\*1) The actual setting range is limited to the maximum frequency setting ([Hb105/205] [Hd105/205]).

- Set the Homing function for absolute position mode.
- When using the homing function, assign the input terminal 080[ORL] Limit signal of homing function and 081[ORG] Start signal of homing function. For more information, refer to the P1 user's guide.

[AF101] to [AF109]

DC braking (DB) function

Code/Name	Range (unit)	Initial value
<b>AF101</b> DC braking selection, 1st-motor	00(Disable)/01(Enable)/ 02(Frequency reference)	00
<b>AF102</b> Braking type selection, 1st-motor	00(DC braking)/ 01(Speed servo-lock)/ 02(Position servo-lock)	00
<b>AF103</b> DC braking frequency, 1st-motor	0.00 to 590.00(Hz)	0.50
<b>AF104</b> DC braking delay time, 1st-motor	0.00 to 5.00(s)	0.00
<b>AF105</b> DC braking force setting, 1st-motor *2)	0 to 100(%)	30
<b>AF106</b> DC braking active time at stop, 1st-motor	0.00 to 60.00(s)	0.00
<b>AF107</b> DC braking operation method selection, 1st-motor	00(Edge)/ 01(Level)	01
<b>AF108</b> DC braking force at start, 1st-motor *2)	0 to 100(%)	30
<b>AF109</b> DC braking active time at start, 1st-motor	0.00 to 60.00(s)	0.00

- DB function can be activated at start-up and stop state ([AF101]=01) or at setting frequency ([AF101]=02), selectively.

- DC braking can be also used if Intelligent input terminal 030[DB] is ON.

\*2) Depending on the setting of Load type selection [Ub-03] and inverter capacity, an internal limit is applied to DC braking force.

- Stop DB example (Braking force adjusted by [AF105])

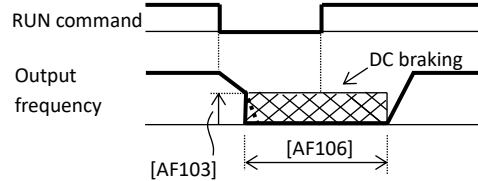

- Start DB example (Braking force adjusted by [AF108])

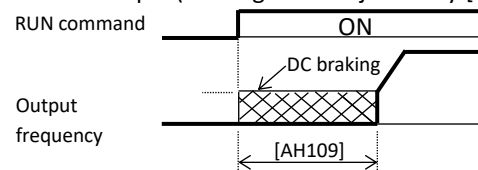

- Frequency reference DB example (Braking force adjusted by [AF105])

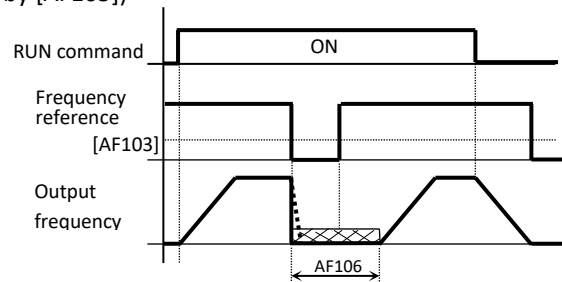

- When the DC braking time is set as 0.00(s), DC braking is not operational.

## [AF120] to [AF152]

## Brake control function

Code/Name	Range (unit)	Initial value
<b>AF120</b> Contactor control enable, 1st-motor	00(Disable)/ 01(Enable: primary side) 02(Enable: secondary side)	00
<b>AF121</b> Run delay time, 1st-motor	0.00 to 2.00(s)	0.20
<b>AF122</b> Contactor off delay time, 1st-motor	0.00 to 2.00(s)	0.10
<b>AF123</b> Contactor response check time, 1st-motor	0.00 to 5.00(s)	0.10
<b>AF130</b> Brake control enable, 1st-motor	00(Disable)/ 01(Brake control 1: Common)/ 02(Brake control 1: Separate)/ 03(Brake control 2)	00
<b>AF131</b> Brake release wait time, 1st-motor(Forward)	0.00 to 5.00(s)	0.00
<b>AF132</b> Brake wait time for accel., 1st-motor(Forward)	0.00 to 5.00(s)	0.00
<b>AF133</b> Brake wait time for stopping, 1st-motor (Forward)	0.00 to 5.00(s)	0.00
<b>AF134</b> Brake confirmation signal wait time, 1st-motor (Forward)	0.00 to 5.00(s)	0.00
<b>AF135</b> Brake release frequency setting, 1st-motor (Forward)	0.00 to 590.00(Hz)	0.00
<b>AF136</b> Brake release current setting, 1st-motor(Forward)	Inverter rated current ×(0.0 to 2.0)(A)	Inv rated current × 1.0(A)
<b>AF137</b> Braking frequency, 1st-motor (Forward)	0.00 to 590.00(Hz)	0.00
<b>AF138</b> Brake release wait time, 1st-motor (Reverse)	0.00 to 5.00(s)	0.00
<b>AF139</b> Brake wait time for accel., 1st-motor (Reverse)	0.00 to 5.00(s)	0.00
<b>AF140</b> Brake wait time for stopping, 1st-motor(Reverse)	0.00 to 5.00(s)	0.00
<b>AF141</b> Brake confirmation signal wait time, 1st-motor(Reverse)	0.00 to 5.00(s)	0.00
<b>AF142</b> Brake release frequency setting, 1st-motor (Reverse)	0.00 to 590.00(Hz)	0.00
<b>AF143</b> Brake release current setting, 1st-motor(Reverse)	Inverter rated current ×(0.0 to 2.0)(A)	Inv rated current × 1.0(A)
<b>AF144</b> Braking frequency, 1st-motor (Reverse)	0.00 to 590.00(Hz)	0.00
<b>AF150</b> Brake open delay time, 1st-motor	0.00 to 2.00(s)	0.20
<b>AF151</b> Brake close delay time, 1st-motor	0.00 to 2.00(s)	0.20
<b>AF152</b> Brake response check time, 1st-motor	0.00 to 5.00(s)	0.10

## [AF153] to [AF254]

Code/Name	Range (unit)	Initial value
<b>AF153</b> Servo lock/ DC injection time at start, 1st-motor	0.00 to 10.00(s)	0.60
<b>AF154</b> Servo lock/ DC injection time at stop, 1st-motor	0.00 to 10.00(s)	0.60

- The parameters [AF120] to [AF153] set the brake control and the contactor control.

In addition to these parameters, the brake control function uses the input terminal 037[BOK] Answer back from Brake and the output terminal 037[BRK] Brake release, 038[BER] Brake error. And the contactor control function uses the input terminal 107[COK] Contactor check signal and the output terminal 039[CON] Contactor control.

For more information, refer to the P1 User's guide.

## 2nd motor When Intelligent Input terminal 024[SET] is enabled.

Code/Name	Range (unit)	Initial value
<b>AF201</b> DC braking selection, 2nd-motor	Same as AF101	
<b>AF202</b> Braking type selection, 2nd-motor	Same as AF102	
<b>AF203</b> DC braking frequency, 2nd-motor	Same as AF103	
<b>AF204</b> DC braking delay time, 2nd-motor	Same as AF104	
<b>AF205</b> DC braking force setting, 2nd-motor	Same as AF105	
<b>AF206</b> DC braking active time at stop, 2nd-motor	Same as AF106	
<b>AF207</b> DC braking operation method selection, 2nd-motor	Same as AF107	
<b>AF208</b> DC braking force at start, 2nd-motor	Same as AF108	
<b>AF209</b> DC braking active time at start, 2nd-motor	Same as AF109	
<b>AF220</b> Contactor control enable, 2nd-motor	Same as AF120	
<b>AF221</b> Run delay time, 2nd-motor	Same as AF121	
<b>AF222</b> Contactor off delay time, 2nd-motor	Same as AF122	
<b>AF223</b> Contactor response check time, 2nd-motor	Same as AF123	
<b>AF230</b> Brake control enable, 2nd-motor	Same as AF130	
<b>AF231</b> Brake release wait time, 2nd-motor (Forward)	Same as AF131	
<b>AF232</b> Brake wait time for accel., 2nd-motor (Forward)	Same as AF132	
<b>AF233</b> Brake wait time for stopping, 2nd-motor (Forward)	Same as AF133	
<b>AF234</b> Brake confirmation signal wait time, 2nd-motor(Forward)	Same as AF134	
<b>AF235</b> Brake release frequency setting, 2nd-motor (Forward)	Same as AF135	
<b>AF236</b> Brake release current setting, 2nd-motor (Forward)	Same as AF136	
<b>AF237</b> Braking frequency, 2nd-motor (Forward)	Same as AF137	
<b>AF238</b> Brake release wait time, 2nd-motor (Reverse)	Same as AF138	
<b>AF239</b> Brake wait time for accel., 2nd-motor (Reverse)	Same as AF139	
<b>AF240</b> Brake wait time for stopping, 2nd-motor(Reverse)	Same as AF140	
<b>AF241</b> Brake confirmation signal wait time, 2nd-motor(Reverse)	Same as AF141	
<b>AF242</b> Brake release frequency setting, 2nd-motor(Reverse)	Same as AF142	
<b>AF243</b> Brake release current setting, 2nd-motor (Reverse)	Same as AF143	
<b>AF244</b> Braking frequency, 2nd-motor (Reverse side)	Same as AF144	
<b>AF250</b> Brake open delay time, 2nd-motor	Same as AF150	
<b>AF251</b> Brake close delay time, 2nd-motor	Same as AF151	
<b>AF252</b> Brake response check time, 2nd-motor	Same as AF152	
<b>AF253</b> Servo lock/DC injection time at start, 2nd-motor	Same as AF153	
<b>AF254</b> Servo lock/DC injection time at stop, 2nd-motor	Same as AF154	

[AG101] to [AG113]

**Resonant frequency avoidance (Jump)**

Code/Name	Range (unit)	Initial value
<b>AG101</b> Jump frequency 1, 1st-motor	0.00 to 590.00(Hz)	0.00
<b>AG102</b> Jump frequency width 1, 1st-motor	0.00 to 10.00(Hz)	0.00
<b>AG103</b> Jump frequency 2, 1st-motor	0.00 to 590.00(Hz)	0.00
<b>AG104</b> Jump frequency width 2, 1st-motor	0.00 to 10.00(Hz)	0.00
<b>AG105</b> Jump frequency 3, 1st-motor	0.00 to 590.00(Hz)	0.00
<b>AG106</b> Jump frequency width 3, 1st-motor	0.00 to 10.00(Hz)	0.00

- Using above parameters prevents from the passing of the output frequency in a resonant point. Output frequency changes discontinuously.

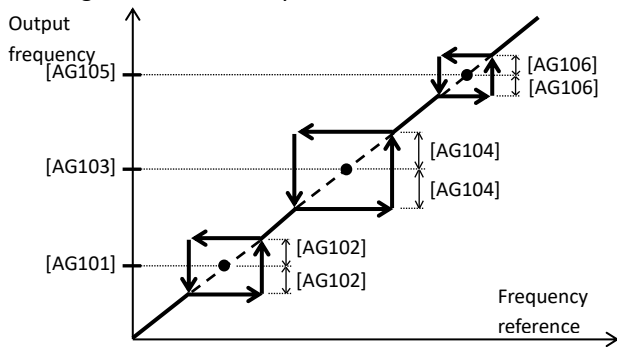

**Motor Accel/Decel time dwell (Hold)**

Code/Name	Range (unit)	Initial value
<b>AG110</b> Acceleration stop frequency setting, 1st-motor	0.00 to 590.00(Hz)	0.00
<b>AG111</b> Acceleration stop time setting, 1st-motor	0.0 to 60.0(s)	0.0
<b>AG112</b> Deceleration stop frequency setting, 1st-motor	0.00 to 590.00(Hz)	0.00
<b>AG113</b> Deceleration stop time setting, 1st-motor	0.0 to 60.0(s)	0.0

- When performing acceleration/deceleration operation with the large inertial load, acceleration/deceleration is temporarily stopped so that [E001] overcurrent error and [E007] overvoltage error do not occur.
- If the Intelligent input terminal 100[HLD] is in ON state, the acceleration and deceleration will be stopped (Hold activation).

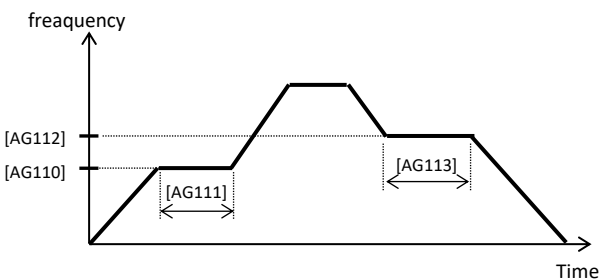

[AG-20] to [AG213]

**Jogging function**

Code/Name	Range (unit)	Initial value
<b>AG-20</b> Jogging frequency	0.00 to 10.00(Hz)	6.00
<b>AG-21</b> Jogging stop mode selection	00 (Free run at Jogging stop (Disable at run)) 01 (Deceleration stop at Jogging stop (Disable at run)) 02 (Dynamic brake at Jogging stop (Disable at run)) 03 (Free run at Jogging stop (Enable at run)) 04 (Deceleration stop at Jogging stop (Enable at run)) 05 (Dynamic brake at Jogging stop (Enable at run))	00

- The jogging frequency is outputted when Input terminal 029[JG] is active (ON) and the RUN command is given. The above parameters set the jogging frequency and stop method of jogging operation.

- In the case [AG-21]=01

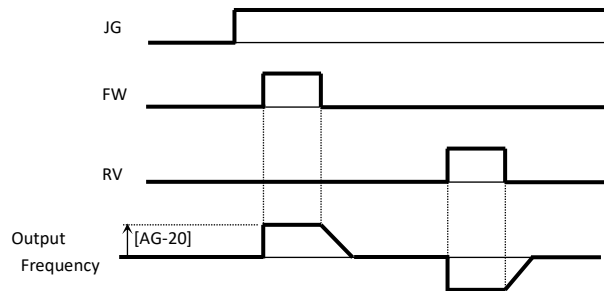

- 2nd motor** When Intelligent Input terminal 024[SET] is enabled.

Code/Name	Range (unit)	Initial value
<b>AG201</b> Jump frequency 1, 2nd-motor	Same as AG101	
<b>AG202</b> Jump frequency width 1, 2nd-motor	Same as AG102	
<b>AG203</b> Jump frequency 2, 2nd-motor	Same as AG103	
<b>AG204</b> Jump frequency width 2, 2nd-motor	Same as AG104	
<b>AG205</b> Jump frequency 3, 2nd-motor	Same as AG105	
<b>AG206</b> Jump frequency width 3, 2nd-motor	Same as AG106	
<b>AG210</b> Acceleration stop frequency setting, 2nd-motor	Same as AG110	
<b>AG211</b> Acceleration stop time setting 2nd-motor	Same as AG111	
<b>AG212</b> Deceleration stop frequency setting, 2nd-motor	Same as AG112	
<b>AG213</b> Deceleration stop time setting, 2nd-motor	Same as AG113	

[AH-01] to [AH-06]

**PID1 function**

Code/Name	Range (unit)	Initial value
<b>AH-01</b> PID1 enable	00(Disable)/ 01(Enable)/ 02(Enable (with inverted output))	00

- The PID1 function is enabled with the above parameter.
- If [AH-01]=01 when the PID output reaches negative value, the PID output is limited to 0.
- If [AH-01]=02 when the PID output reaches negative value, the PID output lets out an inverted output.
- When the PID output is negative, the motor will rotate in the contrary direction.
- If input terminal 041[PID] is ON, the PID control is disabled and the PID target value becomes the frequency reference.

Code/Name	Range (unit)	Initial value
<b>AH-02</b> PID1 deviation inversion	00(Disable)/ 01(Enable)	00

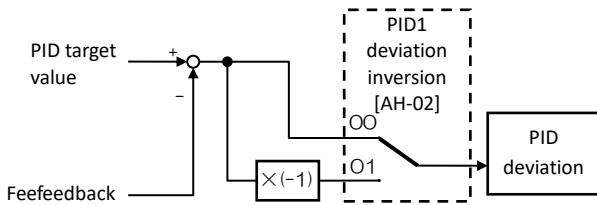

Code/Name	Range (unit)	Initial value
<b>AH-03</b> Unit selection for PID1	Refer <unit table> of the end of this chapter.	01
<b>AH-04</b> PID1 adjustment (0%)	-10000 to 10000	0
<b>AH-05</b> PID1 adjustment 100%	-10000 to 10000	10000
<b>AH-06</b> PID1 Adjustment (decimal point position)	0 to 4	2

- The unit and display data related to the output of the PID control can be changed.
- PID1 is capable of 3 target value inputs and 3 feedback inputs, and various operations can be performed with [AH-50] and [AH-54].

- When AH-50 = 01 to 04 (+, -, x, /), the operation target is PID1 set-point 1 (select from [AH-07] and [AH-10] to [AH-40]) and PID1 set-point 2 (selected with [AH-42]).

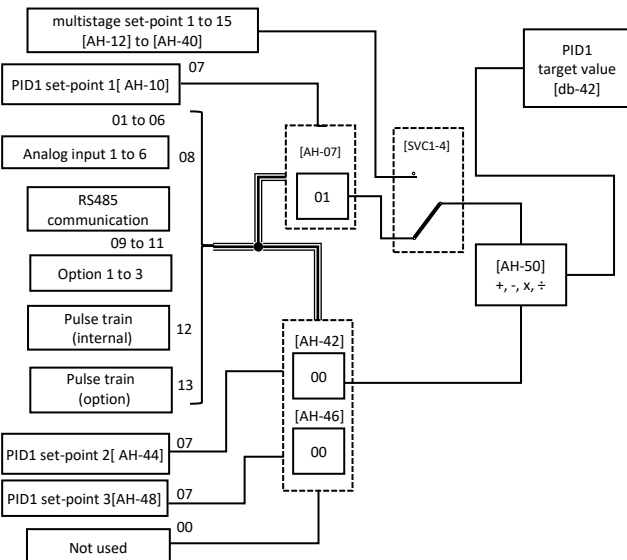

[AH-07] to [AH-50]

Code/Name	Range (unit)	Initial value
<b>AH-07</b> PID1 set-point 1 input source selection	00 to 13 *2)	09
<b>AH-10</b> PID1 set-point-1 setting		0.00
<b>AH-12</b> PID1 multistage set-point 1		0.00
<b>AH-14</b> PID1 multistage set-point 2		0.00
<b>AH-16</b> PID1 multistage set-point 3		0.00
<b>AH-18</b> PID1 multistage set-point 4		0.00
<b>AH-20</b> PID1 multistage set-point 5		0.00
<b>AH-22</b> PID1 multistage set-point 6		0.00
<b>AH-24</b> PID1 multistage set-point 7	-100.00 to 100.00(%) *1)	0.00
<b>AH-26</b> PID1 multistage set-point 8		0.00
<b>AH-28</b> PID1 multistage set-point 9		0.00
<b>AH-30</b> PID1 multistage set-point 10		0.00
<b>AH-32</b> PID1 multistage set-point 11		0.00
<b>AH-34</b> PID1 multistage set-point 12		0.00
<b>AH-36</b> PID1 multistage set-point 13		0.00
<b>AH-38</b> PID1 multistage set-point 14		0.00
<b>AH-40</b> PID1 multistage set-point 15	0.00	
<b>AH-42</b> PID1 set-point 2 input source selection	00 to 13 *2)	00
<b>AH-44</b> PID1 set-point 2 setting	-100.00 to 100.00(%) *1)	0.00
<b>AH-46</b> PID1 set-point 3 input source selection	00 to 13 *2)	0.00
<b>AH-48</b> PID1 set-point 3 setting	-100.00 to 100.00(%) *1)	0.00
<b>AH-50</b> PID1 set-point calculation symbol selection	01(Addition) 02(Subtraction) 03(Multiplication) 04(Division) 05(Minimum deviation) 06(Maximum deviation)	01

\*1) Range will depend on the parameters [AH-04], [AH-05] and [AH-06].  
 \*2) 00(Not used)/01(Terminal[Ai1])/02(Terminal[Ai2])/03(Terminal[Ai3])/04(Terminal[Ai4])/05(Terminal[Ai5])/06(Terminal[Ai6])/07(Parametersetting)/08(RS485)/09(Option-1)/10(Option-2)/11(Option-3)/12(Pulse train input (internal))/13(Pulse train input (option))

- If Input terminal 051[SVC1] to 054[SVC4] are used, the PID1 set-point 1 can be changed for the Multistage.

Multistage value	SVC4	SVC3	SVC2	SVC1
AH-10	OFF	OFF	OFF	OFF
AH-12	OFF	OFF	OFF	OFF
AH-14	OFF	OFF	OFF	OFF
AH-16	OFF	OFF	OFF	OFF
AH-18	OFF	OFF	OFF	OFF
AH-20	OFF	OFF	OFF	OFF
AH-22	OFF	OFF	OFF	OFF
AH-24	OFF	OFF	OFF	OFF
AH-26	OFF	OFF	OFF	OFF
AH-28	OFF	OFF	OFF	OFF
AH-30	OFF	OFF	OFF	OFF
AH-32	OFF	OFF	OFF	OFF
AH-34	OFF	OFF	OFF	OFF
AH-36	OFF	OFF	OFF	OFF
AH-38	OFF	OFF	OFF	OFF
AH-40	OFF	OFF	OFF	OFF

[AH-51] to [AH-54]

Code/Name	Range (unit)	Initial value
<b>AH-51</b> PID1 feedback 1 input source selection	00 to 06/08 to 13 *1)	01
<b>AH-52</b> PID1 feedback 2 input source selection		00
<b>AH-53</b> PID1 feedback 3 input source selection		00
<b>AH-54</b> PID1 feedback calculation symbol selection	01(Addition FB1+FB2)/ 02(Subtraction FB1-FB2)/ 03(Multiplication FB1×FB2)/ 04(Division FB1 / FB2)/ 05(Square Root FB1)/ 06(Square Root FB2)/ 07(Square Root(FB1-FB2))/ 08(Average of the three inputs) 09(Minimum of the three inputs) 10(Maximum of the three inputs)	01

\*1)00(Not used)/01(Terminal[Ai1])/02(Terminal[Ai2])/03(Terminal[Ai3])/04(Terminal[Ai4])/05(Terminal[Ai5])/06(Terminal[Ai6])  
08(RS485)/ 09(Option-1)/10(Option-2)/11(Option-3)/12(Pulse train input(internal))/13(Pulse train input(option))

■AH-50 = 05, 06 (minimum deviation, maximum deviation)  
The maximum value or the minimum value of deviation 1 to 3 of PID1 is taken as PID1 deviation (at this time, [AH-54] becomes invalid).

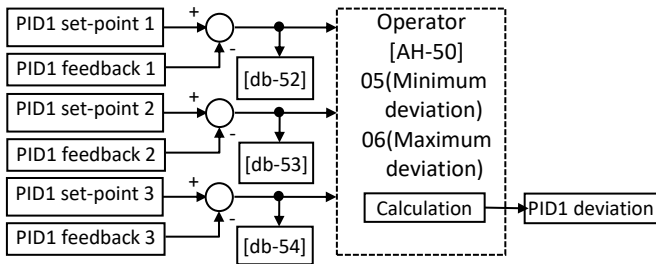

- PID1 feedback calculated by setting [AH-51] to [AH-54].
- When 01 to 07 is selected in [AH-54], the operation target is [AH-51] PID1 feedback data 1 (FB1) and [AH-52] PID1 feedback data 2 (FB2). When 08 to 10 is selected in [AH-54], feedback data 1 ([AH-51] selection (FB1)) to 3 ([AH-53] selection (FB3)) are targeted.

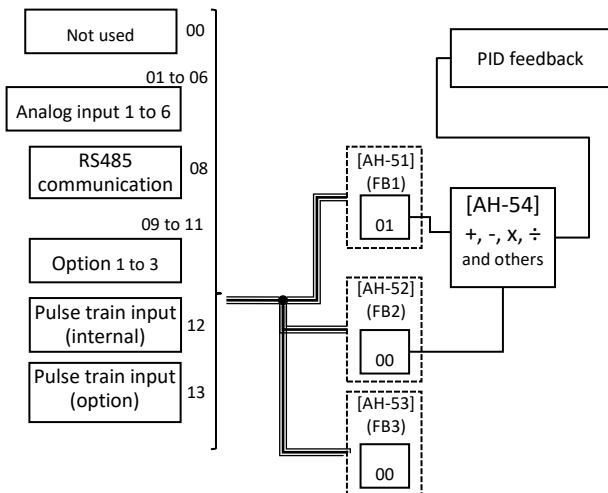

[AH-60] to [AH-70]

Code/Name	Range (unit)	Initial value
<b>AH-60</b> PID1 gain change method selection	00(Using gain-1 only)/ 01([PRO] terminal)	00
<b>AH-61</b> PID1 proportional gain 1	0.0 to 100.0	1.0
<b>AH-62</b> PID1 integral time constant 1	0.0 to 3600.0(s)	1.0
<b>AH-63</b> PID1 derivative gain 1	0.00 to 100.00(s)	0.00
<b>AH-64</b> PID1 proportional gain 2	0.0 to 100.0	0.0
<b>AH-65</b> PID1 integral time constant 2	0.0 to 3600.0(s)	0.0
<b>AH-66</b> PID1 derivative gain 2	0.00 to 100.00(s)	0.00
<b>AH-67</b> PID1 gain change time	0 to 10000(ms)	100

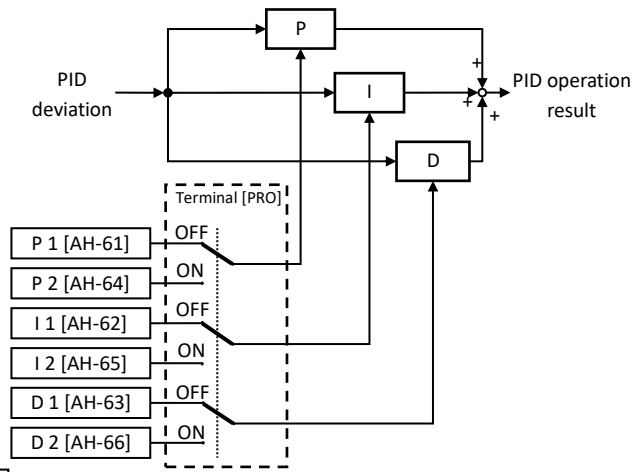

- If input terminal 042[PIDC] is active (ON), the value of the integral constant is cleared. If it is done while the inverter is in running, the driving condition may become unstable.
- The PID gain can be switched by turning on the input terminal 055[PRO]. When the [PRO] is ON, the gain 1 is effective, and when the [PRO] is OFF, the gain 2 is effective.

Code/Name	Range (unit)	Initial value
<b>AH-70</b> PID1 feedforward input source selection	00(Notused)/ 01(Terminal[Ai1])/ 02(Terminal[Ai2])/ 03(Terminal[Ai3])/ 04(Terminal[Ai4])/ 05(Terminal[Ai5])/ 06(Terminal[Ai6])	00

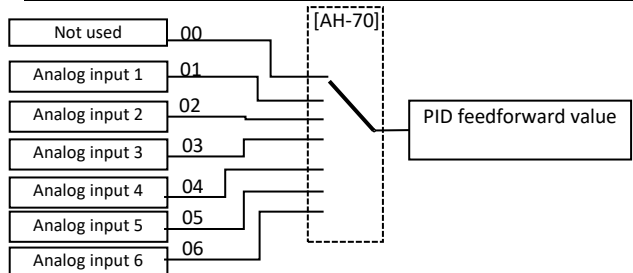

- The input source for PID feedforward control is selected by [AH-70].

[AH-71] to [AH-74]

Code/Name	Range (unit)	Initial value
<b>AH-71</b> PID1 output range	0.00 to 100.00(%)	0.00

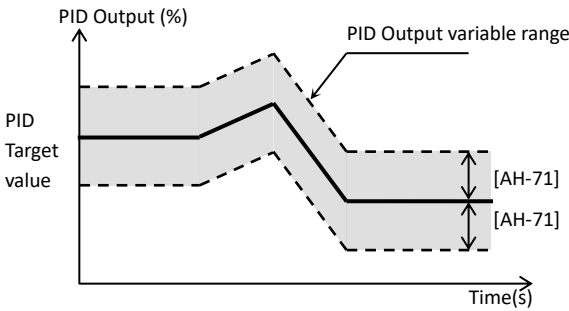

- [AH-71] Limits the output range of the PID. If [AH-71] = 0.00 the limit is disabled.

Code/Name	Range (unit)	Initial value
<b>AH-72</b> PID1 over deviation level	0.00 to 100.00(%)	3.00

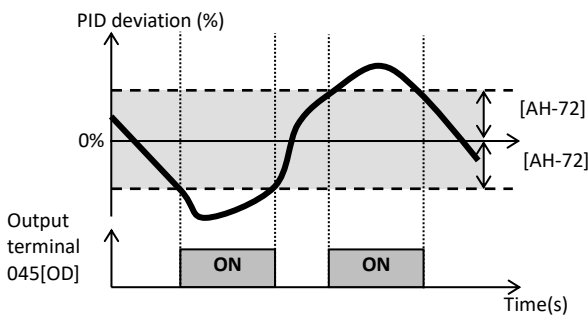

- When the PID deviation pass over the  $\pm$ [AH-72], the output terminal 045[OD] Deviation over for PID control is ON.

Code/Name	Range (unit)	Initial value
<b>AH-73</b> Turn-off level for the PID1 feedback compare signal	0.00 to 100.00(%)	100.00
<b>AH-74</b> Turn-on level for the PID1 feedback compare signal	0.00 to 100.00(%)	0.00

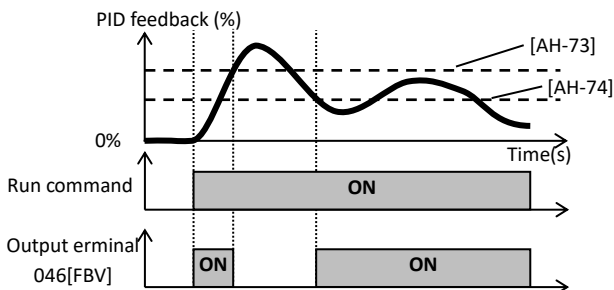

- When the PID feedback cross over the [AH-73] level, the output terminal 046[FBV] is OFF. If the PID feedback crosses under the [AH-74] level, 046[FBV] is turned ON.

[AH-75] to [AH-92]

PID soft start function

Code/Name	Range (unit)	Initial value
<b>AH-75</b> PID soft start function enable	00(Disable)/01(Enable)	00
<b>AH-76</b> PID soft start target level	0.00 to 100.00(%)	100.00
<b>AH-78</b> Acceleration time setting for PID soft start function	0.00 to 3600.00(s)	30.00
<b>AH-80</b> PID soft start time	0.00 to 600.00(s) *1)	0.00
<b>AH-81</b> PID soft start error detection enable	00(Disable)/01(Enable: Error[E120])/02(Enable:Warning[SSE])	00
<b>AH-82</b> PID soft start error detection level	0.00 to 100.00(%)	0.00

\*1) Ver2.01 and older, setting range is 0.00 to 100.0

- In order to start the shockless PID, normal operation is performed with the base frequency  $\times$  [AH-76] as the target frequency from the start of operation to the set time of [AH-80].
- The acceleration time at soft start can be set with [AH-78].

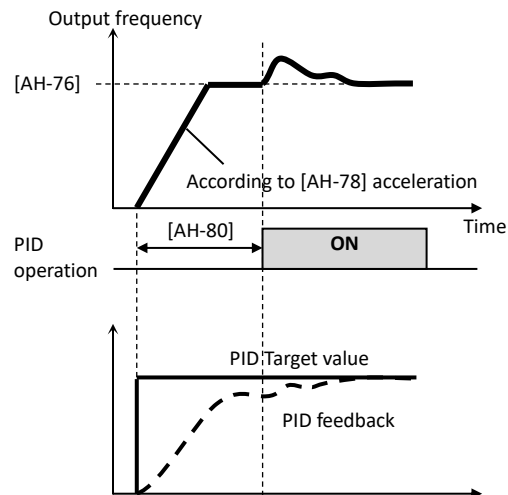

- When an error is judged, the operation changes depending on the setting of [AH-81] PID soft start error detection enable.
  - If [AH-81] is 00, nothing is done.
  - If [AH-81] is 01, the abnormal state will trip with [E120] PID start error after the set time of [AH-80] has elapsed.
  - If [AH-81] is 02, the output terminal 093[SSE] PID soft start error signal turns ON after the abnormal state has passed for the [AH-80] setting time.
  - Output terminal 093[SSE] signal is turned ON while the inverter is in running.

[AH-85] to [AH-96]

**PID sleep function**

Code/Name	Range (unit)	Initial value
<b>AH-85</b> PID sleep trigger selection	00(Disable)/ 01(Low output)/ 02([SLEP] terminal)	00
<b>AH-86</b> PID sleep start level	0.00 to 590.00(Hz)	0.00
<b>AH-87</b> PID sleep active time	0.00 to 100.00(s)	0.00
<b>AH-88</b> Enable set-point boost before PID sleep	00(Disable)/ 01(Enable)	00
<b>AH-89</b> Set-point boost time before PID sleep	0.00 to 100.00(s)	0.00
<b>AH-90</b> Set-point boost value before PID sleep	0.00 to 100.00(%)	0.00
<b>AH-91</b> Minimum RUN time before PID sleep	0.00 to 100.00(s)	0.00
<b>AH-92</b> Minimum active time of PID sleep	0.00 to 100.00(s)	0.00
<b>AH-93</b> PID wake trigger selection	01(Deviation)/ 02(Low feedback)/ 03([WAKE] terminal)	01
<b>AH-94</b> PID wake start level	0.00 to 100.00(%)	0.00
<b>AH-95</b> PID wake start time	0.00 to 100.00(s)	0.00
<b>AH-96</b> PID wake start deviation value	0.00 to 100.00(%)	0.00

- The PID sleep function temporarily reduces the PID output, achieving an energy saving state.
- If [AH-88]"Enable set-point boost before PID sleep" is enable, during [AH-89] setting time before PID sleep, the [AH-90] boost amount is added to the PID target value to increase the feedback amount. As a result, it is possible to maintain sleep for a longer time.

• Operation example of the sleep function.

Example 1) [AH-85]=01(Low output)  
[AH-93]=01(deviation)

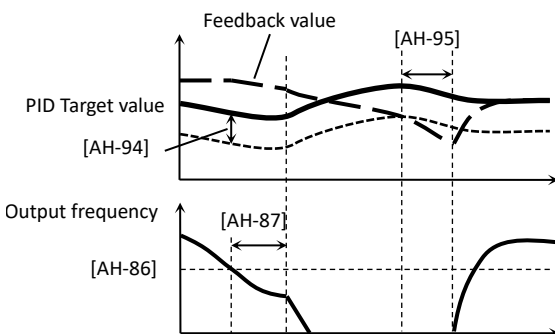

Example 2) [AH-85]=01(Low output)  
[AH-93]=02(Low feedback)

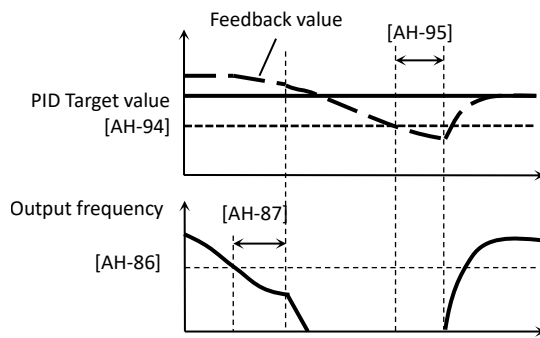

Example 3) [AH-85]=02(output terminal 058[SLEP])  
[AH-93]=03(output terminal 059[WAKE])

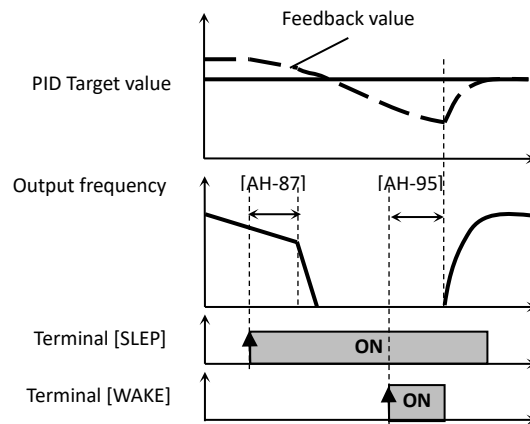

- There are 4 independent PID control blocks in P1. By switching the input terminal 056[PIO1]/057[PIO2], PID1 to PID4 can be switched.

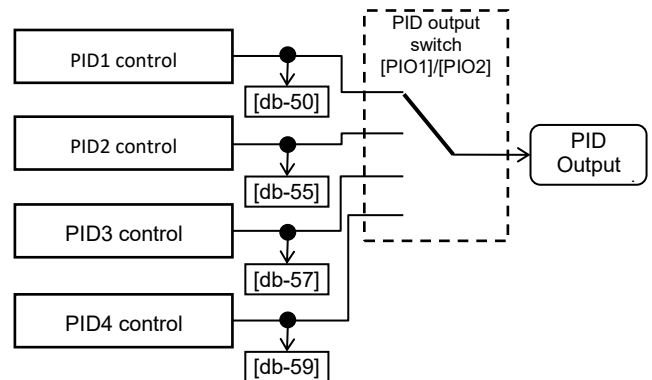

Combination of [PIO1]/[PIO2]

	057[PIO2]	056[PIO1]
PID1 is enabled	OFF	OFF
PID2 is enabled	OFF	ON
PID3 is enabled	ON	OFF
PID4 is enabled	ON	ON

[AJ-01] to [AJ-12]

[AJ-13] to [AJ-19]

**PID2 function**

Code/Name	Range (unit)	Initial value
<b>AJ-01</b> PID2 enable	00(Disable)/01(Enable)/02(Enable (with inverted output))	00

- The PID2 function is enabled with the above parameter.
- If [AJ-01]=01 when the PID output reaches a negative value, the PID output is limited to 0.
- If [AJ-01]=02 when the PID output reaches a negative value, the PID output lets out an inverted output.
- By turning on the input terminal 043[PID2], the PID2 output becomes 0.

Code/Name	Range (unit)	Initial value
<b>AJ-02</b> PID2 deviation inversion	00(Disable)/01(Enable)	00

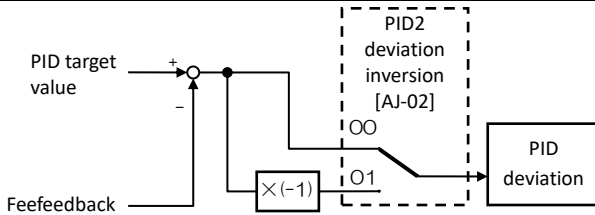

- PID2 deviation can be reversed.

Code/Name	Range (unit)	Initial value
<b>AJ-03</b> PID2 unit selection	refer <unit table> of the end of this chapter.	01
<b>AJ-04</b> PID2 scale adjustment (0%)	-10000 to 10000	0
<b>AJ-05</b> PID2 scale adjustment (100%)	-10000 to 10000	10000
<b>AJ-06</b> PID2 scale adjustment (decimal point position)	0 to 4	2

- The unit and display data related to the output of the PID control can be changed.

Code/Name	Range (unit)	Initial value
<b>AJ-07</b> PID2 set-point input source selection	00 to 13, 15 *2)	07
<b>AJ-10</b> PID2 set-point setting	-100.00 to 100.00(%)*1)	0.00

\*1) Range will depend on the parameters [AJ-04] [AJ-05] [AJ-06]

- When PID2 target value input is selected, if the selected is the parameter setting, [AJ-10] is enabled.

Code/Name	Range (unit)	Initial value
<b>AJ-12</b> PID2 feedback input source selection	00 to 06/08 to 13 *2)	02

- Selects the PID2 feedback reference.

\*2) 00(Not sed)/01(Terminal[Ai1])/02(Terminal[Ai2])/03(Terminal[Ai3])/04(Terminal[Ai4])/05(Terminal[Ai5])/06(Terminal[Ai6])/07(Parameter setting)/08(RS485)/09(Option-1)/10(Option-2)/11(Option-3)/12(Pulse train input (internal)/13(Pulse train input (option)/15(PID1 output)

Code/Name	Range (unit)	Initial value
<b>AJ-13</b> PID2 proportional gain	0.0 to 100.0	1.0
<b>AJ-14</b> PID2 integral time constant	0.0 to 3600.0(s)	1.0
<b>AJ-15</b> PID2 derivative gain	0.00 to 100.00(s)	0.00

- The PID2 gains are set by the above parameters.
- If input terminal 044[PIDC2] is active (ON), the value of the integral constant is cleared. If it is done while the inverter is in running, the driving condition may become unstable.

Code/Name	Range (unit)	Initial value
<b>AJ-16</b> PID2 output range	0.00 to 100.00(%)	0.00

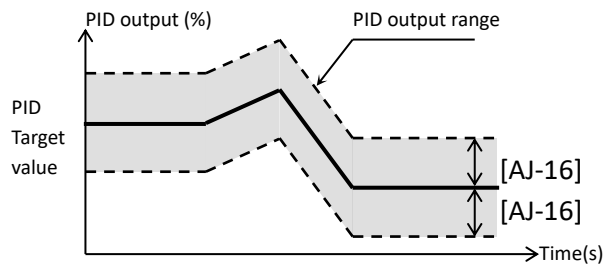

- [AJ-16] Limits the output range of the PID. If [AJ-16] =0.00 the limit is disabled.

Code/Name	Range (unit)	Initial value
<b>AJ-17</b> PID2 over deviation level	0.00 to 100.00(%)	3.00

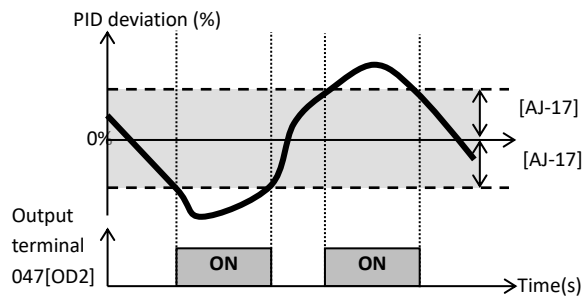

- When the PID deviation pass over  $\pm$ [AJ-17], the output terminal 047[OD2] is activated.

Code/Name	Range (unit)	Initial value
<b>AJ-18</b> Turn-off level for the PID2 feedback compare signal	0.00 to 100.00(%)	100.00
<b>AJ-19</b> Turn-on level for the PID2 feedback compare signal	0.00 to 100.00(%)	0.00

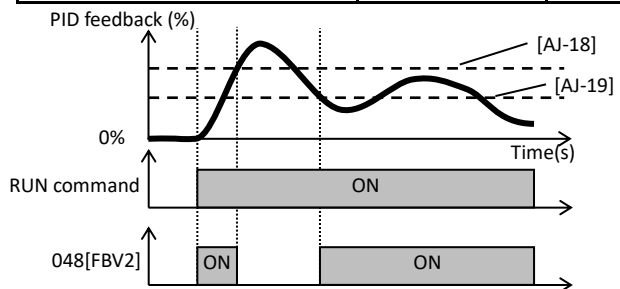

- When the PID feedback cross over the [AJ-18] level, the output terminal 048[FBV2] is OFF. If the PID feedback crosses under the [AJ-19] level, 048[FBV2] is turned ON.



[AJ-21] to [AJ-32]

[AJ-33] to [AJ-39]

**PID3 function**

Code/Name	Range (unit)	Initial value
<b>AJ-21</b> PID3 enable	00(Disable)/01(Enable)/02(Enable (with inverted output))	00

- The PID3 function is enabled with the above parameter.
- If [AJ-21]=01 when the PID output reaches a negative value, the PID output is limited to 0.
- If [AJ-21]=02 when the PID output reaches a negative value, the PID output lets out an inverted output.
- By turning on the input terminal 045[PID3], the PID3 output becomes 0.

Code/Name	Range (unit)	Initial value
<b>AJ-22</b> PID3 deviation inversion	00(Disable)/01(Enable)	00

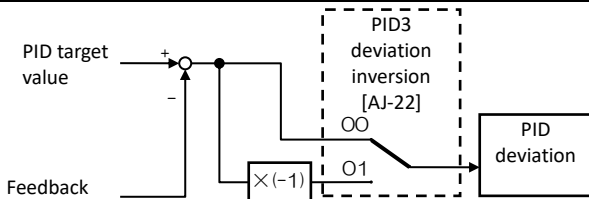

- PID3 deviation can be reversed.

Code/Name	Range (unit)	Initial value
<b>AJ-23</b> PID3 unit selection	refer <unit table> of the end of this chapter.	01
<b>AJ-24</b> PID3 scale adjustment (0%)	-10000 to 10000	0
<b>AJ-25</b> PID3 scale adjustment (100%)	-10000 to 10000	10000
<b>AJ-26</b> PID3 scale adjustment (decimal point position)	0 to 4	2

- You can switch the display data and the display unit involved in the output of the PID control by the calculation.

Code/Name	Range (unit)	Initial value
<b>AJ-27</b> PID3 set-point input source selection	00 to 13 *1)	07
<b>AJ-30</b> PID3 set-point setting	-100.00 to 100.00(%) *2)	0.00

\*2) Range will depend on the parameters [AJ-24] [AJ-25] [AJ-26]

- When PID3 target value input is selected, if the selected is the parameter setting, [AJ-30] is enabled.

Code/Name	Range (unit)	Initial value
<b>AJ-32</b> PID3 feedback input source selection	00 to 06/08 to 13 *1)	01

- Selects the PID3 feedback reference.

\*1) 00(Not used)/01(Terminal[Ai1])/02(Terminal[Ai2])/03(Terminal[Ai3])/04(Terminal[Ai4])/05(Terminal[Ai5])/06(Terminal[Ai6])/07(Parameter setting)/08(RS485)/09(Option-1)/10(Option-2)/11(Option-3)/12(Pulse train input (internal))/13(Pulse train input (option))

Code/Name	Range (unit)	Initial value
<b>AJ-33</b> PID3 proportional gain	0.0 to 100.0	1.0
<b>AJ-34</b> PID3 integral time constant	0.0 to 3600.0(s)	1.0
<b>AJ-35</b> PID3 derivative gain	0.00 to 100.00(s)	0.00

- The PID3 gains are set by the above parameters.
- If input terminal 046[PIDC3] is active (ON), the value of the integral constant is cleared. If it is done while the inverter is in running, the driving condition may become unstable.

Code/Name	Range (unit)	Initial value
<b>AJ-36</b> PID3 output variable	0.00 to 100.00(%)	0.00

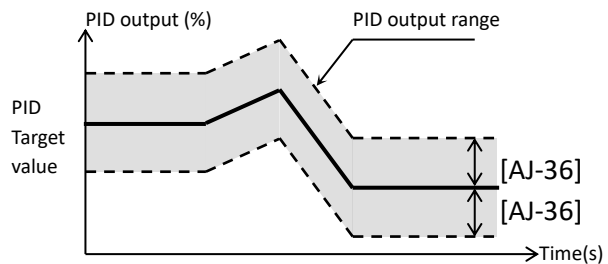

- [AJ-36] Limits the output range of the PID. If [AJ-36] =0.00 the limit is disabled.

Code/Name	Range (unit)	Initial value
<b>AJ-37</b> PID3 over deviation level	0.00 to 100.00(%)	3.00

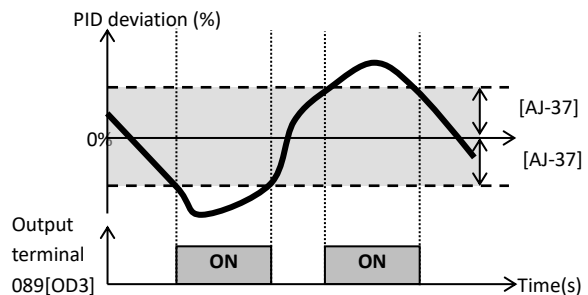

- When the PID deviation pass over  $\pm$ [AJ-37], the output terminal 089[OD3] is activated.

Code/Name	Range (unit)	Initial value
<b>AJ-38</b> Turn-off level for the PID3 feedback compare signal	0.00 to 100.00(%)	100.00
<b>AJ-39</b> Turn-on level for the PID3 feedback compare signal	0.00 to 100.00(%)	0.00

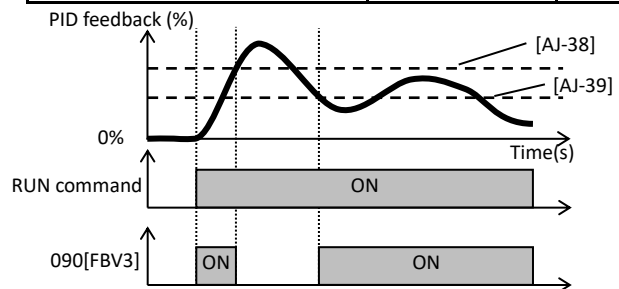

- When the PID feedback cross over the [AJ-38] level, the output terminal 090[FBV3] is OFF. If the PID feedback crosses under the [AJ-39] level, 090[FBV3] is turned on.

[AJ-41] to [AJ-52]

**PID4 function**

Code/Name	Range (unit)	Initial value
<b>AJ-41</b> PID4 enable	00(Disable)/01(Enable)/02(Enable (with inverted output))	00

- The PID4 function is enabled with the above parameter.
- If [AJ-41]=01 when the PID output reaches a negative value, the PID output is limited to 0.
- If [AJ-41]=02 when the PID output reaches a negative value, the PID output lets out an inverted output.
- By turning on the 047[PID4] terminal, the PID4 output becomes 0.

Code/Name	Range (unit)	Initial value
<b>AJ-42</b> PID4 deviation inversion	00(Disable)/01(Enable)	00

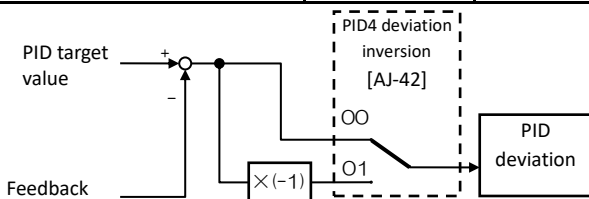

- PID4 deviation can be reversed.

Code/Name	Range (unit)	Initial value
<b>AJ-43</b> PID4 unit selection	refer <unit table> of the end of this chapter.	01
<b>AJ-44</b> PID4 scale adjustment (0%)	-10000 to 10000	0
<b>AJ-45</b> PID4 scale adjustment (100%)	-10000 to 10000	10000
<b>AJ-46</b> PID4 scale adjustment (decimal point position)	0 to 4	2

- You can switch the display data and the display unit involved in the output of the PID control by the calculation.

Code/Name	Range (unit)	Initial value
<b>AJ-47</b> PID4 set-point input source selection	00 to 13 *1)	07
<b>AJ-50</b> PID4 set-point setting	-100.00 to 100.00(%)*2)	0.00

\*2) Range will depend on the parameters [AJ-44] [AJ-45] [AJ-46]

- When PID4 target value input is selected, if the selected is the parameter setting, [AJ-50] is enabled.

Code/Name	Range (unit)	Initial value
<b>AJ-52</b> PID4 feedback input source selection	00 to 06/08 to 13 *1)	01

- Selects the PID4 feedback reference.

\*1) 00(Not used)/01(Terminal[Ai1])/02(Terminal[Ai2])/03(Terminal[Ai3])/04(Terminal[Ai4])/05(Terminal[Ai5])/06(Terminal[Ai6])/07(Parameter setting)/08(RS485)/09(Option-1)/10(Option-2)/11(Option-3)/12(Pulse train input (internal))/13(Pulse train input (option))

[AJ-53] to [AJ-59]

Code/Name	Range (unit)	Initial value
<b>AJ-53</b> PID4 proportional gain	0.0 to 100.0	1.0
<b>AJ-54</b> PID4 integral time constant	0.0 to 3600.0(s)	1.0
<b>AJ-55</b> PID4 derivative gain	0.00 to 100.00(s)	0.00

- The PID4 gains are set by the above parameters.
- If input terminal 048[PIDC4] is active (ON), the value of the integral constant is cleared. If it is done while the inverter is in running, the driving condition may become unstable.

Code/Name	Range (unit)	Initial value
<b>AJ-56</b> PID4 output range	0.00 to 100.00(%)	0.00

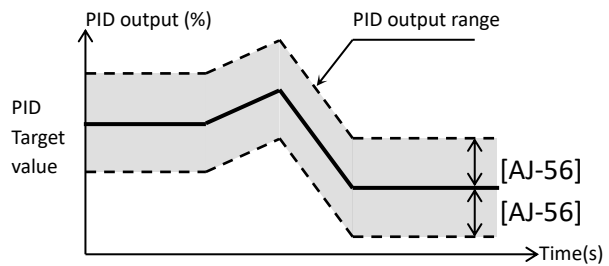

- [AJ-56] Limits the output range of the PID. If [AJ-56] =0.00 the limit is disabled.

Code/Name	Range (unit)	Initial value
<b>AJ-57</b> PID4 over deviation level	0.00 to 100.00(%)	3.00

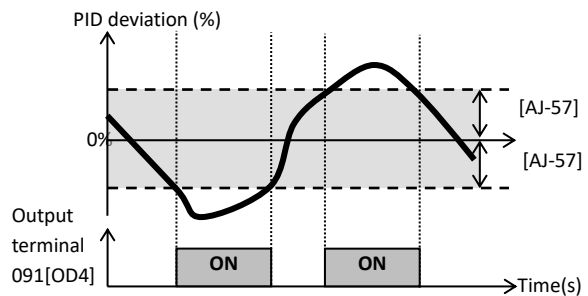

- When the PID deviation pass over  $\pm$ [AJ-57], the output terminal function 091[OD4] is activated.

Code/Name	Range (unit)	Initial value
<b>AJ-58</b> Turn-off level for the PID4 feedback compare signal	0.00 to 100.00(%)	100.00
<b>AJ-59</b> Turn-on level for the PID4 feedback compare signal	0.00 to 100.00(%)	0.00

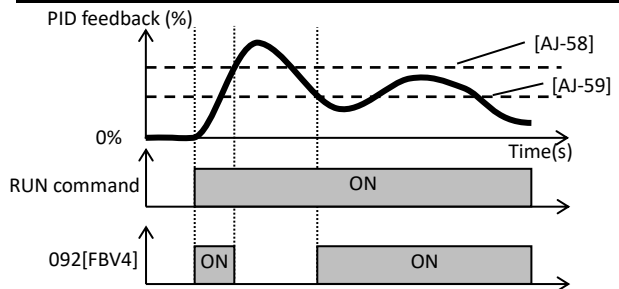

- When the PID feedback cross over the [AJ-58] level, the output terminal 092[FBV4] is OFF. If the PID feedback crosses under the [AJ-59] level, 092[FBV4] is turned ON.

[bA101] to [bA116]

■ Parameter mode (b code)

Frequency limit

Code/Name	Range (unit)	Initial value
<b>bA101</b> Upper frequency limit source selection, 1st-motor	00(Disable)/ 01(Terminal[Ai1])/02(Terminal[Ai2])/03(Terminal[Ai3])/04(Terminal[Ai4])/05(Terminal[Ai5])/06(Terminal[Ai6])/07(Parameter Setting)/08(RS485)/09(Option-1)/10(Option-2)/11(Option-3)/12(Pulse train input(internal))/13(Pulse train input(option))	00
<b>bA102</b> Upper frequency limit, 1st-motor	0.00 to 590.00(Hz)	0.00
<b>bA103</b> Lower frequency limit, 1st-motor	0.00 to 590.00(Hz)	0.00

- The upper and lower limits of the frequency reference are set by the above parameters.

Torque limit

Code/Name	Range (unit)	Initial value
<b>bA110</b> Torque limit selection, 1st-motor	00(Disable)/01(Terminal[Ai1])/02(Terminal[Ai2])/03(Terminal[Ai3])/04(Terminal[Ai4])/05(Terminal[Ai5])/06(Terminal[Ai6])/07(Parameter Setting)/08(RS485)/09(Option1)/10(Option2)/11(Option3)	07
<b>bA111</b> Torque limiting parameters mode selection, 1st-motor	00(4 quadrants)/01(Switch by [TRQ1]/[TRQ2] terminals)	00
<b>bA112</b> Torque limit 1 (Forward drive), 1st-motor	0.0 to 500.0(%)	150.0(%)
<b>bA113</b> Torque limit 2 (Reverse regenerative), 1st-motor	0.0 to 500.0(%)	150.0(%)
<b>bA114</b> Torque limit 3 (Reverse drive), 1st-motor	0.0 to 500.0(%)	150.0(%)
<b>bA115</b> Torque limit 4 (Forward regenerative), 1st-motor	0.0 to 500.0(%)	150.0(%)
<b>bA116</b> Torque limit LADSTOP selection, 1st-motor	00(Disable)/01(Enable)	00

- The torque limit function is effective for vector control. (with sensor, sensorless, 0Hz range sensorless).
- If the input terminal 060[TL] torque limit enabled is not assigned, [bA110] is always enabled. When input terminal 060 [TL] is assigned and turned on, the torque limit function [bA110] becomes valid. When it is off, the torque limit value becomes the maximum value in the data setting range.
- When the torque is limited, the output terminal 022[TRQ] torque limiting signal is ON.

[bA120] to [bA128]

Overcurrent suppression function setting

Code/Name	Range (unit)	Initial value
<b>bA120</b> Overcurrent suppression enable, 1st-motor	00(Disable)/01(Enable)	00
<b>bA121</b> Overcurrent suppression level, 1st-motor	Inverter rated Current $\times(0.0$ to $2.0)(A)$	Inverter rated current $\times 1.8$

- Overcurrent can be suppressed, but in that case there is a possibility the motor become in a step-out state. Disable Overcurrent suppression in case an inverter is used in crane.

Overload restriction function setting

Code/Name	Range (unit)	Initial value
<b>bA122</b> Overload restriction 1 mode selection, 1st-motor	00(Disable)/01(Enable during accel. and constant speed)/02(Constant speed only)/03(Enable during accel. and constant speed (accel. during regeneration))	01
<b>bA123</b> Overload restriction 1 active level, 1st-motor	Inverter rated current $\times(0.2$ to $2.0)(A)$	Inv rated current $\times 1.5(A)$
<b>bA124</b> Overload restriction 1 action time, 1st-motor	0.10 to 3600.00(s)	1.00
<b>bA126</b> Overload restriction 2 mode selection, 1st-motor	00(Disable)/01(Enable during accel. and constant speed)/02(Constant speed only)/03(Enable during accel. and constant speed (accel. during regeneration))	01
<b>bA127</b> Overload restriction 2 active level, 1st-motor	Inverter rated current $\times(0.2$ to $2.0)(A)$	Inv rated current $\times 1.5(A)$
<b>bA128</b> Overload restriction 2 action time, 1st-motor	0.10 to 3600.00(s)	1.00

- When the current is increased over "Overload restriction level", the overload restriction function reduces the current automatically by lowering the frequency.

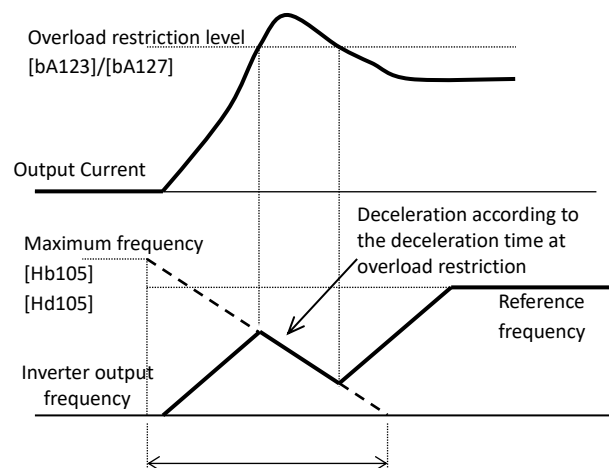

- Using input terminal 038[OLR] state, the overload restriction 1(OFF) and overload restriction 2(ON) can be used.

## [bA-30] to [bA145]

## Deceleration / stop at power loss (Non-stop)

Code/Name	Range (unit)	Initial value
<b>bA-30</b> Instantaneous power failure non-stop function, mode selection	00(Disable)/ 01(Deceleration-stop)/ 02 (Voltage controlled decel-stop(without recovery)) / 03 (Voltage controlled decel-stop (with recovery))	00
<b>bA-31</b> Instantaneous power failure non-stop function, start voltage level	(200V class) 0.0 to 410.0(VDC) (400V class) 0.0 to 820.0(VDC)	(200V class) 220.0 (400V class) 440.0
<b>bA-32</b> Instantaneous power failure non-stop function, target voltage level	(200V class) 0.0 to 410.0(VDC) (400V class) 0.0 to 820.0(VDC)	(200V class) 360.0 (400V class) 720.0
<b>bA-34</b> Instantaneous power failure non-stop function, deceleration time	0.01 to 3600.00(s)	1.00
<b>bA-36</b> Instantaneous power failure non-stop function, start frequency decrement	0.00 to 10.00(Hz)	0.00
<b>bA-37</b> Instantaneous power failure non-stop function, DC bus voltage control P gain	0.00 to 5.00	0.20
<b>bA-38</b> Instantaneous power failure non-stop function, DC bus voltage control I gain	0.00 to 150.00(s)	1.00

- If the DC bus voltage of the main circuit is lower than the level of [bA-31], the inverter decelerates to create a regenerative state.
- When [bA-30]=01, if the DC bus voltage drops under [bA-31], the current frequency reference is decreased by [bA-36] setting and decelerates depending on the [bA-34] setting. if the DC bus voltage rises to the [bA-32] setting, the deceleration stops once.
- When [bA-30] = 02/03, at the time of DC bus voltage drop, deceleration is performed to regenerate and the DC bus voltage is maintained at the [bA-32] set value by PI control.
- During Instantaneous power failure non-stop deceleration, output terminal O23[IPS] turns ON.

## Overvoltage suppression - deceleration

Code/Name	Range (unit)	Initial value
<b>bA140</b> Overvoltage suppression enable setting, 1st-motor	00(Disable)/ 01(Constant DC bus voltage control(deceleration stop)) 02(Enable acceleration)/ 03(Enable acceleration (at constant speed and deceleration))	00
<b>bA141</b> Overvoltage suppression active level, 1st-motor	(200V class) 330.0 to 400.0(VDC) (400V class) 660.0 to 800.0(VDC)	(200V class) 380 (400V class) 760
<b>bA142</b> Overvoltage suppression active time, 1st-motor	0.00 to 3600.00(s)	1.00
<b>bA144</b> Constant DC bus voltage control P gain, 1st-motor	0.00 to 5.00	0.20
<b>bA145</b> Constant DC bus voltage control I gain, 1st-motor	0.00 to 150.00(s)	1.00

- When [bA140] = 01, the inverter stops with the deceleration time extended so that the DC bus voltage do not cross over the [bA141] level.
- When [bA140] = 02, 03, the inverter accelerates once so that the DC bus voltage do not cross over [bA141] level.

## [bA146] to [bA-63]

## Overvoltage suppression - Over-excitation

Code/Name	Range (unit)	Initial value
<b>bA146</b> Over-magnetization function selection, 1st-motor	00(Disable)/ 01(Always enable)/ 02(At deceleration only)/ 03(Operation at setting level)/ 04(Operation at setting level at deceleration only)	02
<b>bA147</b> Over-magnetization function output filter time constant, 1st-motor	0.00 to 1.00(s)	0.30
<b>bA148</b> Over-magnetization function voltage gain, 1st-motor	50 to 400(%)	100
<b>bA149</b> Over-magnetization function level setting, 1st-motor	(200V Class) 330.0 to 400.0(VDC) (400V Class) 660.0 to 800.0(VDC)	(200V Class) 360 (400V Class) 720

- This function disables the AVR(Automatic output Voltage Regulation) function, works while in over-excitation.
- This function is effective when control method [AA121/AA221] is set 00 to 02 or 04 to 06 (V/f control).
- When [bA146]=03/04, it will be operative if DC bus voltage exceeds [bA-149] level.

## Dynamic braking (BRD) function

Code/Name	Range (unit)	Initial value
<b>bA-60</b> Dynamic brake use ratio	*1)	10.0
<b>bA-61</b> Dynamic brake activation selection	00(Disable)/ 01(Only while running) 02(Enable during stop)	00
<b>bA-62</b> Dynamic brake activation level	(200V class) 330.0 to 400.0(VDC) (400V class) 660.0 to 800.0(VDC)	(200V class) 360.0 (400V class) 720.0
<b>bA-63</b> Dynamic brake resistor value	Inverter minimum resistor value to 600(Ω)	Minimum resistance

- \*1) The [bA-60] setting range is  $0.0 \text{ to } 10.0 \times \frac{[(bA-63)]}{(\text{Inverter minimum resistor})}^2 (\%)$ .
- This function sets the behavior of the built-in braking circuits.
  - When using the external braking unit, these parameters need not be set.
  - Regarding the built-in braking circuit models and the connectable minimum resistance value, refer to the specification table in Chapter 7.

[bA-70] to [bA-71][bA201] to [bA249]

[bb101] to [bb-23]

**Cooling-fan operation**

Code/Name	Range (unit)	Initial value
<b>bA-70</b> Cooling fan control method selection	00(Always ON)/ 01(While inverter operates)/ 02(Depends on temperature)	00
<b>bA-71</b> Clear accumulated cooling fan run time monitor	00(Disable)/01(Clear)	00

- The Inverter cooling fan can be stopped.
- If you change the cooling-fan, assigning [bA-71]=01 you will be able to clear the accumulated operation time.

**2nd motor** When Intelligent Input terminal 024[SET] is enabled.

Code/Name	Range (unit)	Initial value
<b>bA201</b> Upper frequency limit source selection, 2nd-motor	Same as bA101	
<b>bA202</b> Upper Frequency limit, 2nd-motor	Same as bA102	
<b>bA203</b> Lower Frequency limit, 2nd-motor	Same as bA103	
<b>bA210</b> Torque limit selection, 2nd-motor	Same as bA110	
<b>bA211</b> Torque limiting parameters mode selection, 2nd-motor	Same as bA111	
<b>bA212</b> Torque limit 1 (Forward drive), 2nd-motor	Same as bA112	
<b>bA213</b> Torque limit 2 (Reverse regenerative), 2nd-motor	Same as bA113	
<b>bA214</b> Torque limit 3 (Reverse drive), 2nd-motor	Same as bA114	
<b>bA215</b> Torque limit 4 (Forward regenerative), 2nd-motor	Same as bA115	
<b>bA216</b> Torque limit LADSTOP selection, 2nd-motor	Same as bA116	
<b>bA220</b> Overcurrent suppression enable, 2nd-motor	Same as bA120	
<b>bA221</b> Overcurrent suppression level, 2nd-motor	Same as bA121	
<b>bA222</b> Overload restriction 1 mode selection, 2nd-motor	Same as bA122	
<b>bA223</b> Overload restriction 1 active level, 2nd-motor	Same as bA123	
<b>bA224</b> Overload restriction 1 action time, 2nd-motor	Same as bA124	
<b>bA226</b> Overload restriction 2 mode selection, 2nd-motor	Same as bA126	
<b>bA227</b> Overload restriction 2 active level, 2nd-motor	Same as bA127	
<b>bA228</b> Overload restriction 2 action time, 2nd-motor	Same as bA128	
<b>bA240</b> Overvoltage suppression enable, 2nd-motor	Same as bA140	
<b>bA241</b> Overvoltage suppression active level, 2nd-motor	Same as bA141	
<b>bA242</b> Overvoltage suppression active time, 2nd-motor	Same as bA142	
<b>bA244</b> Constant DC bus voltage control P gain, 2nd-motor	Same as bA144	
<b>bA245</b> Constant DC bus voltage control I gain, 2nd-motor	Same as bA145	
<b>bA246</b> Over magnetization function selection, 2nd-motor	Same as bA146	
<b>bA247</b> Over magnetization function output filter time constant, 2nd-motor	Same as bA147	
<b>bA248</b> Over magnetization function voltage gain, 2nd-motor	Same as bA148	
<b>bA249</b> Over magnetization function level setting, 2nd-motor	Same as bA149	

**Reduction of electromagnetic sound**

Code/Name	Range (unit)	Initial value
<b>bb101</b> Carrier frequency setting, 1st-motor	<ul style="list-style-type: none"> <li>• 200V P1-004L to P1-550L 400V P1-007H to P1-550H [Ub-03]= 02(ND): 0.5 to 16.0(kHz) 01(LD): 0.5 to 12.0(kHz) 00(VLD): 0.5 to 10.0(kHz)</li> <li>• 400V P1-750H or above [Ub-03]= 02(ND): 0.5 to 10.0(kHz) 01(LD): 0.5 to 8.0(kHz) 00(VLD):0.5 to 8.0(kHz)</li> </ul>	2.0
<b>bb102</b> Sprinkle carrier pattern selection, 1st-motor	00(Disable)/ 01(Enable: Patern-1)/ 02(Enable: Patern-2)/ 03(Enable: Patern-3)	00
<b>bb103</b> Automatic carrier reduction selection, 1st-motor	00(Disable)/ 01(Enable: Current)/ 02(Enable: Temperature)	00

- To decrease high frequency electromagnetic noise, [bb101] should be set small. To lower motor sound loudness, [bb101] has to be set bigger.
- The carrier frequency may be internally limited depending on the setting of Load type selection [Ub-03].
- For the sake of the inverter protection, the Automatic carrier reduction [bb103] decreases the carrier in certain cases.

**Reset operation after error event**

Code/Name	Range (unit)	Initial value
<b>bb-10</b> Automatic error reset selection	00(Disable)/ 01(If RUN command is OFF) 02(After set time)	00
<b>bb-11</b> Alarm signal selection at automatic error reset	00(Enable)/ 01(Disable)	00
<b>bb-12</b> Automatic error reset wait time	0 to 600(s)	2
<b>bb-13</b> Automatic error reset number	0 to 10(count)	3

- Adjustment of the automatic reset that follows an error event. In the case that RUN command was on execution, after resetting, the motor re-operates according to the setting of [bb-41] Restart mode after RS release.

**Retry/trip setting in error event**

Code/Name	Range (unit)	Initial value
<b>bb-20</b> Number of retries after instantaneous power failure	0 to 16/255	0
<b>bb-21</b> Number of retries after under voltage	0 to 16/255	0
<b>bb-22</b> Number of retries after overcurrent	0 to 5	0
<b>bb-23</b> Number of retries after over voltage	0 to 5	0

- Set the number of times to retry after each error.
- If 0 is set, as soon as an error occurs, it will trip.
- To retry, set the value of these parameters other than 0.

[bb-24] to [bb-42]

[bb-43] to [bb-62]

**Restart mode after instantaneous power failure/under-voltage error**

Code/Name	Range (unit)	Initial value
<b>bb-24</b> Restart mode selection after instantaneous power failure/under-voltage error	*2)	01
<b>bb-25</b> Instantaneous power failure allowed time	0.3 to 25.0(s)	1.0
<b>bb-26</b> Retry wait time after instantaneous power failure/under-voltage error	0.3 to 100.0(s)	0.3
<b>bb-27</b> Enable instantaneous power failure/ under-voltage trip while in stop status	00(Disable)/01(Enable)/02(Disable at Stop/Decel. stop)	00
<b>bb-28</b> Restart mode selection after an overcurrent error	*2)	01
<b>bb-29</b> Retry wait time after an overcurrent error	0.3 to 100.0(s)	0.3
<b>bb-30</b> Restart mode selection after an overvoltage error	*2)	01
<b>bb-31</b> Retry wait time after an overvoltage error	0.3 to 100.0(s)	0.3

- \*2) 00(Restart at 0Hz)/01(Restart with matching frequency)/02(Restart with active frequency matching)/03(Detect speed)/04(Decelerate and stop with matching frequency and then trip)
- Regarding the restart, after the waiting time is completed the selected restart method is carried out.

**Restart mode after FRS/RS**

Code/Name	Range (unit)	Initial value
<b>bb-40</b> Restart mode after FRS release	00(Restart at 0Hz)/01(Restart with matching frequency)/02(Restart with active frequency matching)/	00
<b>bb-41</b> Restart mode after RS release	03(Detect speed) *3)	00

- \*3) This function requires encoder feedback to the P1-FB option or to the input terminals [A]/[B] assigned 103[PLA]/104[PLB].
- When using input terminal 032[FRS] and 028[RS], restart mode can be selected.
  - By [bb-40], input terminal 032 [FRS] Free run ON and restart operation after free run at stop are selected.
  - [bb-41] selects not only the operation after input terminal 028[RS] reset, but also the restart operation after reset by power supply shutdown and the restart operation after reset release at trip.
  - When the input terminal 035[CS] commercial power supply change is turned ON, the inverter will be in free running state, and restart with matching frequency will be performed after [bb-26] time has elapsed. For more information, refer to the P1 user's guide.

**Minimum level of frequency matching**

Code/Name	Range (unit)	Initial value
<b>bb-42</b> Frequency matching minimum restart frequency	0.00 to 590.00(Hz)	0.00

- The matching frequency function adopts the motor frequency for a shockless start-up.
- If at the restart the frequency is under the [bb-42] frequency, a 0Hz restart will be used instead.

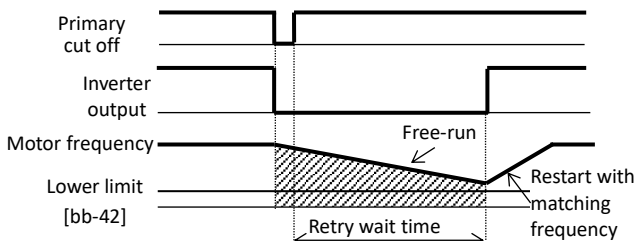

**Active frequency matching**

Code/Name	Range (unit)	Initial value
<b>bb-43</b> Active frequency matching restart level	Inverter rated current $\times(0.2$ to $2.0)$ (A)	Inverter rated current $\times 1.0$
<b>bb-44</b> Active frequency matching restart constant(speed)	0.10 to 30.00(s)	0.50
<b>bb-45</b> Active frequency matching restart constant (voltage)	0.10 to 30.00(s)	0.50
<b>bb-46</b> OC-supress level at active frequency matching	Inverter rated current $\times(0.0$ to $2.0)$ (A)	Inverter rated current $\times 1.0$
<b>bb-47</b> Active frequency matching restart speed selection	00(Output requery at shut down)/01(Maximum frequency)/02(Setting frequency)	00
<b>bb-50</b> Frequency matching filter gain *4)	0 to 1000(%)	50

- \*4) [bb-50] is a parameter added to Ver2.03 or later.
- If the actual rotation of the motor does not match the reference frequency, this function is a restart method that lowers the starting voltage so that the output current does not exceed [bb-43] and reduces the reference frequency to match the motor speed.

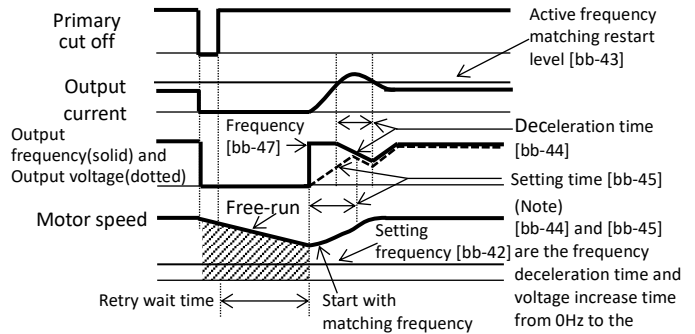

**Overcurrent level**

Code/Name	Range (unit)	Initial value
<b>bb160</b> Overcurrent detection level, 1st-motor	Inverter rated ND current $\times (0.2$ to $2.2)$ (A)	Inverter ND rated current $\times 2.2$ (A)

- The motor protection level for overcurrent can be set.
- In the case of a permanent magnet motor, set this parameter lower than the motor demagnetizing level.

**Overvoltage warning**

Code/Name	Range (unit)	Initial value
<b>bb-61</b> Power supply overvoltage selection	00(Warning)/01(Error)	00
<b>bb-62</b> Power supply overvoltage level setting	(200V Class) 300.0 to 410.0(VDC) (400V Class) 600.0 to 820.0(VDC)	(200V Class) 390.0 (400V Class) 780.0

- When the power supply suffers an overvoltage and if the DC bus voltage is higher than the value in [bb-62], a warning is issued in accordance with [bb-61].
- If [bb-61] is 01, the output terminal 081 [OVS]"Overvoltage power Supply" signal turns on and trips with [E015] error. If [bb-61] is 00, only the output terminal 081[OVS] signal is ON.

**Selection of Ground fault detection**

Code/Name	Range (unit)	Initial value
<b>bb-64</b> Detect ground fault selection	00(Disable)/01(Enable)	01

- Ground fault detection enable/disable is selectable.

[bb-65] to [bb260]

Phase loss detection

Code/Name	Range (unit)	Initial value
<b>bb-65</b> Input phase loss detection enable	00(Disable)/01(Enable)	00
<b>bb-66</b> Output phase loss detection enable	00(Disable)/01(Enable)	00
<b>bb-67</b> Output phase loss detection sensitivity	1 to 100(%)	10

- Above function detects the disconnection of the supply RST input line and UVW output line.

Thermistor error detection

Code/Name	Range (unit)	Initial value
<b>bb-70</b> Thermistor error level	0 to 10000( $\Omega$ )	3000
<b>Cb-40</b> Thermistor type selection	00(Disable)/01(PTC)/02(NTC)	00

- The kind of thermistor specified in [Cb-40] must be attached to [TH] terminal.  
If [Cb-40]=01 or 02, error level must be set in [bb-70].

Over-speed detection

Code/Name	Range (unit)	Initial value
<b>bb-80</b> Over-speed detection level	0.0 to 150.0(%)	135.0
<b>bb-81</b> Over-speed detection time	0.0 to 5.0(s)	0.5

- In vector control, when speed surpass "maximum speed" x [bb-80] for more than the [bb-81] time, it will result in an error.

Abnormal deviation in speed control

Code/Name	Range (unit)	Initial value
<b>bb-82</b> Speed deviation error mode selection	00(Warning)/01(Error)	00
<b>bb-83</b> Speed deviation error detection level	0.0 to 100.0(%)	15.0
<b>bb-84</b> Speed deviation error detection time	0.0 to 5.0(s)	0.5

- In vector control, if the time which the speed deviation (absolute of [dA-12]-[dA-08] ) is greater than the "maximum frequency setting" x [bb-83] exceeds [bb-84] value , an error or warning will occur and the output terminal 041[DSE] turn ON.

Abnormal deviation in position control

Code/Name	Range (unit)	Initial value
<b>bb-85</b> Position deviation error mode selection	00(Warning)/01(Error)	00
<b>bb-86</b> Position deviation error detection level	0 to 65535 ( $\times 100$ pulse)	4096
<b>bb-87</b> Position deviation error detection time	0.0 to 5.0(s)	0.5

- In position control, an error will occur if the time that position deviation is greater than [bb-86] exceeds [bb-87].
- When the input terminal 072[PCLR] is turned ON, the position deviation is cleared.

2nd motor When Intelligent Input terminal 024[SET] is enabled.

Code/Name	Range (unit)	Initial value
<b>bb201</b> Carrier frequency setting, 2nd-motor	Same as bb101	
<b>bb202</b> Sprinkle carrier pattern selection, 2nd-motor	Same as bb102	
<b>bb203</b> Automatic carrier reduction selection, 2nd-motor	Same as bb103	
<b>bb260</b> Overcurrent detection level, 2nd-motor	Same as bb160	

[bC110] to [bC125]

Electronic thermal protection for the motor

Code/Name	Range (unit)	Initial value
<b>bC110</b> Electronic thermal level setting, 1st-motor	Inverter rated current $\times$ (0.0 to 3.0)(A)	Inverter rated current $\times 1.0$ (A)
<b>bC111</b> Electronic thermal characteristic selection, 1st-motor	00(Reduced torque (VT))/01(Constant torque (CT))/02(Free setting)	00(JPN)/01(EU)(USA)(ASIA)(CHN)
<b>bC112</b> Electronic thermal decrease function enable, 1st-motor	00(Disable)/01(Enable)	01
<b>bC113</b> Electronic thermal decreasing time, 1st-motor	1 to 1000(s)	600
<b>bC-14</b> Store electronic thermal counter at power-off	00(Disable)/01(Enable)	01
<b>bC120</b> Free electronic thermal frequency-1, 1st-motor	0.00 to bC122(Hz)	0.00
<b>bC121</b> Free electronic thermal current-1, 1st-motor	Inverter rated current $\times$ (0.0 to 3.0)(A)	0.0
<b>bC122</b> Free electronic thermal frequency-2, 1st-motor	bC120 to bC124(Hz)	0.00
<b>bC123</b> Free electronic thermal current-2, 1st-motor	Inverter rated current $\times$ (0.0 to 3.0)(A)	0.0
<b>bC124</b> Free electronic thermal frequency-3, 1st-motor	bC122 to 590.00(Hz)	0.00
<b>bC125</b> Free electronic thermal current-3, 1st-motor	Inverter rated current $\times$ (0.0 to 3.0)(A)	0.0

- The setting of [bC112] enables subtraction of the motor's thermal integration value. If [bC113] is lowered from the initial value, the risk of motor burnout may increase, so set it appropriately according to the heat dissipation characteristics of the motor.

(Example 1)

When [bC111]=00, Inverter rated current:64A, [bC110]=64(A), Base frequency [Hb104]=50Hz or 60Hz, Output frequency=20Hz

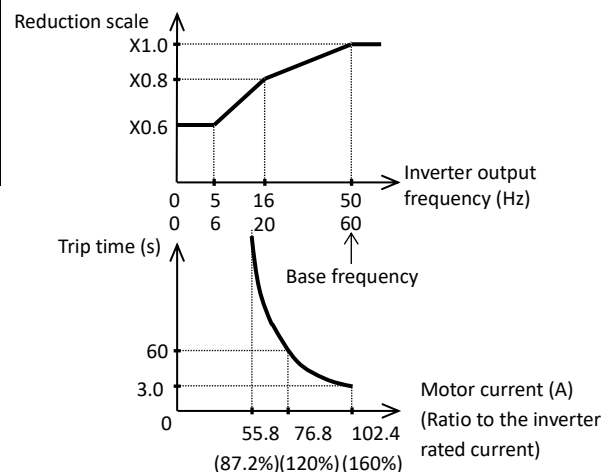

- In case of output frequency = 16Hz (base=50Hz) or 20Hz (base = 60Hz), the reduction scale is  $\times 0.8$ , then the inverter will trip when the output current of 120%(150% $\times 0.8$ ) flows continuously within 60s according to the curve.

[bC210] to [bC225]

(Example 2)

When [bC111]=01, Inverter rated current:64A, [bC110]=64(A), Base frequency[Hb103]=60Hz, Output frequency=2.5Hz

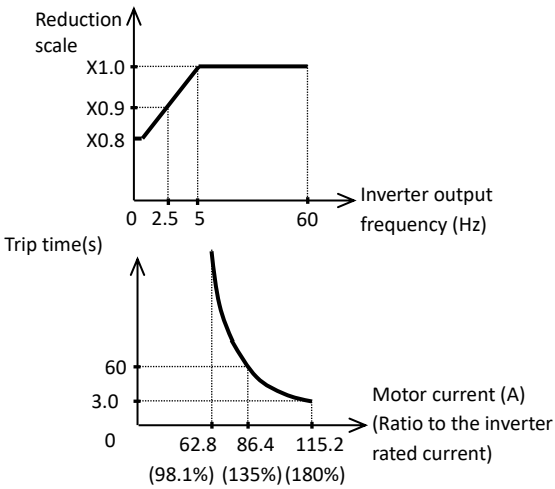

- In case of output frequency = 2.5Hz, the reduction scale is x0.9, then, the inverter will trip when the output current of 135%(=150%×0.9) flows continuously within 60s according to the curve.

(Example 3) When [bC111] = 02, and Output frequency = [bC122]

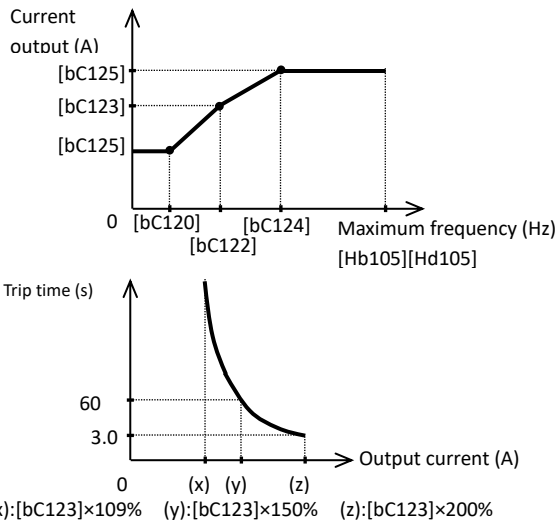

2nd motor When Intelligent Input terminal 024[SET] is enabled.

Code/Name	Range (unit)	Initial value
<b>bC210</b> Electronic thermal level setting, 2nd-motor	Same as bC110	
<b>bC211</b> Electronic thermal characteristic selection, 2nd-motor	Same as bC111	
<b>bC212</b> Electronic thermal decrease function selection, 2nd-motor	Same as bC112	
<b>bC213</b> Electronic thermal decreasing time, 2nd-motor	Same as bC113	
<b>bC220</b> Free electronic thermal frequency-1, 2nd-motor	Same as bC120	
<b>bC221</b> Free electronic thermal current-1, 2nd-motor	Same as bC121	
<b>bC222</b> Free electronic thermal frequency-2, 2nd-motor	Same as bC122	
<b>bC223</b> Free electronic thermal current-2, 2nd-motor	Same as bC123	
<b>bC224</b> Free electronic thermal frequency-3, 2nd-motor	Same as bC124	
<b>bC225</b> Free electronic thermal current-3, 2nd-motor	Same as bC125	

[bd-01] to [bd-04]

functional Safety terminal (STO)

Code/Name	Range (unit)	Initial value
<b>bd-01</b> STO input display selection	00(Warning(display))/01(Warning(without display))/02(Trip)	00
<b>bd-02</b> STO input change time	0.00 to 60.00(s)	1.00
<b>bd-03</b> Display selection during STO input change time	00(Warning(display))/01(Warning(without display))	00
<b>bd-04</b> Action selection after STO input change time	00(Maintain current status)/01(Disable)/02(Trip)	00

- These are the display setting when the ST1 and ST2 terminals are used. If functional safety certification is required, refer to the SJ-P1 Safety Function Guide (NT2512\*X)

※Notes on electronic thermal function !

The SJ-P1 is implemented with the inverter-protected electronic thermal (not user-configurable) separately the Electronic thermal protection for the motor.

It operates as an electronic thermal with 150% ND rated current and the constant torque characteristics regardless of the setting of [Ub-03] Load type selection. ( Refer to the left (Example 2) ).

Even if [Ub-03] is changed to “Low Duty (LD)” or “Very Low Duty(VLD)”, check the carrier derating at the “Normal Duty” rating. In some cases, E039 Controller (inverter) overload occurs.

- For more information, refer to the P1 User’s guide.



[CA-01] to [CA-31]

■ Parameter mode (C code)

**Intelligent input terminals setting**

Code/Name	Range (unit)	Initial value
<b>CA-01</b> Input terminal [1] function	Reference <Input terminal function list>  103 [PLA] Pulse train input A is restricted to [CA-10],	028(RS)
<b>CA-02</b> Input terminal [2] function		015(SCHG)
<b>CA-03</b> Input terminal [3] function		029(JG)
<b>CA-04</b> Input terminal [4] function		032(FRS)
<b>CA-05</b> Input terminal [5] function		031(2CH)
<b>CA-06</b> Input terminal [6] function		003(CF1)
<b>CA-07</b> Input terminal [7] function		004(CF2)
<b>CA-08</b> Input terminal [8] function		002(RV)
<b>CA-09</b> Input terminal [9] function		001(FW)
<b>CA-10</b> Input terminal [A] function		033(EXT)
<b>CA-11</b> Input terminal [B] function		034(USP)

- The functions for the input terminals 1 to 9,A,B are assigned in [CA-01] to [CA-09],[CA-10],[CA-11].

**Input terminal NO/NC setting**

Code/Name	Range (unit)	Initial value
<b>CA-21</b> Input terminal [1] active state	00(Normally Open: NO)/ 01(Normally Closed: NC)	00
<b>CA-22</b> Input terminal [2] active state		00
<b>CA-23</b> Input terminal [3] active state		00
<b>CA-24</b> Input terminal [4] active state		00
<b>CA-25</b> Input terminal [5] active state		00
<b>CA-26</b> Input terminal [6] active state		00
<b>CA-27</b> Input terminal [7] active state		00
<b>CA-28</b> Input terminal [8] active state		00
<b>CA-29</b> Input terminal [9] active state		00
<b>CA-30</b> Input terminal [A] active state		00
<b>CA-31</b> Input terminal [B] active state		00

- NO/NC for the Intelligent input terminals 1 to 9,A,B are assigned in [CA-21] to [CA-29],[CA-30],[CA-31].
- However, in the case of [RS] assignment the NO/NC will not apply, only NO will apply.

[CA-41] to [CA-55]

**Input terminal chatter prevention**

Code/Name	Range (unit)	Initial value
<b>CA-41</b> Input terminal [1] response time	0 to 400(ms)	2
<b>CA-42</b> Input terminal [2] response time		2
<b>CA-43</b> Input terminal [3] response time		2
<b>CA-44</b> Input terminal [4] response time		2
<b>CA-45</b> Input terminal [5] response time		2
<b>CA-46</b> Input terminal [6] response time		2
<b>CA-47</b> Input terminal [7] response time		2
<b>CA-48</b> Input terminal [8] response time		2
<b>CA-49</b> Input terminal [9] response time		2
<b>CA-50</b> Input terminal [A] response time		2
<b>CA-51</b> Input terminal [B] response time		2

- Above parameters set the time to wait after the input change has ended, and for the input to become stable and responsive.

**Time allowed in simultaneous terminal change**

Code/Name	Range (unit)	Initial value
<b>CA-55</b> Multistage input determination time	0 to 2000(ms)	0

- Sets the dead time for multistage speed and position terminals change.

## [Input terminal function list]

Function code	Symbol	Function name	Description
000	No	Not use	-
001	FW	Forward rotation	Activating (ON) only one of them will grant forward or reverse rotation command. ⇒ [AA111]  Changing the states of these terminals, switch to the specified frequency references. ⇒[Ab110] to [Ab-25], [Ab210]
002	RV	Reverse rotation	
003	CF1	Multi-speed selection 1	
004	CF2	Multi-speed selection 2	
005	CF3	Multi-speed selection 3	
006	CF4	Multi-speed selection 4	
007	SF1	Multi-speed Bit-1	
008	SF2	Multi-speed Bit-2	
009	SF3	Multi-speed Bit-3	
010	SF4	Multi-speed Bit-4	
011	SF5	Multi-speed Bit-5	
012	SF6	Multi-speed Bit-6	
013	SF7	Multi-speed Bit-7	
014	ADD	Trigger for frequency addition	
015	SCHG	Main/Sub speed reference change	Main speed(OFF)/Sub-speed (ON), to change between them use ⇒[AA105]
016	STA	3-wire start	[STA]'s ON starts the motor. [STP]'s OFF stops the motor.
017	STP	3-wire stop	The inverter forwards operation direction if [F/R] is (OFF), and reverses operation direction if it is (ON). ⇒[AA111]
018	F/R	3-wire forward/reverse	
019	AHD	Analog command holding	When the main speed input source selection [AA101] is the analog input 01 to 06, if AHD terminal is in ON state, holds the Analog terminal value.⇒[AA101]
020	FUP	Remote control speed-UP function	If the frequency reference can be set ([AHD] ON included),[FUP] ON accelerates, and [FDN] ON decelerates. [UDC] returns to the saved value. ⇒[CA-60] to [CA-66]
021	FDN	Remote control speed-DOWN function	
022	UDC	Remote control Speed data clearing	
023	F-OP	Force operation	
024	SET	2nd-motor control	Change between 1st-motor (OFF) and 2nd-motor (ON). ⇒See "4.4 Parameter naming (Nomenclature)"
028	RS	Reset	Reset trip⇒[bb-41], [CA-72]
029	JG	Jogging	Activates Jogging operation. ⇒[AG-20],[AG-21]
030	DB	External dynamic brake	Enables the DC braking operation ⇒[AF101] to [AF109]
031	2CH	2-stage Accel/Decel time	[2CH]'s ON changes the Accel/Decel time. ⇒[AC115]
032	FRS	Free run stop	[FRS]'s ON allows the motor to free run. ⇒[AA115],[bb-40]
033	EXT	External fault	[EXT]'s ON occurs error E012.
034	USP	Unattended start protection	By turning on the power supply while the RUN command is input, the inverter is prevented from starting suddenly. Example) With [USP] = ON, When the power supply is turned on at the RUN command [FW] is ON, the [E013] error is occurred.
035	CS	Commercial power supply change	[CS] is used when switching to commercial power. When [CS] is turned ON, the inverter output is cut off.
036	SFT	Soft-Lock	[SFT]'s ON prevents parameters from being changed.⇒[UA-16]

## [Input terminal function list]

Function code	Symbol	Function name	Description
037	BOK	Answer back from Brake	The brake confirmation signal is inputted for the brake control.
038	OLR	Overload restriction selection	Switches between Overload limit 1(OFF) and 2(ON). ⇒[bA122] to [bA128]
039	KHC	Accumulation input power clearance	[KHC]'s ON clears the Accumulated input power monitor. ⇒[UA-12]
040	OKHC	Accumulation output power clearance	[OKHC]'s ON clears the Accumulated output power monitor. ⇒[UA-14]
041	PID	Disable PID1	[PID]'s ON disables PID1 and the PID1 set-point is used as frequency reference. ⇒[AH-01]
042	PIDC	PID1 integration reset	If ON, clears the integral value of the PID1 control. ⇒[AH-62],[AH-65]
043	PID2	Disable PID2	[PID2]'s ON disables PID2 and the PID2 set-point is used as frequency reference.⇒[AJ-01]
044	PIDC2	PID2 integration reset	If ON, clears the integral value of the PID2 control. ⇒[AJ-14]
045	PID3	Disable PID3	[PID3]'s ON disables PID3 and the PID3 set-point is used as frequency reference. ⇒[AJ-21]
046	PIDC3	PID3 integration reset	If ON, clears the integral value of the PID3 control. ⇒[AJ-34]
047	PID4	Disable PID4	[PID4]'s ON disables PID4 and the PID4 set-point is used as frequency reference.⇒[AJ-41]
048	PIDC4	PID4 integration reset	If ON, clears the integral value of the PID4 control. ⇒[AJ-54]
051	SVC1	Multi set-point selection 1	The target value can be selected by changing the pattern of ON/OFF states. ⇒[AH-06]
052	SVC2	Multi set-point selection 2	
053	SVC3	Multi set-point selection 3	
054	SVC4	Multi set-point selection 4	
055	PRO	PID gain change	Switches between Gain 1(OFF) and Gain 2(ON).
056	PIO1	PID output switching 1	[PIO1] and [PIO2] to select which of PID1 to PID4 will be used for PID output.
057	PIO2	PID output switching 2	PID1 Enable(OFF:OFF) PID2 Enable(OFF:ON) PID3 Enable(ON:OFF) PID4 Enable(ON:ON)
058	SLEP	SLEEP condition activation	In case of [SLEP] terminal selected as sleep trigger, [SLEP]'s ON activates the sleep function. ⇒[AH-85]
059	WAKE	WAKE condition activation	In case of [WAKE] terminal selected as wake trigger, [WAKE]'s ON activates the wake function. ⇒[AH-93]
060	TL	Torque limit enable *1)	[TL]'s ON enables torque limit.
061	TRQ1	Torque limit selection bit 1 *1)	The target value can be selected by changing the pattern of the input terminals ON/OFF states. ⇒[bA111] to [bA115]
062	TRQ2	Torque limit selection bit 2 *1)	

\*1) These functions are disabled when the Control mode selection [AA121/AA221] setting is 00 to 07 (V/f control mode).

## [Input terminal function list]

Function code	Symbol	Function name	Description
063	PPI	P/PI control mode selection	For drooping control, [PPI] switches between PI control (OFF) and P control (ON).
064	CAS	Control gain change	Changes between the PI gain 1 (OFF) and 2(ON) of the speed control system.
065	SON	Servo-on	[SON]'s ON executes the Servo-Lock operation.
066	FOC	Forcing (Pre-excitation)	By turning ON this terminal before operation, the rise of torque is accelerated by applying the exciting current in advance.
067	ATR	Permission of torque control	[ATR]'s ON enables the torque control.
068	TBS	Torque bias enable	[TBS]'s ON enables the torque bias.
069	ORT	Home search function	[ORT]'s ON execute the home position return function in pulse train position control.
071	LAC	Acceleration/Deceleration(LAD) cancellation	[LAC]'s ON forces Accel/Decel time to 0.00s.
072	PCLR	Clearance of position deviation	Clears the position deviation of position control mode.
073	STAT	Pulse train position reference input enable	In the pulse train position control, if [STAT] is ON, the pulse train input is enabled.
074	PUP	Position bias (ADD)	In pulse train position control, when [PUP]/[PDN] is turned on, "Position bias setting[AE-08]" is added/subtracted to/from the position reference.
075	PDN	Position bias (SUB)	
076	CP1	Multistage position settings selection 1	The position reference can be selected by changing the pattern of ON/OFF states.
077	CP2	Multistage position settings selection 2	
078	CP3	Multistage position settings selection 3	
079	CP4	Multistage position settings selection 4	
080	ORL	Limit signal of homing function	Used by the Zero-Return position operations of the position control.
081	ORG	Start signal of homing function	
082	FOT	Forward over travel	When this signal is ON, the forward drive in absolute position control mode is limited (The torque limit value in the forward direction is set to 10%).
083	ROT	Reverse over travel	When this signal is ON, reverse drive in absolute position control mode is limited (Torque limit value in reverse direction is set to 10%).
084	SPD	Speed/Position switching	Switches position control (OFF) and speed control (ON).

## [Input terminal function list]

Function code	Symbol	Function name	Description
085	PSET	Position data presetting	[PSET]'s ON sets the actual position to the Pre-set position [AE-62].
086	MI1	General-purpose input 1	When these functions are assigned, they become general purpose input signals of the EzSQ function.
087	MI2	General-purpose input 2	
088	MI3	General-purpose input 3	
089	MI4	General-purpose input 4	
090	MI5	General-purpose input 5	
091	MI6	General-purpose input 6	
092	MI7	General-purpose input 7	
093	MI8	General-purpose input 8	
094	MI9	General-purpose input 9	
095	MI10	General-purpose input 10	
096	MI11	General-purpose input 11	
097	PCC	Pulse counter clearing	[PCC]'s ON clears the count for the pulse counter function.
098	ECOM	EzCOM activation	[ECOM]'s ON activates EzCOM.
099	PRG	Program RUN	[PRG]'s ON executes EzSQ.
100	HLD	Acceleration/Deceleration disable	[HLD]'s ON temporarily stops Accel/Decel operation.
101	REN	RUN enable	Run command is not possible when the input terminal function [REN] is assigned and it is OFF.
102	DISP	Display lock	[DISP]'s ON locks the keypad screen.
103	PLA	Pulse count A	For pulse train input use.
104	PLB	Pulse count B	For pulse train input use.
105	EMF	Emergency-force drive activation	Forces the set operation in emergency state.
107	COK	Contact check signal	Regarding the braking control, check signal for the contactor.
108	DTR	Data trace start	[DTR]'s ON starts data trace function.
109	PLZ	Pulse train input Z	Z phase pulse input of the external encoder. It is invalid when using P1-FB.
110	TCH	Teach-in signal	[TCH]'s ON starts teach-in function.

\*1) LAD :Lead to acceleration and deceleration

[CA-60] to [CA-84]

[CA-90] to [CA-99]

[FUP] / [FDN] operations

Code/Name	Range (unit)	Initial value
<b>CA-60</b> FUP/FDN overwrite target selection	00(Speed reference) 01(PID1 Set point)	00
<b>CA-61</b> FUP/FDN data save enable	00(No save)/ 01(Save)	00
<b>CA-62</b> FUP/FDN UDC selection	00(OHz)/ 01(Saved data)	00
<b>CA-64</b> Acceleration time setting for FUP/FDN function	0.00 to 3600.00(s)	30.00
<b>CA-66</b> Deceleration time setting for FUP/FDN function		30.00

- [CA-60] sets as operation target the frequency reference or the PID target value for 020[FUP]/021[FDN].
- [CA-61] sets whether the modified values of [FUP] / [FDN] should be saved or not in the inverter non-volatile memory.
- [CA-62] selects the frequency reference when input terminal 022[UDC] is ON.
- If [FUP]/[FDN] is turn ON, in the case the frequency reference is changed you can set the acceleration and deceleration time [CA-64][CA-66].

[F-OP] Speed/Operation change

Code/Name	Range (unit)	Initial value
<b>CA-70</b> Speed reference source selection when [F-OP] is active	01(Terminal[Ai1])/02(Terminal[Ai2])/03(Terminal[Ai3])/04(Terminal[Ai4])/05(Terminal[Ai5])/06(Terminal[Ai1])/07(Parameter Setting)/08(RS485)/09(Option-1)/10(Option-2)/11(Option-3)/12(Pulse train input(internal))/13(Pulse train input(option))/14(Program function)/15(PID calc.)/16(MOP VR)	01
<b>CA-71</b> RUN command source selection when [F-OP] is active	00([FW]/[RV] terminal)/01(3-wire)/02(Keypad's RUN key)/03(RS485)/04(Option-1)/05(Option-2)/06(Option-3)	00

- If input terminal 023[F-OP] is ON, the above settings are carried out.

Reset terminal [RS]

Code/Name	Range (unit)	Initial value
<b>CA-72</b> Reset mode selection	00(Always enabled (Trip release at turn-ON))/01(Always enabled (Trip release at turn-OFF))/02(Only enable in trip status (Trip release at turn-ON))/03(Only enable in trip status (Trip release at turn-OFF))	00

- Normally, frequency, terminals and etc. outputs are OFF when reset terminal is ON. It is also possible to enable only trip reset.

Main encoder input (For input terminals [A]/[B])

Code/Name	Range (unit)	Initial value
<b>CA-81</b> Encoder constant setting	32 to 65535(pulse)	1024
<b>CA-82</b> Encoder phase sequence selection	00(Phase-A Lead)/01(Phase-B Lead)	00
<b>CA-83</b> Motor gear ratio numerator	1 to 10000	1
<b>CA-84</b> Motor gear ratio denominator	1 to 10000	1

- Above parameters set the motor gear ratio involved in the encoder feedback to input terminal [A]/[B].

Pulse train input terminal[A][B]

Code/Name	Range (unit)	Initial value
<b>CA-90</b> Pulse train input, target function selection	00(Disable)/01(Reference)/02(Speed feedback)/03(Pulse count)	00
<b>CA-91</b> Pulse train input mode selection	00(90 degrees shift pulse train)/01(Forward/Reverse pulse train and direction signal)/02(Forward pulse train and reverse pulse train)	00
<b>CA-92</b> Pulse train frequency scale	0.05 to 32.00(kHz)	25.00
<b>CA-93</b> Pulse train frequency filter time constant	0.01 to 2.00(s)	0.10
<b>CA-94</b> Pulse train frequency bias value	-100.0 to 100.0(%)	0.0
<b>CA-95</b> Pulse train upper frequency detection level	0.0 to 100.0(%)	100.0
<b>CA-96</b> Pulse train lower frequency detection level	0.0 to 100.0(%)	0.0

- When [CA-90] is other than 00, the input terminals [A]/[B] become pulse train input terminals. Assign the input terminal function 103[PLA]/104[PLB] to terminals [A]/[B] to perform pulse train input frequency reference, vector control with encoder feedback or absolute position control. The pulse train count method follows the setting of [CA-91].

Pulse train input counter

Code/Name	Range (unit)	Initial value
<b>CA-97</b> Pulse counter compare match output ON value	0 to 65535	0
<b>CA-98</b> Pulse counter compare match output OFF value	0 to 65535	0
<b>CA-99</b> Pulse counter maximum value	0 to 65535	65535

- Set 044[PCMP] to output the compare results of the pulse train counters of functions 103[PLA]/104[PLB].
- Turning 097[PCC] terminal in ON state resets the counter.

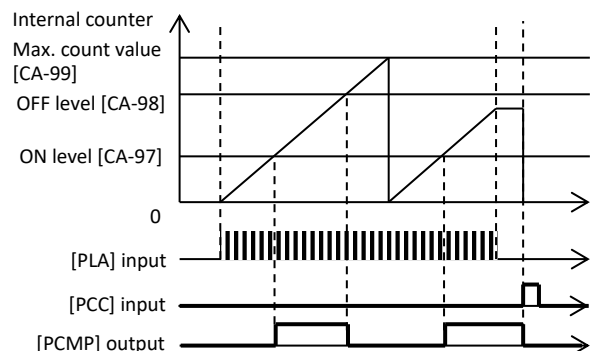

**[Cb-01] to [Cb-35]****Analog input adjustment**

Code/Name	Range (unit)	Initial value
<b>Cb-01</b> [Ai1] Filter time constant	1 to 500(ms)	16
<b>Cb-03</b> [Ai1] Start value	0.00 to 100.00(%)	0.00
<b>Cb-04</b> [Ai1] End value	0.00 to 100.00(%)	100.00
<b>Cb-05</b> [Ai1] Start rate	0.0 to [Cb-06](%)	0.0
<b>Cb-06</b> [Ai1] End rate	[Cb-05] to 100.0(%)	100.0
<b>Cb-07</b> [Ai1] Start value selection	00(Start value)/ 01(0%)	01
<b>Cb-11</b> [Ai2] Filter time constant	1 to 500(ms)	16
<b>Cb-13</b> [Ai2] Start value	0.00 to 100.00(%)	0.00
<b>Cb-14</b> [Ai2] End value	0.00 to 100.00(%)	100.00
<b>Cb-15</b> [Ai2] Start rate	0.0 to [Cb-16](%)	20.0
<b>Cb-16</b> [Ai2] End rate	[Cb-15] to 100.0(%)	100.0
<b>Cb-17</b> [Ai2] Start value selection	00(Start value)/ 01(0%)	01
<b>Cb-21</b> [Ai3] Filter time constant	1 to 500(ms)	16
<b>Cb-22</b> Terminal [Ai3] selection	00(Single)/ 01(Added to Ai1/Ai2: forward and reverse) 02(Added to Ai1/Ai2: Forward only)	00
<b>Cb-23</b> [Ai3] Start value	-100.00 to 100.00(%)	-100.00
<b>Cb-24</b> [Ai3] End value	-100.00 to 100.00(%)	100.00
<b>Cb-25</b> [Ai3] Start rate	-100.0 to [Cb-26]	-100.0
<b>Cb-26</b> [Ai3] End rate	[Cb-25] to 100.0	100.0
<b>Cb-30</b> [Ai1] Voltage/Current bias adjustment	-100.00 to 100.00(%)	0.00
<b>Cb-31</b> [Ai1] Voltage/Current gain adjustment	0.00 to 200.00(%)	100.00
<b>Cb-32</b> [Ai2] Voltage/Current bias adjustment	-100.00 to 100.00(%)	0.00
<b>Cb-33</b> [Ai2] Voltage/Current gain adjustment	0.00 to 200.00(%)	100.00
<b>Cb-34</b> [Ai3] Voltage bias adjustment	-100.00 to 100.00(%)	0.00
<b>Cb-35</b> [Ai3] Voltage gain adjustment	0.00 to 200.00(%)	100.00

- Regarding the adjustment method of the Analog input, refer to the section “3.9 Adjust the analog input (Ai1/Ai2)” and section “3.11 Adjust the analog input (Ai3)”.

**[Cb-40] to [Cb-57][CC-01] to [CC-17]****Thermistor error detection**

Code/Name	Range (unit)	Initial value
<b>Cb-40</b> Thermistor type selection	00(Disable)/ 01(PTC)/02(NTC)	00
<b>Cb-41</b> Thermistor gain adjustment	0.0 to 1000.0	100.0

- Set [Cb-40] according to the connected thermistor in TH input terminal.
- When [CA-40]=01 or 02, set [bb-70] the error level. Refer to [bb-70].
- In [Cb-41] thermistor gain adjustment, when the adjustment value is raised the resistance value is lowered.

**MOP volume input adjustment**

Code/Name	Range (unit)	Initial value
<b>Cb-51</b> MOP-VR input filter time constant	1 to 500	100
<b>Cb-53</b> MOP-VR start value	0.00 to 100.00(%)	0.00
<b>Cb-54</b> MOP-VR end value	0.00 to 100.00(%)	100.00
<b>Cb-55</b> MOP-VR start ratio	0.0 to [Cb-56](%)	0.0
<b>Cb-56</b> MOP-VR end ratio	[Cb-55] to 100.0(%)	100.0
<b>Cb-57</b> MOP-VR start selection	00(Start value)/ 01(0%)	01

- These are the parameters when using optional operation keypad (MOP).

**Intelligent Output terminals setting**

Code/Name	Range (unit)	Initial value
<b>CC-01</b> Output terminal [11] function	Reference <Intelligent output terminal function list>	001(RUN)
<b>CC-02</b> Output terminal [12] function		002(FA1)
<b>CC-03</b> Output terminal [13] function		003(FA2)
<b>CC-04</b> Output terminal [14] function		007(IRDY)
<b>CC-05</b> Output terminal [15] function		035(OL)
<b>CC-06</b> Output terminal [16] function		000(NO)*1)
<b>CC-07</b> Output terminal [AL] function		017(AL)

\*1) In Ver2.01 and older, initial value is 040[ZS].

- The functions for the output terminals 11 to 15,16A,AL are assigned in [CC-01] to [CC-05],[CC-06],[CC-07].

**Output terminal NO/NC setting**

Code/Name	Range (unit)	Initial value
<b>CC-11</b> Output terminal [11] active state	00(Normally open: NO)/ 01(Normally closed: NC)	00
<b>CC-12</b> Output terminal [12] active state		00
<b>CC-13</b> Output terminal [13] active state		00
<b>CC-14</b> Output terminal [14] active state		00
<b>CC-15</b> Output terminal [15] active state		00
<b>CC-16</b> Output terminal [16] active state		00
<b>CC-17</b> Output terminal [AL] active state		01

- The NO/NC setting for the Intelligent output terminals 11 to 15,16A,AL are assigned in [CC-11] to [CC-15], [CC-16], [CC-17].

## [CC-20] to [CC-33]

## Output terminals stabilization

Code/Name	Range (unit)	Initial value
<b>CC-20</b> Output terminal [11] on-delay time	0.00 to 100.00(s)	0.00
<b>CC-21</b> Output terminal [11] off-delay time	0.00 to 100.00(s)	0.00
<b>CC-22</b> Output terminal [12] on-delay time	0.00 to 100.00(s)	0.00
<b>CC-23</b> Output terminal [12] off-delay time	0.00 to 100.00(s)	0.00
<b>CC-24</b> Output terminal [13] on-delay time	0.00 to 100.00(s)	0.00
<b>CC-25</b> Output terminal [13] off-delay time	0.00 to 100.00(s)	0.00
<b>CC-26</b> Output terminal [14] on-delay time	0.00 to 100.00(s)	0.00
<b>CC-27</b> Output terminal [14] off-delay time	0.00 to 100.00(s)	0.00
<b>CC-28</b> Output terminal [15] on-delay time	0.00 to 100.00(s)	0.00
<b>CC-29</b> Output terminal [15] off-delay time	0.00 to 100.00(s)	0.00
<b>CC-30</b> Output terminal [16] on-delay time	0.00 to 100.00(s)	0.00
<b>CC-31</b> Output terminal [16] off-delay time	0.00 to 100.00(s)	0.00
<b>CC-32</b> Output terminal [AL] on-delay time	0.00 to 100.00(s)	0.00
<b>CC-33</b> Output terminal [AL] off-delay time	0.00 to 100.00(s)	0.00

- The above parameters set the delay time from the change of the output terminal to the actual response.

## [output terminal function list]

Function code	Symbol	Function name	Description
000	No	Not use	-
001	RUN	Running	ON while output is active
002	FA1	Constant-frequency reached	Turns ON when the output frequency reaches and same as frequency reference and stable.
003	FA2	Set frequency overreached	Turns ON when the output frequency exceeds the specified arrival value. [CE-10][CE-11]
004	FA3	Set frequency reached	Turns ON when the output frequency is the same (within the fixed narrow range) as the set value. [CE-10][CE-11]
005	FA4	Set frequency overreached 2	Same as FA2. The setting is based on [CE-12] [CE-13].
006	FA5	Set frequency reached 2	Same as FA3. The setting is based on [CE-12] [CE-13].
007	IRDY	Inverter ready	ON when inverter is ready
008	FWR	Forward rotation	ON while in forward drive
009	RVR	Reverse rotation	ON while in reverse drive
010	FREF	Frequency reference = Keypad is selected	ON if the frequency reference is from keypad
011	REF	Run command = Keypad is selected	ON if the RUN command is from keypad.
012	SETM	2nd control is selected	ON if 2nd-motor selected
016	OPO	Option output	(For future. Do not assign.)
017	AL	Alarm	ON when trip happens
018	MJA	Major failure	ON if major failure trips
019	OTQ	Over-torque *1)	ON if torque exceeds the level [CE120] to [CE123].
020	IP	Instantaneous power failure	After the main power supply R,S,T is established, it turns ON when an instantaneous power failure of the main power supply is detected.
021	UV	Under-voltage	Turns on when main power drops or control power fails.
022	TRQ	Torque limited	ON if torque limit operates
023	IPS	IP-Non stop function is active	ON if IP-Non stop function operates in power loss.
024	RNT	Accumulated operation time over	ON if set time [CE-36] is exceeded
025	ONT	Accumulated power-on time over	ON if set time [CE-36] is exceeded
026	THM	Electronic thermal alarm signal(MTR)	ON if motor thermal integral value exceeds set value [CE-30]
027	THC	Electronic thermal alarm signal(CTL)	ON if inverter thermal integral value exceeds set value [CE-31]
029	WAC	Capacitor life warning	ON by life warning
030	WAF	Cooling-fan speed drop	ON by life warning
031	FR	RUN command active	ON while in operation
032	OHF	Heat sink overheat warning	ON when the heatsink temperature is over the setting value [CE-34].
033	LOC	Low-current indication signal	ON if output current is less than the setting value [CE102].

\*1) This function is disabled when the Control mode selection [AA121/AA221] setting is 00 to 07 (V/f control mode).

[Output terminal function list]

Function code	Symbol	Function name	Description
034	LOC2	Low-current indication signal 2	ON if output current is less than the setting value [CE103].
035	OL	Overload notice advance signal 1	ON if output current exceeds specified value [CE106].
036	OL2	Overload notice advance signal 2	ON if output current exceeds specified value [CE107].
037	BRK	Brake release	ON when brake releases.
038	BER	Brake error	ON if abnormality happens in brake control sequence.
039	CON	Contacting control	This signal is used for power line contactor control.
040	ZS	Zero speed detection	ON if output frequency is less than set value [CE-33].
041	DSE	Speed deviation over	ON if speed deviation exceeds the set value. [bb-82] [bb-83] [bb-84].
042	PDD	Position deviation over	ON if position deviation exceeds the set value. [bb-85] [bb-86] [bb-87]
043	POK	Positioning completed	ON if positioning is completed.
044	PCMP	Pulse count compare match output	ON when set value and pulse train counter match. [CA-97] to [CA-99]
045	OD	Deviation over for PID control	ON if PID1 control deviation exceeds the set value [AH-72].
046	FBV	PID1 feedback comparison	ON if PID1 feedback is within range. [AH-73] [AH-74]
047	OD2	OD: Deviation over for PID2 control	ON if PID2 control deviation exceeds the set value [AJ-17].
048	FBV2	PID2 feedback comparison	ON if PID2 feedback is within range. [AJ-18] [AJ-19]
049	NDc	Communication line disconnection	ON if disconnection of RS485 communication is detected.
050	Ai1Dc	Analog [Ai1] disconnection detection	Turns ON/OFF depending on the window comparator setting conditions for analog input Ai1.
051	Ai2Dc	Analog [Ai2] disconnection detection	Turns ON/OFF depending on the window comparator setting conditions for analog input Ai2.
052	Ai3Dc	Analog [Ai3] disconnection detection	Turns ON/OFF depending on the window comparator setting conditions for analog input Ai3.
053	Ai4Dc	Analog [Ai4] disconnection detection	Turns ON/OFF depending on the window comparator setting conditions for analog input Ai4.
054	Ai5Dc	Analog [Ai5] disconnection detection	Turns ON/OFF depending on the window comparator setting conditions for analog input Ai5.
055	Ai6Dc	Analog [Ai6] disconnection detection	Turns ON/OFF depending on the window comparator setting conditions for analog input Ai6.
056	WCAi1	Window comparator Ai1	ON if Analog input 1 is within range. [CE-40] to [CE-42]
057	WCAi2	Window comparator Ai2	ON if Analog input 2 is within range. [CE-43] to [CE-45]
058	WCAi3	Window comparator Ai3	ON if Analog input 3 is within range. [CE-46] to [CE-48]
059	WCAi4	Window comparator Ai4	ON if Analog input 4 is within range. [oE-35] to [oE-37]
060	WCAi5	Window comparator Ai5	ON if Analog input 5 is within range. [oE-38] to [oE-40]
061	WCAi6	Window comparator Ai6	ON if Analog input 6 is within range. [oE-41] to [oE-43]

[Output terminal function list]

Function code	Symbol	Function name	Description
062	LOG1	Logical operation result 1	Determined by the calculation results of two output terminals.
063	LOG2	Logical operation result 2	
064	LOG3	Logical operation result 3	
065	LOG4	Logical operation result 4	
066	LOG5	Logical operation result 5	
067	LOG6	Logical operation result 6	
068	LOG7	Logical operation result 7	
069	MO1	General-purpose output 1	For EzSQ program.
070	MO2	General-purpose output 2	
071	MO3	General-purpose output 3	
072	MO4	General-purpose output 4	
073	MO5	General-purpose output 5	
074	MO6	General-purpose output 6	
075	MO7	General-purpose output 7	
076	EMFC	Emergency force drive indicator	ON while in force operation
077	EMBP	Bypass mode indicator	ON while in bypass operation
078	WFT	Trace function waiting for trigger	This signal turns on until the trace start triggers are input.
079	TRA	Trace function data logging	ON while in data sampling.
080	LBK	Low-battery of keypad	ON while in low battery or when keypad transfers no clock data.
081	OVS	Overvoltage power Supply	ON when overvoltage is detected in stop status.
084	AC0	Alarm code bit-0	Alarm information is output as bits by these signals. Refer to the P1 User Guide for more details.
085	AC1	Alarm code bit-1	
086	AC2	Alarm code bit-2	
087	AC3	Alarm code bit-3	
089	OD3	Deviation over for PID3 control	ON when PID3 deviation exceeds the value [AJ-37]
090	FBV3	PID3 feedback comparison	ON when PID3 feedback is between [AJ-38]/[AJ-39]
091	OD4	Deviation over for PID4 control	ON when PID4 deviation exceeds the value [AJ-57]
092	FBV4	PID4 feedback comparison	ON when PID4 feedback is between [AJ-58]/[AJ-59]
093	SSE	PID soft start error	ON when PID soft start became in warning status

## [CC-40] to [CC-60]

## Logic output terminals setting

Code/Name	Range (unit)	Initial value
<b>CC-40</b> LOG1 operand-1 selection	<Intelligent output terminal function list> reference *1)	000
<b>CC-41</b> LOG1 operand-2 selection	<Intelligent output terminal function list> reference *1)	000
<b>CC-42</b> LOG1 logical calculation selection	00(AND)/01(OR)/02(XOR)	00
<b>CC-43</b> LOG2 operand-1 selection	<Intelligent output terminal function list> reference *1)	000
<b>CC-44</b> LOG2 operand-2 selection	<Intelligent output terminal function list> reference *1)	000
<b>CC-45</b> LOG2 logical calculation selection	00(AND)/01(OR)/02(XOR)	00
<b>CC-46</b> LOG3 operand-1 selection	<Intelligent output terminal function list> reference *1)	000
<b>CC-47</b> LOG3 operand-2 selection	<Intelligent output terminal function list> reference *1)	000
<b>CC-48</b> LOG3 logical calculation selection	00(AND)/01(OR)/02(XOR)	00
<b>CC-49</b> LOG4 operand-1 selection	<Intelligent output terminal function list> reference *1)	000
<b>CC-50</b> LOG4 operand-2 selection	<Intelligent output terminal function list> reference *1)	000
<b>CC-51</b> LOG4 logical calculation selection	00(AND)/01(OR)/02(XOR)	00
<b>CC-52</b> LOG5 operand-1 selection	<Intelligent output terminal function list> reference *1)	000
<b>CC-53</b> LOG5 operand-2 selection	<Intelligent output terminal function list> reference *1)	000
<b>CC-54</b> LOG5 logical calculation selection	00(AND)/01(OR)/02(XOR)	00
<b>CC-55</b> LOG6 operand-1 selection	<Intelligent output terminal function list> reference *1)	000
<b>CC-56</b> LOG6 operand-2 selection	<Intelligent output terminal function list> reference *1)	000
<b>CC-57</b> LOG6 logical calculation selection	00(AND)/01(OR)/02(XOR)	00
<b>CC-58</b> LOG7 operand-1 selection	<Intelligent output terminal function list> reference *1)	000
<b>CC-59</b> LOG7 operand-2 selection	<Intelligent output terminal function list> reference *1)	000
<b>CC-60</b> LOG7 logical calculation selection	00(AND)/01(OR)/02(XOR)	00

\*1) 062[LOG1] to 068[LOG7] can not be selected.

- The logical operation function outputs the operation results of the two selected output functions to the output terminal functions [LOG1] to [LOG7].

## [Cd-01] to [Cd-35]

## Analog output terminal adjustment

Code/Name	Range (unit)	Initial value
<b>Cd-01</b> [FM] Output wave form selection	00(PWM)/01(Frequency)	00
<b>Cd-02</b> [FM] Output base frequency (At digital frequency output)	0 to 3600(Hz)	2880
<b>Cd-03</b> [FM] Output monitor selection	(Select from d*-, F*-* parameters)	dA-01
<b>Cd-04</b> [Ao1] Output monitor selection		dA-01
<b>Cd-05</b> [Ao2] Output monitor selection		dA-01
<b>Cd-10</b> Analog monitor adjustment mode enable	00(Disable)/01(Enable)	00
<b>Cd-11</b> [FM] Output filter time constant	1 to 500(ms)	100
<b>Cd-12</b> [FM] Data type selection	00(Absolute value)/01(Signed value)	00
<b>Cd-13</b> [FM] Bias adjustment	-100.0 to 100.0(%)	0.0
<b>Cd-14</b> [FM] Gain adjustment	-1000.0 to 1000.0(%)	100.0
<b>Cd-15</b> Adjustment mode [FM] output level	-100.0 to 100.0(%)	100.0
<b>Cd-21</b> [Ao1] Output filter time constant	1 to 500(ms)	100
<b>Cd-22</b> [Ao1] Data type selection	00(Absolute value)/01(Signed value)	00
<b>Cd-23</b> [Ao1] Bias adjustment	-100.0 to 100.0(%)	0.0
<b>Cd-24</b> [Ao1] Gain adjustment	-1000.0 to 1000.0(%)	100.0
<b>Cd-25</b> Adjustment mode [Ao1] output level	-100.0 to 100.0(%)	100.0
<b>Cd-31</b> [Ao2] Output filter time constant	1 to 500(ms)	100
<b>Cd-32</b> [Ao2] Data type selection	00(Absolute value)/01(Signed value)	00
<b>Cd-33</b> [Ao2] Bias adjustment	-100.0 to 100.0(%)	20.0
<b>Cd-34</b> [Ao2] Gain adjustment	-1000.0 to 1000.0(%)	80.0 *2)
<b>Cd-35</b> Adjustment mode [Ao2] output level	-100.0 to 100.0(%)	100.0

\*2) In Ver2.01 and older, initial value is 100.0%

- Regarding the adjustment method of the Analog output, refer to the "chapter 3.10 Adjust the analog output (Ao1/Ao2/FM)"



[CE101] to [CE107]

Low-current detection signal

Code/Name	Range (unit)	Initial value
<b>CE101</b> Low current signal output mode selection, 1st motor	00(During Accel/Decel and constant speed) 01(During constant speed only)	01
<b>CE102</b> Low current detection level 1, 1st motor	Inverter rated current×(0.00 to 2.00)(A)	Inverter rated current ×1.00(A)
<b>CE103</b> Low current detection level 2, 1st motor	Inverter rated current×(0.00 to 2.00)(A)	Inverter rated current ×1.00(A)

- When the output current is lower than the set value, output terminal 033[LOC]/034[LOC2] Low-current indication signal 1/2 Outputs low current signal.

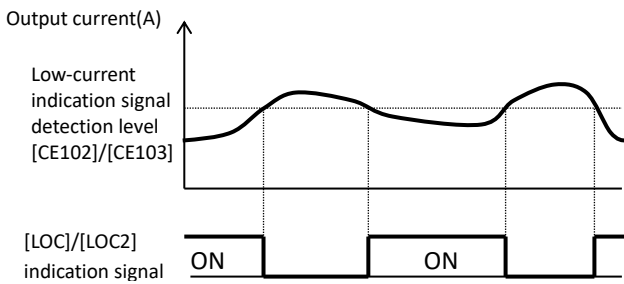

Overload detection signal

Code/Name	Range (unit)	Initial value
<b>CE105</b> Overload signal output mode selection, 1st motor	00(During Accel/Decel and constant speed)/ 01(During constant speed only)	01
<b>CE106</b> Overload warning level 1, 1st motor	Inverter rated current×(0.00 to 2.00)(A)	Inverter rated current ×1.00(A)
<b>CE107</b> Overload warning level 2, 1st motor	Inverter rated current×(0.00 to 2.00)(A)	Inverter rated current ×1.00(A)

- When overload occurs, Output terminal 035[OL]/036[OL2] overload notice advance signals are output.

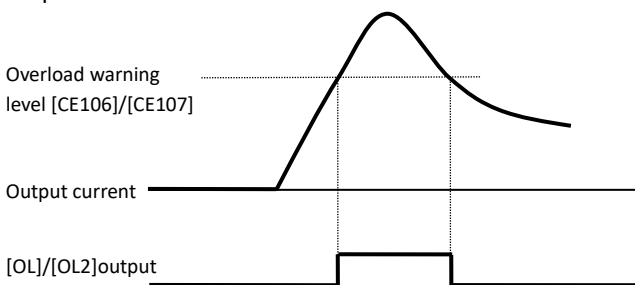

[CE-10] to [CE-31]

Frequency arrival signal setting

Code/Name	Range (unit)	Initial value
<b>CE-10</b> Arrival frequency 1 value setting during acceleration	0.00 to 590.00(Hz)	0.00
<b>CE-11</b> Arrival frequency 1 value setting during deceleration		0.00
<b>CE-12</b> Arrival frequency 2 value setting during acceleration		0.00
<b>CE-13</b> Arrival frequency 2 value setting during deceleration		0.00

- Above parameters set the operation of the frequency arrival signal.

(Example) In 003[FA2]/005[FA4] case:

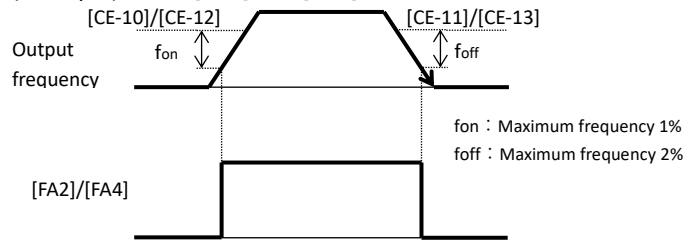

(Example) In 004[FA3]/006[FA5] case:

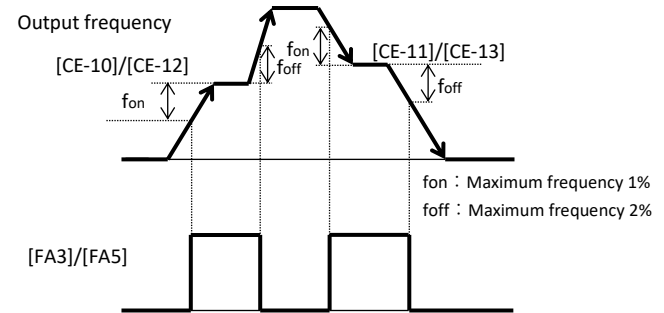

Over-torque signal

Code/Name	Range (unit)	Initial value
<b>CE120</b> Over-torque level (Forward drive), 1st motor	0.0 to 500.0(%)	100.0
<b>CE121</b> Over-torque level (Reverse regenerative), 1st motor		100.0
<b>CE122</b> Over-torque level (Reverse drive), 1st motor		100.0
<b>CE123</b> Over-torque level (Forward regenerative), 1st motor		100.0

- Set the level to output the 019[OTQ] signal, when using vector control and the torque goes over the limit.

Electronic thermal warning

Code/Name	Range (unit)	Initial value
<b>CE-30</b> Electronic thermal warning level (MTR)	0.00 to 100.00(%)	80.00
<b>CE-31</b> Electronic thermal warning level (CTL)		80.00

- [CE-30] sets the level to output the motor electronic thermal warning 026[THM].
- [CE-31] sets the level to output the inverter electronic thermal warning 027[THC].

[CE-33] to [CE-51]

0Hz speed detection signal

Code/Name	Range (unit)	Initial value
<b>CE-33</b> Zero speed detection level	0.00 to 100.00(Hz)	0.50

- Set the level in which the output terminal 040[ZS] Zero speed detection turns ON.

Cooling fin overheat warning signal

Code/Name	Range (unit)	Initial value
<b>CE-34</b> Cooling fin overheat warning level	0 to 200(°C)	120

- Set the level in which output terminal 032[OHF]Heat sink overheat warning turns ON.

Accumulated RUN time / Accumulated PowerON time warning

Code/Name	Range (unit)	Initial value
<b>CE-36</b> Accum. RUN time (RNT) / Accum. Power-On time (ONT) setting	0 to 100000(hr)	0

- Set the warning level in which the output terminal 024[RNT] accumulated operation time over and output terminal 025[ONT] accumulated power-on time over turn ON.

Window comparator (detection of terminal disconnection)

Code/Name	Range (unit)	Initial value
<b>CE-40</b> [Ai1] Window comparator higher limit	0 to 100(%)	100
<b>CE-41</b> [Ai1] Window comparator lower limit	0 to 100(%)	0
<b>CE-42</b> [Ai1] Window comparator hysteresis width	0 to 10(%)	0
<b>CE-43</b> [Ai2] Window comparator higher limit	0 to 100(%)	100
<b>CE-44</b> [Ai2] Window comparator lower limit	0 to 100(%)	0
<b>CE-45</b> [Ai2] Window comparator hysteresis width	0 to 10(%)	0
<b>CE-46</b> [Ai3] Window comparator higher limit	-100 to 100(%)	100
<b>CE-47</b> [Ai3] Window comparator lower limit	-100 to 100(%)	-100
<b>CE-48</b> [Ai3] Window comparator hysteresis width	0 to 10(%)	0
<b>CE-50</b> [Ai1] Operation set level at disconnection or compare event	0 to 100(%)	0
<b>CE-51</b> [Ai1] Operation set level implement timing	00(Disable)/01(Enable(at WC*active)/02(Enable(at WC*de-active)	00

[CE-52] to [CE-55][CE201]to[CE223]

Code/Name	Range (unit)	Initial value
<b>CE-52</b> [Ai2] Operation set level at disconnection or compare event	0 to 100(%)	0
<b>CE-53</b> [Ai2] Operation set level implement timing	00(Disable)/01(Enable (at WC*active)/02(Enable (at WC*de-active)	00
<b>CE-54</b> [Ai3] Operation set level at disconnection or compare event	-100 to 100(%)	0
<b>CE-55</b> [Ai3] Operation set level implement timing	00(Disable)/01(Enable (at WC*active)/02(Enable (at WC*de-active)	00

- Window comparator function output signals whenever the analog inputs value are within or out of range.
- In the case of disconnection judgment, the reference value can be set to the [CE-50]/[CE-52]/[CE-54] setting value when it is within or out of the range of the window comparator.

If in case [CE-51] [CE-53] [CE-55] = 02:

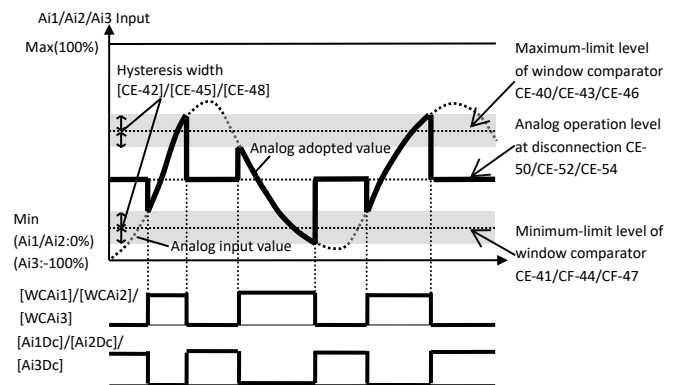

- When using the P1-AG analog input/output option, Output terminal 053[Ai4Dc] to 055[Ai6Dc] and 059 [WCAi4] to 061[WCAi6] can be output in the same operation as the above figure by using parameters [oE-35] to [oE-49].

2nd motor When Intelligent Input terminal 024[SET] is enabled.

Code/Name	Range (unit)	Initial value
<b>CE201</b> Low current signal output mode selection, 2nd-motor	Same as CE101	
<b>CE202</b> Low current detection level 1, 2nd-motor	Same as CE102	
<b>CE203</b> Low current detection level 2, 2nd-motor	Same as CE103	
<b>CE205</b> Overcurrent signal output mode selection, 2nd-motor	Same as CE105	
<b>CE206</b> Overcurrent detection level 1, 2nd-motor	Same as CE106	
<b>CE207</b> Overcurrent detection level 2, 2nd-motor	Same as CE107	
<b>CE220</b> Over-torque level (Forward drive), 2nd-motor	Same as CE120	
<b>CE221</b> Over-torque level (Reverse regenerative), 2nd-motor	Same as CE121	
<b>CE222</b> Over-torque level (Reverse drive), 2nd-motor	Same as CE122	
<b>CE223</b> Over-torque level (Forward regenerative), 2nd motor	Same as CE123	

## [CF-01] to [CF-11]

## Modbus communication

Code/Name	Range (unit)	Initial value
<b>CF-01</b> RS485 communication baud rate selection	03(2400bps)/ 04(4800bps)/ 05(9600bps)/ 06(19.2kbps)/ 07(38.4kbps)/ 08(57.6kbps)/ 09(76.8kbps)/ 10(115.2kbps)	05
<b>CF-02</b> RS485 communication node address	1 to 247	1
<b>CF-03</b> RS485 communication parity selection	00(No parity)/ 01(Even parity)/ 02(Odd parity)	00
<b>CF-04</b> RS485 communication stop bit selection	01(1bit)/02(2bit)	01
<b>CF-05</b> RS485 communication error selection	00(Error)/ 01(Error output after Deceleration stop)/ 02(Ignore)/ 03(Free run stop)/ 04(Deceleration stop)	02
<b>CF-06</b> RS485 communication timeout setting	0.00 to 100.00(s)	0.00
<b>CF-07</b> RS485 communication wait time setting	0 to 1000(ms)	2
<b>CF-08</b> RS485 communication mode selection	01(Modbus-RTU)/ 02(EzCOM)/ 03(EzCOM Administrator)	01
<b>CF-11</b> Register data conversion function (A, V↔%)	00(A, V)/ 01(%)	00

- Set the Modbus communication function for its use.
- When using communication function between inverter EzCOM, set a value except 01 for [CF-08].
- When communication disconnection occurs, the output terminal 049[NDC] turns ON. 049[NDC] signal is turned off when the error is cleared. For more information, refer to the P1 User's guide.

## [CF-20] to [CF-50]

## EzCOM peer to peer communication

Code/Name	Range (unit)	Initial value
<b>CF-20</b> EzCOM start node No.	1 to 8	1
<b>CF-21</b> EzCOM end node No.	1 to 8	1
<b>CF-22</b> EzCOM start method selection	00(Terminal [EzCOM])/ 01(Always)	00
<b>CF-23</b> EzCOM data size	1 to 5	5
<b>CF-24</b> EzCOM destination address 1	1 to 247	1
<b>CF-25</b> EzCOM destination register 1	0000 to FFFF	0000
<b>CF-26</b> EzCOM source register 1	0000 to FFFF	0000
<b>CF-27</b> EzCOM destination address 2	1 to 247	2
<b>CF-28</b> EzCOM destination register 2	0000 to FFFF	0000
<b>CF-29</b> EzCOM source register 2	0000 to FFFF	0000
<b>CF-30</b> EzCOM destination address 3	1 to 247	3
<b>CF-31</b> EzCOM destination register 3	0000 to FFFF	0000
<b>CF-32</b> EzCOM source register 3	0000 to FFFF	0000
<b>CF-33</b> EzCOM destination address 4	1 to 247	4
<b>CF-34</b> EzCOM destination register 4	0000 to FFFF	0000
<b>CF-35</b> EzCOM source register 4	0000 to FFFF	0000
<b>CF-36</b> EzCOM destination address 5	1 to 247	5
<b>CF-37</b> EzCOM destination register 5	0000 to FFFF	0000
<b>CF-38</b> EzCOM source register 5	0000 to FFFF	0000

- Above parameters are set for use the EzCOM function. For more information, refer to the P1 User's guide.

## USB node setting

Code/Name	Range (unit)	Initial value
<b>CF-50</b> USB communication node address	1 to 247	1

- Sets the USB node address in the case of connection with ProDriveNext(PC software). It is also required to confirm the USB node in the ProDriveNext side (The initial value of ProDriveNext is also node address 1).
- When connecting P1 and ProDriveNext at first time, keep the setting value 1 .

[HA-01] to [HA115]

■ Parameter mode (H code)

Auto-tuning

Code/Name	Range (unit)	Initial value
<b>HA-01</b> Auto-tuning selection	00(Disable)/ 01(No-rotation)/ 02(Rotation)/ 03(IVMS)	00
<b>HA-02</b> Auto-tuning RUN command source selection	00(Keypad "RUN" key)/ 01(Setting by [AA111]/[AA211])	00
<b>HA-03</b> Online auto-tuning selection	00(Disable)/ 01(Enable)	00

- After setting the motor basic parameters, by the auto-tuning operation the constant of the motor will be able to be acquired.
- For no-rotation auto-tuning, the following variables are acquired, IM:[Hb110] to [Hb114], SM(PMM):[Hd110] to [Hd114].
- For rotation auto-tuning, the following variables are acquired, IM:[Hb110] to [Hb118]. Keep the operation conditions, as the motor can rotate.
- Auto-tuning start is done by the RUN-key ([HA-02] Initial value)

Motor stabilization (Hunting)

Code/Name	Range (unit)	Initial value
<b>HA110</b> Stabilization constant, 1st-motor	0 to 1000(%)	100
<b>HA112</b> Stabilization ramp function end ratio, 1st-motor *1)	0 to 100(%)	30
<b>HA113</b> Stabilization ramp function start ratio, 1st-motor *1)	0 to 100(%)	10

\*1) [HA112]/[HA113] are parameters added to Ver2.03 or later.

- If hunting occurs while a pump or a fan is being operated, lower the stabilization constant for adjustment.
- In the case the load is relatively light and hunting occurs, then increase the stabilization constant.
- [HA112] and [HA113] adjust the output frequency characteristics of [HA110] stabilization constant. Be sure to set the start ratio to a value smaller than the end ratio. When "Start ratio > End ratio", the end ratio setting is ignored and the same value as the start ratio is set.

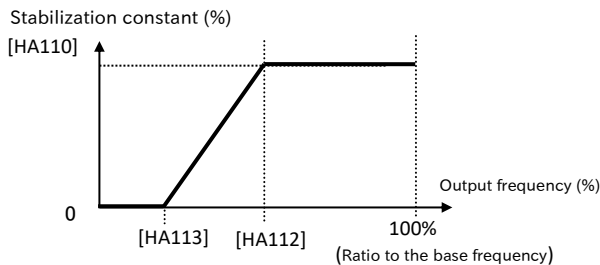

Control mode response adjustment

Code/Name	Range (unit)	Initial value
<b>HA115</b> Speed response, 1st-motor	0 to 1000(%)	100

- The speed response in the operation control of the inverter will be adjusted.
- ⇒ [AA121] control mode

[HA120] to [HA134]

Control response ASR gain switching

Code/Name	Range (unit)	Initial value
<b>HA120</b> ASR gain switching mode selection, 1st-motor	00([CAS] terminal)/ 01(Parameter setting)	00
<b>HA121</b> ASR gain switching time setting, 1st-motor	0 to 10000(ms)	100
<b>HA122</b> ASR gain mapping intermediate speed 1, 1st-motor	0.00 to 590.00(Hz)	0.00
<b>HA123</b> ASR gain mapping intermediate speed 2, 1st-motor	0.00 to 590.00(Hz)	0.00
<b>HA124</b> ASR gain mapping maximum speed, 1st-motor	0.00 to 590.00(Hz)	0.00
<b>HA125</b> ASR gain mapping P-gain 1, 1st-motor	0.0 to 1000.0(%)	100.0
<b>HA126</b> ASR gain mapping I-gain 1, 1st-motor	0.0 to 1000.0(%)	100.0
<b>HA127</b> ASR gain mapping P control P-gain 1, 1st-motor	0.0 to 1000.0(%)	100.0
<b>HA128</b> ASR gain mapping P-gain 2, 1st-motor	0.0 to 1000.0(%)	100.0
<b>HA129</b> ASR gain mapping I-gain 2, 1st-motor	0.0 to 1000.0(%)	100.0
<b>HA130</b> ASR gain mapping P control P-gain 2, 1st-motor	0.0 to 1000.0(%)	100.0
<b>HA131</b> ASR gain mapping P-gain 3, 1st-motor	0.0 to 1000.0(%)	100.0
<b>HA132</b> ASR gain mapping I-gain 3, 1st-motor	0.0 to 1000.0(%)	100.0
<b>HA133</b> ASR gain mapping P-gain 4, 1st-motor	0.0 to 1000.0(%)	100.0
<b>HA134</b> ASR gain mapping I-gain 4, 1st-motor	0.0 to 1000.0(%)	100.0

\*ASR: Automatic Speed Regulator

- Speed response gain of the motor control can be changed.
- The PI gain used for control is as follows according to the state of the input terminal 063[CAS] and 064[PPI] terminals.

■ In the case of input terminal [CAS]

witching, [HA120]=00

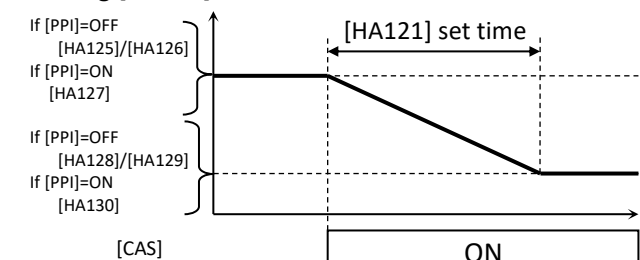

■ In case of Control Gain Mapping, [HA120]=01

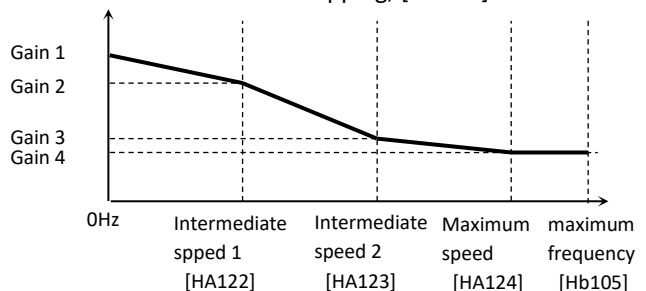

## [HA210] to [HA234]

2nd motor When Intelligent Input terminal 024[SET] is enabled.

Code/Name	Range (unit)	Initial value
<b>HA210</b> Stabilization constant, 2nd-motor	Same as HA110	
<b>HA112</b> Stabilization ramp function end ratio, 2nd-motor	Same as HA112	
<b>HA113</b> Stabilization ramp function start ratio, 2nd-motor	Same as HA113	
<b>HA215</b> Speed response, 2nd-motor	Same as HA115	
<b>HA220</b> ASR gain switching mode selection, 2nd-motor	Same as HA120	
<b>HA221</b> ASR gain switching time setting, 2nd-motor	Same as HA121	
<b>HA222</b> ASR gain mapping intermediate speed 1, 2nd-motor	Same as HA122	
<b>HA223</b> ASR gain mapping intermediate speed 2, 2nd-motor	Same as HA123	
<b>HA224</b> ASR gain mapping maximum speed, 2nd-motor	Same as HA124	
<b>HA225</b> ASR gain mapping P-gain 1, 2nd-motor	Same as HA125	
<b>HA226</b> ASR gain mapping I-gain 1, 2nd-motor	Same as HA126	
<b>HA227</b> ASR gain mapping P control P-gain 1, 2nd-motor	Same as HA127	
<b>HA228</b> ASR gain mapping P-gain 2, 2nd-motor	Same as HA128	
<b>HA229</b> ASR gain mapping I-gain 2, 2nd-motor	Same as HA129	
<b>HA230</b> ASR gain mapping P control P-gain 2, 2nd-motor	Same as HA130	
<b>HA231</b> ASR gain mapping P-gain 3, 2nd-motor	Same as HA131	
<b>HA232</b> ASR gain mapping I-gain 3, 2nd-motor	Same as HA132	
<b>HA233</b> ASR gain mapping P-gain 4, 2nd-motor	Same as HA133	
<b>HA234</b> ASR gain mapping I-gain 4, 2nd-motor	Same as HA134	

## [Hb102] to [Hb108]

## Basic parameters for Induction motor

Code/Name	Range (unit)	Initial value
<b>Hb102</b> Async. Motor capacity setting, 1st-motor	0.01 to 160.00 (kW) (0.01 to 500.00(kW))	Motor capacity setting (For the P1-1600H or above models, the maximum setting range is 500.00 (kW). )
<b>Hb103</b> Async. Motor number of poles setting, 1st-motor	0 to 23 ( 2 poles to 48 poles )	1 (4 Poles)
<b>Hb104</b> Async. Motor base frequency setting, 1st-motor	10.00 to [Hb105] (Hz)	60.00(JPN)(USA)/ 50.00(EU)(ASIA)(CHN)
<b>Hb105</b> Async. Motor maximum frequency setting, 1st-motor	[Hb104] to 590.00 (Hz)	60.00(JPN)(USA)/ 50.00(EU)(ASIA)(CHN)
<b>Hb106</b> Async. Motor rated voltage, 1st-motor	1 to 1000 (V)	(200V Class) 200(JPN) 230(EU)(USA)(ASIA)(CHN) (400V Class) 400(JPN)(EU)(ASIA)(CHN) 460(USA)
<b>Hb108</b> Async. Motor rated current, 1st-motor	0.01 to 10000.00 (A)	Motor capacity setting

- If the motor capacity [Hb102] and number of poles [Hb103] are changed, the motor characteristics are set according to the internal Hitachi table values.
- The output is decided by setting the frequency and voltage. Below there is an example of V/f control.

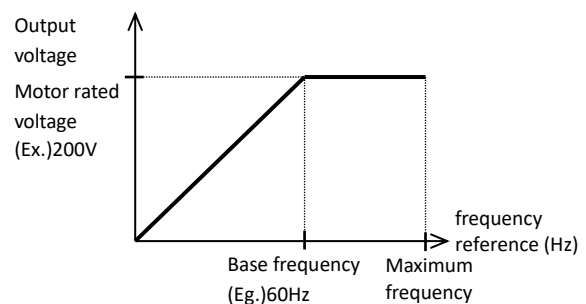

- By setting the motor rated current, a reference current for the motor protection is set.

※Initial value depends on the inverter.

Motor typical data	Code	Range of values (Unit)
Capacity	[Hb102]	0.01 to 160.00 (kW) (0.01 to 500(kW)) for P1-1600H or above models)
Number of poles	[Hb103]	0 to 23 (2 poles to 48 poles)
Frequency	[Hb104]	10.00 to 590.00 (Hz)
	[Hb105]	10.00 to 590.00 (Hz)
Voltage	[Hb106]	1 to 1000 (V)
Current	[Hb108]	0.01 to 10000.00 (A)

[Hb110] to [Hb131]

Induction motor constants

Code/Name	Range (unit)	Initial value
<b>Hb110</b> Async. Motor constant R1, 1st-motor	0.000001 to 1000.000000 (Ω)	Motor capacity setting
<b>Hb112</b> Async. Motor constant R2, 1st-motor	0.000001 to 1000.000000 (Ω)	Motor capacity setting
<b>Hb114</b> Async. Motor constant L, 1st-motor	0.000001 to 1000.000000 (mH)	Motor capacity setting
<b>Hb116</b> Async. Motor constant I0, 1st-motor	0.01 to 10000.00 (A)	Motor capacity setting
<b>Hb118</b> Async. Motor constant J, 1st-motor	0.00001 to 10000.00000 (kgm2)	Motor capacity setting

- If the motor capacity[Hb102] and number of poles [Hb103] are changed, the motor characteristics are set according to the internal Hitachi table values.
- For no-rotation auto-tuning, the following variables are acquired:[Hb110] to [Hb114].
- For rotation auto-tuning, the following variables are acquired:[Hb110] to [Hb118]
- It is possible to input the data obtained from the motor manufacturer. However, it must also include the data of the wiring and the like.

Minimum frequency setting

Code/Name	Range (unit)	Initial value
<b>Hb130</b> Minimum frequency adjustment, 1st-motor	0.10 to 10.00(Hz)	0.50
<b>Hb131</b> Reduced voltage start time setting, 1st-motor	0 to 2000(ms)	36

- If the torque at the time of start-up is not enough, you can change the setting to raise the minimum frequency.
- if the trip occurs when raised the minimum frequency, set a longer "reduced voltage start time setting".

(Example1) When the Reduced voltage start time setting =0ms.

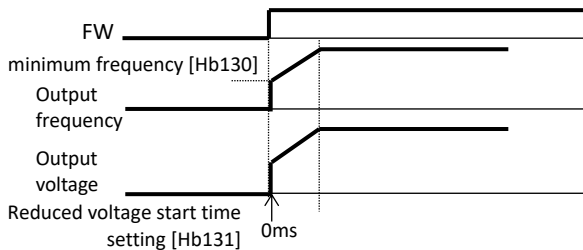

(Example2) When the Reduced voltage start time setting =10ms.

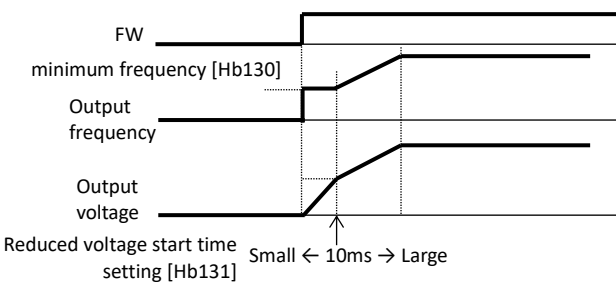

[Hb140] to [Hb146]

Manual torque boost adjustment

Code/Name	Range (unit)	Initial value
<b>Hb140</b> Manual torque boost operation mode selection, 1st-motor	00(Disabled)/ 01(Always enable)/ 02(Enable at Forward rotation)/ 03(Enable at Reverse rotation)	01
<b>Hb141</b> Manual torque boost value, 1st-motor	0.0 to 20.0(%)	0.0
<b>Hb142</b> Manual torque boost peak speed, 1st-motor	0.0 to 50.0(%)	0.0

- The manual torque boost operation mode selection will allow to restrict the boost to forward only or reverse only operation.
- Example [Hb140]=02

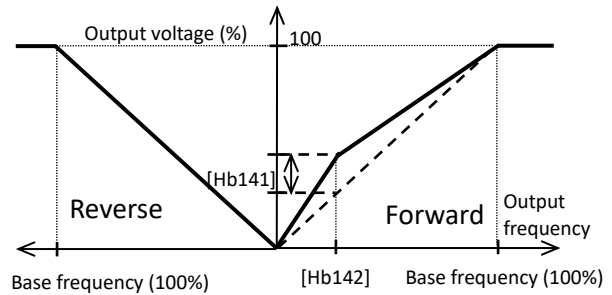

Eco Drive function

Code/Name	Range (unit)	Initial value
<b>Hb145</b> Eco drive enable, 1st-motor	00(Disable)/ 01(Enable)	00
<b>Hb146</b> Eco drive response adjustment, 1st-motor	0 to 100	050

- In V / f control, when the eco-drive function is enabled, the energy saving control operates.

[Hb150] to [Hb171]

Free V/f setting

Code/Name	Range (unit)	Initial value
<b>Hb150</b> Free-V/f frequency 1 setting, 1st-motor	0.00 to [Hb152](Hz)	0.00
<b>Hb151</b> Free-V/f voltage 1 setting, 1st-motor	0.0 to 1000.0(V)	0.0
<b>Hb152</b> Free-V/f frequency 2 setting, 1st-motor	[Hb150] to [Hb154](Hz)	0.00
<b>Hb153</b> Free-V/f voltage 2 setting, 1st-motor	0.0 to 1000.0(V)	0.0
<b>Hb154</b> Free-V/f frequency 3 setting, 1st-motor	[Hb152] to [Hb156](Hz)	0.00
<b>Hb155</b> Free-V/f voltage 3 setting, 1st-motor	0.0 to 1000.0(V)	0.0
<b>Hb156</b> Free-V/f frequency 4 setting, 1st-motor	[Hb154] to [Hb158](Hz)	0.00
<b>Hb157</b> Free-V/f voltage 4 setting, 1st-motor	0.0 to 1000.0(V)	0.0
<b>Hb158</b> Free-V/f frequency 5 setting, 1st-motor	[Hb156] to [Hb160](Hz)	0.00
<b>Hb159</b> Free-V/f voltage 5 setting, 1st-motor	0.0 to 1000.0(V)	0.0
<b>Hb160</b> Free-V/f frequency 6 setting, 1st-motor	[Hb158] to [Hb162](Hz)	0.00
<b>Hb161</b> Free-V/f voltage 6 setting, 1st-motor	0.0 to 1000.0(V)	0.0
<b>Hb162</b> Free-V/f frequency 7 setting, 1st-motor	[Hb160] to [Hb164](Hz)	0.00
<b>Hb163</b> Free-V/f voltage 7 setting, 1st-motor	0.0 to 1000.0(V)	0.0

- For the Frequency 1(f1) to the frequency (f7), set values smaller than the base frequency. And, for the corresponding voltage 1(V1) to voltage 7(V7), set values smaller than the rated voltage. In the case of the high-frequency motor, set the base / maximum frequency at first.

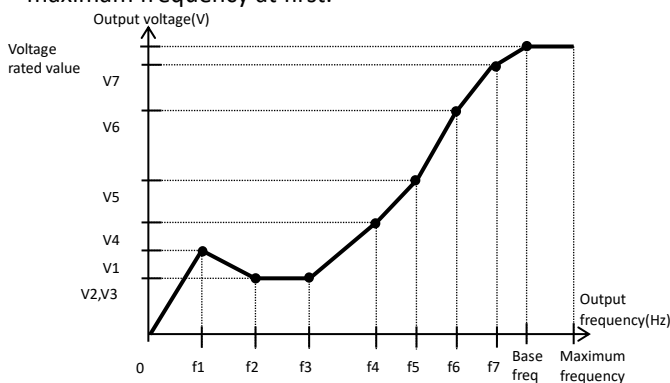

V/f feedback control adjustment

Code/Name	Range (unit)	Initial value
<b>Hb170</b> Slip compensation P-gain at V/f with encoder, 1st-motor	0 to 1000(%)	100
<b>Hb171</b> Slip compensation I-gain at V/f with encoder, 1st-motor	0 to 1000(%)	100

- When [AA121] is set as feedback control, slip compensation is possible.

[Hb180] [Hb202] to [Hb280]

Output voltage adjustment

Code/Name	Range (unit)	Initial value
<b>Hb180</b> Output voltage gain, 1st-motor	0 to 255(%)	100

- When the motor is hunting, there is a possibility that the motor stabilizes by adjustment of the output voltage gain.

2nd motor When Intelligent Input terminal 024[SET] is enabled.

Code/Name	Range (unit)	Initial value
<b>Hb202</b> Async. Motor capacity setting, 2nd-motor	Same as Hb102	
<b>Hb203</b> Async. Motor number of poles setting, 2nd-motor	Same as Hb103	
<b>Hb204</b> Async. Motor base frequency setting, 2nd-motor	Same as Hb104	
<b>Hb205</b> Async. Motor maximum frequency setting, 2nd-motor	Same as Hb105	
<b>Hb206</b> Async. Motor rated voltage, 2nd-motor	Same as Hb106	
<b>Hb208</b> Async. Motor rated current, 2nd-motor	Same as Hb108	
<b>Hb210</b> Async. Motor constant R1, 2nd-motor	Same as Hb110	
<b>Hb212</b> Async. Motor constant R2, 2nd-motor	Same as Hb112	
<b>Hb214</b> Async. Motor constant L, 2nd-motor	Same as Hb114	
<b>Hb216</b> Async. Motor constant Io, 2nd-motor	Same as Hb116	
<b>Hb218</b> Async. Motor constant J, 2nd-motor	Same as Hb118	

2nd motor When Intelligent Input terminal 024[SET] is enabled.

Code/Name	Range (unit)	Initial value
<b>Hb230</b> Minimum frequency adjustment, 2nd-motor	Same as Hb130	
<b>Hb231</b> Reduced voltage start time setting, 2nd-motor	Same as Hb131	
<b>Hb240</b> Manual torque boost operation mode selection, 2nd-motor	Same as Hb140	
<b>Hb241</b> Manual torque boost value, 2nd-motor	Same as Hb141	
<b>Hb242</b> Manual torque boost Peak speed, 2nd-motor	Same as Hb142	
<b>Hb245</b> Eco drive enable, 2nd-motor	Same as Hb145	
<b>Hb246</b> Eco drive response adjustment, 2nd-motor	Same as Hb146	
<b>Hb250</b> Free-V/f frequency 1 setting, 2nd-motor	Same as Hb150	
<b>Hb251</b> Free-V/f voltage 1 setting, 2nd-motor	Same as Hb151	
<b>Hb252</b> Free-V/f frequency 2 setting, 2nd-motor	Same as Hb152	
<b>Hb253</b> Free-V/f voltage 2 setting, 2nd-motor	Same as Hb153	
<b>Hb254</b> Free-V/f frequency 3 setting, 2nd-motor	Same as Hb154	
<b>Hb255</b> Free-V/f voltage 3 setting, 2nd-motor	Same as Hb155	
<b>Hb256</b> Free-V/f frequency 4 setting, 2nd-motor	Same as Hb156	
<b>Hb257</b> Free-V/f voltage 4 setting, 2nd-motor	Same as Hb157	
<b>Hb258</b> Free-V/f frequency 5 setting, 2nd-motor	Same as Hb158	
<b>Hb259</b> Free-V/f voltage 5 setting, 2nd-motor	Same as Hb159	
<b>Hb260</b> Free-V/f frequency 6 setting, 2nd-motor	Same as Hb160	
<b>Hb261</b> Free-V/f voltage 6 setting, 2nd-motor	Same as Hb161	
<b>Hb262</b> Free-V/f frequency 7 setting, 2nd-motor	Same as Hb162	
<b>Hb263</b> Free-V/f voltage 7 setting, 2nd-motor	Same as Hb163	
<b>Hb270</b> Slip compensation P-gain at V/f with encoder, 2nd-motor	Same as Hb170	
<b>Hb271</b> Slip compensation I-gain at V/f with encoder, 2nd-motor	Same as Hb171	
<b>Hb280</b> Output voltage gain, 2nd-motor	Same as Hb180	

## [HC101] to [HC121]

## Automatic torque boost adjustment

Code/Name	Range (unit)	Initial value
<b>HC101</b> Automatic torque boost voltage compensation gain, 1st-motor	0 to 255(%)	100
<b>HC102</b> Automatic torque boost slip compensation gain, 1st-motor	0 to 255(%)	100

- These parameters are adjusted when the automatic torque boost control function is selected in [AA121]. For more information, refer to the P1 user's guide.

## Vector control start adjustment

Code/Name	Range (unit)	Initial value
<b>HC110</b> Zero speed range limit, 1st-motor(IM-0Hz-SLV)	0 to 100(%)	80
<b>HC111</b> Boost value at start, 1st-motor (IM-SLV,IM-CLV)	0 to 50(%)	0
<b>HC112</b> Boost value at start, 1st-motor (IM-0Hz-SLV)	0 to 50(%)	10

- When [AA121] is sensorless vector control or 0Hz-range sensorless vector control, start boost is possible.

## Secondary resistor compensation function

Code/Name	Range (unit)	Initial value
<b>HC113</b> Secondary resistance (R2) correction, 1st-motor	00(Disable)/ 01(Enable)	00

- When the vector control (with encoder/ sensorless/0Hz) is being used and the temperature of the motor can be sensed, the inverter is capable of reducing the speed variations due to temperature changes.
- If use this function, use a thermistor PB-41E from SHIBAURA ELECTRONICS CO., LTD. And also, it is necessary to set [Cb-40] to 02 (NTC).

## Reverse run protection function

Code/Name	Range (unit)	Initial value
<b>HC114</b> Direction reversal protection, 1st-motor	00(Disable)/ 01(Enable)	00

- This function is to prevent the change of direction of the output in a low frequency range for vector control such as (SLV/0Hz-SLV/CLV)

## Torque reference value conversion method

Code/Name	Range (unit)	Initial value
<b>HC115</b> Torque conversion method selection, 1st-motor *1)	00(Torque)/ 01(Current)	00

- \*1) [HC115]/[HC215] are parameters added to Ver2.02 or later.
- Select the 100% reference value of the torque related setting parameter. (Setting 01 is the same method as the SJ700 series.) For details, refer to the P1 User's Guide.

## [HC120] to [HC242]

## Motor control adjustment gain

Code/Name	Range (unit)	Initial value
<b>HC120</b> Torque current reference filter time constant, 1st-motor	0 to 100(ms)	2
<b>HC121</b> Speed feedforward compensation gain, 1st-motor	0 to 1000(%)	0
<b>HC137</b> Flux settling level, 1st-motor *2)	0.0 to 100.0(%)	80.0
<b>HC140</b> Forcing level, 1st-motor *2)	0 to 1000(%)	100
<b>HC141</b> Modulation threshold 1, 1st-motor *2)	0 to 133(%)	115
<b>HC142</b> Modulation threshold 2, 1st-motor *2)	0 to 133(%)	115

- [HC120] to [HC142] are effective when the control mode is sensorless vector control(IM), Zero-Hz-range sensorless vector control (IM) or Vector control with encoder (IM).
- [HC120] sets a filter for torque command.
- [HC121] adjusts the compensation of feedforward control.
- [HC137] adjusts the magnetic flux establishment level at startup. If this is set to a small, the waiting time until acceleration starts can be shortened, but the startup operation may become unstable.
- [HC140] adjusts the output current level during pre-excitation. The basis current value is as follows depending on the control mode.

08:Sensorless vector control (IM) 09:Vector control with encoder(IM)	[Hb116] Async. Motor constant I0
10:Zero-Hz-range sensorless vector control	[HC110] Zero speed range limit (IM -0Hz-SLV)

- [HC141]/[HC142] adjust the upper limit of the inverter output voltage level. By increasing these parameters the output current may be reduced, and the operation may become unstable. Be sure to set the same value for [HC141] and [HC142].

**2nd motor** When Intelligent Input terminal 024[SET] is enabled.

Code/Name	Range (unit)	Initial value
<b>HC201</b> Automatic torque boost voltage compensation gain, 2nd-motor	Same as HC101	
<b>HC202</b> Automatic torque boost slip compensation gain, 2nd-motor	Same as HC102	
<b>HC210</b> Zero speed range limit, 2nd-motor(IM-0Hz-SLV)	Same as HC110	
<b>HC211</b> Boost value at start, 2nd-motor(IM-SLV,IM-CLV)	Same as HC111	
<b>HC212</b> Boost value at start, 2nd-motor(IM-0Hz-SLV)	Same as HC112	
<b>HC213</b> Secondary resistor (R2) compensation enable, 2nd-motor	Same as HC113	
<b>HC214</b> Direction reversal protection, 2nd-motor	Same as HC114	
<b>HC215</b> Torque conversion method selection, 2nd-motor	Same as HC115	
<b>HC220</b> Torque current reference filter time constant, 2nd-motor	Same as HC120	
<b>HC221</b> Speed feedforward compensation gain, 2nd-motor	Same as HC121	
<b>HC237</b> Flux settling level, 2nd-motor *2)	Same as HC137	
<b>HC240</b> Forcing level, 2nd-motor *2)	Same as HC140	
<b>HC241</b> Modulation threshold 1, 2nd-motor *2)	Same as HC141	
<b>HC242</b> Modulation threshold 2, 2nd-motor *2)	Same as HC142	

- \*2)[HC137]/[HC237],[HC140]/[HC240],[HC141]/[HC241],[HC142]/[HC242] are parameters added to Ver2.03 or later.



[Hd102] to [Hd118]

[Hd130] to [Hd-58]

**Permanent Magnet Sync. Motor(SM/PMM)  
basic parameters**

Code/Name	Range (unit)	Initial value
<b>Hd102</b> Sync. Motor capacity setting, 1st-motor	0.01 to 160.00(kW) (0.01 to 500.00(kW))	Factory setting (The maximum value of the setting range is 500.00 (kW) for P1-1600H or above models.)
<b>Hd103</b> Sync. Motor number of poles setting, 1st-motor	0 to 23 (2 poles to 48 Poles)	Factory setting
<b>Hd104</b> Sync. Motor Base frequency setting, 1st-motor	10.00 to [Hd105](Hz)	Factory setting
<b>Hd105</b> Sync. Motor Maximum frequency setting, 1st-motor	[Hd104] to 590.00(Hz)	Factory setting
<b>Hd106</b> Sync. Motor rated voltage, 1st-motor	1 to 1000(V)	Factory setting
<b>Hd108</b> Sync. Motor rated current, 1st-motor	0.01 to 10000.00 (A)	Factory setting

Code/Name	Range (unit)	Initial value
<b>Hd110</b> Sync. Motor constant R, 1st-motor	0.000001 to 1000.000000 (Ω)	Factory setting
<b>Hd112</b> Sync. Motor constant Ld, 1st-motor	0.000001 to 1000.000000 (mH)	Factory setting
<b>Hd114</b> Sync. Motor constant Lq, 1st-motor	0.000001 to 1000.000000 (mH)	Factory setting
<b>Hd116</b> Sync. Motor constant Ke, 1st-motor	0.1 to 100000.0 (mVs/rad)	Factory setting
<b>Hd118</b> Sync. Motor constant J, 1st-motor	0.00001 to 10000.00000 (kgm2)	Factory setting

- The motor capacity and the number of poles will be set by Hitachi characteristics table.
- For SM/PMM, frequency, voltage, and the motor constants setting are necessary.
- If the maximum current of the motor is decided, Set the Overcurrent detection level [bb160] with a margin.

Motor typical data	Code	Range of values (unit)
Capacity	[Hd102]	0.01 to 160.00 (kW) (0.01 to 500.00(kW)) for P1-1600H or above models)
Number of poles	[Hd103]	0 to 23 (2 poles to 48 Poles)
Frequency	[Hd104]	10.00 to 590.00 (Hz)
	[Hd105]	10.00 to 590.00 (Hz)
Voltage	[Hd106]	1 to 1000 (V)
Current	[Hd108]	0.01 to 10000.00 (A)

※Initial value depends on the inverter.

- If motor capacity [Hd102], number of poles [Hd103] are changed, the motor characteristics are set according to the internal Hitachi table values.
- The values of [Hd110] to [Hd114] can be acquired by no rotation auto-tuning.

**Minimum frequency setting**

Code/Name	Range (unit)	Initial value
<b>Hd130</b> Minimum frequency adjustment for Sync.M, 1st-motor	0 to 50(%)	8
<b>Hd131</b> No-Load current for Sync.M, 1st-motor	0 to 100(%)	10

- The synchronous control is switched to sensorless vector control when the frequency reference is the base frequency[Hd104] × [Hd130].
- By [Hd131], the sensorless vector control no-load current is set.

**Magnetic pole position estimation SM(PMM)**

Code/Name	Range (unit)	Initial value
<b>Hd132</b> Starting method for Sync.M, 1st-motor	00(Synchronous)/ 01(Initial motor position estimate (IMPE))	00
<b>Hd133</b> IMPE OV wait number for Sync.M, 1st-motor	0 to 255	10
<b>Hd134</b> IMPE detect wait number for Sync.M, 1st-motor	0 to 255	10
<b>Hd135</b> IMPE detect number for Sync.M, 1st-motor	0 to 255	30
<b>Hd136</b> IMPE voltage gain for Sync.M, 1st-motor	0 to 200(%)	100
<b>Hd137</b> IMPE Mg-pole position offset, 1st-motor	0 to 359(deg)	0

- For SM/PMM, if initial motor position estimate is enabled by [Hd132], the inverter drives after magnetic pole position estimation. If a slight reverse rotation occurs at startup after the magnetic pole position estimation operation, set the start position offset in the operation direction to [Hd137].

**IVMS setting**

Code/Name	Range(unit)	Initial Value
<b>Hd-41</b> IVMS carrier frequency	0.5 to 16.0(kHz)	2.0
<b>Hd-42</b> Filter gain of IVMS current detection	0 to 1000	100
<b>Hd-43</b> Open-phase voltage detection gain	00/01/02/03	00
<b>Hd-44</b> Open-phase switching threshold compensation	00(Disable)/ 01(Enable)	01
<b>Hd-45</b> SM(PMM)-IVMS speed control P gain	0 to 1000	100
<b>Hd-46</b> SM(PMM)-IVMS speed control I gain	0 to 10000	100
<b>Hd-47</b> SM(PMM)-IVMS wait time for open-phase switching	0 to 1000	15
<b>Hd-48</b> SM(PMM)-IVMS restriction on the rotation-direction determination	00(Disable)/ 01(Enable)	01
<b>Hd-49</b> SM(PMM)-IVMS open-phase voltage detection timing adjustment,	0 to 1000	10
<b>Hd-50</b> SM(PMM)-IVMS minimum pulse width adjustment,	0 to 1000	100
<b>Hd-51</b> IVMS threshold current limit	0 to 255(%)	100
<b>Hd-52</b> IVMS threshold gain	0 to 255(%)	100
<b>Hd-58</b> IVMS carrier-frequency switching start/finish point *1)	0 to 50(%)	5

\*1) Depends on the base frequency

- Above parameters are for adjustment in SM(PMM) driving with IVMS.

[Hd202] to [Hd237]

2nd motor When Intelligent Input terminal O24[SET] is enabled.

Code/Name	Range (unit)	Initial value
Perm. Magnet Sync. Motor (SM/PMM)	<b>Hd202</b> Sync. Motor capacity setting, 2nd-motor	Same as Hd102
	<b>Hd203</b> Sync. Motor number of poles setting, 2nd-motor	Same as Hd103
	<b>Hd204</b> Sync. Base frequency setting, 2nd-motor	Same as Hd104
	<b>Hd205</b> Sync. Maximum frequency setting, 2nd-motor	Same as Hd105
	<b>Hd206</b> Sync. Motor rated voltage, 2nd-motor	Same as Hd106
	<b>Hd208</b> Sync. Motor rated current, 2nd-motor	Same as Hd108
	<b>Hd210</b> Sync. Motor constant R, 2nd-motor	Same as Hd110
	<b>Hd212</b> Sync. Motor constant Ld, 2nd-motor	Same as Hd112
	<b>Hd214</b> Sync. Motor constant Lq, 2nd-motor	Same as Hd114
	<b>Hd216</b> Sync. Motor constant Ke, 2nd-motor	Same as Hd116
<b>Hd218</b> Sync. Motor constant J, 2nd-motor	Same as Hd118	

2nd motor When Intelligent Input terminal O24[SET] is enabled.

Code/Name	Range (unit)	Initial value
<b>Hd230</b> Minimum frequency adjustment for Sync.M, 2nd-motor	Same as Hd130	
<b>Hd231</b> No-Load current for Sync.M, 2nd-motor	Same as Hd131	
<b>Hd232</b> Starting method for Sync.M, 2nd-motor	Same as Hd132	
<b>Hd233</b> IMPE OV wait number for Sync.M, 2nd-motor	Same as Hd133	
<b>Hd234</b> IMPE detect wait number for Sync.M, 2nd-motor	Same as Hd134	
<b>Hd235</b> IMPE detect number for Sync.M, 2nd-motor	Same as Hd135	
<b>Hd236</b> IMPE voltage gain for Sync.M, 2nd-motor	Same as Hd136	
<b>Hd237</b> IMPE Mg-pole position offset, 2nd-motor	Same as Hd137	

[oA-10] to [oA-33][ob-01] to [ob-04]

Parameter mode (o code)

- "o" parameters are displayed by the [UA-22] = 01. This configuration is not necessary except when option is used.
- The implementation of the following parameters might differ depending on the type of option being used. For more information, refer to the Option's User's guide and the P1 User's guide.

Optional cassette error operation

Code/Name	Range (unit)	Initial value
<b>oA-10</b> Operation selection at an option error (SLOT-1)	00(Error)/ 01((Ignore error (keep running)))	00
<b>oA-11</b> Communication Watch Dog Timer (SLOT-1)	0.00 to 100.00(s)	1.00
<b>oA-12</b> Action selection at a communication error (SLOT-1)	00(Error)/ 01(Trip after Deceleration stop)/ 02(Ignore)/ 03(Free run stop)/ 04(Deceleration stop)	01
<b>oA-13</b> RUN command selection at start up (SLOT-1)	00(Disable)/ 01(Enable)	00
<b>oA-20</b> Operation selection at an option error (SLOT-2)	00(Error)/ 01((Ignore error (keep running)))	00
<b>oA-21</b> Communication Watch Dog Timer (SLOT-2)	0.00 to 100.00(s)	1.00
<b>oA-22</b> Action selection at a communication error (SLOT-2)	00(Error)/ 01(Trip after Deceleration stop)/ 02(Ignore)/ 03(Free run stop)/ 04(Deceleration stop)	01
<b>oA-23</b> RUN command selection at start up (SLOT-2)	00(Disable)/ 01(Enable)	00
<b>oA-30</b> Operation selection at an option error (SLOT-3)	00(Error)/ 01((Ignore error (keep running)))	00
<b>oA-31</b> Communication Watch Dog Timer (SLOT-3)	0.00 to 100.00(s)	1.00
<b>oA-32</b> Action selection at a communication error (SLOT-3)	00(Error)/ 01(Trip after Deceleration stop)/ 02(Ignore)/ 03(Free run stop)/ 04(Deceleration stop)	01
<b>oA-33</b> RUN command selection at start up (SLOT-3)	00(Disable)/ 01(Enable)	00

- In P1-CCL CC-Link communication option, there are no dedicated parameters other than the above parameters. For more information, refer the Optional Guide and P1 User's Guide

P1-FB Encoder Feedback Option setting

Code/Name	Range (unit)	Initial value
<b>ob-01</b> Encoder constant setting (option)	32 to 65535(pls)	1024
<b>ob-02</b> Encoder phase sequence selection (option)	00(Phase-A Lead)/ 01(Phase-B Lead)	0
<b>ob-03</b> Motor gear ratio numerator (option)	1 to 10000	1
<b>ob-04</b> Motor gear ratio denominator (option)	1 to 10000	1

- Above parameters set the main encoder input and the motor gear ratio involved in the encoder feedback for the P1-FB.

## [ob-10] to [ob-16][oC-01] to [oC-28]

## [oE-01] to [oE-33]

**P1-FB Encoder Feedback Option****Pulse train input terminal setting**

Code/Name	Range (unit)	Initial value
<b>ob-10</b> Pulse train input, target function selection (option)	00(Frequency reference)/01(Pulse train position reference)	00
<b>ob-11</b> Pulse train input mode selection (option)	00(90° shift pulse train)/01(Forward/ Reverse pulse train and direction signal)/02(Forward pulse train and Reverse pulse train)	01
<b>ob-12</b> Pulse train frequency scale (option)	0.05 to 200.00(kHz)	25.00
<b>ob-13</b> Pulse train frequency filter time constant (option)	0.01 to 2.00(s)	0.10
<b>ob-14</b> Pulse train frequency bias value (option)	-100.0 to 100.0(%)	0.0
<b>ob-15</b> Pulse train upper frequency detection level( option)	0.0 to 100.0(%)	100.0
<b>ob-16</b> Pulse train lower frequency detection level (option)	0.0 to 100.0(%)	0.0

- Set the above parameters when using the option feedback.
- For more detail, refer to optional cassette User's Guide.

**P1-FS Functional Safety Option operation**

Code/Name	Range(unit)	Initial value
<b>oC-01</b> Safety option input display selection	00(Warning: with display)/01(Warning: without display)	00
<b>oC-10</b> SS1-A deceleration time setting	0.00 to 3600.00(s)	30.00
<b>oC-12</b> SLS-A deceleration time setting	0.00 to 3600.00(s)	30.00
<b>oC-14</b> SLS-A speed upper limit (Forward)	0.00 to 590.00(Hz)	0.00
<b>oC-15</b> SLS-A speed upper limit (Reverse)	0.00 to 590.00(Hz)	0.00
<b>oC-16</b> SDI-A deceleration time setting	0.00 to 3600.00(s)	30.00
<b>oC-18</b> SDI-A direction limit mode	00(Limit) 01(Invert)	00
<b>oC-20</b> SS1-B deceleration time setting	0.00 to 3600.00(s)	30.00
<b>oC-22</b> SLS-B deceleration time setting	0.00 to 3600.00(s)	30.00
<b>oC-24</b> SLS-B speed upper limit (Forward)	0.00 to 590.00(Hz)	0.00
<b>oC-25</b> SLS-B speed upper limit (Reverse)	0.00 to 590.00(Hz)	0.00
<b>oC-26</b> SDI-B deceleration time setting	0.00 to 3600.00(s)	30.00
<b>oC-28</b> SDI-B direction limit mode	00(Limit)/01(Invert)	00

- For more detail, refer to optional board User's Guide.

**P1-AG Analog Input/Output Option****analog input adjustment**

Code/Name	Range (unit)	Initial value
<b>oE-01</b> [Ai4] Filter time constant	1 to 500(ms)	16
<b>oE-03</b> [Ai4] Start value	0.00 to 100.00(%)	0.00
<b>oE-04</b> [Ai4] End value	0.00 to 100.00(%)	100.00
<b>oE-05</b> [Ai4] Start rate	0.0 to [oE-06] (%)	0.0
<b>oE-06</b> [Ai4] End rate	[oE-05] to 100.0(%)	100.0
<b>oE-07</b> [Ai4] Start point selection	00(Start value[oE-03])/01(0%)	01
<b>oE-11</b> [Ai5] Filter time constant	1 to 500(ms)	16
<b>oE-13</b> [Ai5] Start value	0.00 to 100.00(%)	0.00
<b>oE-14</b> [Ai5] End value	0.00 to 100.00(%)	100.00
<b>oE-15</b> [Ai5] Start rate	0.0 to [oE-16] (%)	0.0
<b>oE-16</b> [Ai5] End rate	[oE-15] to 100.0(%)	100.0
<b>oE-17</b> [Ai5] Start point selection	00(Start value[oE-13])/01(0%)	01
<b>oE-21</b> [Ai6] Filter time constant	1 to 500(ms)	16
<b>oE-23</b> [Ai6] Start value	-100.00 to 100.00(%)	-100.00
<b>oE-24</b> [Ai6] End value	-100.00 to 100.00(%)	100.00
<b>oE-25</b> [Ai6] Start rate	-100.0 to [oE-26] (%)	-100.0
<b>oE-26</b> [Ai6] End rate	[oE-25] to 100.0(%)	100.0
<b>oE-28</b> [Ai4] Voltage/Current bias adjustment	-100.00 to 100.00(%)	0.00
<b>oE-29</b> [Ai4] Voltage/Current gain adjustment	0.00 to 200.00(%)	100.00
<b>oE-30</b> [Ai5] Voltage/Current bias adjustment	-100.00 to 100.00(%)	0.00
<b>oE-31</b> [Ai5] Voltage/Current gain adjustment	0.00 to 200.00(%)	100.00
<b>oE-32</b> [Ai6] Voltage bias adjustment	-100.00 to 100.00(%)	0.00
<b>oE-33</b> [Ai6] Voltage gain adjustment	0.00 to 200.00(%)	100.00

- Regarding the adjustment method of the analog input/output option, refer to the P1 user's guide and P1-AG user's guide.

## [oE-35] to [oE-49]

**P1-AG Analog Input/Output Option**  
**Window comparator output condition**

Code/Name	Range (unit)	Initial value
<b>oE-35</b> [Ai4] Window comparator upper limit	0 to 100(%)	100
<b>oE-36</b> [Ai4] Window comparator lower limit	0 to 100(%)	0
<b>oE-37</b> [Ai4] Window comparator hysteresis width	0 to 10(%)	0
<b>oE-38</b> [Ai5] Window comparator upper limit	0 to 100(%)	100
<b>oE-39</b> [Ai5] Window comparator lower limit	0 to 100(%)	0
<b>oE-40</b> [Ai5] Window comparator hysteresis width	0 to 10(%)	0
<b>oE-41</b> [Ai6] Window comparator upper limit	-100 to 100(%)	100
<b>oE-42</b> [Ai6] Window comparator lower limit	-100 to 100(%)	-100
<b>oE-43</b> [Ai6] Window comparator hysteresis width	0 to 10(%)	0
<b>oE-44</b> [Ai4] Temporal operation level set at disconnection or compare event	0 to 100(%)	0
<b>oE-45</b> [Ai4] Temporal operation level implementation timing	00(Disable)/ 01(Enable: At WC* is active)/ 02(Enable: At WC* is not active)	00
<b>oE-46</b> [Ai5] Temporal operation level set at disconnection or compare event	0 to 100(%)	0
<b>oE-47</b> [Ai5] Temporal operation level implementation timing	00(Disable)/ 01(Enable: At WC* is active)/ 02(Enable: At WC* is not active)	00
<b>oE-48</b> [Ai6] Temporal operation level set at disconnection or compare event	-100 to 100(%)	0
<b>oE-49</b> [Ai6] Temporal operation level implementation timing	00(Disable)/ 01(Enable: At WC* is active)/ 02(Enable: At WC* is not active)	00

- Window comparator function output signals whenever the analog value inputs are within or out of range.
- In the case of disconnection judgment, the reference value can be set to the [oE-44]/[oE-46]/[oE-48] setting value when it is within or out of the range of the window comparator.

## [oE-50] to [oE-70] [oH-01] to [oH-06]

**P1-AG Analog Input/Output Option**  
**Analog output terminal adjustment**

Code/Name	Range (unit)	Initial value
<b>oE-50</b> [Ao3] Output monitor selection	Set monitor code	dA-01
<b>oE-51</b> [Ao4] Output monitor selection		dA-01
<b>oE-52</b> [Ao5] Output monitor selection		dA-01
<b>oE-56</b> [Ao3] Output filter time constant	1 to 500(ms)	100
<b>oE-57</b> [Ao3] Data type selection	00(Absolute value)/ 01(Signed value)	00
<b>oE-58</b> [Ao3] Bias adjustment	-100.0 to 100.0(%)	100.0
<b>oE-59</b> [Ao3] Gain adjustment	-1000.0 to 1000.0(%)	100.0
<b>oE-60</b> Adjustment mode [Ao3] output level	-100.0 to 100.0(%)	100.0
<b>oE-61</b> [Ao4] Output filter time constant	1 to 500(ms)	100
<b>oE-62</b> [Ao4] Data type selection	00(Absolute value)/ 01(Signed value)	00
<b>oE-63</b> [Ao4] Bias adjustment	-100.0 to 100.0(%)	0.0
<b>oE-64</b> [Ao4] Gain adjustment	-1000.0 to 1000.0(%)	100.0
<b>oE-65</b> Adjustment mode [Ao4] output level	-100.0 to 100.0(%)	100.0
<b>oE-66</b> [Ao5] Output filter time constant	1 to 500(ms)	100
<b>oE-67</b> [Ao5] Data type selection	00(Absolute value)/ 01(Signed value)	00
<b>oE-68</b> [Ao5] Bias adjustment	-100.0 to 100.0(%)	0.0
<b>oE-69</b> [Ao5] Gain adjustment	-1000.0 to 1000.0(%)	100.0
<b>oE-70</b> Adjustment mode [Ao5] output level	-100.0 to 100.0(%)	100.0

- Regarding the adjustment method of the analog input/output option, refer to the P1 user's guide and P1-AG user's guide.

**P1-EN Ethernet communication Option setting**

Code/Name	Range (unit)	Initial value
<b>oH-01</b> IP-address selection(P1-EN)	00(Group 1)/ 01(Group 2)	00
<b>oH-02</b> Communication speed (port-1) (P1-EN)	00(Auto-negotiation)/ 01(100M:full duplex)/ 02(100M:half duplex)/	00
<b>oH-03</b> Communication speed (port-2) (P1-EN)	03(10M:full duplex)/ 04(10M:half duplex)	00
<b>oH-04</b> Ethernet communication timeout(P1-EN)	1 to 65535(×10ms)	3000
<b>oH-05</b> Modbus TCP Port No.(IPv4) (P1-EN)	502, 1024 to 65535	502
<b>oH-06</b> Modbus TCP Port No.(IPv6) (P1-EN)	502, 1024 to 65535	502

- Refer to option User's Guide for more details.

## [oH-20] to [oH-45]

## [oJ-01] to [oJ-20]

**P1-PB PROFIBUS Communication Option setting**

Code/Name	Range (unit)	Initial value
<b>oH-20</b> PROFIBUS Node address(P1-PB)	0 to 125	0
<b>oH-21</b> Profibus Clear Mode selection(P1-PB)	<b>(For factory setting. Do not change.)</b>	00
<b>oH-22</b> Profibus Map selection(P1-PB)		00
<b>oH-23</b> Profibus master setting selection(P1-PB)		00
<b>oH-24</b> PROFIBUS Telegram group selection(P1-PB)	00(Gr.A)/01(Gr.B)/02(Gr.C)	00

• Refer to the Option User's Guide for more details.

**P1-PN PROFINET Communication Option setting**

Code/Name	Range (unit)	Initial value
<b>oH-30</b> PN IP-Address select(P1-PN)	<b>(For factory setting. Do not change.)</b>	00
<b>oH-31</b> PN Communication speed (port-1) (P1-PN)		00
<b>oH-32</b> PN Communication speed (port-2)(P1-PN)		00
<b>oH-33</b> PN Ethernet communication timeout(P1-PN)		3000
<b>oH-34</b> PROFINET Telegram group selection	00(Gr.A)/01(Gr.B)/02(Gr.C)	00

• Refer to the option User's Guide for more details.

**P1-DN DeviceNet Communication Option setting**

Code/Name	Range (unit)	Initial value
<b>oH-40</b> DeviceNet Node address (MAC ID)(P1-DN)	0 to 63	0
<b>oH-41</b> DeviceNet assembly instance number selection(P1-DN)	00(Instance 20, 70)/01(Instance 21, 71)/02(Instance 100, 150)/03(Instance 101, 151)/04(Instance 101, 153)/05(Instance 110, 111)/06(Instance 123, 173)/07(Instance 139, 159)	00
<b>oH-42</b> DeviceNet speed unit selection(P1-DN)	00(Hz)/ 01(min-1)	01
<b>oH-44</b> DeviceNet flexible Gr. format selection(P1-DN)	00(Gr. A)/01(Gr. B)/02(Gr. C)	00
<b>oH-45</b> DeviceNet idle mode action selection(P1-DN)	00(Trip)/01(Decel-Trip)/02(Ignore)/03(Free run stop)/04(Decel stop)/	00

• Refer to the Option User's Guide for more details.

**Communication Option Interface**

• Group A option I/F flexible command

Code/Name	Range (unit)	Initial value
<b>oJ-01</b> Writing register 1, Gr.A	0000 to FFFF	0000
<b>oJ-02</b> Writing register 2, Gr.A	0000 to FFFF	0000
<b>oJ-03</b> Writing register 3, Gr.A	0000 to FFFF	0000
<b>oJ-04</b> Writing register 4, Gr.A	0000 to FFFF	0000
<b>oJ-05</b> Writing register 5, Gr.A	0000 to FFFF	0000
<b>oJ-06</b> Writing register 6, Gr.A	0000 to FFFF	0000
<b>oJ-07</b> Writing register 7, Gr.A	0000 to FFFF	0000
<b>oJ-08</b> Writing register 8, Gr.A	0000 to FFFF	0000
<b>oJ-09</b> Writing register 9, Gr.A	0000 to FFFF	0000
<b>oJ-10</b> Writing register 10, Gr.A	0000 to FFFF	0000
<b>oJ-11</b> Reading register 1 Gr.A	0000 to FFFF	0000
<b>oJ-12</b> Reading register 2 Gr.A	0000 to FFFF	0000
<b>oJ-13</b> Reading register 3 Gr.A	0000 to FFFF	0000
<b>oJ-14</b> Reading register 4 Gr.A	0000 to FFFF	0000
<b>oJ-15</b> Reading register 5 Gr.A	0000 to FFFF	0000
<b>oJ-16</b> Reading register 6 Gr.A	0000 to FFFF	0000
<b>oJ-17</b> Reading register 7 Gr.A	0000 to FFFF	0000
<b>oJ-18</b> Reading register 8 Gr.A	0000 to FFFF	0000
<b>oJ-19</b> Reading register 9 Gr.A	0000 to FFFF	0000
<b>oJ-20</b> Reading register 10 Gr.A	0000 to FFFF	0000

• Refer to the Option User's Guide for more details.

**[oJ-21] to [oJ-40]**

- Group B option I/F flexible command

Code/Name	Range (unit)	Initial value
<b>oJ-21</b> Writing register 1, Gr.B	0000 to FFFF	0000
<b>oJ-22</b> Writing register 2, Gr.B	0000 to FFFF	0000
<b>oJ-23</b> Writing register 3, Gr.B	0000 to FFFF	0000
<b>oJ-24</b> Writing register 4, Gr.B	0000 to FFFF	0000
<b>oJ-25</b> Writing register 5, Gr.B	0000 to FFFF	0000
<b>oJ-26</b> Writing register 6, Gr.B	0000 to FFFF	0000
<b>oJ-27</b> Writing register 7, Gr.B	0000 to FFFF	0000
<b>oJ-28</b> Writing register 8, Gr.B	0000 to FFFF	0000
<b>oJ-29</b> Writing register 9, Gr.B	0000 to FFFF	0000
<b>oJ-30</b> Writing register 10, Gr.B	0000 to FFFF	0000
<b>oJ-31</b> Reading register 1 Gr.B	0000 to FFFF	0000
<b>oJ-32</b> Reading register 2 Gr.B	0000 to FFFF	0000
<b>oJ-33</b> Reading register 3 Gr.B	0000 to FFFF	0000
<b>oJ-34</b> Reading register 4 Gr.B	0000 to FFFF	0000
<b>oJ-35</b> Reading register 5 Gr.B	0000 to FFFF	0000
<b>oJ-36</b> Reading register 6 Gr.B	0000 to FFFF	0000
<b>oJ-37</b> Reading register 7 Gr.B	0000 to FFFF	0000
<b>oJ-38</b> Reading register 8 Gr.B	0000 to FFFF	0000
<b>oJ-39</b> Reading register 9 Gr.B	0000 to FFFF	0000
<b>oJ-40</b> Reading register 10 Gr.B	0000 to FFFF	0000

- Refer to the Option User's Guide for more details.

**[oJ-41] to [oJ-60]**

- Group C option I/F flexible command

Code/Name	Range (unit)	Initial value
<b>oJ-41</b> Writing register 1, Gr.C	0000 to FFFF	0000
<b>oJ-42</b> Writing register 2, Gr.C	0000 to FFFF	0000
<b>oJ-43</b> Writing register 3, Gr.C	0000 to FFFF	0000
<b>oJ-44</b> Writing register 4, Gr.C	0000 to FFFF	0000
<b>oJ-45</b> Writing register 5, Gr.C	0000 to FFFF	0000
<b>oJ-46</b> Writing register 6, Gr.C	0000 to FFFF	0000
<b>oJ-47</b> Writing register 7, Gr.C	0000 to FFFF	0000
<b>oJ-48</b> Writing register 8, Gr.C	0000 to FFFF	0000
<b>oJ-49</b> Writing register 9, Gr.C	0000 to FFFF	0000
<b>oJ-50</b> Writing register 10, Gr.C	0000 to FFFF	0000
<b>oJ-51</b> Reading register 1 Gr.C	0000 to FFFF	0000
<b>oJ-52</b> Reading register 2 Gr.C	0000 to FFFF	0000
<b>oJ-53</b> Reading register 3 Gr.C	0000 to FFFF	0000
<b>oJ-54</b> Reading register 4 Gr.C	0000 to FFFF	0000
<b>oJ-55</b> Reading register 5 Gr.C	0000 to FFFF	0000
<b>oJ-56</b> Reading register 6 Gr.C	0000 to FFFF	0000
<b>oJ-57</b> Reading register 7 Gr.C	0000 to FFFF	0000
<b>oJ-58</b> Reading register 8 Gr.C	0000 to FFFF	0000
<b>oJ-59</b> Reading register 9 Gr.C	0000 to FFFF	0000
<b>oJ-60</b> Reading register 10 Gr.C	0000 to FFFF	0000

- Refer to the Option User's Guide for more details.

**[oL-01] to [oL-36]****P1-EN Ethernet communication Option****Group 1 setting**

Code/Name	Range (unit)	Initial value
<b>oL-01</b> IPv4 IP address (1) Gr.1	0 to 255	192
<b>oL-02</b> IPv4 IP address (2) Gr.1	0 to 255	168
<b>oL-03</b> IPv4 IP address (3) Gr.1	0 to 255	0
<b>oL-04</b> IPv4 IP address (4) Gr.1	0 to 255	2
<b>oL-05</b> IPv4 subnet mask (1) Gr.1	0 to 255	255
<b>oL-06</b> IPv4 subnet mask (2) Gr.1	0 to 255	255
<b>oL-07</b> IPv4 subnet mask (3) Gr.1	0 to 255	255
<b>oL-08</b> IPv4 subnet mask (4) Gr.1	0 to 255	0
<b>oL-09</b> IPv4 default gateway (1) Gr.1	0 to 255	192
<b>oL-10</b> IPv4 default gateway (2) Gr.1	0 to 255	168
<b>oL-11</b> IPv4 default gateway (3) Gr.1	0 to 255	0
<b>oL-12</b> IPv4 default gateway (4) Gr.1	0 to 255	1
<b>oL-20</b> IPv6 IP address (1) Gr.1	0000 to FFFF	0000
<b>oL-21</b> IPv6 IP address (2) Gr.1	0000 to FFFF	0000
<b>oL-22</b> IPv6 IP address (3) Gr.1	0000 to FFFF	0000
<b>oL-23</b> IPv6 IP address (4) Gr.1	0000 to FFFF	0000
<b>oL-24</b> IPv6 IP address (5) Gr.1	0000 to FFFF	0000
<b>oL-25</b> IPv6 IP address (6) Gr.1	0000 to FFFF	0000
<b>oL-26</b> IPv6 IP address (7) Gr.1	0000 to FFFF	0000
<b>oL-27</b> IPv6 IP address (8) Gr.1	0000 to FFFF	0000
<b>oL-28</b> IPv6 Prefix of subnet, Gr.1	0 to 127	64
<b>oL-29</b> IPv6 default gateway (1) Gr.1	0000 to FFFF	0000
<b>oL-30</b> IPv6 default gateway (2) Gr.1	0000 to FFFF	0000
<b>oL-31</b> IPv6 default gateway (3) Gr.1	0000 to FFFF	0000
<b>oL-32</b> IPv6 default gateway (4) Gr.1	0000 to FFFF	0000
<b>oL-33</b> IPv6 default gateway (5) Gr.1	0000 to FFFF	0000
<b>oL-34</b> IPv6 default gateway (6) Gr.1	0000 to FFFF	0000
<b>oL-35</b> IPv6 default gateway (7) Gr.1	0000 to FFFF	0000
<b>oL-36</b> IPv6 default gateway (8) Gr.1	0000 to FFFF	0000

• Refer to the Option User's Guide for more details.

**[oL-40] to [oL-76]****P1-EN Ethernet communication Option****Group 2 setting**

Code/Name	Range (unit)	Initial value
<b>oL-40</b> IPv4 IP-address (1) Gr.2	0 to 255	192
<b>oL-41</b> IPv4 IP-address (2) Gr.2	0 to 255	168
<b>oL-42</b> IPv4 IP-address (3) Gr.2	0 to 255	0
<b>oL-43</b> IPv4 IP-address (4) Gr.2	0 to 255	2
<b>oL-44</b> IPv4 subnet mask (1) Gr.2	0 to 255	255
<b>oL-45</b> IPv4 subnet mask (2) Gr.2	0 to 255	255
<b>oL-46</b> IPv4 subnet mask (3) Gr.2	0 to 255	255
<b>oL-47</b> IPv4 subnet mask (4) Gr.2	0 to 255	0
<b>oL-48</b> IPv4 default gateway (1) Gr.2	0 to 255	192
<b>oL-49</b> IPv4 default gateway (2) Gr.2	0 to 255	168
<b>oL-50</b> IPv4 default gateway (3) Gr.2	0 to 255	0
<b>oL-51</b> IPv4 default gateway (4) Gr.2	0 to 255	1
<b>oL-60</b> IPv6 IP address (1) Gr.2	0000 to FFFF	0000
<b>oL-61</b> IPv6 IP address (2) Gr.2	0000 to FFFF	0000
<b>oL-62</b> IPv6 IP address (3) Gr.2	0000 to FFFF	0000
<b>oL-63</b> IPv6 IP address (4) Gr.2	0000 to FFFF	0000
<b>oL-64</b> IPv6 IP address (5) Gr.2	0000 to FFFF	0000
<b>oL-65</b> IPv6 IP address (6) Gr.2	0000 to FFFF	0000
<b>oL-66</b> IPv6 IP address (7) Gr.2	0000 to FFFF	0000
<b>oL-67</b> IPv6 IP address (8) Gr.2	0000 to FFFF	0000
<b>oL-68</b> IPv6 Prefix of subnet, Gr.2	0 to 127	64
<b>oL-69</b> IPv6 default gateway (1) Gr.2	0000 to FFFF	0000
<b>oL-70</b> IPv6 default gateway (2) Gr.2	0000 to FFFF	0000
<b>oL-71</b> IPv6 default gateway (3) Gr.2	0000 to FFFF	0000
<b>oL-72</b> IPv6 default gateway (4) Gr.2	0000 to FFFF	0000
<b>oL-73</b> IPv6 default gateway (5) Gr.2	0000 to FFFF	0000
<b>oL-74</b> IPv6 default gateway (6) Gr.2	0000 to FFFF	0000
<b>oL-75</b> IPv6 default gateway (7) Gr.2	0000 to FFFF	0000
<b>oL-76</b> IPv6 default gateway (8) Gr.2	0000 to FFFF	0000

• Refer to the Option User's Guide for more details.

## [PA-01] to [PA-05]

■ Parameter mode (P code)

## Em-force mode setting

Code/Name	Range (unit)	Initial value
<b>PA-01</b> Enable Emergency-force drive mode	00(Disable)/ 01(Enable)	00
<b>PA-02</b> Emergency-force drive frequency reference	0.00 to 590.00(Hz) *1)	0.00
<b>PA-03</b> Emergency-force drive direction command	00(Forward)/ 01(Reverse)	00
<b>PA-04</b> Commercial power supply bypass function selection	00(Disable)/ 01(Enable)	00
<b>PA-05</b> Commercial power supply bypass function delay time	0.0 to 1000.0(s)	5.0

\*1) The actual setting range is limited to the maximum frequency setting ([Hb105/205] [Hd105/205])

- Above parameters set the behavior of the EM-force mode when an error occurs.
- Enable Emergency-force drive mode [PA-01] is set to 01(Enable) and input terminal 105[EMF] is turned on, the forced operation mode is executed.  
The output terminal 076[EMFC] turns on during the Em-force drive mode.
- When [PA-04] is set to 01 (enabled), it is possible to switch to the commercial power operation mode (bypass mode) when the specified operation is not able to be changed during forced operation. In bypass mode, the output terminal 077 [EMBP] signal in bypass mode is ON and the inverter output is cut off.  
For more information, refer to the P1 user's guide.

## [PA-20] to [PA-31]

## Simulation mode setting

Code/Name	Range (unit)	Initial value
<b>PA-20</b> Simulation mode enable	00(Disable)/01(Enable)	00
<b>PA-21</b> Error code selection for alarm test	0 to 255	0
<b>PA-22</b> Simulation mode: Optional output selection for the output current monitor	00(Disable)/ 01(Parameter[PA-23])/ 02(Setting by terminal [Ai1])/ 03(Setting by terminal [Ai2])/ 04(Setting by terminal [Ai3])/ 05(Setting by terminal [Ai4])/ 06(Setting by terminal [Ai5])/ 07(Setting by terminal [Ai6])	01
<b>PA-23</b> Optional output value setting for the output current monitor	0.0 to Inverter rated current × 3.0(A)	0.0
<b>PA-24</b> Simulation mode: Optional output selection for the DC bus voltage monitor	00(Disable)/ 01(Parameter[PA-25])/ 02(Setting by terminal [Ai1])/ 03(Setting by terminal [Ai2])/ 04(Setting by terminal [Ai3])/ 05(Setting by terminal [Ai4])/ 06(Setting by terminal [Ai5])/ 07(Setting by terminal [Ai6])	01
<b>PA-25</b> Optional output value setting for the DC bus voltage monitor	200V Class: 0.0 to 450.0(VDC) 400V Class: 0.0 to 900.0(VDC)	200V: 270.0 400V: 540.0
<b>PA-26</b> Simulation mode: Optional output selection for the output voltage monitor	00(Disable)/ 01(Parameter[PA-27])/ 02(Setting by terminal [Ai1])/ 03(Setting by terminal [Ai2])/ 04(Setting by terminal [Ai3])/ 05(Setting by terminal [Ai4])/ 06(Setting by terminal [Ai5])/ 07(Setting by terminal [Ai6])	01
<b>PA-27</b> Optional output value setting for the output voltage monitor	200V Class: 0.0 to 300.0(V) 400V Class: 0.0 to 600.0(V)	0.0
<b>PA-28</b> Simulation mode: Optional output selection for the output torque monitor	00(Disable)/ 01(Parameter[PA-29])/ 02(Setting by terminal [Ai1])/ 03(Setting by terminal [Ai2])/ 04(Setting by terminal [Ai3])/ 05(Setting by terminal [Ai4])/ 06(Setting by terminal [Ai5])/ 07(Setting by terminal [Ai6])	01
<b>PA-29</b> Optional output value setting for the output torque monitor	-500.0 to 500.0(%)	0.0
<b>PA-30</b> Simulation mode: Optional frequency matching start enable setting	00(Disable)/ 01(Parameter[PA-31])/ 02(Setting by terminal [Ai1])/ 03(Setting by terminal [Ai2])/ 04(Setting by terminal [Ai3])/ 05(Setting by terminal [Ai4])/ 06(Setting by terminal [Ai5])/ 07(Setting by terminal [Ai6])	01
<b>PA-31</b> Optional frequency matching start setting value	0.0 to 590.0(Hz)	0.0

- Above parameters set the simulation mode functions.  
For more information, refer to the P1 user's guide.



[UA-01] to [UA-19]

■ Parameter mode (U code)

**Password setting**

Code/Name	Range (unit)	Initial value
<b>UA-01</b> Password for display(UA-10)	0000 to FFFF	0000
<b>UA-02</b> Password for softlock(UA-16)	0000 to FFFF	0000

- If the password other than 0000 is set to [UA-01]/[UA-02], the parameter [UA-10]/[UA-16] are locked and cannot be changed. When the password is set for [UA-01]/[UA-02] again, the locked state is released.
- For password setting, be sure to refer to the P1 User's Guide and fully understand and use it. Please note that if you forget the password, locked state cannot release !

**Keypad display mode**

Code/Name	Range (unit)	Initial value
<b>UA-10</b> Display restriction selection	00(Full display)/ 01(Function-specific display)/ 02(User setting)/ 03(Data comparison display)/ 04(Monitor only)	00

- This parameter selects the display mode of the keypad.
- For more information, refer to the P1 User's guide.

**Accumulated power display adjustment/clear**

Code/Name	Range (unit)	Initial value
<b>UA-12</b> Accumulated input power monitor clear	00(Disable)/ 01(Clear)	00
<b>UA-13</b> Display gain for the accumulated input power monitor	1 to 1000	1
<b>UA-14</b> Accumulated output power monitor clear	00(Disable)/ 01(Clear)	00
<b>UA-15</b> Display gain for the accumulated output power monitor	1 to 1000	1

- If input terminal 039[KHC] is turned ON, the accumulated input power can be clear.
- If input terminal 040[OKHC] is turned ON, the accumulated output power can be clear.

**Software lock operation setting**

Code/Name	Range (unit)	Initial value
<b>UA-16</b> Soft-Lock selection	00([SFT] terminal)/ 01(Always enable)	00
<b>UA-17</b> Soft-Lock target selection	00(All data)/ 01(All, except speed related values)	00

- Above parameters set the software lock operation.

**Keypad copy function restriction**

Code/Name	Range (unit)	Initial value
<b>UA-18</b> Data R/W selection	00(Enable R/W by operator) 01(Disable R/W by operator)	00

- This parameter restricts the copy function of the keypad( Read/Write function of VOP).

**Keypad low battery warning**

Code/Name	Range (unit)	Initial value
<b>UA-19</b> Low battery warning enable	00(Disable)/ 01(Warning [LBK] )/ 02(Error[E042])	00

- This parameter sets the behavior when the keypad battery is low.

[UA-20] to [UA-62]

**Keypad communication lost operation**

Code/Name	Range (unit)	Initial value
<b>UA-20</b> Action selection at keypad disconnection	00(Error)/ 01(Error output after deceleration stop)/ 02(Ignore)/03(Free run stop)/ 04(Deceleration stop)	02

**2<sup>nd</sup>-motor/option parameter display selection**

Code/Name	Range (unit)	Initial value
<b>UA-21</b> 2nd-motor parameter display selection	00(Hidden)/01(Display)	01
<b>UA-22</b> Option parameter display selection	00(Hidden)/01(Display)	01

- If options and 2nd-motor are not used, it is recommended to hide their parameters.  
For more information, refer to the P1 User's guide.

**User-parameter setting function**

Code/Name	Range (unit)	Initial value
<b>UA-30</b> User-parameter auto setting function enable	00(Disable)/ 01(Enable)	00
<b>UA-31</b> User-parameter 1 selection	no/ (Parameters excluding [UA-31] to [UA-62])	no
<b>UA-32</b> User-parameter 2 selection		no
<b>UA-33</b> User-parameter 3 selection		no
<b>UA-34</b> User-parameter 4 selection		no
<b>UA-35</b> User-parameter 5 selection		no
<b>UA-36</b> User-parameter 6 selection		no
<b>UA-37</b> User-parameter 7 selection		no
<b>UA-38</b> User-parameter 8 selection		no
<b>UA-39</b> User-parameter 9 selection		no
<b>UA-40</b> User-parameter 10 selection		no
<b>UA-41</b> User-parameter 11 selection		no
<b>UA-42</b> User-parameter 12 selection		no
<b>UA-43</b> User-parameter 13 selection		no
<b>UA-44</b> User-parameter 14 selection		no
<b>UA-45</b> User-parameter 15 selection		no
<b>UA-46</b> User-parameter 16 selection		no
<b>UA-47</b> User-parameter 17 selection		no
<b>UA-48</b> User-parameter 18 selection		no
<b>UA-49</b> User-parameter 19 selection		no
<b>UA-50</b> User-parameter 20 selection		no
<b>UA-51</b> User-parameter 21 selection		no
<b>UA-52</b> User-parameter 22 selection		no
<b>UA-53</b> User-parameter 23 selection		no
<b>UA-54</b> User-parameter 24 selection		no
<b>UA-55</b> User-parameter 25 selection		no
<b>UA-56</b> User-parameter 26 selection		no
<b>UA-57</b> User-parameter 27 selection		no
<b>UA-58</b> User-parameter 28 selection		no
<b>UA-59</b> User-parameter 29 selection		no
<b>UA-60</b> User-parameter 30 selection		no
<b>UA-61</b> User-parameter 31 selection		no
<b>UA-62</b> User-parameter 32 selection		no

- Above parameters store the changed parameters history in [UA-31] to [UA-62] when [UA-30] = 01, or set the data to be displayed when [UA-10] = 02. ([UA-10] = 02 setting is priority)

[UA-90] to [UA-94][Ub-01] to [Ub-05]

[Ud-01] to [Ud-37]

**MOP keypad setting**

Code/Name	Range (unit)	Initial value
<b>UA-90</b> Waiting time for turning off the display(MOP)	0 to 60(min)	0
<b>UA-91</b> Initial display selection (MOP)	(Select from d----, F---- parameters)	dA-01
<b>UA-92</b> Enable auto-return to the initial display (MOP)	00(Disable)/ 01(Enable)	00
<b>UA-93</b> Enable frequency changes through monitor display(MOP)	00(Disable)/ 01(Enable)	00
<b>UA-94</b> Enable multi-speed frequency changes through monitor display (MOP)	00(Disable)/ 01(Enable)	00

- Above parameters set the behavior of the MOP keypad.

**Initialize**

Code/Name	Range (unit)	Initial value
<b>Ub-01</b> Initialize mode selection	00(Disable)/ 01(Error history clear)/ 02(Data initialize)/ 03(Error history clear & Data initialize)/ 04(Error history clear & Data initialize & EzSQ clear)/ 05(All data except terminal configuration)/ 06(All data except communication configuration)/ 07(All data except terminal & communication configuration)/ 08(EzSQ only)	00
<b>Ub-02</b> Initialize data selection	00(JP)/01(EU)/ 02(US)/03(CHN)	00(JPN) 01(EU) 02(USA) 03(CHN)
<b>Ub-03</b> Load type selection	00(Very Low Duty)/ 01(Low Duty)/ 02(Normal Duty)	02
<b>Ub-05</b> Enable initialization	00(Disable)/ 01(Execute initialization)	00

- How to initialize; at first select the initial mode at [Ub-01], next, when [Ub-05] is set to 1, initialize process is start.
- Once setting the load type selection [Ub-03], the inverter load rating will be changed instantaneously.
- P1-05500-H(P1-2500H) and P1-06600-H(P1-3150H) support only normal duty(ND) and low duty (LD). Even if Very low duty(VLD) is selected for these models, it is processed as low duty(LD).

**Factory setting**

Code/Name	Range (unit)	Initial value
<b>UC-01</b> (-)	(Do not change)	(00)

**Trace function**

Code/Name	Range (unit)	Initial value
<b>Ud-01</b> Trace function enable	00(Disable)/01(Enable)	00
<b>Ud-02</b> Trace start *1)	00(Stop)/01(Start)	00
<b>Ud-03</b> Number of trace data setting	0 to 8	1
<b>Ud-04</b> Number of trace signals setting	0 to 8	1
<b>Ud-10</b> Trace data 0 selection	(parameters of the d**** and F**** mode)	dA-01
<b>Ud-11</b> Trace data 1 selection		dA-01
<b>Ud-12</b> Trace data 2 selection		dA-01
<b>Ud-13</b> Trace data 3 selection		dA-01
<b>Ud-14</b> Trace data 4 selection		dA-01
<b>Ud-15</b> Trace data 5 selection		dA-01
<b>Ud-16</b> Trace data 6 selection		dA-01
<b>Ud-17</b> Trace data 7 selection		dA-01
<b>Ud-20</b> Trace signal 0 input/output selection	00(Input:[Ud-21])/01(Output:[Ud-22])	00
<b>Ud-21</b> Trace signal 0 input terminal selection	Same as [CA-01]	001
<b>Ud-22</b> Trace signal 0 output terminal selection	Same as [CC-01]	001
<b>Ud-23</b> Trace signal 1 input/output selection	00(Input:[Ud-24])/01(Output:[Ud-25])	00
<b>Ud-24</b> Trace signal 1 input terminal selection	Same as [CA-01]	001
<b>Ud-25</b> Trace signal 1 output terminal selection	Same as [CC-01]	001
<b>Ud-26</b> Trace signal 2 input/output selection	00(Input:[Ud-27])/01(Output:[Ud-28])	00
<b>Ud-27</b> Trace signal 2 input terminal selection	Same as [CA-01]	001
<b>Ud-28</b> Trace signal 2 output terminal selection	Same as [CC-01]	001
<b>Ud-29</b> Trace signal 3 input/output selection	00(Input:[Ud-30])/01(Output:[Ud-31])	00
<b>Ud-30</b> Trace signal 3 input terminal selection	Same as [CA-01]	001
<b>Ud-31</b> Trace signal 3 output terminal selection	Same as [CC-01]	001
<b>Ud-32</b> Trace signal 4 input/output selection	00(Input:[Ud-33])/01(Output:[Ud-34])	00
<b>Ud-33</b> Trace signal 4 input terminal selection	Same as [CA-01]	001
<b>Ud-34</b> Trace signal 4 output terminal selection	Same as [CC-01]	001
<b>Ud-35</b> Trace signal 5 input/output selection	00(Input:[Ud-36])/01(Output:[Ud-37])	00
<b>Ud-36</b> Trace signal 5 input terminal selection	Same as [CA-01]	001
<b>Ud-37</b> Trace signal 5 output terminal selection	Same as [CC-01]	001

\*1) Trace start is also possible from ON of input terminal 108[DTR] or from ProDriveNext. And while the inverter is in trace function, the output terminal 079[TRA] turns ON.

For more information, refer to the P1 User's guide and the PC setting software ProDriveNext's instruction manual(NT8001\*X)

## [Ud-38] to [Ud-60]

## Trace function

Code/Name	Range (unit)	Initial value
<b>Ud-38</b> Trace signal 6 input/output selection	00 (Input: [Ud-39])/01 (Output: [Ud-40])	00
<b>Ud-39</b> Trace signal 6 input terminal selection	Similar to [CA-01]	001
<b>Ud-40</b> Trace signal 6 output terminal selection	Similar to [CC-01]	001
<b>Ud-41</b> Trace signal 7 input/output selection	00 (Input: [Ud-42])/01 (Output: [Ud-43])	00
<b>Ud-42</b> Trace signal 7 input terminal selection	Similar to [CA-01]	001
<b>Ud-43</b> Trace signal 7 output terminal selection	Similar to [CC-01]	001
<b>Ud-50</b> Trace trigger 1 selection	00(Trip)/01(Data 0)/02(Data 1)/03(Data 2)/04(Data 3)/05(Data 4)/06(Data 5)/07(Data 6)/08(Data 7)/09(Signal 0)/10(Signal 1)/11(Signal 2)/12(Signal 3)/13(Signal 4)/14(Signal 5)/15(Signal 6)/16(Signal 7)	00
<b>Ud-51</b> Trigger 1 activation selection at trace data trigger	00(Action at rising above the trigger level)/01(Action at falling below the trigger level)	00
<b>Ud-52</b> Trigger 1 level setting at trace data trigger	0 to 100(%)	0
<b>Ud-53</b> Trigger 1 activation selection at trace signal trigger	00(Action by signal on)/01(Action by signal off)	00
<b>Ud-54</b> Trace trigger 2 selection	00(Trip)/01(Data 0)/02(Data 1)/03(Data 2)/04(Data 3)/05(Data 4)/06(Data 5)/07(Data 6)/08(Data 7)/09(Signal 0)/10(Signal 1)/11(Signal 2)/12(Signal 3)/13(Signal 4)/14(Signal 5)/15(Signal 6)/16(Signal 7)	00
<b>Ud-55</b> Trigger 2 activation selection at trace data trigger	00(Action at rising above the trigger level)/01(Action at falling below the trigger level)	00
<b>Ud-56</b> Trigger 2 level setting at trace data trigger	0 to 100(%)	0
<b>Ud-57</b> Trigger 2 activation selection at trace signal trigger	00(Action by signal on)/01(Action by signal off)	00
<b>Ud-58</b> Trigger condition selection	00(At trace trigger 1 activation)/01(At trace trigger 2 activation)/02(Trigger-1 OR trigger-2 activation)/03(Trigger-1 AND trigger-2 activation)	00
<b>Ud-59</b> Trigger point setting	0 to 100(%)	0
<b>Ud-60</b> Sampling time setting	01(0.2ms)/02(0.5ms)/03(1ms)/04(2ms)/05(5ms)/06(10ms)/07(50ms)/08(100ms)/09(500ms)/10(1000ms)	03

- For more information, refer to the P1 User's guide and the PC setting software ProDriveNext's instruction manual(NT8001\*X).

## [UE-01] to [UE-48]

## EzSQ (Program operation function)

Code/Name	Range (unit)	Initial value
<b>UE-01</b> EzSQ execution cycle	00(1ms)/01(2ms: SJ700/L700 compatible)	00
<b>UE-02</b> EzSQ enable setting	00(Disable)/01([PRG] terminal)/02(Always enabled)	00

- EzSQ creates a program with inverter setup software ProdriveNext. To operate the EzSQ function, it is necessary to download the program into the inverter.

Code/Name	Range (unit)	Initial value
<b>UE-10</b> EzSQ User parameter U(00)	0 to 65535	0
<b>UE-11</b> EzSQ User parameter U(01)	0 to 65535	0
<b>UE-12</b> EzSQ User parameter U(02)	0 to 65535	0
<b>UE-13</b> EzSQ User parameter U(03)	0 to 65535	0
<b>UE-14</b> EzSQ User parameter U(04)	0 to 65535	0
<b>UE-15</b> EzSQ User parameter U(05)	0 to 65535	0
<b>UE-16</b> EzSQ User parameter U(06)	0 to 65535	0
<b>UE-17</b> EzSQ User parameter U(07)	0 to 65535	0
<b>UE-18</b> EzSQ User parameter U(08)	0 to 65535	0
<b>UE-19</b> EzSQ User parameter U(09)	0 to 65535	0
<b>UE-20</b> EzSQ User parameter U(10)	0 to 65535	0
<b>UE-21</b> EzSQ User parameter U(11)	0 to 65535	0
<b>UE-22</b> EzSQ User parameter U(12)	0 to 65535	0
<b>UE-23</b> EzSQ User parameter U(13)	0 to 65535	0
<b>UE-24</b> EzSQ User parameter U(14)	0 to 65535	0
<b>UE-25</b> EzSQ User parameter U(15)	0 to 65535	0
<b>UE-26</b> EzSQ User parameter U(16)	0 to 65535	0
<b>UE-27</b> EzSQ User parameter U(17)	0 to 65535	0
<b>UE-28</b> EzSQ User parameter U(18)	0 to 65535	0
<b>UE-29</b> EzSQ User parameter U(19)	0 to 65535	0
<b>UE-30</b> EzSQ User parameter U(20)	0 to 65535	0
<b>UE-31</b> EzSQ User parameter U(21)	0 to 65535	0
<b>UE-32</b> EzSQ User parameter U(22)	0 to 65535	0
<b>UE-33</b> EzSQ User parameter U(23)	0 to 65535	0
<b>UE-34</b> EzSQ User parameter U(24)	0 to 65535	0
<b>UE-35</b> EzSQ User parameter U(25)	0 to 65535	0
<b>UE-36</b> EzSQ User parameter U(26)	0 to 65535	0
<b>UE-37</b> EzSQ User parameter U(27)	0 to 65535	0
<b>UE-38</b> EzSQ User parameter U(28)	0 to 65535	0
<b>UE-39</b> EzSQ User parameter U(29)	0 to 65535	0
<b>UE-40</b> EzSQ User parameter U(30)	0 to 65535	0
<b>UE-41</b> EzSQ User parameter U(31)	0 to 65535	0
<b>UE-42</b> EzSQ User parameter U(32)	0 to 65535	0
<b>UE-43</b> EzSQ User parameter U(33)	0 to 65535	0
<b>UE-44</b> EzSQ User parameter U(34)	0 to 65535	0
<b>UE-45</b> EzSQ User parameter U(35)	0 to 65535	0
<b>UE-46</b> EzSQ User parameter U(36)	0 to 65535	0
<b>UE-47</b> EzSQ User parameter U(37)	0 to 65535	0
<b>UE-48</b> EzSQ User parameter U(38)	0 to 65535	0

## [UE-49] to [UE-73][UF-02] to [UF-32]

Code/Name	Range (unit)	Initial value
<b>UE-49</b> EzSQ User parameter U(39)	0 to 65535	0
<b>UE-50</b> EzSQ User parameter U(40)	0 to 65535	0
<b>UE-51</b> EzSQ User parameter U(41)	0 to 65535	0
<b>UE-52</b> EzSQ User parameter U(42)	0 to 65535	0
<b>UE-53</b> EzSQ User parameter U(43)	0 to 65535	0
<b>UE-54</b> EzSQ User parameter U(44)	0 to 65535	0
<b>UE-55</b> EzSQ User parameter U(45)	0 to 65535	0
<b>UE-56</b> EzSQ User parameter U(46)	0 to 65535	0
<b>UE-57</b> EzSQ User parameter U(47)	0 to 65535	0
<b>UE-58</b> EzSQ User parameter U(48)	0 to 65535	0
<b>UE-59</b> EzSQ User parameter U(49)	0 to 65535	0
<b>UE-60</b> EzSQ User parameter U(50)	0 to 65535	0
<b>UE-61</b> EzSQ User parameter U(51)	0 to 65535	0
<b>UE-62</b> EzSQ User parameter U(52)	0 to 65535	0
<b>UE-63</b> EzSQ User parameter U(53)	0 to 65535	0
<b>UE-64</b> EzSQ User parameter U(54)	0 to 65535	0
<b>UE-65</b> EzSQ User parameter U(55)	0 to 65535	0
<b>UE-66</b> EzSQ User parameter U(56)	0 to 65535	0
<b>UE-67</b> EzSQ User parameter U(57)	0 to 65535	0
<b>UE-68</b> EzSQ User parameter U(58)	0 to 65535	0
<b>UE-69</b> EzSQ User parameter U(59)	0 to 65535	0
<b>UE-70</b> EzSQ User parameter U(60)	0 to 65535	0
<b>UE-71</b> EzSQ User parameter U(61)	0 to 65535	0
<b>UE-72</b> EzSQ User parameter U(62)	0 to 65535	0
<b>UE-73</b> EzSQ User parameter U(63)	0 to 65535	0

• EzSQ up to 16 bits data can be set.

Code/Name	Range (unit)	Initial value
<b>UF-02</b> EzSQ User parameter UL(00)	-2147483647 to 2147483647	0
<b>UF-04</b> EzSQ User parameter UL(01)	-2147483647 to 2147483647	0
<b>UF-06</b> EzSQ User parameter UL(02)	-2147483647 to 2147483647	0
<b>UF-08</b> EzSQ User parameter UL(03)	-2147483647 to 2147483647	0
<b>UF-10</b> EzSQ User parameter UL(04)	-2147483647 to 2147483647	0
<b>UF-12</b> EzSQ User parameter UL(05)	-2147483647 to 2147483647	0
<b>UF-14</b> EzSQ User parameter UL(06)	-2147483647 to 2147483647	0
<b>UF-16</b> EzSQ User parameter UL(07)	-2147483647 to 2147483647	0
<b>UF-18</b> EzSQ User parameter UL(08)	-2147483647 to 2147483647	0
<b>UF-20</b> EzSQ User parameter UL(09)	-2147483647 to 2147483647	0
<b>UF-22</b> EzSQ User parameter UL(10)	-2147483647 to 2147483647	0
<b>UF-24</b> EzSQ User parameter UL(11)	-2147483647 to 2147483647	0
<b>UF-26</b> EzSQ User parameter UL(12)	-2147483647 to 2147483647	0
<b>UF-28</b> EzSQ User parameter UL(13)	-2147483647 to 2147483647	0
<b>UF-30</b> EzSQ User parameter UL(14)	-2147483647 to 2147483647	0
<b>UF-32</b> EzSQ User parameter UL(15)	-2147483647 to 2147483647	0

• EzSQ up to 32 bits data can be set.

## [Unit table]

Number	Unit
00	Non
01	%
02	A
03	Hz
04	V
05	kW
06	W
07	hr
08	S
09	kHz
10	ohm
11	mA
12	ms
13	P
14	kgm2
15	pls
16	mH
17	Vdc
18	°C
19	kWh
20	mF
21	mVs/rad
22	Nm
23	min-1
24	m/s
25	m/min
26	m/h
27	ft/s
28	ft/min
29	ft/h
30	m

Number	Unit
31	cm
32	°F
33	l/s
34	l/min
35	l/h
36	m3/s
37	m3/min
38	m3/h
39	kg/s
40	kg/min
41	kg/h
42	t/min
43	t/h
44	gal/s
45	gal/min
46	gal/h
47	ft3/s
48	ft3/min
49	ft3/h
50	lb/s
51	lb/min
52	lb/h
53	mbar
54	bar
55	Pa
56	kPa
57	PSI
58	mm

# Chapter 5 FAQ/Troubleshooting

## 5.1 Error events

Next are the descriptions of the basic errors that may occur. For more information, refer to the user's guide.

### ■ Trip event screen

Detailed information screen of the occurred trip

The error code (E001 as example) is explained further ahead. With the ▼ key, you can scroll the screen. For more information, refer to the user's guide.

Some inverter status when an error occurs (The latest 10 times are memorized)

Statuses at which the trip event may have happened  
 State 1: Inverter operation status  
 State 2: LAD(Accel/Decel) operation status  
 State 3: Inverter control status  
 State 4: Motor drive limit status  
 State 5: Special feature operation status

### ■ Action when an error occurs

Code	Details	Corrective actions	Related parameter
E001	By the load or the operating conditions, overcurrent has occurred.	• If the acceleration is fast, increase the acceleration time.	[AC120]
		• Use the overcurrent suppression function.	[bA120]
		• Use the overload restriction function.	[bA122]
		• Use the overcurrent retry function.	[bb-22]
		• In order to stabilize the control, Try auto-tuning for motor constants.	[HA-01]
E005 E039	By the load and the operating conditions, current has increased.	• If the acceleration is fast, increase the acceleration time.	[AC120]
		• Use the overload restriction function.	[bA122]
		• If the motor sound is abnormal, in order to stabilize the control, adjust the motor constant by trying auto-tuning.	[HA-01]
E006	Braking resistor use is limited.	• If the deceleration is fast, increase the deceleration time.	[AC122]
		• Reselection of the braking resistor is necessary.	[bA-60]
E007	The inverter's P-N voltage has increased due to the regenerative voltage during sudden deceleration and lowering of the motor.	• If the deceleration is fast, increase the deceleration time.	[AC122]
		• Use the overvoltage suppression functions.	[bA140][bA146]
		• Use the overvoltage retry function.	[bb-23]
		• Use the regenerative braking option.	-
E008 E011 *1)	Main CPU abnormality.	• Carry out counter measures for the inverter noise.	-
		• If it occurs consecutively, there is a possibility of inverter failure.	-
E009	Main circuit supply has drop.	• To disable the under-voltage error, change setting.	[bb-27]
		• Use the under-voltage retry function	[bb-21]
E010 *1)	Current detector abnormality.	• Carry out counter measures for the inverter noise	-
		• If it occurs consecutively, there is a possibility of inverter failure, and parts replacement might be required.	-
E012	Input terminal 033[EXT] is ON.	• Check the signal status of the input terminal	[dA-51]
		• Check if there are no operations by communication or EzSQ program.	-
E013	While the input terminal 034[USP] was ON and the RUN command is input state, the main power supply was turned ON.	• Make sure that an RUN command is not introduced at the time of turning ON the inverter	[dA-51]
E014 *1)	Ground fault is detected at main power supply turned ON.	• Check insulation deterioration and ground fault of the motor, the wiring and etc..	-
E015	The main power supply voltage has been continuously above the limit.	• Review the power circumstances, such as the power supply capacity.	[dA-40]
E016	The control circuit power supply was off due to instantaneous power supply failure.	• If avoiding this trip is required, use the power loss retry function.	[bb-20]

\*1) As a major failure error, the output terminal function [MJA] turns ON. And these errors could not be canceled with input terminal 028[RS].

Code	Details	Corrective actions	Related parameter
E019 *1)	Abnormality in temperature detector circuit.	<ul style="list-style-type: none"> <li>Carry out counter measures for the inverter noise</li> <li>If it occurs consecutively, there is a possibility of inverter failure.</li> </ul>	-
E020 *1)	The internal temperature of the inverter is rising because the rotational speed of the cooling fan is reduced and the cooling is insufficient.	<ul style="list-style-type: none"> <li>If there is any foreign matter, it may be recovered by removing it.</li> <li>The cooling fan is reached its lifetime, and it is needed replacement.</li> <li>Lower the carrier frequency.</li> </ul>	[bb101]
E021	Internal temperature has increased.	<ul style="list-style-type: none"> <li>Requires a review of the installation circumstances.</li> <li>Due to clogging or life of the cooling fan, The cooling fan may not be operating normally.</li> <li>Lower the carrier frequency.</li> </ul>	[bb101]
E024	Disconnection of the wiring of the main power supply side has occurred.	<ul style="list-style-type: none"> <li>Check the fastening of the input wiring with screws.</li> <li>Check that the 3 phases are correctly inserted.</li> </ul>	-
E030	Sudden increase of current.	<ul style="list-style-type: none"> <li>Verify if a ground fault or a cable disconnection/rupture has occurred at the output wiring. (possible short circuit)</li> <li>Check that the motor is not locked.</li> </ul>	-
E034	Disconnection of the wiring in the motor side has occurred.	<ul style="list-style-type: none"> <li>Check the output wiring disconnection, motor insulation failure, ...etc.</li> <li>Check that the 3 phases are correctly connected.</li> </ul>	-
E035	Abnormal motor temperature.	<ul style="list-style-type: none"> <li>Improve the motor cooling circumstances.</li> <li>Use the overload restriction function.</li> </ul>	[bA122]
	Thermistor abnormality.	<ul style="list-style-type: none"> <li>Check if the thermistor is damaged.</li> <li>Check the thermistor settings.</li> </ul>	[Cb-40]
E036	Brake abnormality.	<ul style="list-style-type: none"> <li>Check if the brake is damaged and if the wiring for the [BOK] signal is disconnected.</li> </ul>	[dA-51]
		<ul style="list-style-type: none"> <li>Check the brake waiting time.</li> </ul>	[AF134][AF141]
E038	Increase of current during slow speed operation.	<ul style="list-style-type: none"> <li>If torque is needed during slow speed, a review of the inverter capacity is necessary.</li> </ul>	-
E040	Keypad disconnection error	<ul style="list-style-type: none"> <li>Check for the disconnection of the keypad VOP from the inverter.</li> </ul>	[UA-20]
		<ul style="list-style-type: none"> <li>Noise counter-measures are necessary</li> </ul>	-
E041	RS485 communication error	<ul style="list-style-type: none"> <li>Noise counter-measures are necessary</li> </ul>	-
		<ul style="list-style-type: none"> <li>Check the communication setting</li> </ul>	[CF-01] to [CF-08]
E042	RTC error	<ul style="list-style-type: none"> <li>Battery replacement for the keypad VOP is necessary</li> </ul>	-
E043 to E045 E050 to E059	There is an error in the EzSQ program.	<ul style="list-style-type: none"> <li>For more information, refer to P1 Easy-Sequence Function(EzSQ) Programming Guide NT252*X.</li> </ul>	-
E060 to E089	There is an error in the option.	<ul style="list-style-type: none"> <li>For more information, refer to each option in user's guide.</li> </ul>	-
1:E090 to E093 2:E094 to E097	1:There is an error in the STO path 2:There is an error in the P1-FS.	<ul style="list-style-type: none"> <li>For more information, refer P1 functional safety guide NT2512*X. Or P1-FS Functional Safety Option Safety Function Guide NT2582*X</li> </ul>	-
E100	A disconnection error of the signal line occurred at P1-FB	<ul style="list-style-type: none"> <li>This error related to the feedback option.</li> <li>For details, refer to P1-FB User's Guide NT253*X</li> </ul>	-
E104	The current position has exceeded the setting range of [AE-52] and [AE-54] in position control.	<ul style="list-style-type: none"> <li>These are errors related to feedback control.</li> <li>Review the operating conditions, check the wiring, encoder settings and other related parameter settings again.</li> <li>Also, refer to related items in P1 User's Guide NT251*X.</li> <li>When using P1-FB, refer to P1-FB User's Guide NT253*X.</li> </ul>	[AE-52] [AE-54]
E105	The speed deviation exceeded "[bb-83] Speed deviation error detection level".		[bb-82] [bb-83]
E106	Position deviation exceeded "[bb-86] Position deviation error detection level".		[bb-86] [bb-87]
E107	The speed has exceeded "[bb-80] Over-speed detection level".		[bb-80] [bb-81]
E110	A contactor error has occurred	<ul style="list-style-type: none"> <li>Re-check [AF120] to [AF123] and wiring etc. of external contactor.</li> </ul>	[AF120] to [AF123]
E112	This error related to the feedback option	<ul style="list-style-type: none"> <li>For details, refer to P1-FB User's Guide NT253*X</li> </ul>	-
E120	This is an error when starting up PID function.	<ul style="list-style-type: none"> <li>Check the wiring and check the parameter settings related to PID soft start such as [AH-76].</li> </ul>	[AH-75] to [AH-82]

\*1) As a major failure error, the output terminal function [MJA] turns ON. And these errors could not be canceled with input terminal 028[RS]. However the E020 error can be reset after the inverter tempratuer drops down.

※For others errors not shown above, refer to the P1 user's guide and other user's guide such as option.

#### ■ Warning events

※Regarding the warnings, refer to the user's guide. Fixing the parameter details shown in the panel screen may cancel the warning.

5.2 Confirming the status

■ Frequently asked questions – FAQ (simplified edition)

· Each part on the screen of keypad

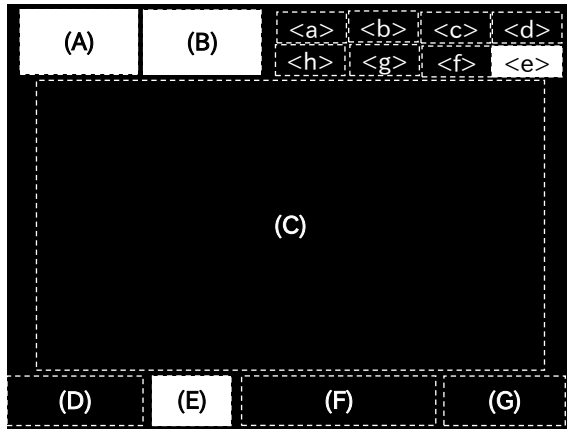

(A) Main operation status

Display	Description
RUN FW	While in forward operation.
RUN RV	While in reverse operation.
RUN 0Hz	While output operation is 0Hz. Also displayed by input terminal 030[DB], 065[SON], 066[FOC]. There are parameters that can not be changed during operation.
TRIP	Displays the trip status. The resettable error is released by the reset operation.
WARN	When a conflict in the setting happens. For details, refer P1 User's Guide.
STOP (red)	This is the stop display when the RUN command has been input but a forced stop has been performed by some function. <ul style="list-style-type: none"> <li>· The RUN command was input when the frequency reference value is 0 Hz.</li> <li>· The inverter stopped by the Keypad STOP key when the RUN command is other than the Keypad.</li> <li>· The inverter stopped by the shutoff terminal function [RS], [FRS], etc, when the RUN command is other than the Keypad.</li> <li>· The inverter stopped by the Instantaneous power failure non-stop function.</li> </ul> At this time, the RUN lamp blinks.
STOP (white)	This is the stop display when there is no run command. <ul style="list-style-type: none"> <li>· If the run command is the keypad RUN key, the inverter immediately enters this stop when the shutoff terminal functions are turned on.</li> </ul>

(Tips)

- If STOP(red),
  - ⇒ Displayed in (F): if the reference frequency is 0.00Hz, make sure that the frequency reference has been inputted.
  - ⇒ For example; if it is being driven by the input terminal 001[FW] and then stopped with the stop key, inverter will not start again the operation unless the input terminal 001[FW] turns off and on again.
  - ⇒ It does not operate when the input terminal 028[RS] or 032[FRS] or Functional safety STO terminal which is the Shutdown function is ON.

(B) Warning status

No.	Display	Description
1	LIM	While: <ul style="list-style-type: none"> <li>· Overload restriction.</li> <li>· Torque limiting.</li> <li>· Overcurrent suppression.</li> <li>· Overvoltage suppression.</li> <li>· Upper or lower frequency limited.</li> <li>· Jump frequency limited.</li> <li>· minimum frequency limited.</li> </ul> Details can be confirmed in [dC-37].
2	ALT	This is displayed with the following functions: <ul style="list-style-type: none"> <li>· Overload warning.</li> <li>· Motor thermal warning.</li> <li>· Inverter thermal warning.</li> <li>· Motor heat warning.</li> </ul> Details can be confirmed in [dC-38].
3	RETRY	While waiting for retry or restart functions. Details can be confirmed in [dC-39].
4	NRDY	While inverter is in a state unfit to operate, even if a RUN command is issued. <ul style="list-style-type: none"> <li>· Main power undervoltage.</li> <li>· Operating only with 24V supply.</li> <li>· Resetting.</li> <li>· Run command is not possible when the input terminal 101[REN](RUN enable) is assigned and it is OFF.</li> </ul> Details can be confirmed in [dC-40].
5	FAN	Cooling-fan life warning is issued. Also, the output terminal 030 [WAF] turned ON.
6	C	Capacitor life warning is issued. Also, the output terminal 029[WAC] turned ON.
7	F/C	When both Capacitor and Cooling-fan life warnings are issued.
8	(None)	Different statuses from those shown above.

(Tips)

- LIM and ALT are indicated when current and internal voltage has risen. Review things such as the load if this error happens too often.
- Above icons are indicated when the cooling-fan and the electrolytic capacitors on the board lifespan has reached to the end.
- When [multi monitor],[While screen] or [Huge monitor], press the Up key (▲) to see the details of the warning.

(E) Keypad's RUN key function

No.	Display	Description
1	oFW	Forward operation from panel's RUN key.
2	oRV	Reverse operation from panel's RUN key.
3	>FW	By 023 [F-OP] Force operation or the keypad VOP or etc. functions, Keypad RUN key is forcibly enabled (>FW=Forward, >RV=Reverse)
4	>RV	
5	(None)	Different operation (other than RUN).

(Tips)

- When the RUN key on the keypad is enabled, oFW etc. are displayed on (E).
- Operating from the operation panel, first review the [AA111] RUN command input source selection. Or Check [dC-10] (RUN command input source monitor).

• Each part on the screen of keypad (continue).

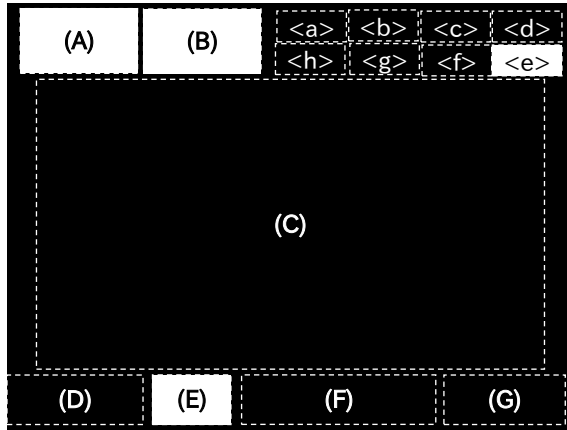

**<a> Power supply status**

Number	Display	Description
1	(None)	Main and control power is supplied.
2	CTRL	Control power supply is connected.
3	24V	Only P+/P- 24V supply is connected.

(Tips)

- Indicates the power supply input status.  
When CTRL or 24V is displayed, the inverter cannot be run because the main power supply is not input.  
Check the main power supply.

**<b> SET function status**

Number	Display	Description
1	M1	When input terminal 024[SET] is not assigned or is assigned but in OFF state (1st-motor is enabled).
2	M2	Input terminal 024[SET] is assigned and in ON state (2nd-motor is enabled).

- When the input terminal 024[SET] is not being used, M1 is displayed.  
If the centre character of the parameter is “-”(such as [AC-01]) or “1”( such as [AA111]) that parameter is valid, if it is “2” (such as [AA211]), it will be ignored.  
If the 2nd setting is valid, Output terminal 012[SETM] 2nd control selected becomes ON.

**<c> Parameter display**

Number	Display	Description
1	(None)	Display all modes.
2	UTL	Individual function display mode.
3	USR	User’s settings display mode.
4	CMP	Data comparator display mode.
5	MON	Only monitor display mode.

(Tips)

- Is displayed if it operating under a display limiting function. Change the setting of [UA-10] in the case that the parameters are not being displayed.

**<d> Monitor screen number**

(Tips)

- Each screen displayed has a number. When contacting to us, make reference to the screens with its number.

**<e> Functional safety**

(Tips)

- If there is any indication, the inverter is in the cut-off state.  
※Refer "■Functional safety STO terminals" of Chapter 2.11 "Control circuit wiring section"

**<f> Control mode**

Number	Display	Description
1	(None)	Speed control mode.
2	TRQ	Torque control mode.
3	POS	Position control mode.

(Tips)

- This display shows the control mode.

**<g> EzSQ mode**

Number	Display	Description
1	(None)	EzSQ not selected.
2	Ez_S	EzSQ programme not running.
3	Ez_R	EzSQ programme running.

(Tips)

- This display shows the operation status of the EzSQ function.

**<h> Display of special function status**

No.	Indication	Description
h1	(None)	The inverter is not in the special status.
h2	AUT	The inverter is auto-tuning.
h3	SIM	The inverter is in the simulation mode.

(Tips)

- If the function is displayed, it means that the inverter is in the special state.  
For more information, refer to the user’s guide.



### 5.3 Possible errors and solutions

✧ If the corrective action does not solve the problem, refer to the user's guide where there are more detailed descriptions. Or please consult inquiry desk described "Contact information" on the page S-3.

Event ▶	Estimated cause ▶	Corrective action
Screen is not displayed even when POWER LED is illuminated.	• Keypad in idle mode.	• Press a key of the Keypad and the screen will be displayed.
	• Keypad has been detached.	• Recover and reinsert the keypad.
After issuing a RUN command, the motor does not start.	• Trip has occurred.	• If an error causes a trip, the cause of the trip will have to be removed before resetting.
	• A warning came up.	• If a warning has occurred, resolve the data inconsistency.
	• Command function not introduced.	• Check that the RUN command [AA111] and the reference (terminal, keypad, etc.) are correct.
	• Speed source not introduced.	• Check that the main speed source [AA101] and the reference (terminal, panel, etc.) are correct.
	• Activate a stop function.	• Check if functional safety terminals and O28[RS]/O32[FRS] terminals are enabled through the terminal status [dA-51] .
	• Motor is restricted/locked.	• Check if there is a braking operation or something inhibiting the motor (Like something clogged) .
	• Wiring is disconnected.	• Check that there are not disconnected cables in the output to the motor and in the internal side.
Cannot change settings.	• Inverter is in running.	• There are parameters that cannot be modified while running, refer to the parameter list.
Motor rotates in reverse.	• Wrong wiring order of the motor phases.	• Rotation is reversed by replacing two phases of the motor.
Motor/machinery sound is loud.	• Carrier frequency setting is low.	• Set higher carrier frequency [bb101], however, that may increase the heat generation, the generated noise or leakage current. As a result, some models may require output current derating.

Event ▶	Estimated cause ▶	Corrective action
<p>Motor speed does not increase.</p>	<ul style="list-style-type: none"> <li>Overload restriction function is in operation.</li> </ul>	<ul style="list-style-type: none"> <li>The overload restriction [bA122] lowers the output frequency as the output current increases. It is necessary to suppress overcurrent by such as increasing the acceleration time [AC120].</li> </ul>
	<ul style="list-style-type: none"> <li>Frequency reference is being limited.</li> </ul>	<ul style="list-style-type: none"> <li>If the Upper frequency limit [bA102] setting is low, increase the setting. Frequency limiting uses the Upper frequency limit instead of the maximum frequency setting.</li> </ul>
	<ul style="list-style-type: none"> <li>Frequency reference value is low.</li> </ul>	<ul style="list-style-type: none"> <li>Increase the frequency reference or cancel any other high priority frequency reference such as jogging or multi-speed.</li> </ul>
	<ul style="list-style-type: none"> <li>Acceleration time is long.</li> </ul>	<ul style="list-style-type: none"> <li>If the acceleration time [AC120] setting is long, it accelerates slowly. Reduce the acceleration time gradually.</li> </ul>
<p>Output frequency is unstable.</p>	<ul style="list-style-type: none"> <li>Several parameters are not adequately set.</li> </ul>	<ul style="list-style-type: none"> <li>Check for the motor basic parameters.</li> </ul>
	<ul style="list-style-type: none"> <li>Big variation in the load.</li> </ul>	<ul style="list-style-type: none"> <li>Review the power capacity of both the inverter and motor.</li> </ul>
	<ul style="list-style-type: none"> <li>Supply voltage fluctuates.</li> </ul>	<ul style="list-style-type: none"> <li>To keep to a minimum the supply fluctuations, by using an optional AC reactor(ALI-****), DC link choke(DCL-****) or/and input filter, improvement is possible.</li> </ul>
<p>Low torque or Torque stall.</p>	<ul style="list-style-type: none"> <li>V/f control is selected.</li> </ul>	<ul style="list-style-type: none"> <li>Can switch in [AA121] to torque boost, sensorless vector control, ... etc.</li> </ul>
	<ul style="list-style-type: none"> <li>It is being used for lift down application.</li> </ul>	<ul style="list-style-type: none"> <li>If the torque in the regenerative operation is not enough, Use a braking resistor or regenerative braking unit.</li> </ul>
	<ul style="list-style-type: none"> <li>Very heavy load.</li> </ul>	<ul style="list-style-type: none"> <li>Review the capacity of both the inverter and motor.</li> </ul>
<p>In operation the circuit breaker gets activated.</p>	<ul style="list-style-type: none"> <li>Large leakage current.</li> </ul>	<ul style="list-style-type: none"> <li>Lower the carrier frequency [bb101] .</li> <li>Increase the sensitivity current of the earth leakage breaker or replace it with a high sensitivity current.</li> <li>Enabling the built-in EMC filter will increase the leakage current. If necessary, select an appropriate earth leakage circuit breaker or consider turning off the EMC filter.</li> </ul>
<p>Noise interferes with the TVs and radios nearby the inverter.</p>	<ul style="list-style-type: none"> <li>Irradiated noise from the inverter.</li> </ul>	<ul style="list-style-type: none"> <li>If possible, separate the wiring from the TV and radio.</li> <li>Put a zero-phase reactor either in the main supply input or in the output of the inverter.</li> </ul>

## Chapter 6

### Inspection and Maintenance

#### Read this before performing any inspection or maintenance!

##### There is risk of electric shock!

- Before an inspection the supply power must be cut off, and then wait at least 10 minutes(\*1) or 15 minutes(\*2) before proceeding.

(Make sure that the charge lamp in the inverter is off. Furthermore, measure the voltage between the P and N terminals and make sure that the voltage is less than 45V)

- \*1) For models P1-00044-L to P1-01240-L (P1-004L to P1-220L) and P1-00041-H to 00620-H (P1-007H to P1-220H)
- \*2) For models P1-01530-L to P1-02950-L (P1-300L to P1-550L) and P1-00770-H to P1-06600-H (P1-300H to P1-3150H)

- Other than the designated person, do not perform any maintenance, inspection or component replacement. (Before starting to operate, remove any wristwatch or metal accessories such as bracelets, and use always isolated tools)

## 6.1 Inspection and maintenance notes

### 6.1.1 Daily inspection

Check and confirm for the following abnormalities while the inverter is operating:

No.	Details	✓
1	Motor operates as per settings	<input type="checkbox"/>
2	No abnormalities in the environment	<input type="checkbox"/>
3	Cooling-system running normally	<input type="checkbox"/>
4	No abnormal vibration nor noise	<input type="checkbox"/>
5	No abnormal overheating nor discoloration	<input type="checkbox"/>
6	No unusual odour	<input type="checkbox"/>

While operating, check the inverter input voltage using a multimeter or a similar tool to confirm:

No.	Details	✓
1	No voltage supply fluctuation	<input type="checkbox"/>
2	Line-to-line voltage balance	<input type="checkbox"/>

### 6.1.2 Regarding the functional safety

The contents related to the functional safety, refer to the separate "SJ-P1 Functional Safety Guide" (NT 2512\*X)

### 6.1.3 Cleaning

Keep the inverter in a clean condition.

No.	Details	✓
1	When cleaning the inverter, use a soft cloth soaked in neutral detergent to gently wipe up the dirtied parts.	<input type="checkbox"/>
2	Do not use solvents like acetone, benzene, toluene or alcohol to clean the inverter, as it can melt its surface or peel off the coating.	<input type="checkbox"/>
3	For the display of the panel do not use detergent or alcohol to clean it.	<input type="checkbox"/>

### 6.1.4 Periodic inspection

Check the parts that are only accessible while the inverter is stopped. The periodic inspection is a vital point that has to be carried out, for any periodic inspection, please contact your Hitachi inverter distributor.

No.	Details	✓
1	Check for abnormalities in cooling system · Heat sink cleaning, etc.	<input type="checkbox"/>
2	Check the fastening and tighten · By the effects of oscillations, thermal expansion, etc..., the screws and bolts may become loose, proceed to tighten after confirming.	<input type="checkbox"/>
3	Check that there is no damage or corrosion to the conductors and insulators	<input type="checkbox"/>
4	Measurement of the dielectric breakdown voltage of insulators	<input type="checkbox"/>
5	Check and replacement of cooling-fan, smoothing capacitor and relay in main circuit.	<input type="checkbox"/>

## 6.2 Daily and periodic inspections

Inspected part	Inspection entry	Details of inspection	Inspection cycle			Inspection method	Criterion	Tester device
			Daily	Every				
				1 year	2 years			
General	Surrounding environment	Check the ambient temperature, level of humidity, dust, ... etc..	○			Refer to Chapter 2 "Installation and Wiring".	Ambient temperature, level of humidity are within the range. No frozen part. No condensation.	Thermometer. Hygrometer. Data logger.
	Whole inverter	Check that there are no abnormal vibrations or noises.	○			Check visually and auditorily.	No abnormality.	
	Power supply voltage	Check that the main circuit voltage is normal.	○			Measure the line-to-line voltage of the inverter main circuit terminals R,S and T.	Within the AC voltage permissible variation.	Multimeter. Digital multimeter.
Main circuit	General check	(1)Check the resistance between the main circuit and the ground terminals.		○		Remove the inverter main circuit terminals input/output wiring and the control terminal board, and remove the jumper for the internal filter, after that, shortcircuit the terminals R,S,T,U,V,W,P,PD,N,RB,RO,TO, and measure between this shortcircuit and the ground.	Resistance no less than 5MΩ.	DC 500V class Ohmmeter. (megger®)
		(2)Check looseness in fastened parts.		○		Confirm tighten of fasteners.	No abnormality.	
		(3)Check for overheating traces.		○		Check visually.	No abnormality.	
	Conductor and cables	(1)Check for straining in conductors. (2)Check for cable coating damage.		○		Check visually.	No abnormality.	
	Terminal block	Check for any damage.		○		Check visually.	No abnormality.	
	Inverter and converter circuits (Including resistors)	Check the resistance between all the terminals.			○	Remove the inverter main circuit terminal wiring, and measure the following: - Resistance between terminals RST and PN. - Resistance between terminals UVW and PN	Refer the "6.5 Checking method for inverter/converter". The inverter, capacitor and thyristor lifespan before replacing the components is of 10 <sup>6</sup> start/stop cycles. *3)	Analog multimeter.
	Smoothing capacitor	(1)Check for capacitor fluid leakage (2)Check that the relief valve does not swells or protudes.	○		○	Check visually.	No abnormality. Estimated years life span before exchanging component: 10 years. *1) *3) *4)	Capacitance meter.
Relay	(1)No chatter sound while operating. (2)Check contacts for damage.		○	○	Check auditorily. Check visually.	No abnormality. No abnormality.		
Control and protection circuits	Operation check	(1) While performing a unit operation of the inverter, check the balance of the output voltage among the individual phases.		○		Measure the voltage between the U,V,W terminals of the inverter main circuit.	Phase-to-phase voltage balance 200V class: within 4V. 400V class: within 8V.	Digital multimeter. Voltmeter. Ammeter.
		(2)Carry out a sequential protection test, and check the protective and display circuits for any abnormality.		○		Simulate a shortcircuit or open of the inverter output protection circuit.	An error must be detected according to the sequence.	
Cooling system	Cooling-fan	(1) Check that there are no abnormal vibrations or noises.	○			Turn by hand while electricity is not being supplied.	Smooth operation. No abnormality. Replace every: 10 years. *2) *3) *5)	
		(2)Check for loose joints.		○		Check visually.		
	Heat sink	Check for obstructions/clogging.		○		Check visually.	Check that there is no clogging.	
Display	Display	(1) Check if the charge lamp LED and the Keypad's LEDs and LCD light up.	○			Check visually.	Confirm they light up.	
		(2)Display cleaning.		○		With cleaning rag.		
	Meter	Check that Indicated values are normal.	○			Check the meters readings on the control panel.	Regulation and control value are satisfactory.	Voltmeter. Ammeter. Etc.
Motor	General	(1)Check that there are no abnormal vibrations or noises.	○			Check visually, auditorily, and by touch.	No abnormality.	
		(2)Check that there is no odour.	○			Check for abnormal superheating, damages an so on.	No abnormality.	
	Insulation resistance	Check the resistance between the main circuit and the ground terminals.			*6)	Detach the U,V,W terminals from the inverter main circuit, and shortcircuit the motor wiring, mesure with the Megger® between the motor wiring and ground terminal.	No less than 5MΩ.	DC 500V class Ohmmeter. (megger®)

\*1) The life span of the smoothing capacitor is influenced by the ambient temperature. Refer to [Smoothing capacitor life span curve] for replacing measures.

\*2) The life span of the cooling-fan is influenced by the ambient temperature, the dirt and the change in its environmental conditions. Check these circumstances on the usual inspection.

\*3) The estimated time before replacement (Number of years/cycle) and the [Smoothing capacitor life span curve] are based on the design lifespan, not guaranteed.

\*4) In the case that the capacitors are replaced after that the storage period of 3 years has expired, perform aging under the following conditions before using the inverter:

- First, apply for 1 hour the 80% of the capacitor rated voltage at ambient temperature.
- Then, raise the voltage to 90%, and keep it for 1 more hour.
- Finally, apply for 5 hours the rated voltage at ambient temperature.

\*5) If the cooling fan is locked due to dust, etc., it takes 5 to 10 seconds to restart even if dust is removed.

\*6) Follow the instruction manual for the motor.

### 6.3 Insulation resistance test

- When testing an external circuit with a megger, disconnect all the external circuit cables from the inverter to prevent it from being exposed to the test voltage.
- In the control circuit carry out a conduction test, use a multimeter (with high resistance range), do not use a megger® or buzzer /continuity tester.
- The insulation resistance test of the inverter itself is carried out only at the main circuit, do not perform an insulation resistance test in the control circuit.
- It is recommended the use of a DC500V megger® for the insulation resistance test.
- Before the main circuit test with a megger, remove the jumper for switching the inverter's internal filter function, and then connect terminals R, S, T, U, V, W, P, PD, N, RB, RO, and TO by wires as shown in the figure below. Subsequently, carry out the test.
- After the test using the megger, remove the wires from terminals R, S, T, U, V, W, P, PD, N, RB, RO, and TO, and connect the jumper for switching the inverter's internal filter function at the original position.
- Furthermore, depending on the model, the RB terminal may not be present. Please confirm in "2.9 Wiring to the main circuit terminal block".

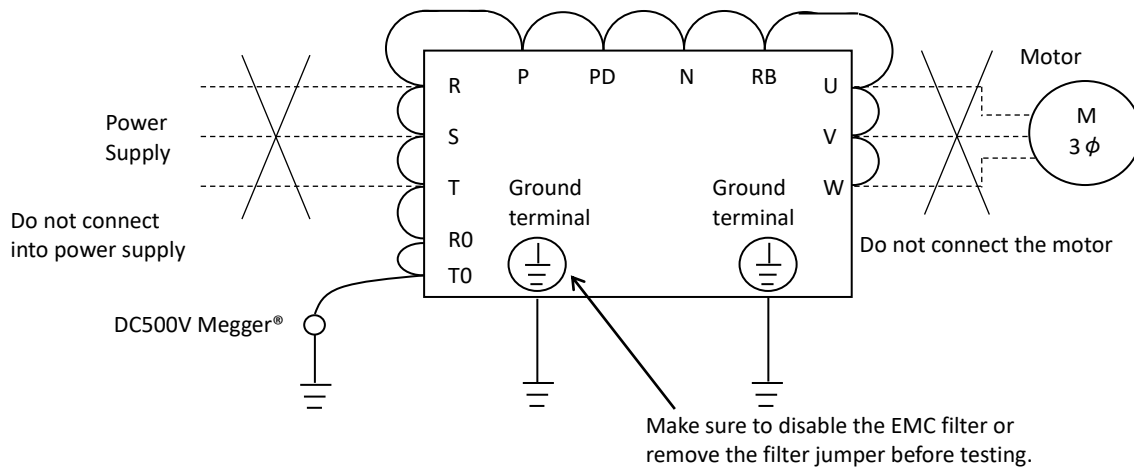

### 6.4 Dielectric withstand test

- Do not carry out a withstand voltage test for the inverter. The test may damage its internal parts, deteriorating the inverter.

### 6.5 Checking method for inverter/converter

• Using the analog multimeter, you can check if the inverter or converter unit are defective or non-defective.

(Preparation)

- ① Remove the supply (R,S,T) and motor wiring (U,V,W), and also the regenerative braking resistor(P,RB).
- ② Prepare the multimeter. (Application measurement range is 1Ω)

(Checking method)

• Measure and check the current conduction at each of the inverter main circuit terminals R, S, T, U, V, W, RB, P, N, by changing the polarity of the multimeter alternately.

	Multimeter polarity		Measured result	
	⊕ (Red)	⊖ (Black)		
Converter circuit	D1	R	PD	No conduction
		PD	R	Conduction
	D2	S	PD	No conduction
		PD	S	Conduction
	D3	T	PD	No conduction
		PD	T	Conduction
Inverter circuit	D4	R	N	Conduction
		N	R	No conduction
	D5	S	N	Conduction
		N	S	No conduction
	D6	T	N	Conduction
		N	T	No conduction
BRD part	TR1	U	P	No conduction
		P	U	Conduction
	TR2	V	P	No conduction
		P	V	Conduction
	TR3	W	P	No conduction
		P	W	Conduction
TR4	U	N	Conduction	
	N	U	No conduction	
TR5	V	N	Conduction	
	N	V	No conduction	
TR6	W	N	Conduction	
	N	W	No conduction	
TR7	RB	P	No conduction	
	P	RB	Conduction	
	RB	N	Don't care	
	N	RB	No conduction	

\*1) Before checking the circuits, measure the voltage across terminals P and N with the multimeter in DC bus voltage range mode to confirm that the smoothing capacitor has been fully discharged.

\*2) When not conducting, it shows an infinite value. Due to the influence of the smoothing capacitor, it may show momentarily any other value other than infinite. When the measured terminal is conductive, the tester reading is several ohms to several tens of ohms. The measurements with different multimeters may not match exactly, but as long the values are close between them, it is acceptable.

\*3) The chopper braking circuit is built-in in the models below:  
 P1-00044-L to P1-01240-L(004L to 220L ND rated)  
 P1-00041-H to P1-00930-H(007H to 370H ND rated)

**Model(P1-\*\*\*\*\*)**  
 200V class : 00044-L(004L) to 00600-L(110L)  
 400V class : 00041-H(007H) to 00310-H(110H)

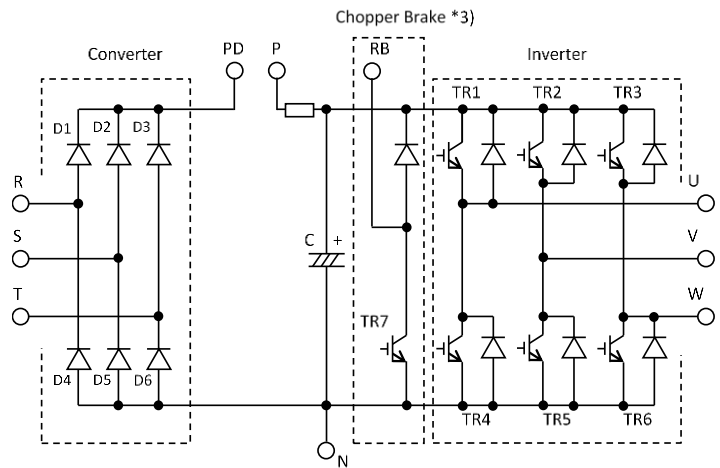

**Model(P1-\*\*\*\*\*)**  
 200V class : 00800-L(150L) to 02950-L(550L)  
 400V class : 00400-H(150H) to 06600-H(3150H)

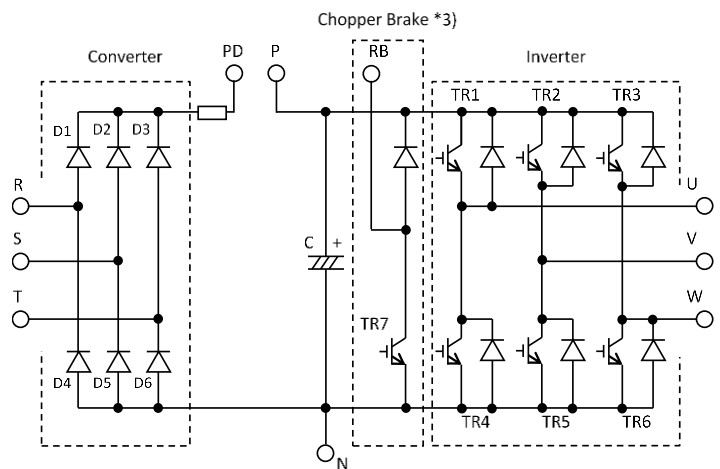

## 6.6 Smoothing capacitor life span curve

※80% of the ND rated current value for continuous drive.

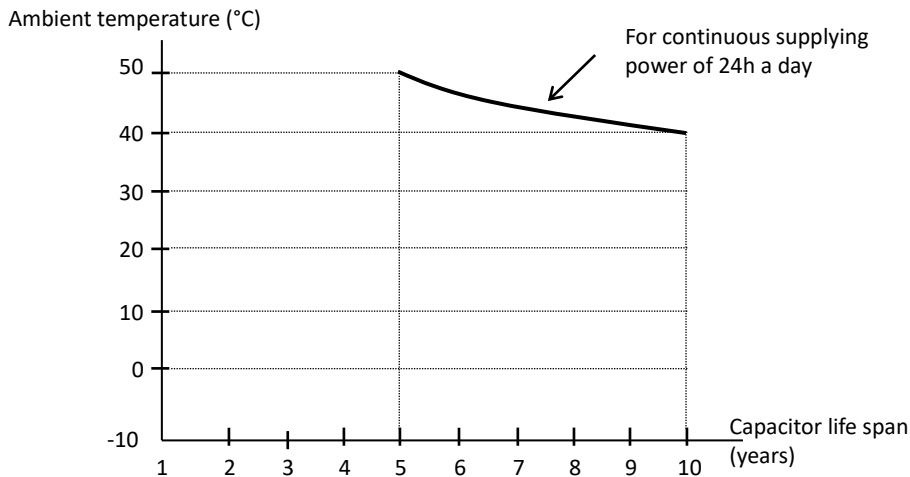

\*1) The ambient temperature is considered to be measured around 5 cm of the bottom centre of the inverter (Atmosphere temperature). If the inverter is in an enclosure, it will be the temperature inside the case.

\*2) The smoothing capacitor has a limited life because of the chemical reactions occurring inside the capacitor while operating. The capacitor should be replaced after 10 years of use, as a reference standard (10 years is not the guaranteed lifespan, but rather, the design lifespan). Note that the smoothing capacitor lifespan will be shortened if the inverter is used at a high ambient temperature or with a heavy load that requires a current beyond the rated current.

## 6.7 Lifespan alarm output

- By the self-diagnostic, it is possible to output an alarm in regards of the inverter own internal components lifespan when the lifespan is nearing to its end (Including the circuit board electrolytic capacitor and cooling-fan, and excluding the main circuit smoothing capacitor). Use this to get a reference for when the components should be replaced. Particularly, consult the lifespan diagnosis monitor [dC-16] and the output terminal function selection [CC-01]~[CC-07]. It should be noted that the warning itself is based on the design lifespan, and thus, is not a guaranteed measurement. Depending on the environment, the operation conditions, etc. problems may arise, to avoid that, is recommended an early maintenance.

6.8 Input/output voltage, current and power measurement methods

Standard equipment for measuring input/output voltage, current, and power measurement.

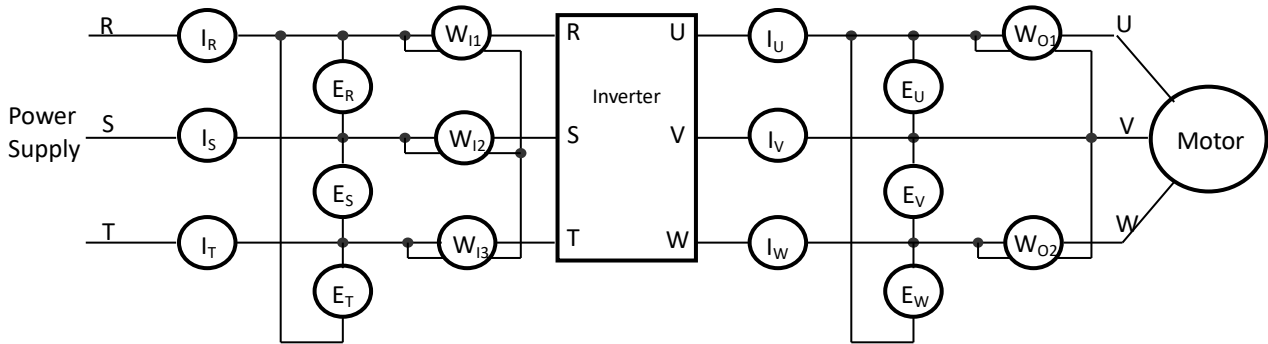

Measured data	Measuring point	Measuring instrument	Remarks	Standard reference values
Input voltage $E_{IN}$	R-S, S-T, T-R ( $E_R$ ), ( $E_S$ ), ( $E_T$ )	Moving-iron voltmeter or Rectifier-type voltmeter	Effective value of full waves	200V class:200 to 240V 50/60Hz 400V class:380 to 500V 50/60Hz
Input current $I_{IN}$	R, S, T current ( $I_R$ ), ( $I_S$ ), ( $I_T$ )	Moving-iron ammeter	Effective value of full waves	If there is unbalance in the input supply $I_{IN}=(I_R+I_S+I_T)/3$
Input power $W_{IN}$	R-S, S-T, T-R ( $W_{11}$ )+( $W_{12}$ )+( $W_{13}$ )	Electrodynamometer-type wattmeter	Effective value of full waves	Three-wattmeter method
Input power factor $Pf_{IN}$	Is calculated from the measured values of the input voltage ( $E_{IN}$ ), input current ( $I_{IN}$ ) and supply power ( $W_{IN}$ ) $Pf_{IN} = \frac{W_{IN}}{\sqrt{3} \times E_{IN} \times I_{IN}} \times 100$			
Output voltage $E_{OUT}$	U-V, V-W, W-U ( $E_U$ ), ( $E_V$ ), ( $E_W$ )	Moving-iron voltmeter or Rectifier-type voltmeter	Effective value of fundamental wave	
Output current $I_{OUT}$	U, V, W current ( $I_U$ ), ( $I_V$ ), ( $I_W$ )	Moving-iron ammeter	Effective value of full waves	
Output power $W_{OUT}$	U-V, V-W ( $W_{01}$ )+( $W_{02}$ )	Electrodynamometer-type wattmeter	Effective value of full waves	Two-wattmeter method (Otherwise the three-wattmeter method)
Output power factor $Pf_{OUT}$	Is calculated from the measured values of the output voltage ( $E_{OUT}$ ), output current ( $I_{OUT}$ ) and output power ( $W_{OUT}$ ). $Pf_{OUT} = \frac{W_{OUT}}{\sqrt{3} \times E_{OUT} \times I_{OUT}} \times 100$			

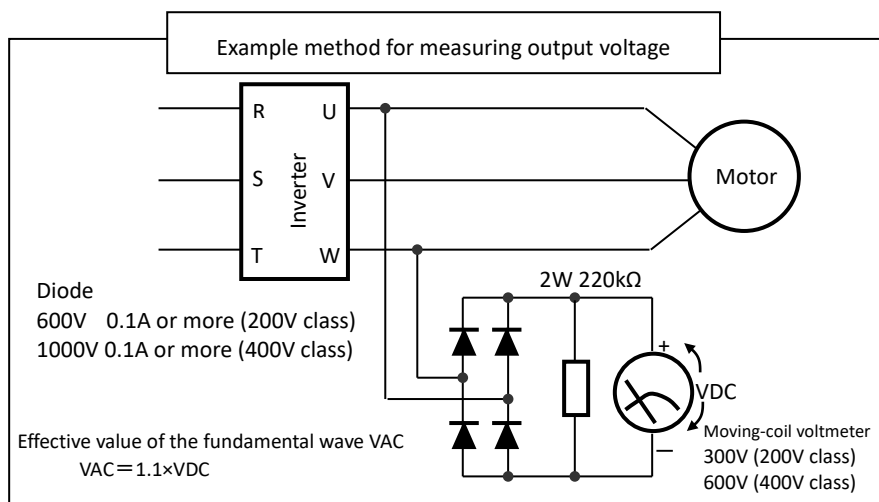

When measuring...

1. To measure the output voltage, use an instrument that reads the effective value of the fundamental wave. To measure the current or the power, use an instrument that reads the effective value of full waves.
2. Since the inverter output waveform is controlled by PWM, it has a large margin of error, especially at low frequencies. In many cases, general multimeters may be defective for the measurement, because of the adverse effects of the noise.



## Chapter 7 Specifications

## 7.1 200V class specifications

Model name P1-****-L		00044	00080	00104	00156	00228	00330	00460	00600	00800	00930	01240	01530	01850	02290	02950		
ND standard capacity P1-****L		004	007	015	022	037	055	075	110	150	185	220	300	370	450	550		
Applicable motor capacity (4 poles)(kW)	VLD	0.75	1.5	2.2	3.7	5.5	7.5	11	15	18.5	22	30	37	45	55	75		
	LD	0.75	1.5	2.2	3.7	5.5	7.5	11	15	18.5	22	30	37	45	55	75		
	ND	0.4	0.75	1.5	2.2	3.7	5.5	7.5	11	15	18.5	22	30	37	45	55		
Output	Rated output current(A) *1)	VLD	4.4	8.0	10.4	15.6	22.8	33.0	46.0	60.0	80.0	93.0	124	153	185	229	295	
		LD	3.7	6.3	9.4	12.0	19.6	30.0	40.0	56.0	73.0	85.0	113	140	169	210	270	
		ND	3.2	5.0	8.0	11.0	17.5	25.0	32.0	46.0	64.0	76.0	95.0	122	146	182	220	
	Overload current rating	VLD	110% 60sec / 120% 3sec															
		LD	120% 60sec / 150% 3sec															
		ND	150% 60sec / 200% 3sec															
	Rated output voltage		Three-phase(3 wire)200 to 240V (Corresponding to the incoming voltage)															
	Rated capacity (kVA)	200V	VLD	1.5	2.8	3.6	5.4	7.9	11.4	15.9	20.8	27.7	32.2	43.0	53.0	64.1	79.3	102.2
			LD	1.3	2.2	3.3	4.2	6.8	10.4	13.9	19.4	25.3	29.4	39.1	48.5	58.5	72.7	93.5
			ND	1.1	1.7	2.8	3.8	6.1	8.7	11.1	15.9	22.2	26.3	32.9	42.3	50.6	63.0	76.2
240V		VLD	1.8	3.3	4.3	6.5	9.5	13.7	19.1	24.9	33.3	38.7	51.5	63.6	76.9	95.2	122.6	
		LD	1.5	2.6	3.9	5.0	8.1	12.5	16.6	23.3	30.3	35.3	47.0	58.2	70.3	87.3	112.2	
		ND	1.3	2.1	3.3	4.6	7.3	10.4	13.3	19.1	26.6	31.6	39.5	50.7	60.7	75.7	91.5	
Input	Rated input current(A) *2)	VLD	5.2	9.5	12.4	18.6	27.1	39.3	54.8	71.4	95.2	110.7	147.6	182.1	220.2	272.6	351.2	
		LD	4.4	7.5	11.2	14.3	23.3	35.7	47.6	66.7	86.9	101.2	134.5	166.7	201.2	250.0	321.4	
		ND	3.8	6.0	9.5	13.1	20.8	29.8	38.1	54.8	76.2	90.5	113.1	145.2	173.8	216.7	261.9	
	Rated input AC voltage *3)		Control power supply : Single-phase supply 200 to 240V (Permissible AC voltage 170 to 264) , 50Hz(allowable variation range: 47.5 to 52.5Hz)/60Hz (allowable variation range:57 to 63Hz) Main circuit power supply: Three-phase(3 wire) 200 to 240V (Permissible AC voltage 170 to 264) , 50Hz(allowable variation range: 47.5 to 52.5Hz)/60Hz (allowable variation range:57 to 63Hz)															
Power supply capacity (kVA) *4)	VLD	2.0	3.6	4.7	7.1	10.3	15.0	20.9	27.2	36.3	42.2	56.3	69.4	83.9	103.9	133.8		
	LD	1.7	2.9	4.3	5.4	8.9	13.6	18.1	25.4	33.1	38.6	51.3	63.5	76.7	95.3	122.5		
	ND	1.5	2.3	3.6	5.0	7.9	11.3	14.5	20.9	29.0	34.5	43.1	55.3	66.2	82.6	99.8		
Carrier frequency variation *5)	VLD	0.5 to 10.0kHz																
	LD	0.5 to 12.0kHz																
	ND	0.5 to 16.0kHz																
Motor start torque *6)		200%/0.3Hz																
Braking	Regenerative	Internal BRD circuit (external discharge resistor value)											External regenerative braking unit					
	Minimum resistance value(Ω)	50	50	35	35	35	16	10	10	7.5	7.5	5	-	-	-	-		
Dimensions *7)	H(height)(mm)	255	255	255	255	255	260	260	260	390	390	390	540	550	550	700		
	W(width)(mm)	150	150	150	150	150	210	210	210	245	245	245	300	390	390	480		
	D(Depth)(mm)	140	140	140	140	140	170	170	170	190	190	190	195	250	250	250		
Protective structure		IP20 – UL Open Type																
Aprox. weight (kg)		3	3	3	3	3	6	6	6	10	10	10	22	33	33	47		

\*1) Some models require current derating depending on the carrier frequency setting and ambient temperature. For details, please refer to "20.4 Current Delating Table" of P1 user 's guide.

\*2) The rated input current is the value when the drive is operated in the rated output current. The value of the impedance at the supply side changes due to the wiring, breaker, input reactor, etc. In addition, the input current on the specification nameplate is a UL-certified current.

\*3) Following are for Low Voltage Directive (LVD) compliant.

- Pollution degree 2
- Overvoltage category 3

\*4) The power supply capacity is the value of the rated output current at 220V. The value of the impedance at the supply side changes due to the wiring, breaker, input reactor, etc.

\*5) The setting range of carrier frequency [bb101] / [bb201] is limited according to the [Ub-03] setting(load type selection).

It is recommended to set the carrier frequency settings [bb101]/[bb201] equal or greater than the (maximum output frequency x 10)Hz.

For induction motor IM, it is recommended to set the carrier frequency to 2 kHz or more except V/f control. For synchronous motor (SM)/Permanent magnet motor (PMM), it is recommended to set the carrier frequency to 8 kHz or more.

\*6) The value is specified for the Hitachi standard motor controlled by the sensorless vector control when ND rating.

Torque characteristics may vary by the control system and the use of the motor.

\*7) The key height of keypad are excluded from dimensions. When an option is connected, the depth is increased. Refer to the each optional instruction.

7.2 400V class specifications

Model name P1-****-H		00041	00054	00083	00126	00175	00250	00310	00400	00470	00620	00770	00930	01160	01470	01760	02130	02520	03160		
ND standard capacity P1-****H		007	015	022	037	055	075	110	150	185	220	300	370	450	550	750	900	1100	1320		
Applicable Motor ca- pacity(kW) (4poles)	VLD	1.5	2.2	3.7	5.5	7.5	11	15	18.5	22	30	37	45	55	75	90	110	132	160		
	LD	1.5	2.2	3.7	5.5	7.5	11	15	18.5	22	30	37	45	55	75	90	110	132	160		
	ND	0.75	1.5	2.2	3.7	5.5	7.5	11	15	18.5	22	30	37	45	55	75	90	110	132		
Output	Rated output current (A) *1)	VLD	4.1	5.4	8.3	12.6	17.5	25.0	31.0	40.0	47.0	62.0	77.0	93.0	116	147	176	213	252	316	
		LD	3.1	4.8	6.7	11.1	16.0	22.0	29.0	37.0	43.0	57.0	70.0	85.0	105	135	160	195	230	290	
		ND	2.5	4.0	5.5	9.2	14.8	19.0	25.0	32.0	39.0	48.0	61.0	75.0	91.0	112	150	180	217	260	
	Overload current rating	VLD	110% 60sec / 120% 3sec																		
		LD	120% 60sec / 150% 3sec																		
		ND	150% 60sec / 200% 3sec																		
	Rated output voltage		Three-phase(3 wire)380 to 500V (Corresponding to the incoming voltage)																		
	Rated capa- city (kVA)	400V	VLD	2.8	3.7	5.8	8.7	12.1	17.3	21.5	27.7	32.6	43.0	53.3	64.4	80.4	101.8	121.9	147.6	174.6	218.9
			LD	2.1	3.3	4.6	7.7	11.1	15.2	20.1	25.6	29.8	39.5	48.5	58.9	72.7	93.5	110.9	135.1	159.3	200.9
			ND	1.7	2.8	3.8	6.4	10.3	13.2	17.3	22.2	27.0	33.3	42.3	52.0	63.0	77.6	103.9	124.7	150.3	180.1
500V		VLD	3.6	4.7	7.2	10.9	15.2	21.7	26.8	34.6	40.7	53.7	66.7	80.5	100.5	127.3	152.4	184.5	218.2	273.7	
		LD	2.7	4.2	5.8	9.6	13.9	19.1	25.1	32.0	37.2	49.4	60.6	73.6	90.9	116.9	138.6	168.9	199.2	251.1	
		ND	2.2	3.5	4.8	8.0	12.8	16.5	21.7	27.7	33.8	41.6	52.8	65.0	78.8	97.0	129.9	155.9	187.9	225.2	
Input	Rated input current (A)*2)	VLD	4.9	6.4	9.9	15.0	20.8	29.8	36.9	47.6	56.0	73.8	91.7	110.7	138.1	175.0	209.5	253.6	300.0	376.2	
		LD	3.7	5.7	8.0	13.2	19.0	26.2	34.5	44.0	51.2	67.9	83.3	101.2	125.0	160.7	190.5	232.1	273.8	345.2	
		ND	3.0	4.8	6.5	11.0	17.6	22.6	29.8	38.1	46.4	57.1	72.6	89.3	108.3	133.3	178.6	214.3	258.3	309.5	
	Rated input AC voltage *3)		Control power supply: Single-phase supply 380 to 500V ( Permissible AC voltage 323 to 550V ) , 50Hz(allowable variation range: 47.5 to 52.5Hz)/60Hz (allowable variation range:57 to 63Hz) Main circuit power supply: Three-phase(3 wire) 380 to 500V ( Permissible AC voltage 323 to 550 ) , 50Hz(allowable variation range: 47.5 to 52.5Hz)/60Hz(allowable variation range: 57 to 63Hz)																		
	Power supply capacity (kVA) *4)*9)	VLD	3.7	4.9	7.5	11.4	15.9	22.7	28.1	36.3	42.6	56.3	69.9	84.4	105.2	133.4	159.7	193.2	228.6	286.7	
LD		2.8	4.4	6.1	10.1	14.5	20.0	26.3	33.6	39.0	51.7	63.5	77.1	95.3	122.5	145.2	176.9	208.7	263.1		
ND		2.3	3.6	5.0	8.3	13.4	17.2	22.7	29.0	35.4	43.5	55.3	68.0	82.6	101.6	136.1	163.3	196.9	235.9		
Carrier frequency variation *5)	VLD	0.5 to 10.0kHz															0.5 to 8.0kHz				
	LD	0.5 to 12.0kHz															0.5 to 8.0kHz				
	ND	0.5 to 16.0kHz															0.5 to 10.0kHz				
Starting torque *6)		200%/0.3Hz															180%/0.3Hz				
Braking	Regenerative	Internal BRD circuit (external discharge resistor value)												*8)		Ext. regen. braking unit					
	Minimum resistance value(Ω)	100	100	100	70	70	35	35	24	24	20	15	15	10	10	-					
Dimensions*7)	H(height)(mm)	255	255	255	255	260	260	260	390	390	390	540	550	550	550	700	700	740	740		
	W(width)(mm)	150	150	150	150	210	210	210	245	245	245	300	390	390	390	390	390	480	480		
	D(Depth)(mm)	140	140	140	140	170	170	170	190	190	190	195	250	250	250	270	270	270	270		
Protective structure		IP20 – UL Open Type																			
Aprox.weight (kg)		3	3	3	3	6	6	6	8.5	8.5	8.5	22	31	31	31	41	41	53	53		

\*1) Some models require current derating depending on the carrier frequency setting and ambient temperature. For details, please refer to "20.4 Current Delating Table" of P1 user 's guide.

\*2) The rated input current is the value when the drive is operated in the rated output current. The value of the impedance at the supply side changes due to the wiring, breaker, input reactor, etc. In addition, the input current on the specification nameplate is a UL-certified current.

\*3) Make sure the following for Low Voltage Directive (LVD) compliant.  
- Pollution degree 2, - Overvoltage category 3 (for 380 to 460Vac Input supply), - Overvoltage category 2 (for over 460Vac Input supply)

\*4) The power supply capacity is the value of the rated output current at 440V. The value of the impedance at the supply side changes due to the wiring, breaker, input reactor, etc.

\*5) The setting range of carrier frequency [bb101] / [bb201] is limited according to the [Ub-03] setting(load type selection).  
It is recommended to set the carrier frequency settings [bb101]/[bb201] equal or greater than the (maximum output frequency x 10)Hz.  
For induction motor IM, it is recommended to set the carrier frequency to 2 kHz or more except V/f control. For synchronous motor (SM)/Permanent magnet motor (PMM), it is recommended to set the carrier frequency to 8 kHz or more.

\*6)The value is specified for the Hitachi standard motor controlled by the sensorless vector control when ND rating.  
Torque characteristics may vary by the control system and the use of the motor.

\*7) The key height of keypad are excluded from dimensions. When an option is connected, the depth is increased. Refer to the each optional Guide.

\*8) Usually an external regenerative braking unit is required. However, with an optional built –in chopper braking circuit and external discharge resistor can eliminate a external regenerative unit. The built-in chopper braking circuit is offered by order. In order to purchase, contact to the nearest sales office.

## 7.2 400V class specifications (Continuation)

Model name P1-****-H		03720	04320	04860	05200	05500	06600		
ND standard capacity P1-***H		1600	1850	2000	2200	2500	3150		
Applicable Motor capacity(kW) (4poles)	VLD	185	200	220	250	— *9)	— *9)		
	LD	185	200	220	250	280	355		
	ND	160	185	200	220	250	315		
Output	Rated output current (A) *1)	VLD	372	432	486	520	—	—	
		LD	341	395	446	481	550	660	
		ND	310	370	405	450	500	600	
	Overload current rating	VLD	110% 60sec / 120% 3sec				—		
		LD	120% 60sec / 150% 3sec						
		ND	150% 60sec / 200% 3sec						
	Rated output voltage		Three-phase(3 wire)380 to 500V (Corresponding to the incoming voltage)						
	Rated capa- city (kVA)	400V	VLD	257.7	299.2	336.7	360.2	—	—
			LD	236.2	273.6	308.9	333.2	381.0	457.2
			ND	214.7	256.3	280.5	311.7	346.4	415.6
500V		VLD	322.1	374.1	420.8	450.3	—	—	
		LD	295.3	342.0	386.2	416.5	476.3	571.5	
		ND	268.4	320.4	350.7	389.7	433.0	519.6	
Input	Rated output current (A) *2)*8)	VLD	442.9	514.3	578.5	619.0	—	—	
		LD	406.0	470.2	530.9	572.6	654.7	785.7	
		ND	369.0	440.5	482.1	535.7	595.2	714.2	
	Rated input AC voltage *3)		Control power supply: Single-phase supply 380 to 500V ( Permissible AC voltage 323 to 550V) , 50Hz(allowable variation range: 47.5 to 52.5Hz)/60Hz (allowable variation range:57 to 63Hz) , Main circuit power supply: Three-phase(3 wire) 380 to 500V ( Permissible AC voltage 323 to 550) , 50Hz(allowable variation range: 47.5 to 52.5Hz)/60Hz(allowable variation range: 57 to 63Hz)						
	Power supply capacity (kVA) *4)*8)	VLD	337.5	391.9	440.9	471.7	—	—	
		LD	309.3	358.3	404.6	436.4	498.9	598.8	
		ND	281.2	335.6	367.4	408.2	453.6	544.3	
Carrier frequency variation *5)	VLD	0.5 to 8.0kHz				—			
	LD	0.5 to 8.0kHz							
	ND	0.5 to 10.0kHz							
Starting torque *6)		180% / 0.3Hz							
Braking	Regenerative	External regenerative braking unit							
	Minimum resistance value(Ω)	—							
Dimensions *7)	H(height)(mm)	995	995	995	995	995	1200		
	W(width)(mm)	480	680	680	680	680	580		
	D(Depth)(mm)	370	370	370	370	370	450		
Protective structure		IP20 – UL Open Type							
Aprox. weight (kg)		95	125	125	125	125	170		

\*1) Some models require current derating depending on the carrier frequency setting and ambient temperature. For details, please refer to "20.4 Current Delating Table" of P1 user 's guide. (Please contact us for models not described in the Basic / User's Guide.)

\*2) The rated input current is the value when the drive is operated in the rated output current. The value of the impedance at the supply side changes due to the wiring, breaker, input reactor, etc. In addition, the input current on the specification nameplate is a UL-certified current.

\*3) Make sure the following for Low Voltage Directive (LVD) compliant.

- Pollution degree 2, - Overvoltage category 3 (for 380 to 460Vac Input supply), - Overvoltage category 2 (for over 460Vac Input supply)

\*4) The power supply capacity is the value of the rated output current at 440V. The value of the impedance at the supply side changes due to the wiring, breaker, input reactor, etc.

\*5) The setting range of carrier frequency [bb101] / [bb201] is limited according to the [Ub-03] setting(load type selection).

It is recommended to set the carrier frequency settings [bb101]/[bb201] equal or greater than the (maximum output frequency x 10)Hz.

For induction motor IM, it is recommended to set the carrier frequency to 2 kHz or more except V/f control. For synchronous motor (SM)/Permanent magnet motor (PMM), it is recommended to set the carrier frequency to 8 kHz or more.

\*6)The value is specified for the Hitachi standard motor controlled by the sensorless vector control when ND rating.

Torque characteristics may vary by the control system and the use of the motor.

\*7) The key height of keypad are excluded from dimensions. When an option is connected, the depth is increased. Refer to the each optional Guide.

\*8) The rated input current and power supply capacity of P1-03720-H(P1-1600H) and upper models are described under the condition that the power factor improving reactor is installed.

\*9) P1-05500-H (P1-2500H) and P1-06600-H (P1-3250H) support ND (nomal duty)/LD(low duty) double rating.

## 7.3 Common specifications

PWM system		Sine-wave PWM system		
Output frequency range *1)		0.00 to 590.00Hz		
Frequency accuracy		For the highest frequency, digital±0.01%, analog±0.2% (25±10°C)		
Frequency resolution		Digital: 0.01Hz Analog: Ai1 terminal/Ai2 terminal:12bit/0 to +10V or 0 to +20mA, Ai3 terminal 12bit/-10 to +10V		
Control system *2)		IM	V/f control (constant torque/reduced torque/ free / automatic boost control ) V/f with encoder( constant torque/reduced torque/ free / automatic boost control ) Cascade type sensorless vector control, 0Hz sensorless vector control, Vector control with encoder	
		SM/PMM	synchronous startup for smart sensorless vector control , IVMS start type sensorless vector control	
Speed fluctuation *3)		±0.5%(sensorless vector control)		
Acceleration/deceleration time		0.00 to 3600.00s (Linear, S-curve, U-curve, Inverted-U-curve, EL-S-curve)		
Display		Output frequency, Output current, Output torque, trip history, input/output terminal status, input/output terminal function, input/output power *4), PN voltage, etc, the rest is described in the chapter 4.		
Start functions		DC braking after the start, matching frequency after the start, active frequency matching start, Low-voltage start, retry restart.		
Stop functions		After free run stop, deceleration stop, DC braking or external DC braking operation (Braking force, time, adjustment of operation speed)		
Stall prevention function		Overload limit function, overcurrent suppression, overvoltage suppression function		
Protection functions *5)		Overcurrent error, Overload error, Brake resistor overload, Overvoltage error, Memory error, Undervoltage error, Current detector error, CPU error, External trip error, USP error, Ground error, Supply overvoltage error, Power loss error, Temperature detector error, Cooling-fan rotation speed decrease temperature error, Temperature error, Input open-phase error, IGBT error, Output open-phase error, Thermistor error, brake error, low-speed range overload error, Controller overload error, RS485communication error, RTC error, EzSQ related error, option related error, functional safety related error, position control range error, speed deviation error, position deviation error, overspeed error, contactor error, PID start error.		
Other functions		V/f free setting (7 points), upper and lower speed limit, speed jump, curve acceleration and deceleration, manual torque boost, energy-saven operation, analog output adjustment, minimum speed, carrier frequency adjustment, motor electronic thermal function(free is possible), inverter thermal function, external start-end(speed and rate), frequency input selection, trip retry, restart stop, various signal output, initialization setting, PID control, auto-decel at shut-off, brake control function, commercial power switching function, auto-tuning (on/offline), etc. the rest is described in the chapter 4.		
Input	Frequency reference	Keypad	UP, DOWN keys according to the set parameter.	
		External signal *6)	Ai1/Ai2 terminal (for voltage input)	0 to 10 VDC set by the voltage input (Input impedance:10kΩ)
			Ai1/Ai2 terminal (for current input)	0 to 20mA set by the current input (Input impedance:100Ω)
			Ai3 terminal	-10 to +10 VDC set by the voltage input (Input impedance:10kΩ)
			Multi-speed terminal	16multi-speed(With the use of the intelligent input terminal)
	Pulse train-input	Maximum 32 kHz×2		
	Communication port	RS485 serial communication (Protocol: Modbus-RTU)		
	RUN/Stop Forward/Reverse	Keypad	RUN/Stop key (With the set parameter, forward/reverse can be switched)	
		External signal	Forward (FW)/ Reverse(RV)/ 3-wire input (When input terminal functions are allocated)	
		Communication Port	Set by RS485 communication (Maximum: 115.2kbps)	
Intelligent input terminals	11 terminals (A or B terminal accept a pulse train) FW(Forward rotation)/RV(Reverse rotation), CF1 to CF4(Multi-speed 1 to 4), SF1 to SF7(Multi-speed bit 1 to 7), ADD(Trigger for frequency addition), SCHG(Main/Sub speed reference change), STA(3-wire start)/STP(3-wire stop)/ F/R( 3-wire Forward/reverse), AHD(Analog command holding), FUP(Remote speed up)/FDN(Remote speed down)/UDC(Remote speed data clearing), F-OP(Force operation), SET(2nd-motor), RS(Reset), JG(Jogging), DB(External Dynamic brake), 2CH(2-stage Accel/Decel), FRS(Free-run stop), EXT(External fault), USP(Unattended start protection), CS(Commercial power supply change), SFT(Software lock), BOK(Braking confirmation), OLR(Overload restriction selection), KHC(Accumulated input power clearance), OKHC(Accumulated output power clearance), PID to PID4(PID1 to PID4 disable), PIDC to PIDC4(PID1 to PID4 integration reset), SVC1 to 4(PID1 multistage target value 1 to 4), PRO(PID gain change), PIO1/2(PID output switching 1/2), SLEP(SLEEP condition activation)/WAKE(WAKE condition activation), TL(Torque limit enable), TRQ1/2(Torque limit selection1/2), PPI(P/PI mode selection), CAS(Control gain change), SON(Servo-ON), FOC(Forcing), ATR(Permission of torque control), TBS(Torque bias enable), ORT(Home search function), LAC(LAD cancellation), PCLR(Clearance of position deviation), STAT(pulse train position reference input enable), PUP(Position bias (ADD)), PDN(Position bias (SUB)), CP1 to CP4(Multistage position 1 to 4), ORL(Limit signal of Homing ), ORG(Start signal of Homing), FOT(Forward over travel), ROT(Reverse over travel), SPD(Speed/position switching), PSET(Position data presetting), Mi1 to 11(General-purpose input 1 to 11), PCC(Pulse counter clearing), ECOM(EzCOM activation), PRG(Program RUN), HLD(accel/decel disable), REN(RUN enable), DISP(Display lock), PLA(Pulse count A), PLB(Pulse count B), EMF(Emergency-force drive activation), COK(Contactor check signal), DTR(Data trace start), PLZ(Pulse train input Z), TCH( Teach-in signal)			
Backup supply terminal	P+/P-: DC24V input(Input allowable voltage: 24V±10%)			
Functional safety STO input terminal	2 terminals (Simultaneous input)			
Thermistor input terminal	1 terminal (PTC/NTC resistor allowed)			

\*1) Output frequency range will depend on the motor control method and the motor used. Consult the motor manufacturer for the maximum allowable frequency of the motor when operating beyond 60Hz.

\*2) In case of the control mode is changed and the motor constant is not set appropriately, the desired starting torque cannot be obtained and also exists the possibility of tripping.

\*3) Regarding the speed range regulation of motor, the variable range depends on the client system and the environment in which the motor is used. Please contact Hitachi inverter distributors for more information.

\*4) Both the input power and output power are reference values, which are not appropriate for use in calculation of efficiency values, etc. To obtain an accurate value, use an external device.

\*5) If the IGBT error [E030] occurs by the protective function, it may have happened by the short-circuit protection, but also can occur by the IGBT is damaged. Depending on the operation status of the inverter, instead of the IGBT error, the overcurrent error [E001] may also occur.

\*6) At factory setting, the maximum output frequency for analog input signal Ai1/Ai2 is adjusted to 9.8V for voltage input and 19.6mA for current input. In order to adjust the specification use analog start/end function.

## 7.3 Common specifications (continue)

Output	Intelligent output terminals	Transistor output terminal 5, 1a contact relay 1 point, 1c contact relay 1 point	
	Relay/ Alarm relay (1a, 1c) function	RUN(Running), FA1 to 5(Reached frequency signal), IRDY(Inverter ready), FWR(Forward rotation), RVR(Reverse rotation), FREF(Frequency referenc=Keypad is selected), REF(Run command = Keypad is selected), SETM(2nd-motor selected), OPO(Option-Output), AL(Alarm signal), MJA(Major failure signal), OTQ(Over-torque) *7), IP(Instantaneous power failure), UV(Undervoltage), TRQ(Torque limited), IPS(Decel. Power loss), RNT(Accumulated RUN time over), ONT(Accumulated power-on time over), THM(Motor electronic thermal warning), THC(Iverter Electronic thermal warning), WAC(Capacitor life warning), WAF(Cooling-fan life warning), FR(Starting contact signal), OHF(heat sink overheat warning), LOC/LOC2(Low-current indication signal), OL/OL2(Overload warning signal 1/2), BRK(Brake release)/BER(Brake error)/CON(Contactor control), ZS(Zero speed detection), DSE(Speed deviation over), PDD(Position deviation over), POK(Positioning completed), PCMP(Pulse counter compare match output), OD/OD2/OD3/OD4(Output deviation for PID control), FBV/FBV2/FBV3/FBV4(PID feedback comparison), NDc(Communication line disconnection), Ai1Dc/Ai2Dc/Ai3Dc(Analog Ai1/Ai2/Ai3 disconnection), Ai4Dc/Ai5Dc/Ai6Dc(Option analog Ai4/Ai5/Ai6 disconnection), WCAi1/WCAi2/WCAi3(Window comparator Ai1/Ai2/Ai3), WCAi4/WCAi5/WCAi6(Window comparator Ai4/Ai5/Ai6), LOG1 to 7(logical operation result 1 to 7), MO1 to 7(General-purpose output 1 to 7), EMFC(Emergency force drive indicator), EMBP(Bypass mode indicator), WFT(Trace waiting signal), TRA(Trace running signal), LBK(Low battery of keypad), OVS(Overvoltage power Supply), AC0 to 3( Alarm code bit-0 to 3), SSE( PID soft start error)	
	EDM output terminal	Functional safety diagnostic output	
	Output terminal monitor *8)	The data of the monitor can be selected by the parameter of the output.	
EMC filter *9)		EMC filter can be enable (The filter exchange method can alter depending on the model)	
PC external access		USB Micro-B	
Operating environment	Ambient temperature *14)	ND	-10 to 50°C
		LD	-10 to 45°C
		VLD	-10 to 40°C
	Storage temperature *10)	-20 to 65°C	
	Level of humidity	20 to 90%RH(No condensation allowed)	
	Vibration tolerance *11)	5.9m/s <sup>2</sup> (0.6G), 10 to 55Hz	P1-00044-L(P1-004L) to P1-01240-L(P1-220L)/P1-00041-H(P1-007H) to P1-00620-H( P1-220H) 2.94m/s <sup>2</sup> (0.3G) 10 to 55Hz P1-01530-L(P1-300L) to P1-03160-L(P1-550L)/P1-00770-H(P1-300H) to P1-06600-H(P1-3150H)
Installation place *12)	1000 altitude or lower (location free from corrosive gas, oil mist, and dust)		
Components life span	The design life of the electrolytic capacitor on the board and the main circuit smoothing capacitor is 10 years.		
	The design life of the cooling fan is 10 years (models with cooling fan). But no dust.		
	Non-volatile memory parts on control circuit board.		
Conformity standards *13)	UL, cUL, CE marking, RCM, Functional safety (STO function/ IEC61800-5-2,IEC62061,IEC61508: SIL3/ EN ISO13849-1: Cat.4 PLe) The functional safety certification models are P1-00044-L(P1-004L) to P1-02950-L(P1-550L)/P1-00041-H(P1-007H) to P1-03160-H(P1-1320H). In addition, the certification models for the functional safety option P1-FS are also the same models.		
Coating color	Black (P1-1600HFF and above models are unpainted (but front cover and terminal block cover are black))		
Optional slots	3 ports		
Option cassettes *15)	<ul style="list-style-type: none"> <li>• Communication option : Ethernet(Modbus-TCP)(P1-EN), EtherCAT® (P1-ECT), PROFINET® (P1-PN), PROFIBUS® (P1-PB), CC-Link® (P1-CCL), DeviceNet® (P1-DN)</li> <li>• Encoder Feedback option (Line driver input(RS422))(P1-FB)</li> <li>• Functional safety option(P1-FS)(STO/SS1/SBC/SLS/SDI/SSM function/IEC61800-5-2,IEC62061, IEC61508:SIL3/EN ISO13849-1:Cat.4 PLe )</li> <li>• Analog input/output option (P1-AG)</li> </ul>		
Other optional components	Braking resistor, AC reactor, DC reactor, noise filter,operator cable, harmonics suppression unit, LCRfilter, analog panel, regenerative braking unit, power regeneration converter, SJ300/SJ700 compatible screw type control terminal block option(P1-TM2), PC software ProdriveNext.		

\*7) The threshold for signal output varies depending on the motor to be combined with the inverter, parameter adjustment, etc.

\*8) The analog voltage and analog current monitor are estimated outputs of the analog meter connection. Maximum output value might deviate slightly from 10V or 20mA by variation of the analog output circuit. If you want to change the characteristics, adjust the Ao1 and Ao2 adjustment functions. There are some monitor data that cannot be output.

\*9) In order to enable the EMC filter, connect to the neutral grounding supply. Otherwise, the leakage current may increase.

\*10) Storage temperature is the temperature during transport.

\*11) In accordance with the test methods of JIS C 60068-2-6:2010(IEC 60068-2-6:2007).

\*12) In case of utilization at an altitude of 1000m or more, take into account that the atmospheric pressure is reduced by 1% for every 100m up. Apply 1% derating from the rated current by increasing every 100m, and conduct an evaluation test.  
When using above 2500m ambient, please contact Hitachi Inverter distributor.

\*13) Insulation distance is in accordance with the UL and CE standards.

\*14) Use the 400V class inverter at an input voltage of 500VAC or below. If input voltage exceeds 500VAC due to fluctuation of power, use the inverter at 40°C or lower ambient temperature.

\*15) Modbus® is a registered trademark of Schneider Automation Inc.

EtherCAT® is registered trademark and patented technology, licensed by Beckhoff Automation GmbH, Germany.

PROFIBUS® and PROFINET® is registered trademark of PROFIBUS Nutzerorganisation e.V. (PNO).

CC-Link® is trade names of Mitsubishi Electric Co. DeviceNet® is the trademark of Open DeviceNet Vendor Association, Inc.

---

## 7.4 Current derating

---

For using with carrier frequency over 2.1kHz, or when changing load ratings to LD/VLD, refer to P1 user's guide section "20.4 Current derating table".

(Note: Please contact for models not listed in the user's guide.)

## SJ-P1 Ver.2.01 Supplement

Following supplement contains the explanation of functions added to the Ver.2.01 and supplementary cautions when using this version.

### 【 1 】 Added functions

The following functions were added to the Ver.2.01.

NO.	Function	Ver.2.01	Ver.2.00 or lower
1	Operation panel VOP display language	Can be selected from one of these 7 languages ・ English、 ・ Japanese (日本語)、 ・ French (Français) 、 ・ Spanish (Español)、 ・ Turkish (Türkçe)、 ・ Polish (język polski)、 ・ Czech (český jazyk) [VOP Ver2.01]	Can be selected from one of these 2 languages ・ English、 ・ Japanese (日本語)、 [VOP Ver2.00 or lower]

◆ Setting method . . . select [Menu], [03 System setting] then [01 Language].

(In case the [01 controller] option is selected from the [01 Language] option list, the language will be set to Japanese if the SJ-P1 model number ends in -LFF or HFF, or it will be set to English if the SJ-P1 model number ends in -HFEF, -LFUF or HFUF.)

### 【 2 】 Supplementary cautions

The following modifications were made on the Ver.2.01 based on the Ver.2.00. If settings related to the modifications described below were being used on the Ver.2.00 or lower, then is necessary to reexamine the configuration of these settings.

No.	Content	Item	Ver.2.01	Ver.2.00 or lower
1	Output range modification of the Ao1, Ao2 analog output terminals when used as current outputs.*1	Output current range*2	0~20mA	4~20mA
2	Output logic modification of the Speed deviation over (DSE) output signal.*3 (bb-83 : Speed deviation error detection level)	While stopped	OFF	OFF
		Operating at (bb-83) level or less	OFF	ON
		Operating at more than (bb-83) level	ON	OFF

\*1) Please reexamine the setting of the bias adjustment Cd-23/Cd-33 and the gain adjustment Cd-24/Cd-34.

\*2) Assuming Cd-23/Cd-33=0.0% and Cd-24/Cd-34=100.0%.

\*3) If the same specification as the Ver.2.00 is required, then configure the logical calculation function (CC-40~CC-60) to calculate the XOR of the Speed deviation over (DSE) and the Running (RUN) output signals, then use the logical operation result (LOG) output signal as the Speed deviation over (DSE) output signal. In this case, the speed deviation error detection time setting should be done by using the output terminal off-delay time parameters (CC-21, 23, 25, 27, 29, 31, 33). (In this case the speed deviation error detection time parameter (bb-84) must be set to 0.0s)

## SJ-P1 Ver.2.02 Supplement

Following supplement contains the explanation of the updates implemented in the Ver.2.02.

### [1] Operation panel VOP language support expansion (10 languages support)

Ver.2.02 [VOP Ver. 2.02]	Ver.2.01 [VOP Ver.2.01]
<p>The language can be selected from the 10 options shown below</p> <ul style="list-style-type: none"> <li>·English</li> <li>·Japanese(日本語)</li> <li>·French(Français)</li> <li>·Spanish (Español)</li> <li>·Turkish(Türkçe)</li> <li>·Polish(język polski)</li> <li>·Czech(češský jazyk)</li> <li>·German(Deutsch) ※New addition</li> <li>·Italian(Italiano) ※New addition</li> <li>·Dutch(Nederlands) ※New addition</li> </ul>	<p>The language can be selected from the 7 options shown below</p> <ul style="list-style-type: none"> <li>·English</li> <li>·Japanese(日本語)</li> <li>·French(Français)</li> <li>·Spanish (Español)</li> <li>·Turkish(Türkçe)</li> <li>·Polish(język polski)</li> <li>·Czech(češský jazyk)</li> </ul>

◆Setting method...select [Menu]→[07 System setting]→[01 Language] then choose one of the options shown above.

In case the [01 Controller] option is selected from the [01 Language] option list, the language will be set to Japanese if the SJ-P1 model number ends in -LFF or HFF, or it will be set to English if the SJ-P1 model number ends in -HFEF, -LFUF or HFUF.

### [2] Operation panel VOP menu addition

4 types of function specific parameter menus were added.

Ver.2.02 [VOP Ver.2.02]	Ver.2.01 [VOP Ver.2.01]
<p>The following 7 menus are available</p> <ul style="list-style-type: none"> <li>·01 Scroll mode</li> <li>·02 User mode ※New addition</li> <li>·03 Short menu ※New addition</li> <li>·04 Compare mode ※New addition</li> <li>·05 Motor setup ※New addition</li> <li>·06 Read/Write</li> <li>·07 System setting</li> </ul>	<p>The following 3 menus are available</p> <ul style="list-style-type: none"> <li>·01 Scroll mode</li> <li>·02 Read/Write</li> <li>·03 System setting</li> </ul>

※The operation method and details of the 02 to 05 menus are explained in the section [\[5\]](#)



### 【3】 Parameter addition and specification changes

The addition of new parameters and specification changes of existent parameters were implemented as shown in the tables below.

#### · New parameter addition

Code	Name	Data range	Initial Value	Details
HC115	Torque conversion method selection, 1st-motor	00(Torque)/01(Current)	00	Torque reference percentage value selection
HC215	Torque conversion method selection, 2nd-motor			
oH-40	DeviceNet node address (MAC ID)	0 to 63	0	DeviceNet option designated parameters (These are designed for a future use, please do not change their settings)
oH-41	DeviceNet assembly instance number selection	00(Instance 20,70)/01(Instance 21,71)/02(Instance 100,150)/03(Instance 101,151)/04(Instance 101,153)/05(Instance 110,111)/06(Instance 123,173)/07(Instance 139,159)	00	
oH-42	DeviceNet speed unit selection	00(Hz)/01(min <sup>-1</sup> )	01	
oH-44	DeviceNet flexible Gr. Format selection	00(Gr. A)/01(Gr. B)/02(Gr. C)	00	
oH-45	DeviceNet idle mode action selection	00(Trip)/01(Decel-Trip)/02(Ignore)/03(Free run stop)/04(Decel stop)/	00	

#### · Parameter specification changes

Code	Name	Ver.2.02	Ver.2.01
AH-80	PID soft start time	Data range 0.00 to 600.00 (sec)	Data range 0.00 to 100.00 (sec)
CC-06	Relay output terminal [16] function	Initial value 00 (no)	Initial value 40 (ZS)
Cd-34	[Ao2] Gain adjustment	Initial value 80.0 (%)	Initial value 100.0 (%)
Hb146	Eco drive response adjustment, 1st-motor	No unit display	[%] displayed as unit
Hb246	Eco drive response adjustment, 2nd-motor		

### 【4】 Positioning Speed limit specification change

The speed limit setting for each positioning operation was changed as shown in the table below.

Positioning operation	Ver.2.02	Ver.2.01 Speed limit
Positioning of the orientation function	[AE-12] Speed reference of home search function *1)	[AE-66] Speed limit in APR control
Positioning of the homing function	[AE-72] Low-speed homing speed setting *1)	[AE-66] Speed limit in APR control

\*1) The behavior is the same as the SJ700 inverter

**[ 5 ] Explanation of the new added menus**

**( 1 ) User mode**

- The user mode will display user-registered parameters only. This will allow to quickly access the parameters that are frequently used or are essential to the user.
- Select the "02 User mode" option from the menu screen, then press the SEL(O) to display the main user mode screen.

[Main user mode screen]

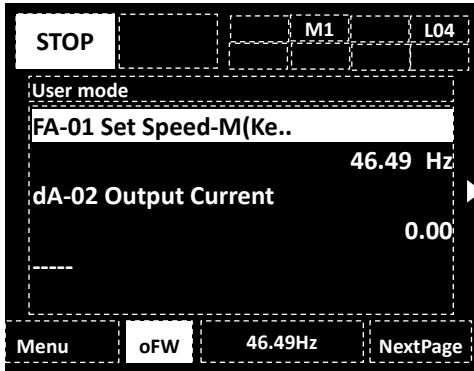

·This user mode screen displays the parameters that have been previously registered on the user parameters [UA-31] to [UA-62] in that order.(「----」 will be displayed in case there is no registered parameter)

**※User mode parameter registration**

- By pressing the RIGHT(▷)button, the screen will move to the parameter registration screen where the parameters UA-31 to UA-64 are displayed.

User mode screen(parameter registration screen)

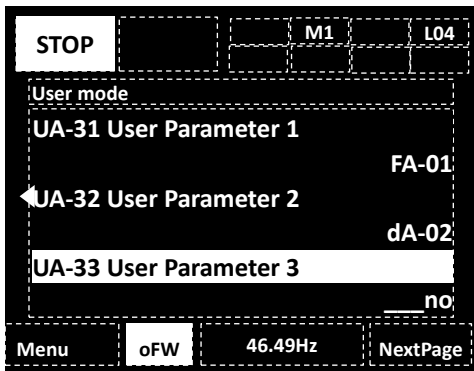

- Use the UP/DOWN(Δ▽)or the F2 key(Next page) to select the required user parameter then press the SEL(O) to display the parameter setting screen, then search and register the required parameter.
- Registering a non-existent parameter will release the registration in that user parameter(「\_\_no」 will be shown instead).

**( 2 ) Short menu**

- The short menu displays regularly used parameters for the inverter operation allowing the user to configure the inverter more quickly and efficiently.
- Select the "03 Short menu" option from the menu screen, then press the SEL(O) to display the short menu screen.

[Short menu Screen]

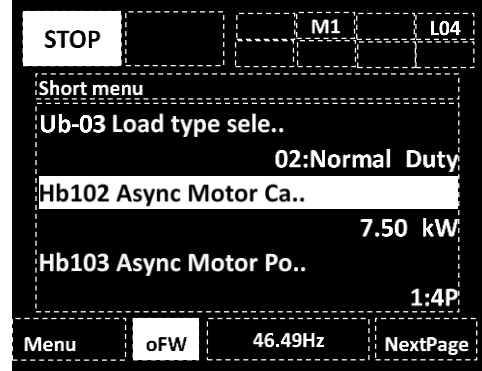

- The short menu will display the parameters shown in the table below. (These are pre-defined parameters for the short menu)

**※Short menu pre-defined parameters**

No	Code	Name
1	Ub-03	Load type selection
2	Hb102	Async. Motor capacity setting, 1st-motor
3	Hb103	Async. Motor number of poles setting, 1st-motor
4	Hb104	Async. Motor base frequency setting, 1st-motor
5	Hb105	Async. Motor maximum frequency setting, 1st-motor
6	Hb106	Async. Motor rated voltage, 1st-motor
7	Hb108	Async. Motor rated current, 1st-motor
8	bC110	Electronic thermal level setting,1st-motor
9	AA121	Control mode selection, 1st-motor
10	bb101	Carrier frequency setting, 1st-motor
11	AA101	Main speed input source selection, 1st-motor
12	AA111	Run-command input source selection, 1st-motor
13	AC120	Acceleration time setting 1, 1st-motor
14	AC122	Deceleration time setting 1, 1st-motor
15	AA115	STOP mode selection, 1st-motor
16	Ab110	Multispeed-0 setting, 1st-motor
17	Ab-11	Multispeed-1 setting
18	Ab-12	Multispeed-2 setting
19	Ab-13	Multispeed-3 setting
20	ba101	Upper frequency limit source selection, 1st-motor
21	ba102	Upper frequency limit, 1st-motor
22	ba103	Lower frequency limit, 1st-motor
23	Cb-40	Thermistor type selection
24	CC-07	Relay output terminal [AL] function
25	CC-06	Relay output terminal [16] function
26	ba-61	Dynamic brake activation selection
27	ba-60	Dynamic brake use ratio
28	ba-63	Dynamic brake resistor value

※The number in the No. column represents the short menu display order

(3) Compare mode

- Only the parameters changed from the initial values are displayed. The initial value of the parameters depends on the [Ub-02] Initialize data selection. This mode makes it easy to check the changed parameters.
- Select the "04 Compare mode" option from the menu screen, then press the SEL(O) to display the compare mode screen.

Compare mode screen

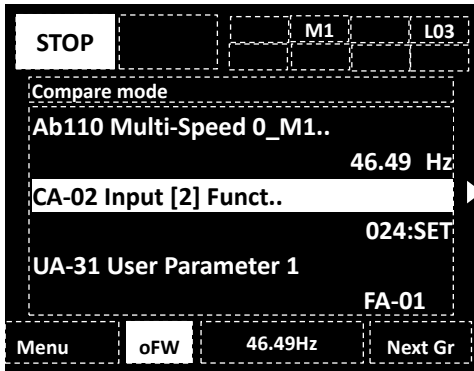

- The compare mode will not display the parameters that have not been modified from their initial settings. Additionally this mode will not display any monitor parameters (Groups d and F).

(4) Motor setup menu

- The motor setup menu displays the parameters that are related to a basic motor setting, allowing the user to quickly configure the inverter to operate a motor.
- Select the "05 Motor setup" option from the menu screen, then press the SEL(O) to display the motor setup screen.

Motor setup screen

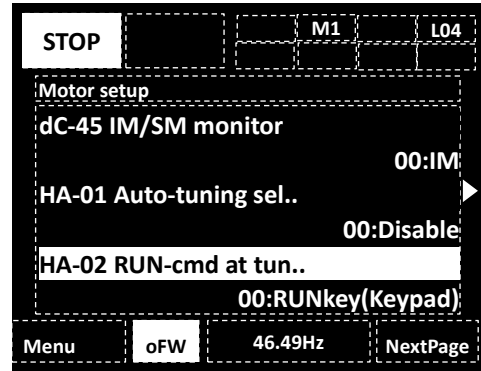

- The motor setup menu will display the parameters shown in the table below. (These are pre-defined parameters for the motor setup menu)

※Motor setup pre-defined parameters

No	Code	Name	No	Code	Name
1	dC-45	IM/SM monitor	21	Hd104	Sync. Motor base frequency setting, 1st-motor
2	HA-01	Auto-tuning selection	22	Hd105	Sync. Motor maximum frequency setting, 1st-motor
3	HA-02	Auto-tuning RUN command source selection	23	Hd106	Sync. Motor rated voltage, 1st-motor
4	HA-03	Online auto-tuning selection	24	Hd108	Sync. Motor rated current, 1st-motor
5	Hb102	Async. Motor capacity setting, 1st-motor	25	Hd110	Sync. Motor constant R, 1st-motor
6	Hb103	Async. Motor number of poles setting, 1st-motor	26	Hd112	Sync. Motor constant Ld, 1st-motor
7	Hb104	Async. Motor base frequency setting, 1st-motor	27	Hd114	Sync. Motor constant Lq, 1st-motor
8	Hb105	Async. Motor maximum frequency setting, 1st-motor	28	Hd116	Sync. Motor constant Ke, 1st-motor
9	Hb106	Async. Motor rated voltage, 1st-motor	29	Hd118	Sync. Motor constant J, 1st-motor
10	Hb108	Async. Motor rated current, 1st-motor	30	Hd130	Minimum frequency adjustment for Sync.M, 1st-motor
11	Hb110	Async. Motor constant R1, 1st-motor	31	Hd131	No-Load current for Sync. M., 1st-motor
12	Hb112	Async. Motor constant R2, 1st-motor	32	Hd132	Starting method for Sync. M., 1st-motor
13	Hb114	Async. Motor constant L, 1st-motor	33	Hd133	IMPE 0V wait number for Sync. M., 1st-motor
14	Hb116	Async. Motor constant I0, 1st-motor	34	Hd134	IMPE detect wait number for Sync. M., 1st-motor
15	Hb118	Async. Motor constant J, 1st-motor	35	Hd135	IMPE detect number for Sync. M., 1st-motor
16	HA110	Stabilization constant, 1st-motor	36	Hd136	IMPE voltage gain for Sync.M, 1st-motor
17	HA115	Speed response, 1st-motor	37	Hd137	IMPE Mg-pole position offset, 1st-motor
18	Hb180	Ouput voltage gain, 1st-motor			
19	Hd102	Sync. Motor capacity setting, 1st motor			
20	Hd103	Sync. Motor number of poles setting, 1st-motor			

※The number in the No. column represents the motor setup menu display order

## SJ-P1 Ver.2.03 Supplement

Following supplement contains the explanation of the updates implemented in the Ver.2.03.

### [1] Added parameters

The following table shows the parameters added in this version upgrade.

Code	Name	Range	Initial Value	Description
bb-50	Frequency matching filter gain	0 to 1000(%)	50	This adjusts the frequency acquisition process filter used during a frequency matching restart.
HA112	Stabilization ramp function end ratio, 1st-motor	0 to 100(%)	30	These adjust the stabilization constant-output frequency characteristic curve
HA212	Stabilization ramp function end ratio, 2nd-motor			
HA113	Stabilization ramp function start ratio, 1st-motor	0 to 100(%)	10	
HA213	Stabilization ramp function start ratio, 2nd-motor			
HC137	Flux settling level, 1st-motor	0.0 to 100.0(%)	80.0	These adjust the magnetic flux settling level at the start of the operation
HC237	Flux settling level, 2nd-motor			
HC140	Forcing level, 1st-motor	0 to 1000(%)	100	These adjust the output current when the forcing function is active
HC240	Forcing level, 2nd-motor			
HC141	Modulation threshold 1, 1st-motor	0 to 133(%)	115	These adjust the upper limit of the output voltage
HC241	Modulation threshold 1, 2nd-motor			
HC142	Modulation threshold 2, 1st-motor	0 to 133(%)	115	
HC242	Modulation threshold 2, 2nd-motor			

#### (1) Frequency matching filter gain [bb-50]

This parameter is used to adjust the filter that is implemented in the motor frequency acquisition process during a frequency matching restart. By decreasing this parameter value the filter time constant increases. The filter will be disabled in case this parameter value is set to 0%. By adjusting this parameter, the operation of the frequency matching restart may be improved in cases where the restart operation is unstable.

#### (2) Stabilization ramp function start ratio [HA113/213], end ratio [HA112/212]

These parameters are used to adjust the stabilization constant - output frequency characteristic curve. When the output frequency is below the start ratio the stabilization constant is 0%, and when it exceeds the end ratio the stabilization constant becomes the [HA110/210] set value. Between the start and end ratio the stabilization constant increases from 0 to [HA110/210] proportionally to the output frequency. See the figure below.

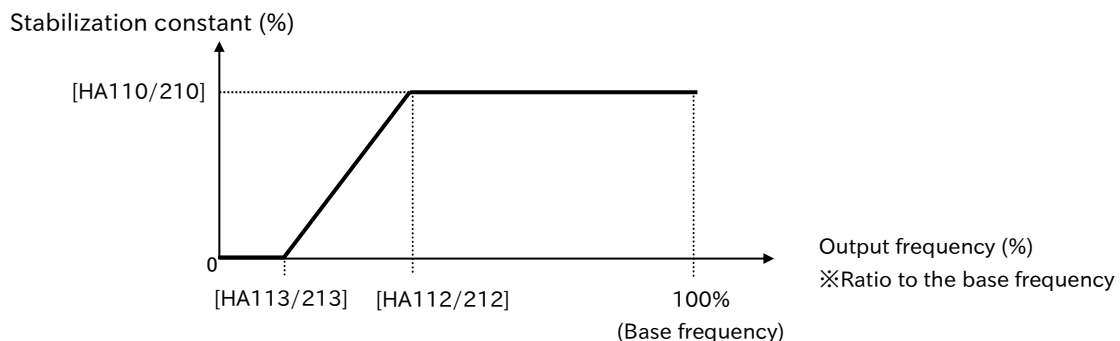

Note) Make sure that the start ratio value is lower than the end ratio value when adjusting these parameters. In case the end ratio is lower than the start ratio, the end ratio setting will be ignored and the start ratio value will be assigned to both the start and end ratio values.

**(3) Flux settling level [HC137/237]**

These parameters are used to adjust the magnetic flux settling level at the start of the operation. Since the acceleration begins when the magnetic flux has reached the level set by these parameters at the start of the operation, the waiting time until the acceleration begins is decreased by setting a smaller value to these parameters. However, changing the setting of these parameters can destabilize the start of the operation.

These parameter settings are effective only when the control mode selection [AA121/221] is set to either 08: Sensorless vector control (IM), 09: Zero-Hz-range sensorless vector control (IM), or 10: Vector control with encoder (IM).

**(4) Forcing level [HC140/240]**

These parameters are used to adjust the output current level while the forcing function is active. These parameter settings are effective only when the control mode selection [AA121/221] is set to either 08: Sensorless vector control (IM), 09: Zero-Hz-range sensorless vector control (IM), or 10: Vector control with encoder (IM). And the basis of these parameters [HC140/240] is applied by the parameters shown in the following table.

Control mode	basis of [HC140/240]
Sensorless vector control (IM), Vector control with encoder (IM)	[Hb116/216] : Async. Motor constant I0
Zero-Hz-range sensorless vector control	[HC110/210] : Zero speed range limit (IM -0Hz-SLV)

In the case the Zero-Hz-range sensorless vector control is being used, and the forcing current is high, the forcing current can be reduced by setting these parameters small.

**(5) Modulation threshold 1,2[HC141/241], [HC142/242]**

These parameters are used to adjust the upper limit of the inverter output voltage. By increasing these parameter values the output current can be reduced. However by applying these settings, the operation can become unstable. Additionally, always make sure that the [HC141] and [HC142] are set to the same value in case these parameter settings need to be changed (same for the 2nd motor parameters [HC241] and [HC242]).

These parameter settings are effective only when the control mode selection [AA121/221] is set to either 08: Sensorless vector control (IM), 09: Zero-Hz-range sensorless vector control (IM), or 10: Vector control with encoder (IM).

**[2] Added pulse train position control and speed control switching function**

When the pulse train position control is enabled ([AA123/223]=01), the control method can be switched to speed control by the SPD terminal.

Changed operation	Ver.2.03	Ver.2.00 to 2.02
The SPD terminal effect regarding the pulse train position control	By turning ON or OFF the SPD terminal the control method is switched as shown below. <ul style="list-style-type: none"> <li>· When SPD is OFF : Pulse train position control</li> <li>· When SPD is ON : Speed control</li> </ul> ※While the SPD is ON the Pulse train position deviation is 0. Hence when changing the SPD from ON to OFF, the deviation is 0 at the beginning of the position control operation.	SPD terminal has no effect.

**[3] Modification of the positioning completed signal [POK] output condition**

The reference position for the positioning completed signal [POK] is modified as shown below.

Changed operation	Ver.2.03	Ver.2.00 to 2.02
The reference position for the POK output signal regarding the absolute position control	The POK signal is output when the aimed target position is reached. In the homing function, the aimed target position is the origin (point zero). In the SON function, the aimed target position is the position where the SON signal is turning on.	The reference for the POK output signal is set by the position reference setting [FA-20].

### Quick start

**DANGER** Thoroughly read “Chapter 1 Safety Instructions” and “Chapter 2 Installation and Wiring” in the P1 Basic Guide for installation and wiring of the inverter.

#### How to use the VOP keypad

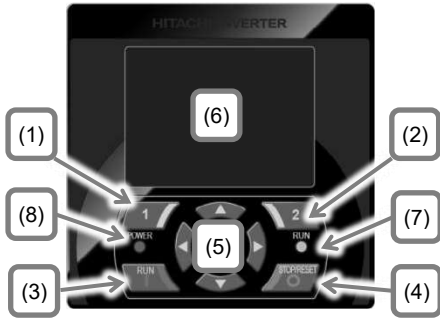

No.	Description
(1)	F1 key Displays the functions in the lower left corner of the screen (e.g. Return to the top page and Cancel).
(2)	F2 key Displays the functions in the lower right corner of the screen (e.g. Data memory).
(3)	RUN key Runs when the key is enabled.
(4)	STOP / RESET key performs deceleration stop and trip reset.
(5)	Selects data on the screen by using the right/left and the up/down arrow keys and confirms the selection by using the O key at the center.
(6)	Display screen
(7)	RUN LED. It turns on when incoming command for operation.
(8)	POWER LED. It turns on when the power is supplied to keypad.

#### How to read the display screen (6)

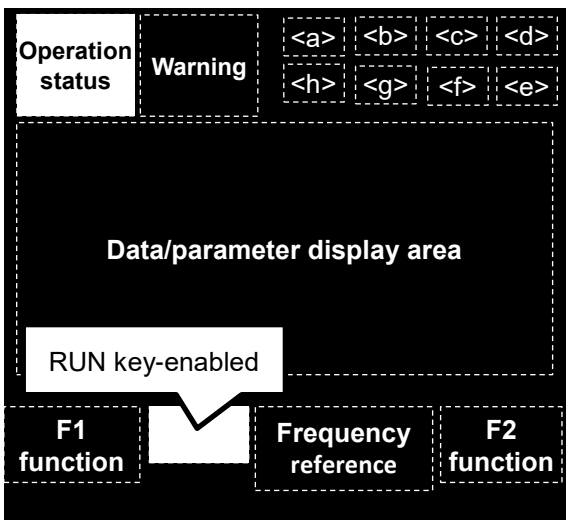

<a>24V supply state, <b> SET function, <c> Parameter display restrictions, <d> Display screen No., <e> Functional safety operation, <f> Command control mode, <g> EzSQ function operation, <h> Special status indication

◇ Part of the keypad screen is shown in below.

#### Frequency setting from keypad

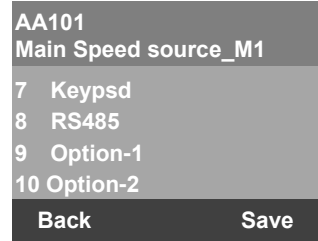

In case of AA101 = 07 set, The frequency reference is set from the Keypad !

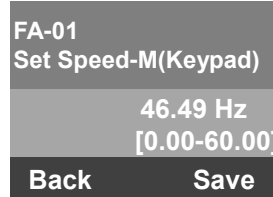

In case of AA101 = 01 set, The frequency reference is set from the Ai1 terminal !

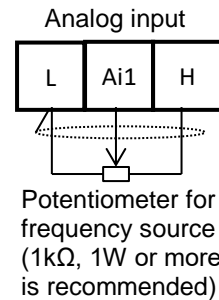

#### Run command setting from keypad

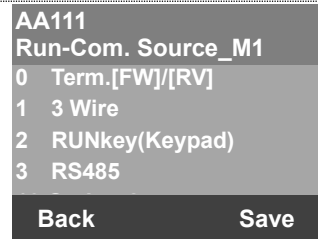

In case of AA111 = 02 set, The run/stop command is set from the keypad !



In case of AA111 = 00 set, The run/stop command is set from the FW/RV terminal !

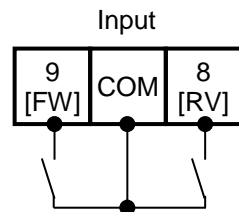

Although there are many functions on the inverter, you do not need to use all the functions. If you need to set functions in more detail, refer to this P1 Basic Guide and P1 User’s Guide.

## Revision History

No	Revision details	Date
NT2511	Initial edition	2016/7
NT2511A	Correction of missing items such as description errors and parameters. (Addition of information on errata NTM251)	2016/7
NT2511A-1	Correction of missing items such as description errors and parameters. (Addition of information on errata NTM251A)	2017/3
NT2511B	Expand product capacity and update parameter list.	2017/3
NT2511B-1	Correction of ambiguous explanation (page 2-3: ventilation fan, page 2-18: wiring method).	2017/4
NT2511B-2	Expand product capacity	2017/5
NT2511C	Correction of missing items such as description errors and parameters. (Addition of information on errata NTM2511B,NTM2511B-1)	2018/9
NT2511D	<ul style="list-style-type: none"> <li>- Added 400V class 160kW to 220kW (P1-03720-H (P1-1600H) to P1-0522-H (P1-2200H)) model dimensions, main circuit terminals, product specifications, etc.</li> <li>- Corrected the position of the main circuit terminal diagram ground in Chapter 2.</li> <li>- Added supplementary explanation of Ver2.02 to the appendix.</li> <li>- Corrected other typographical and description errors.</li> </ul>	2019/7
NT251E	<ul style="list-style-type: none"> <li>- Added 400V class 250kW(P1-05500-H (P1-2500H)), 315kW(P1-06600-H(P1-3150H)) model dimensions, main circuit terminals, product specifications, etc. .</li> <li>- Added supplementary explanation of Ver2.03 to the appendix.</li> <li>- Added Ver2.03 additional parameter to Chapter 4.</li> <li>- Corrected other typographical and description errors.</li> </ul>	2020/2

\*Typographical errors may be corrected without prior notice.

## INDEX

### A

Absolute position control	4-18, 4-38
AC0,AC1,AC2,AC3	4-41
Accel/Decel time dwell	4-21
Acceleration/deceleration curve selection	4-16
Acceleration/deceleration time setting	4-16
Accumulated RUN time	4-11,4-44
Accumulated PowerON time	4-11,4-44
Accumulated input power	4-10, 4-59
Accumulated output power	4-10, 4-59
Action when an error occurs	5-1
Active frequency matching	4-32
ADD	4-13, 4-36
AHD	4-36
Ai1Dc,Ai2Dc,Ai3Dc,Ai4Dc,Ai5Dc,Ai6Dc,	4-44
AL	2-23, 4-40
Analog input adjustment	4-39, 4-53
Analog input/output	2-24
analog input/output adjustment	3-1
Analog output terminal adjustment	4-42, 4-54
Applicable circuit breaker	2-12
Applicable peripheral equipment	2-8
APR	4-19
ASR	4-46
ASR gain mapping	4-46
ASR gain switching	4-46
ATR	4-37
Auto tuning	4-46
Automatic carrier reduction	4-31
Automatic error reset	4-31
Automatic torque boost	4-50
AVR(Automatic output Voltage Regulation)	4-30

### B

Basic parameters for Induction motor	4-47
battery	4-7, 4-59, 5-2
BER	4-20, 4-41
BOK	4-20, 4-36, 5-2
Brake control	4-20
BRD	4-10, 4-30
BRK	4-20, 4-41

### C

capacitor life warning	4-40, 5-3
Carrier frequency	4-31
CAS	4-37, 4-46
CAUTION	1-1
CF1,CF2,CF3,CF4	4-15, 4-36
Checking method for inverter/converter	6-4
CLV	4-14, 4-50
CM1	2-25
COK	4-20, 4-37
Commercial power supply bypass	4-58
commercial supply change	4-32, 4-36
Compliance to European Directive (CE)	1-5
CON	4-20, 4-41
Confirming the status	5-3
constant torque	4-14
Contact Information	5-3
control circuit terminal	2-20

control gain change	4-37
control mode	4-14
Cooling fin overheat warning	4-44
Cooling-fan	4-31
copy	4-7, 4-59
Copying data	4-7
CP1,CP2,CP3,CP4	4-18, 4-37
CS	4-32, 4-36
Current derating	7-4

### D

DANGER	1-1
data comparison display	4-59
DB	4-19, 4-36
DC braking	4-19
DC bus voltage	4-10, 4-30, 4-58, 6-4
Deceleration / stop at power loss	4-30
derating	7-4
Description of monitor	4-10
deviation in position control	4-33
deviation in speed control	4-33
Dimension Drawing	2-5
DISP	4-7, 4-37
Display restriction selection	4-59
DSE	4-33, 4-41
DTR	4-37, 4-60
Dynamic braking	4-30

### E

Eco Drive	4-48
ECOM	4-37, 4-45
electromagnetic sound	4-31
Electronic gear	4-18
Electronic thermal	4-10, 4-33
Electronic thermal warning	4-43
EMBP	4-41, 4-58
EMC Directive	1-5
Emergency-force drive	4-58
EMF	4-37, 4-58
EMFC	4-41, 4-58
encoder	4-38, 4-52
EXT	2-22, 4-36, 5-1
external fault	2-22, 4-36
external thermistor	2-24
EzCOM	4-45
EzSQ	4-61

### F

F/R	3-4, 4-36
FA1	2-23, 4-40
FA2,FA3,FA4,FA5	4-40, 4-43
FAQ/Troubleshooting	5-1
FBV	4-24, 4-41
FBV2	4-26, 4-41
FBV3	4-27, 4-41
FBV4	4-28, 4-41
FDN	4-36, 4-38
FM output	2-25, 4-42
FOC	4-37
F-OP	4-36, 4-38
FOT	4-18, 4-37
FR	3-2, 4-40



# Index

Free V/f ..... 4-14, 4-49  
free-run stop ..... 4-14  
FREF ..... 3-2, 4-40  
Frequency arrival signal ..... 4-43  
Frequency conversion gain ..... 4-15  
frequency matching ..... 4-32  
Frequency reference selection ..... 4-13  
Frequency scale conversion monitor ..... 4-15  
FRS ..... 4-14, 4-32, 4-36  
Functional safety ..... 1-6, 2-25, 4-34, 4-53  
FUP ..... 4-36, 4-38  
FW ..... 3-3, 4-14, 4-36  
FWR ..... 4-40

## G

Ground fault detection ..... 4-32

## H

heat sink ..... 2-3, 4-40, 4-44  
heat sink overheat warning ..... 4-40, 4-44  
HLD ..... 4-21, 4-37  
Home search function ..... 4-18  
Homing ..... 4-19  
How to use the keypad ..... 4-1

## I

Individual Accel/Decel time for Multispeed ..... 4-15, 4-17  
Induction motor constants ..... 4-48  
Initialize ..... 4-60  
Input method for Accel/Decel time ..... 4-15  
Input phase loss ..... 4-33  
Input terminal chatter prevention ..... 3-6, 4-35  
Input terminal function list ..... 4-36  
Input/output voltage, current and power measurement methods ..... 6-6  
Inspection and Maintenance ..... 6-1  
Install the Inverter ..... 2-2  
Insulation resistance test ..... 6-3  
intelligent input terminals ..... 2-22, 4-35  
intelligent output terminals ..... 2-23, 4-39  
IP ..... 4-40  
IPS ..... 4-30, 4-40  
IRDY ..... 2-23, 4-40  
IVMS setting ..... 4-51

## J

J51 connector ..... 2-9  
JG ..... 2-22, 4-21, 4-36  
Jogging ..... 4-21  
jump frequency(resonant frequency avoidance) ..... 4-21

## K

Keypad communication lost ..... 4-59  
Keypad display mode ..... 4-59  
Keypad keys setting ..... 4-14  
KHC ..... 4-36, 4-59

## L

LAC ..... 4-37  
LAD ..... 4-37  
Large monitor ..... 4-4  
LBK ..... 4-41, 4-59  
Lifespan alarm output ..... 6-5  
LOC,LOC2 ..... 4-43  
LOG1,LOG2,LOG3,LOG4,LOG5,LOG6,LOG7 ..... 4-41, 4-42  
Logic output terminals setting ..... 4-42  
low battery warning ..... 4-59  
Low-current detection ..... 4-43  
Lower frequency limit ..... 4-29

## M

Magnetic pole position estimation ..... 4-51  
main circuit terminal block ..... 2-9, 2-15  
Main speed ..... 4-12, 4-13  
major failure ..... 4-40, 5-1, 5-2  
Manual torque boost ..... 4-48  
MI1,MI2,MI3,MI4,MI5,MI6,MI7,MI8,MI9,MI10,MI11 ..... 4-37  
Minimum frequency ..... 4-48, 4-51  
MJA ..... 4-40, 5-1, 5-2  
MO1,MO2,MO3,MO4,MO5,MO6,MO7 ..... 4-41  
Modbus communication ..... 2-26, 4-45  
monitor mode ..... 4-2  
Monitor mode (d code) ..... 4-10  
MOP ..... 4-39, 4-60  
Motor control adjustment gain ..... 4-50  
Motor gear ratio ..... 4-38, 4-52  
Motor stabilization (Hunting) ..... 4-46  
Multi-speed command ..... 4-15  
Multistage input determination time ..... 4-35  
multistage position ..... 4-18, 4-37

## N

NDc ..... 4-41, 4-45  
NO/NC setting ..... 4-35, 4-39

## O

OD ..... 4-24, 4-41  
OD2 ..... 4-26, 4-41  
OD3 ..... 4-27, 4-41  
OD4 ..... 4-28, 4-41  
OHF ..... 4-40, 4-44  
OKHC ..... 4-36, 4-59  
OL,OL2 ..... 4-41, 4-43  
OLR ..... 4-29, 4-36  
Online auto-tuning ..... 4-46  
ONT ..... 4-40, 4-44  
OPO ..... 4-40  
Option parameter display selection ..... 4-59  
Optional cassette error ..... 4-52  
ORG ..... 4-19, 4-37  
ORL ..... 4-19, 4-37  
ORT ..... 4-18, 4-37  
OTQ ..... 4-40, 4-43  
Output phase loss ..... 4-33  
Output terminal function list ..... 4-40  
Output terminals stabilization ..... 3-6, 4-40  
Output voltage adjustment ..... 4-49  
Overcurrent level ..... 4-32

# Index

Overcurrent suppression..... 4-29  
Over-excitation..... 4-30  
Overload detection ..... 4-43  
Overload restriction ..... 4-29  
Over-speed detection ..... 4-33  
Over-torque signal ..... 4-43  
Overvoltage suppression..... 4-30  
Overvoltage warning..... 4-32  
OVS..... 4-32,4-41

## P

P1-AG Analog Input/Output Option..... S-4, 4-53 , 4-54  
P1-CCL CC-Link communication Option..... S-4, 4-52  
P1-DN DeviceNet Communication Option ..... S-4, 4-55  
P1-EN Ethernet communication Option..... S-4, 4-54, 4-57  
P1-FB Encoder Feedback Option ..... S-4, 4-52, 4-53  
P1-FS Functional Safety Option ..... S-4, 4-53  
P1-PB PROFIBUS Communication Option..... S-4, 4-55  
P1-PN PROFINET Communication Option ..... S-4, 4-55  
Parameter arrangement ..... 4-13  
Parameter mode (A code) ..... 4-13  
Parameter mode (b code) ..... 4-29  
Parameter mode (C code) ..... 4-35  
Parameter mode (H code) ..... 4-46  
Parameter mode (o code) ..... 4-52  
Parameter mode (P code) ..... 4-58  
Parameter mode (U code)..... 4-59  
Parameter naming (Nomenclature) ..... 4-13  
Parameter setting screen ..... 4-3  
Password ..... 4-59  
PCC..... 4-37, 4-38  
PCLR ..... 4-33, 4-37  
PCMP..... 4-38, 4-41  
PDD ..... 4-18, 4-41  
PDN ..... 4-18, 4-37  
Permanent Magnet Sync. Motor(SM/PMM)  
    basic parameters ..... 4-51  
PID sleep function ..... 4-25  
PID soft start function ..... 4-24  
PID1..... 4-22, 4-36  
PID1 function ..... 4-22  
PID2..... 4-26, 4-36  
PID2 function ..... 4-26  
PID3..... 4-27, 4-36  
PID3 function ..... 4-27  
PID4..... 4-28, 4-36  
PID4 function ..... 4-28  
PIDC..... 4-23, 4-36  
PIDC2..... 4-26, 4-36  
PIDC3..... 4-27, 4-36  
PIDC4..... 4-28, 4-36  
PIO1..... 4-25, 4-36  
PIO2..... 4-25, 4-36  
PLA ..... 4-18, 4-37, 4-38  
PLB ..... 4-18, 4-37, 4-38  
PLZ..... 4-18, 4-37  
POK ..... 4-18, 4-41  
Position control ..... 4-18  
position saving ..... 4-18  
Positioning operation adjustment ..... 4-19  
Possible errors and solutions ..... 5-5  
PPI ..... 4-37, 4-46  
Pre-set position ..... 4-19  
PRG ..... 4-37, 4-61  
PRO ..... 4-23, 4-36

Product Warranty ..... S-2  
PSET ..... 4-19, 4-37  
Pulse train input..... 4-10, 4-38, 4-53  
Pulse train input counter ..... 4-38  
PUP ..... 4-18, 4-37

## R

Read/Write function ..... 4-7, 4-59  
reduced torque ..... 4-14  
REF..... 3-2, 4-40  
REN ..... 4-37, 5-3  
Reset operation after error ..... 4-31  
Residual risk checklist ..... 2-27  
Resonant frequency avoidance..... 4-21  
Restart mode ..... 4-32  
Restart mode after FRS release..... 4-14, 4-32  
Restart mode after RS release ..... 4-32  
Retry/trip setting in error event ..... 4-31  
Reverse run protection ..... 4-50  
RNT ..... 4-40, 4-44  
ROT ..... 4-18, 4-37  
RS ..... 4-32, 4-36, 4-38  
RUN..... 2-23, 4-40  
RUN command..... 4-14  
RUN command direction restriction ..... 4-14  
RV ..... 3-3,4-14,4-36  
RVR ..... 4-40

## S

Safety Instructions ..... 1-1  
SCHG ..... 4-13, 4-36  
scroll mode ..... 4-8  
Secondary resistor compensation..... 4-50  
sensorless vector control ..... 4-14, 4-50  
Serial communication ..... 2-26  
Servo lock ..... 4-19,4-20,4-37  
SET ..... 4-13, 4-36  
Set the motor data..... 3-1  
SETM..... 4-40, 5-4  
SF1,SF2,SF3,SF4,SF5,SF6,SF7 ..... 4-15, 4-36  
SFT ..... 4-36, 4-59  
Simulation mode..... 4-58  
SLEP ..... 4-25, 4-36  
Slip compensation ..... 4-49, 4-50  
SLV ..... 4-14, 4-50  
Smoothing capacitor life span curve..... 6-5  
Software lock ..... 4-59  
SON ..... 4-37  
SPD..... 4-18, 4-37  
Specification label..... 2-1  
Specifications ..... 7-1  
Speed limitation for torque control ..... 4-17  
Speed response ..... 4-46  
speed/position switching..... 4-18, 4-37  
Sprinkle carrier pattern ..... 4-31  
SSE ..... 4-24, 4-41  
STA ..... 3-4, 4-36  
STAT ..... 4-14, 4-18, 4-37  
STOP mode ..... 4-14  
STP ..... 3-4, 4-36  
Sub speed ..... 4-13  
SVC1,SVC2,SVC3,SVC4 ..... 4-22, 4-36  
System configuration of the keypad ..... 4-7

## T

TBS .....	4-17, 4-37
TCH .....	4-18, 4-37
Teach-in function .....	4-18
Temporary frequency addition .....	4-13
test run .....	4-5
THC .....	4-40, 4-43
Thermistor error .....	4-33, 4-39
THM .....	4-40, 4-43
TL .....	4-29, 4-36
Torque bias .....	4-17
Torque control function .....	4-17
Torque limit .....	4-29
torque monitor .....	4-10
Torque reference value conversion method .....	4-50
TRA .....	4-41, 4-60
Trace function .....	4-60
Trip history screen .....	4-4
TRQ .....	4-29, 4-40
TRQ1,TRQ2 .....	4-29, 4-36

## U

UDC .....	4-36, 4-38
UL standards .....	1-7
unattended start protection .....	2-22, 4-36
Unit selection .....	4-22, 4-26, 4-27, 4-28
Unit table .....	4-22, 4-26, 4-27, 4-28, 4-62
Upper frequency limit .....	4-29
USB node setting .....	4-45
User-parameter setting .....	4-59
USP .....	2-22, 4-36, 5-1
UV .....	4-40

## V

Variable mode monitor (F code) .....	4-12
Vector control start adjustment .....	4-50
vector control with encoder .....	4-14, 4-38, 4-50

## W

WAC .....	4-40, 5-3
WAF .....	4-40, 5-3
WAKE .....	4-25, 4-36
WARNING .....	1-1
WCAi1,WCAi2,WCAi3,WCAi4,WCAi5,WCAi6 .....	4-41, 4-44
WFT .....	4-41
Window comparator .....	4-44, 4-54
wire size .....	2-10
Wiring of the control circuit .....	2-20

## Z

ZS .....	4-41, 4-44
----------	------------

## 0 to 9(Number)

0Hz speed detection .....	4-44
0Hz-SLV .....	4-14, 4-50
24V power supply .....	2-26
2CH .....	4-16, 4-36
2nd-motor parameter display selection .....	4-59
2-stage Accel/Decel time change .....	4-16
3 lines monitor .....	4-4
3WIRE terminal .....	3-4

